



Top II - Indoor

Condizionatori da Tetto - Top mounting A/C - Klimagerät für Dachmontage - Acondicionadores para techo

Caratteristiche Generali

- Capacità frigorifere: 330-5200 W
- Dissipatore di condensa presente da modello ETE14
- Connessioni rapide (eccetto ETE03)
- Termostato digitale ECB (eccetto ETE03)
- Contatti allarme generale e comando remoto forniti come standard (eccetto ETE03)



General Features

- Cooling Capacity 330-5200 W
- Condensate dissipating device from ETE14
- Quick connections (except ETE03)
- Digital thermostat ECB (except ETE03)
- General alarm contacts and remote control as standard (except for ETE03)

Allgemeine Merkmale

- Kälteleistung: 330-5200 W
- Kondensatverdunstung ab ETE14
- Schnellverbindungen (außer ETE03)
- Digital Thermostat ECB (außer ETE03)
- Allgemeine Alarmkontakte und Fernbedienung serienmäßig (außer ETE03)

Características Generales

- Capacidad frigorífica : 330-5200 W
- Dissipador de condensación desde ETE14
- Conexiones rápidas (excepto ETE03)
- Termostato digital ECB (excepto ETE03)
- Contactos de alarma general y el mando a distancia como estándar (excepto en ETE03)

OPTIONAL

CODICE	Colore Speciale	Carpenteria INOX AISI304
CODE	Special Colour	INOX AISI304 Housing
ARTIKELNUMMER	Sonderfarbe	INOX AISI304 Gehäuse
CODIGO	Color Especial	Carcasa INOX AISI304
ETE03	OCAHNS02	OCAHI06
ETE06	OCAHNS03	OCAHI06
ETE09	OCAHNS03	OCAHI06
ETE14	OCAHNS03	OCAHI06
ETE20	OCAHNS03	OCAHI06
ETE28	OCAHNS01	OCAHI28
ETE41	OCAHNS01	OCAHI28
ETE60	OCAHNS01	OCAHI60

ACCESSORI - ACCESSORIES - ZUBEHÖR - ACCESORIOS

CODICE	Filtro
CODE	Filter
ARTIKELNUMMER	Filter
CODIGO	Filtro
ETE03	--
ETE06	ACAFILT06T
ETE09	ACAFILT06T
ETE14	ACAFILT14T
ETE20	ACAFILT14T
ETE28	ACAFILT28T
ETE41	ACAFILT28T
ETE60	ACAFILT60T

Certificazioni - Certifications - Zertifizierungen - Certificaciones

- CE
- UL Recognized (Codice - Code - Artikelnummer - Codigo = ETE--U-----)
- EAC





ETE03

CODICE - CODE - ARTIKELNUMMER - CÒDIGO	M.U.	ETE0300220	ETE0300203
UL Recognized		--	--
Tensione nominale - Rated voltage - Nennspannung - Tensión nominal	V. ~	230 . 1	115 . 1
Frequenza nominale - Nominal frequency - Nennfrequenz - Frecuencia nominal	Hz	50/60	60
Potenza frigorifera - Cooling capacity - Kühlleistung - Potencia frigorífica	L35L35 W	330	330
Potenza frigorifera - Cooling capacity - Kühlleistung - Potencia frigorífica	L35L50 W	270	270
Potenza assorbita - Power consumption - Leistungsaufnahme - Potencia absorbida	L35L50 W	240	240
Corrente assorbita - Current consumption - Stromaufnahme - Corriente absorbida	CE, L35L35 A	1.4	2.8
	UL, L45L55 A	--	--
Corrente di avviamento - Start-up current - Anlaufstrom - Corriente de puesta en marcha	A	5	10
Taratura del dispositivo di protezione - Protection device calibration - Kalibrierung der Schutzeinrichtung - Calibración del dispositivo de protección	A	4	6
Temp. interne di funzionamento - Internal operating temp. - Interne Betriebstemperatur - Temp. internas de funcionamiento	min/ max °C	+25 / +45	+25 / +45
Temp. esterne di funzionamento - External operating temp - Externe Betriebstemperatur - Temp. externas de funcionamiento	min/ max °C	+20 / +55	+20 / +55
Grado di protezione circuito interno - Internal circuit protection rating - Schutzgrad interner Kreislauf - Grado de protección del circuito interno	CE IP	54	54
	UL Type	--	--
Pressione sonora esterna - External sound pressure - Externer Schalldruck - Presión sonora externa	dB(A)	60	60
Altezza / Larghezza / Profondità - Height / Width / Depth - Höhe / Breite / Tiefe - Altura / Anchura / Profundidad	mm	180 x 476 x 324	180 x 476 x 324
Peso - Weight - Gewicht - Peso	kg	17	17

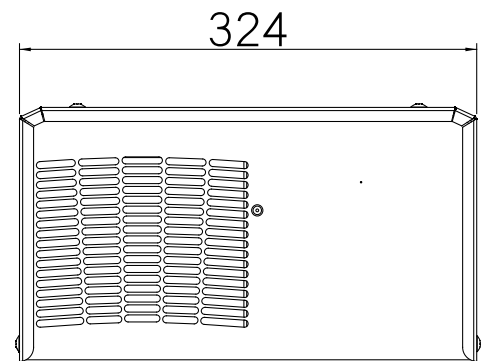
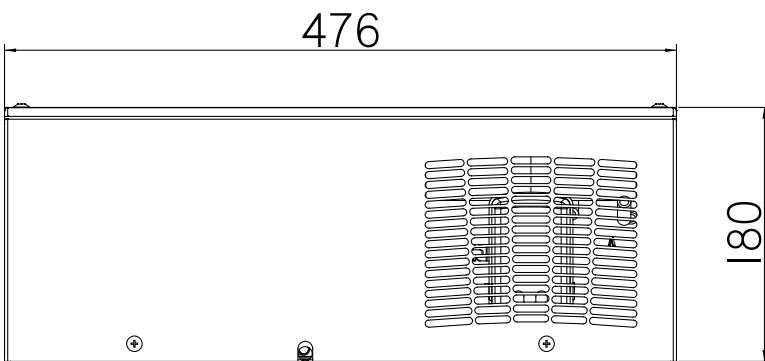

ETE06



CODICE - CODE - ARTIKELNUMMER - CÒDIGO	M.U.	ETE06012207000	ETE06U12207000	ETE06012287000
UL Recognized		--	.	--
Tensione nominale - Rated voltage - Nennspannung - Tensión nominal	V, -	230 . 1	230 . 1	400 . 2 460 . 2
Frequenza nominale - Nominal frequency - Nennfrequenz - Frecuencia nominal	Hz	50/60	50-60	50 60
Potenza frigorifera - Cooling capacity - Kühlleistung - Potencia frigorífica	L35L35 W	600	600	600
Potenza frigorifera - Cooling capacity - Kühlleistung - Potencia frigorífica	L35L50 W	510	510	510
Potenza assorbita - Power consumption - Leistungsaufnahme - Potencia absorbida	L35L50 W	411	411	411
Corrente assorbita - Current consumption - Stromaufnahme - Corriente absorbida	CE, L35L35 A	2,2		1,2
	UL, L45L55 A	--	3	--
Corrente di avviamento - Start-up current - Anlaufstrom - Corriente de puesta en marcha	A	16	16	7,7
Taratura del dispositivo di protezione - Protection device calibration - Kalibrierung der Schutz Einrichtung - Calibración del dispositivo de protección	A	4	4	4
Temp. interne di funzionamento - Internal operating temp. - Interne Betriebstemperatur - Temp. internas de funcionamiento	min/ max °C	+25 / +45	+25 / +45	+25 / +45
	Temp. esterne di funzionamento - External operating temp - Externe Betriebstemperatur - Temp. externas de funcionamiento	min/ max °C	+20 / +55	+20 / +55
Grado di protezione circuito interno - Internal circuit protection rating - Schutzgrad interner Kreislauf - Grado de protección del circuito interno	CE IP	54	54	54
	UL Type	--	--	--
Pressione sonora esterna - External sound pressure - Externer Schalldruck - Presión sonora externa	dB(A)	63	63	63
Altezza / Larghezza / Profondità - Height / Width / Depth - Höhe / Breite / Tiefe - Altura / Anchura / Profundidad	mm	335 x 600 x 325	335 x 600 x 325	335 x 600 x 325
Peso - Weight - Gewicht - Peso	kg	29,5	29,5	32

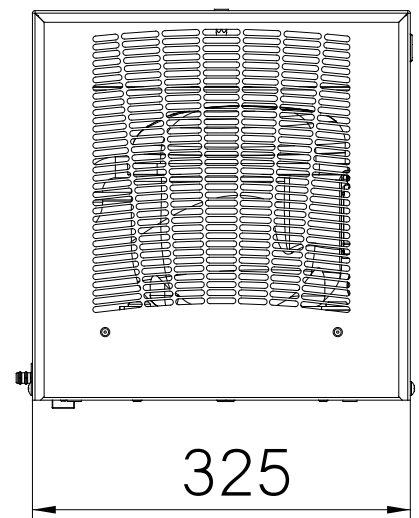
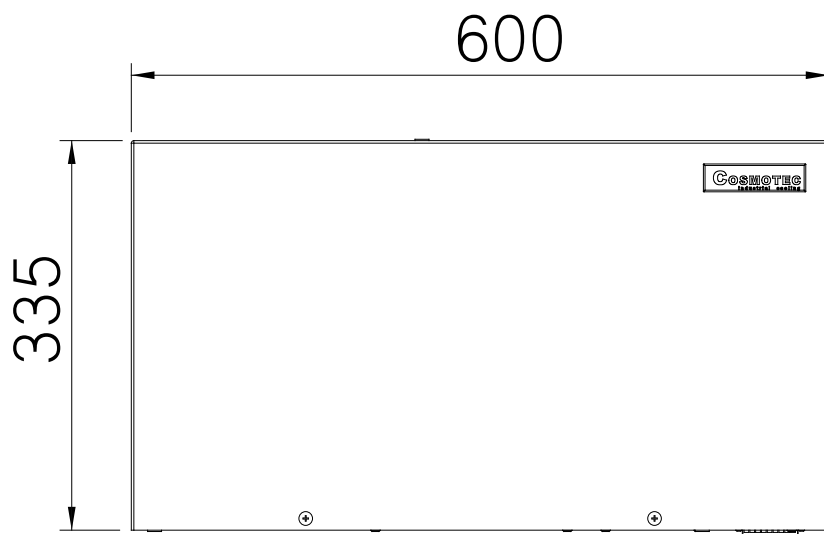



ETE09



CODICE - CODE - ARTIKELNUMMER - CÒDIGO	M.U.	ETE09012207000	ETE09U12207000	ETE09012287000
UL Recognized		--	•	--
Tensione nominale - Rated voltage - Nennspannung - Tensión nominal	V, -	230 . 1	230 . 1	400 . 2 460 . 2
Frequenza nominale - Nominal frequency - Nennfrequenz - Frecuencia nominal	Hz	50/60	50/60	50 60
Potenza frigorifera - Cooling capacity - Kühlleistung - Potencia frigorífica	L35L35 W	900	900	900
Potenza frigorifera - Cooling capacity - Kühlleistung - Potencia frigorífica	L35L50 W	760	760	760
Potenza assorbita - Power consumption - Leistungsaufnahme - Potencia absorbida	L35L50 W	630	630	630
Corrente assorbita - Current consumption - Stromaufnahme - Corriente absorbida	CE, L35L35 A	3.2	--	1.8
	UL, L45L55 A	--	4	--
Corrente di avviamento - Start-up current - Anlaufstrom - Corriente de puesta en marcha	A	15	15--	31
Taratura del dispositivo di protezione - Protection device calibration - Kalibrierung der Schutzeinrichtung - Calibración del dispositivo de protección	A	6	6	6
Temp. interne di funzionamento - Internal operating temp. - Interne Betriebstemperatur - Temp. internas de funcionamiento	min/max °C	+25 / +45	+25 / +45	+25 / +45
Temp. esterne di funzionamento - External operating temp - Externe Betriebstemperatur - Temp. externas de funcionamiento	min/max °C	+20 / +55	+20 / +55	+20 / +55
Grado di protezione circuito interno - Internal circuit protection rating - Schutzgrad interner Kreislauf - Grado de protección del circuito interno	CE IP	54	54	54
	UL Type	--	--	--
Pressione sonora esterna - External sound pressure - Externer Schalldruck - Presión sonora externa	dB(A)	67	67	67
Altezza / Larghezza / Profondità - Height / Width / Depth - Höhe / Breite / Tiefe - Altura / Anchura / Profundidad	mm	335 x 600 x 325	335 x 600 x 325	335 x 600 x 325
Peso - Weight - Gewicht - Peso	kg	31.5	31.5	33

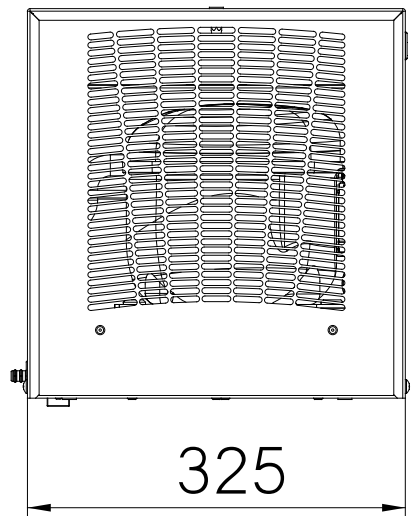
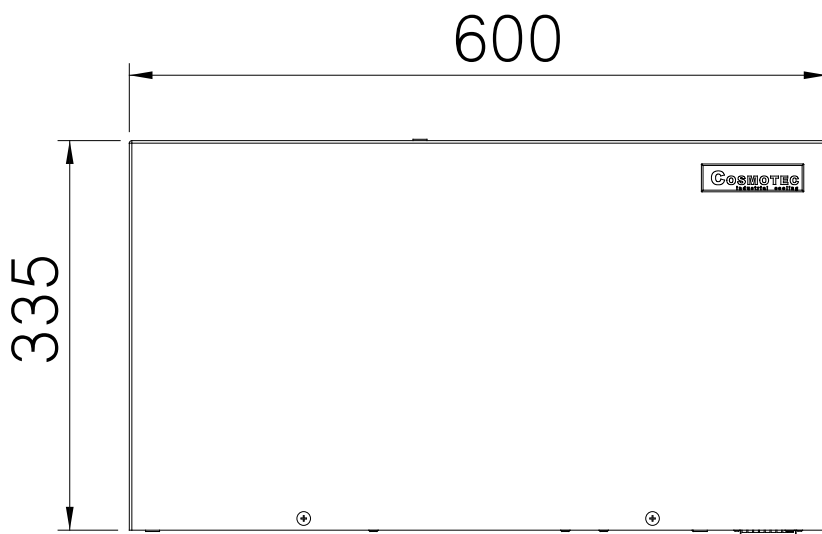

ETE14



CODICE - CODE - ARTIKELNUMMER - CÒDIGO	M.U.	ETE14002207000	ETE14U02207000	ETE14002287000
UL Recognized		--	.	--
Tensione nominale - Rated voltage - Nennspannung - Tensión nominal	V, -	230 . 1	230 . 1	400 . 2 460 . 2
Frequenza nominale - Nominal frequency - Nennfrequenz - Frecuencia nominal	Hz	50/60	50/60	50 60
Potenza frigorifera - Cooling capacity - Kühlleistung - Potencia frigorífica	L35L35 W	1400	1400	1400
Potenza frigorifera - Cooling capacity - Kühlleistung - Potencia frigorífica	L35L50 W	1170	1170	1170
Potenza assorbita - Power consumption - Leistungsaufnahme - Potencia absorbida	L35L50 W	950	950	950
Corrente assorbita - Current consumption - Stromaufnahme - Corriente absorbida	CE, L35L35 A	5,2	--	2,8
	UL, L45L55 A	--	5,5	--
Corrente di avviamento - Start-up current - Anlaufstrom - Corriente de puesta en marcha	A	17	17	31
Taratura del dispositivo di protezione - Protection device calibration - Kalibrierung der Schutzeinrichtung - Calibración del dispositivo de protección	A	8	8	4
Temp. interne di funzionamento - Internal operating temp. - Interne Betriebstemperatur - Temp. internas de funcionamiento	min/max °C	+25 / +45	+25 / +45	+25 / +45
	min/max °C	+20 / +55	+20 / +55	+20 / +55
Grado di protezione circuito interno - Internal circuit protection rating - Schutzgrad interner Kreislauf - Grado de protección del circuito interno	CE IP	54	54	54
	UL Type	--	--	--
Pressione sonora esterna - External sound pressure - Externer Schalldruck - Presión sonora externa	dB(A)	58	58	58
Altezza / Larghezza / Profondità - Height / Width / Depth - Höhe / Breite / Tiefe - Altura / Anchura / Profundidad	mm	450 x 600 x 400	450 x 600 x 400	450 x 600 x 400
Peso - Weight - Gewicht - Peso	kg	48	48	53

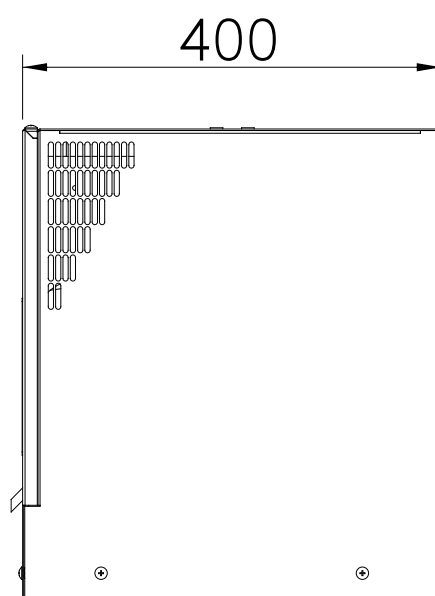
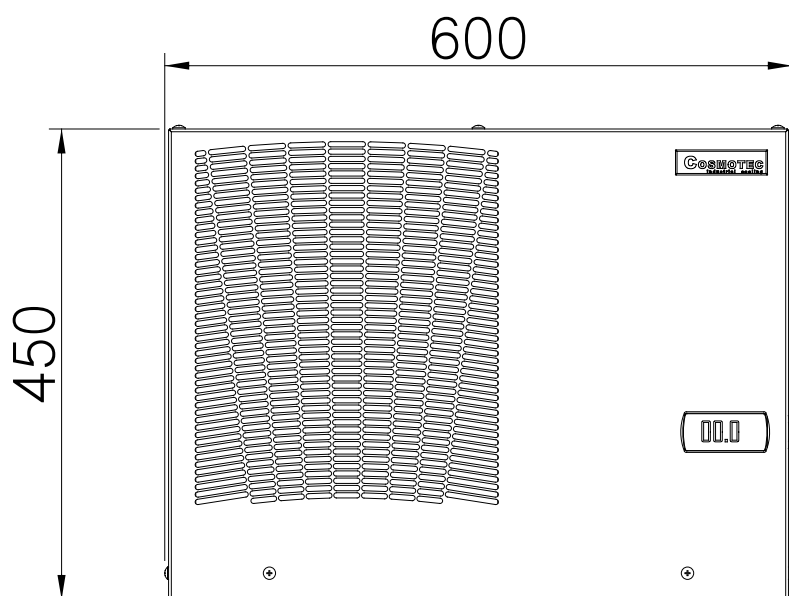



ETE20



CODICE - CODE - ARTIKELNUMMER - CÒDIGO	M.U.	ETE20002207000	ETE20U02207000	ETE20002287000
UL Recognized		--	.	--
Tensione nominale - Rated voltage - Nennspannung - Tensión nominal	V, ~	230 . 1	230 . 1	400 . 2 460 . 2
Frequenza nominale - Nominal frequency - Nennfrequenz - Frecuencia nominal	Hz	50/60	50/60	50 60
Potenza frigorifera - Cooling capacity - Kühlleistung - Potencia frigorífica	L35L35 W	2000	2000	2000
Potenza frigorifera - Cooling capacity - Kühlleistung - Potencia frigorífica	L35L50 W	1700	1700	1700
Potenza assorbita - Power consumption - Leistungsaufnahme - Potencia absorbida	L35L50 W	1200	1200	1200
Corrente assorbita - Current consumption - Stromaufnahme - Corriente absorbida	CE, L35L35 A	5.7	--	3.3
	UL, L45L55 A	--	7	--
Corrente di avviamento - Start-up current - Anlaufstrom - Corriente de puesta en marcha	A	22	22	31
Taratura del dispositivo di protezione - Protection device calibration - Kalibrierung der Schutzeinrichtung - Calibración del dispositivo de protección	A	8	10	10
Temp. interne di funzionamento - Internal operating temp. - Interne Betriebstemperatur - Temp. internas de funcionamiento	min/ max °C	+25 / +45	+25 / +45	+25 / +45
	Temp. esterne di funzionamento - External operating temp - Externe Betriebstemperatur - Temp. externas de funcionamiento	min/ max °C	+20 / +55	+20 / +55
Grado di protezione circuito interno - Internal circuit protection rating - Schutzgrad interner Kreislauf - Grado de protección del circuito interno	CE IP	54	54	54
	UL Type	--	--	--
Pressione sonora esterna - External sound pressure - Externer Schalldruck - Presión sonora externa	dB(A)	62	62	62
Altezza / Larghezza / Profondità - Height / Width / Depth - Höhe / Breite / Tiefe - Altura / Anchura / Profundidad	mm	450 x 600 x 400	450 x 600 x 400	450 x 600 x 400
Peso - Weight - Gewicht - Peso	kg	51.5	51.5	58.5

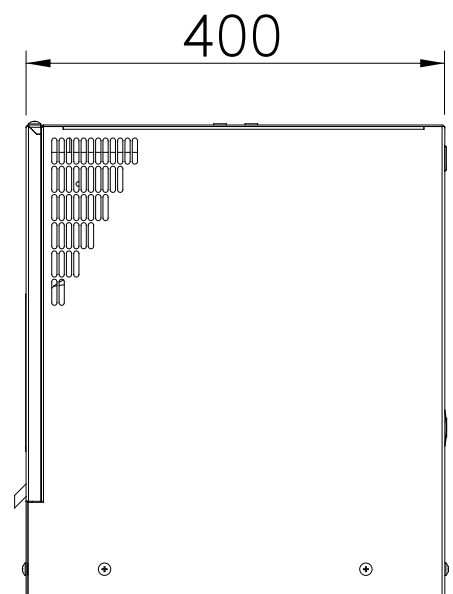
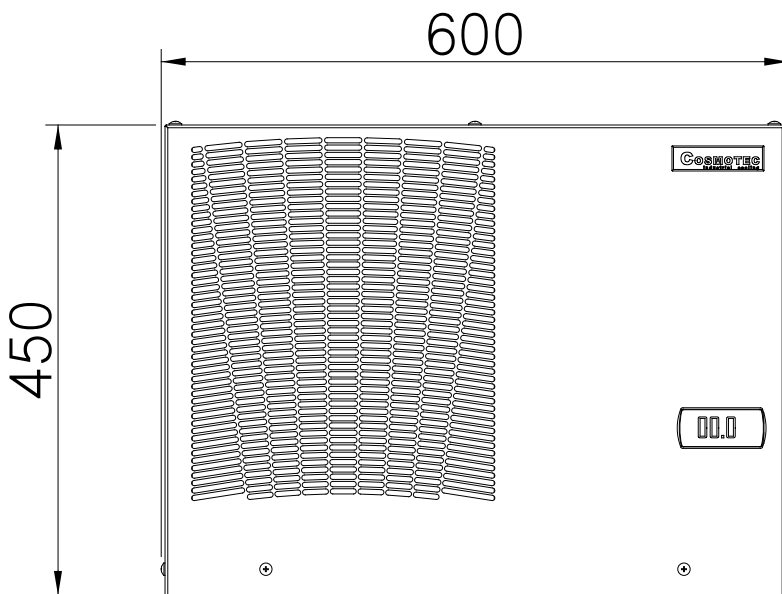

ETE28



CODICE - CODE - ARTIKELNUMMER - CÒDIGO	M.U.	ETE28002207000	ETE28U02207000	ETE28002617000
UL Recognized		--	.	--
Tensione nominale - Rated voltage - Nennspannung - Tensión nominal	V, -	230 . 1	230 . 1	400 . 3 460 . 3
Frequenza nominale - Nominal frequency - Nennfrequenz - Frecuencia nominal	Hz	50/60	50/60	50 60
Potenza frigorifera - Cooling capacity - Kühlleistung - Potencia frigorífica	L35L35 W	2700	2700	2700
Potenza frigorifera - Cooling capacity - Kühlleistung - Potencia frigorífica	L35L50 W	2300	2300	2300
Potenza assorbita - Power consumption - Leistungsaufnahme - Potencia absorbida	L35L50 W	1580	1660	1580
Corrente assorbita - Current consumption - Stromaufnahme - Corriente absorbida	CE, L35L35 A	7	--	2,3
	UL, L45L55 A	--	9,5	--
Corrente di avviamento - Start-up current - Anlaufstrom - Corriente de puesta en marcha	CE A	38	38	16
Taratura del dispositivo di protezione - Protection device calibration - Kalibrierung der Schutzeinrichtung - Calibración del dispositivo de protección	CE A	12	12	6
Temp. interne di funzionamento - Internal operating temp. - Interne Betriebstemperatur - Temp. internas de funcionamiento	min/max °C	+25 / +45	+25 / +45	+25 / +45
	Temp. esterne di funzionamento - External operating temp. - Externe Betriebstemperatur - Temp. externas de funcionamiento	min/max °C	+20 / +55	+20 / +55
Grado di protezione circuito interno - Internal circuit protection rating - Schutzgrad interner Kreislauf - Grado de protección del circuito interno	CE IP	54	54	54
	UL Type	--	--	--
Pressione sonora esterna - External sound pressure - Externer Schalldruck - Presión sonora externa	dB(A)	77	77	77
Altezza / Larghezza / Profondità - Height / Width / Depth - Höhe / Breite / Tiefe - Altura / Anchura / Profundidad	mm	480 x 800 x 450	480 x 800 x 450	480 x 800 x 450
Peso - Weight - Gewicht - Peso	kg	74,5	74,5	76,5

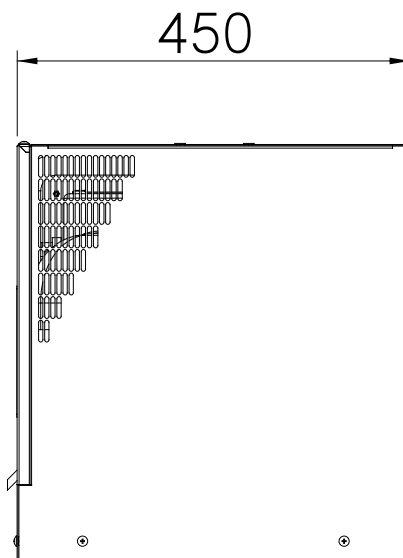
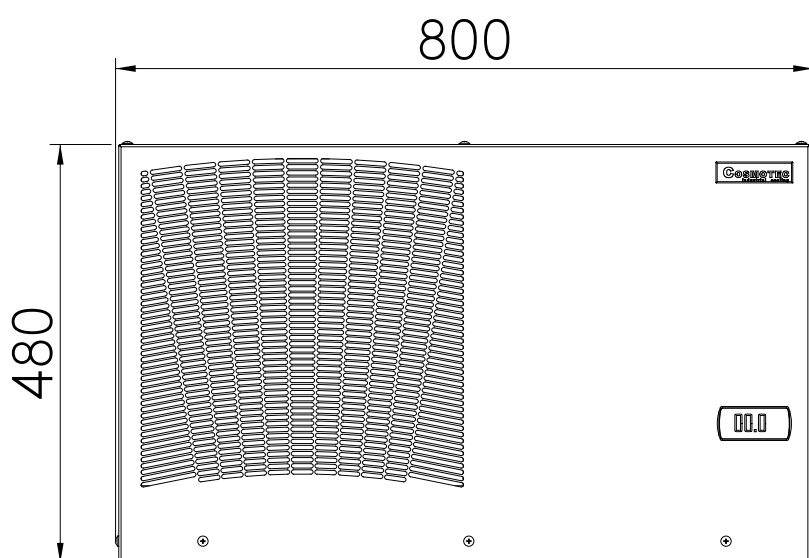



ETE41



CODICE - CODE - ARTIKELNUMMER - CÒDIGO		M.U.	ETE41002207000	ETE41U02207000	ETE41002617000	ETE41U02627200
UL Recognized			--	•	--	•
Tensione nominale - Rated voltage - Nennspannung - Tensión nominal		V. -	230 . 1	230 . 1	400 . 3 460 . 3	400 . 3 460 . 3
Frequenza nominale - Nominal frequency - Nennfrequenz - Frecuencia nominal		Hz	50/60	50/60	50 60	50 60
Potenza frigorifera - Cooling capacity - Kühlleistung - Potencia frigorífica		L35L35 W	3800	3800	3800	3800
Potenza frigorifera - Cooling capacity - Kühlleistung - Potencia frigorífica		L35L50 W	2700	2700	2700	2700
Potenza assorbita - Power consumption - Leistungsaufnahme - Potencia absorbida		L35L50 W	2000	2050	2000	1920
Corrente assorbita - Current consumption - Stromaufnahme - Corriente absorbida		CE, L35L35 A	9	--	2,9	--
		UL, L45L55 A	--	9	--	3,5
Corrente di avviamento - Start-up current - Anlaufstrom - Corriente de puesta en marcha		CE A	38	--	17	--
Capacità di carico minima del circuito - Circuit minimum load capacity - Mindestbelastbarkeit des Kreislaufs - Capacidad de carga mínima del circuito		UL A	--	38	--	62
Taratura del dispositivo di protezione - Protection device calibration - Kalibrierung der Schutz Einrichtung - Calibración del dispositivo de protección		CE A	16	--	8	--
		UL A	--	16	--	8
Temp. interne di funzionamento - Internal operating temp. - Interne Betriebstemperatur - Temp. internas de funcionamiento		min/max °C	+25 / +45	+25 / +45	+25 / +45	+25 / +45
Temp. esterne di funzionamento - External operating temp. - Externe Betriebstemperatur - Temp. externas de funcionamiento		min/max °C	+20 / +55	+20 / +55	+20 / +55	+20 / +55
Grado di protezione circuito interno - Internal circuit protection rating - Schutzgrad interner Kreislauf - Grado de protección del circuito interno		CE IP	54	54	54	54
		UL Type	--	--	--	--
Pressione sonora esterna - External sound pressure - Externer Schalldruck - Presión sonora externa		dB(A)	77	77	77	77
Altezza / Larghezza / Profondità - Height / Width / Depth - Höhe / Breite / Tiefe - Altura / Anchura / Profundidad		mm	480 x 800 x 450	480 x 800 x 450	480 x 800 x 450	480 x 800 x 450
Peso - Weight - Gewicht - Peso		kg	76,5	76,5	79,5	76,5

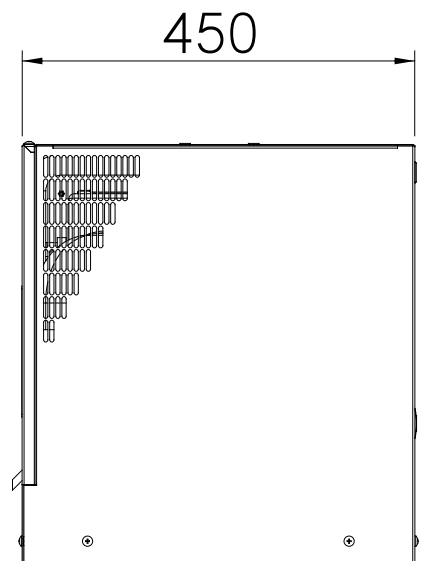
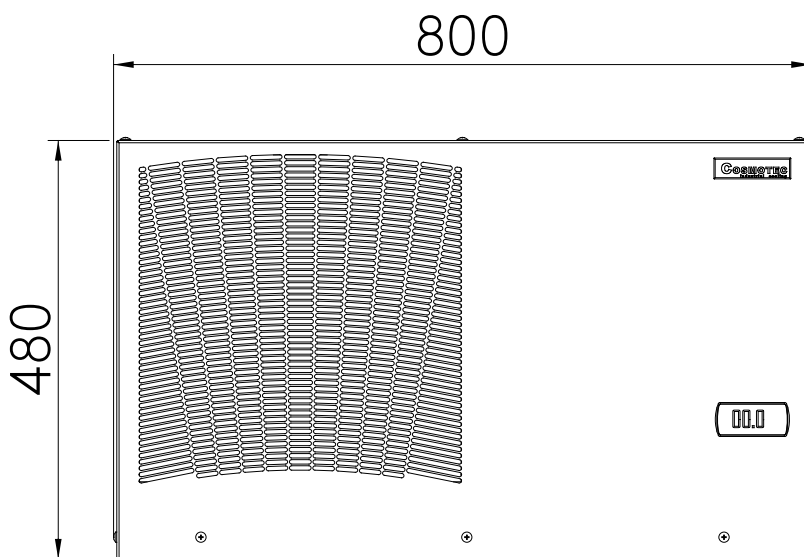

ETE60



CODICE - CODE - ARTIKELNUMMER - CÒDIGO	M.U.	ETE60002617000	
UL Recognized		--	
Tensione nominale - Rated voltage - Nennspannung - Tensión nominal	V, ~	400, 3	460, 3
Frequenza nominale - Nominal frequency - Nennfrequenz - Frecuencia nominal	Hz	50	60
Potenza frigorifera - Cooling capacity - Kühlleistung - Potencia frigorífica	L35L35	W	5200
Potenza frigorifera - Cooling capacity - Kühlleistung - Potencia frigorífica	L35L50	W	4100
Potenza assorbita - Power consumption - Leistungsaufnahme - Potencia absorbida	L35L50	W	2540
Corrente assorbita - Current consumption - Stromaufnahme - Corriente absorbida	CE, L35L35	A	4,6
	UL, L45L55	A	--
Corrente di avviamento - Start-up current - Anlaufstrom - Corriente de puesta en marcha	A	25	
Taratura del dispositivo di protezione - Protection device calibration - Kalibrierung der Schutzeinrichtung - Calibración del dispositivo de protección	A	10	
Temp. interne di funzionamento - Internal operating temp. - Interne Betriebstemperatur - Temp. internas de funcionamiento	min/ max	°C	+25 / +45
Temp. esterne di funzionamento - External operating temp. - Externe Betriebstemperatur - Temp. externas de funcionamiento	min/ max	°C	+20 / +55
Grado di protezione circuito interno - Internal circuit protection rating - Schutzgrad interner Kreislauf - Grado de protección del circuito interno	CE	IP	54
	UL	Type	--
Pressione sonora esterna - External sound pressure - Externer Schalldruck - Presión sonora externa		dB(A)	77
Altezza / Larghezza / Profondità - Height / Width / Depth - Höhe / Breite / Tiefe - Altura / Anchura / Profundidad	mm	550 x 800 x 600	
Peso - Weight - Gewicht - Peso	kg	94	

