

xQR41V Series Needle Valve

Needle valve system for precise, consistent fluid control

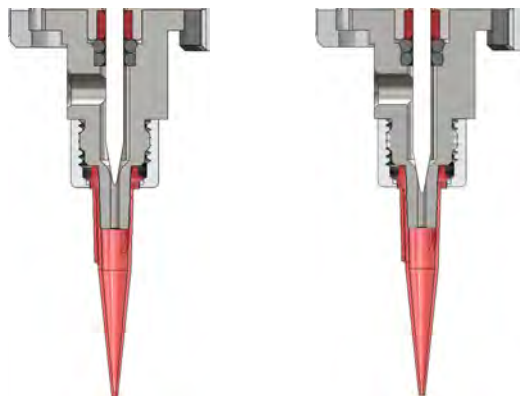

The xQR41V can be used with any Nordson EFD dispense tips to apply a wide range of fluids.



Valve open

Valve closed

Featuring unique QR (Quick Release) technology, a 60% smaller form factor, and an exchangeable modular design, the xQR41V Series needle valve offers an expanded level of customization specific to your dispensing application needs. The smaller dimensions allow the xQR41V valve to dispense in tighter spaces and at more complex angles. The flexibility to mount more valves per fixture plate provides greater output per batch.

The xQR41V provides precise, consistent deposit control of fluids, including silicone oils, solvents, and UV-cure adhesives, in accurate, repeatable amounts. The xQR41V can be used with the full range of Nordson EFD tips, including general purpose tips and SmoothFlow™ tapered tips, making it suitable for a wide range of fluid viscosities.

The patented, tool-free QR clasp design allows for easy removal of the fluid body to replace wetted parts within seconds. Configure the xQR41V valve with a Backpack™ actuator or mounting block to quickly meet requirements specific to your applications.

Features

- 60% smaller form factor than conventional needle dispense valves
- Use with the full range of Nordson EFD dispensing tips

With Backpack

- High-speed cycle capability — cycle rate exceeds 60–80Hz
- Actuation speed as low as 5–6 milliseconds
- State-of-the-art, fast-acting miniature solenoid technology

Benefits

- Modular design provides infinite configurability for greater flexibility
- QR (Quick Release) clasp allows fast, easy serviceability
- Low retained volume in fluid body reduces fluid waste
- 360° rotational fluid body movement allows optimal positioning



more info



xQR41V Series Needle Valve Technology

Exchangeable modular design provides an expanded level of customization for your specific dispensing applications.

BackPack Valve Actuator

Select for fast, precision dispensing.



Syringe Barrel Mounting Bracket

Select for additional 30/55cc syringe barrel support.



Mounting Block

Select for dispensing lines, stripes, and larger deposits.



90° Fluid Inlet Fitting

Select for syringe barrel feed.



Dispensing Tip

Select the best tip from the full range of Nordson EFD tips.



Straight Fluid Inlet Fitting

Select for external cartridge or tank reservoir feed supply.







xQR41V Valve Series

Specify Part # to Order

Part #	Description
7362489	xQR41V valve with BackPack and stroke control knob
7362488	xQR41V valve with mounting block and stroke control knob

Replacement Parts

Partial listing of exchangeable components only. Consult EFD for full listing of available parts.

	Part #	Description	Comment
	7361396	xQR41V BackPack actuator	BackPack actuator complete with air hose, 4 W solenoid, and cable assembly
	Part #	Description	Comment
	7361397	xQR41V mounting block	Mounting block complete with 4 mm push-in fitting and air hose
	Part #	Description	Comment
	7020671	M5 x 4.0 mm barb fitting	For external cartridge or tank feed supply reservoirs
	Part #	Description	Comment
	7361404	Barrel support bracket	Select for additional 30/55cc syringe barrel support
	Part #	Description	Comment
	7361411	90° luer inlet fitting	Select for direct syringe barrel feed connection

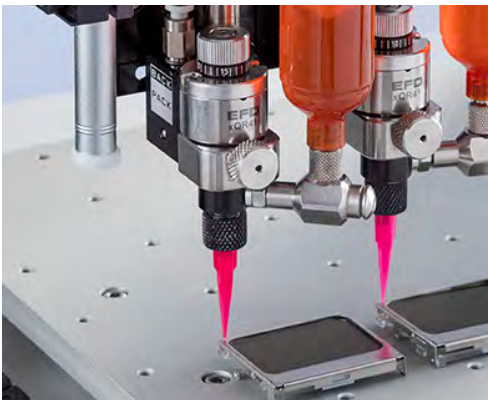

The BackPack actuator and mounting block are made of lightweight materials for easy end-of-arm installation and feature a compact, low-profile design that facilitates center-to-center mounting.



Specifications

xQR41V Series Valve

Item	Specifications
Size	64 mm length x 23.7 mm diameter (2.5 x 0.93")
Weight	Valve only: 115 g (4.1 oz) With Backpack actuator: 170 g (6.0 oz) With mounting block: 140 g (4.9 oz)
Actuating air pressure required	4.8–6.2 bar (70–90 psi)
Maximum fluid pressure	7.0 bar (100 psi)
Fluid inlet	M5
Fluid outlet	Luer taper with retaining nut
Mounting	M4 (BackPack valve actuator or mounting block)
Cycle rate	Exceeds 400 per minute
Air cylinder body	303 stainless steel
Fluid body	PEEK (Polyetheretherketone)
Piston	303 stainless steel
Needle	303 stainless steel
Tip retaining nut	Hard-coated aluminum
Maximum operating temperature	80° C (176° F)
US Patent No. 9,816,849 for QR clasp	
All stainless steel parts are passivated.	

BackPack Valve Actuator

Item	Specifications
Size	26.2W x 26.7H x 18.4L mm (1.03W x 1.05H x 0.72L")
Weight	Valve actuator only: 53.8 g (1.9 oz)
Actuating air pressure required	4.8–6.2 bar (70–90 psi)
Input voltage	24 VDC, 4 W
Minimum actuation time	5 ms
Maximum actuation time	Continuous ON
Operating frequency	60–80Hz
Housing	Anodized aluminum
Mounting bolt	303 stainless steel
All stainless steel parts are passivated.	

Mounting Block Actuating Air Inlet

Item	Specifications
Size	18.4W x 21.6H x 21.4L mm (0.72W x 0.85H x 0.84L")
Weight	Mounting block only: 25.0 g (0.9 oz)
Housing	Anodized aluminum
Mounting bolt	303 stainless steel

All stainless steel parts are passivated.

Select Your Controller

See the Valve Selection Guide for the controllers compatible with this valve — www.nordsonefd.com/ValveGuide.

Automated Dispensing Systems

Nordson EFD automated dispensing systems deliver market-leading repeatability and accuracy in fluid placement and positioning. Specialized dispensing software simplifies setup and programming. Optimize dispensing results with features such as laser height sensing and smart vision CCD cameras.

Request a Process Evaluation

Contact Nordson EFD to configure a precision dispense system that meets your specific needs, with:

- A complimentary process evaluation by experienced fluid dispensing experts.
- Samples processed for customer evaluation and approval prior to purchase.



For Nordson EFD sales and service in over 40 countries, contact Nordson EFD or go to www.nordsonefd.com.

Global

East Providence, RI USA
800-556-3484; +1-401-431-7000
info@nordsonefd.com

Europe

Dunstable, Bedfordshire, UK
0800 585733; +44 (0) 1582 666334
europe@nordsonefd.com

Asia

China: +86 (21) 3866 9006; china@nordsonefd.com
India: +91 80 4021 3600; india@nordsonefd.com
Japan: +81 03 5762 2760; japan@nordsonefd.com
Korea: +82-31-736-8321; korea@nordsonefd.com
SEAsia: +65 6796 9522; sin-mal@nordsonefd.com