



Modular Construction Kit for Factory Automation



Profile Technology. Conveyor Technology. System Solutions.

Company Profile



» Our passion for technology has driven us for over 50 years. «

For over 50 years, we have been driven by our motto: "passion for technology". Together with our company values – ambition, know-how and dependability – passion for technology is at the core of mk and forms the foundation for our decisions and everyday operations. This drives us to continuously develop our products and services to satisfy our customers to the best of our ability.

Ambition

Our constant challenge is to find the perfect solution to a particular set of problems, and it is a challenge we gladly accept. We are also driven by the desire to constantly improve our products, services and processes to maximise their benefits for the customer.

Know-How

Our know-how is based on decades of experience working with factory automation modules and components, on the continuous re-innovation and improvement of our products, on expertise in providing solutions for nearly every industry, and on a team of talented and ambitious employees.

Dependability

Dependability for us is about more than just maintaining deadlines and quality standards. It's about being fair and reliable in our interactions with customers, and always taking their needs into account. You can depend on us. We always keep our word.

mk Locations

Maschinenbau Kitz, the parent company of the mk Technology Group, is one of the leading suppliers of components, modules and systems for factory automation. With our dense production sales and service network consisting of subsidiaries, sales partners and external service providers, we guarantee our customers

fast access to our expert advice and outstanding products. Our more than 450 highly qualified and dedicated employees work to fulfil customer orders with precision and dependability in over 28,000 m² of production area space.

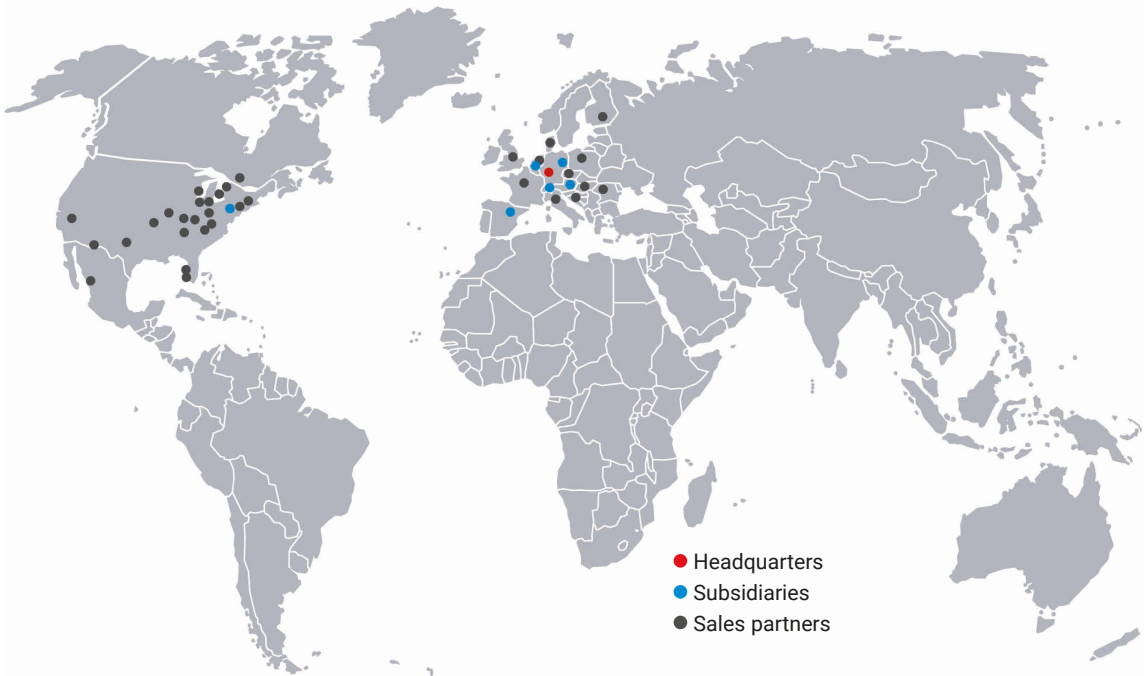

- Headquarters
- Subsidiaries
- Sales partners

Headquarters

Maschinenbau Kitz GmbH
 Ampèrestrasse 18
 53844 Troisdorf, Germany
info@mk-group.com
www.mk-group.com

Subsidiaries

mkf GmbH
 Lindenstrasse 1
 07589 Lederhose, Germany
info@mkf-automation.de
www.mkf-automation.de

mk North America Inc.
 105 Highland Park Drive
 Bloomfield, CT 06002, USA
info@mknorthamerica.com
www.mknorthamerica.com

mk Kitz Hispania S.L.
 C/Peña Oroel, s/n.
 50410 Cuarte de
 Huerva (Zaragoza),
 Spain
info@mkhispania.es
www.mkhispania.es

mk Products B.V.
 Windmolen 12
 7609 NN Almelo,
 Netherlands
info@mkproducts.nl
www.mkproducts.nl

E-M-M-A GmbH
 IZ Nö Süd Strasse 2a/M8
 2351 Wr. Neudorf, Austria
info@e-m-m-a.eu
www.e-m-m-a.eu

Promec Automation AG
 Rolliweg 21
 2543 Lengnau, Switzerland
info@promec-automation.ch
www.promec-automation.ch

Industry

Automotive Industry



Precise parts handling in accordance with standards

Battery Production and E-mobility

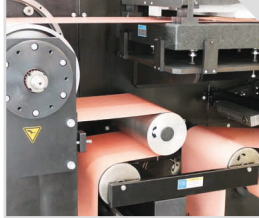

High reliability and cost efficiency

Packaging Industry



Flexible and modular machine construction for maximum diversity of variants

Food and Beverage Industry



Gentle and sanitary transport of sensitive product

Plastics Industry



Reliable conveyor technology for interlinking and production

Electrical and Medical Technology



Secure and reliable handling per customer standards

Logistics and Material Flows



Automated material flows with short throughput times

Machine and System Construction



High-quality transport systems starting at batch size 1

Consumer Goods Industry



Gentle transport of packaged and unpackaged products

Research & Development



From the laboratory to real-world applications

Tools and Configurators

Helpful tools and configurators at www.mk-group.com



Online Product Filters

We offer a suitable conveyor system for virtually any transported products and operating conditions. Simply enter your parameters and the product filter will show you suitable systems.



Web Shop

In our web shop, you will find components from our varied and proven profile system.



CAD Data*

Reduce your planning and design time using the CAD data of all products for the profile system and selected products from conveyor and linear technology.



QuickDesigner

To help you configure a custom belt conveyor easily and conveniently, mk offers the QuickDesigner conveyor technology configurator.



Guarding Configurator

Design custom guarding quickly and easily without a CAD system or prior CAD knowledge.



Deflection Calculator

Convenient tool for calculating the deflection of aluminium profiles as a function of load.



Online Catalogues

Download all current catalogues and flyers in PDF format at no charge.



Social Media

Visit one of our social media channels.

* only for German customers

www.aluprofil.shop



www.quickdesigner.com



www.mk-group.com/en/guarding



www.mk-group.com/en/deflection



Modular Construction Kit for Factory Automation



Profile Technology p. 8

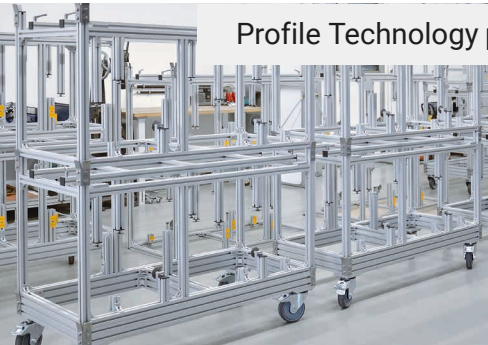

» Components, modules and solutions for factory automation. «

Conveyor Technology p. 18



Our portfolio of profile technology includes workstation set-ups, guarding and custom-designed machine frames and platforms, in addition to the aluminium profile system on which these are based.

mk offer a comprehensive range of standardised conveyor types, complemented by linear technology for precise handling applications.

Furthermore, mk is at hand to assist its customers with system solutions, from project planning and design to the commissioning of complete transfer systems.

System Solutions p. 24



Our services round off the product portfolio and include repairs, maintenance and a spare parts supply service.

To ensure that all products and services are delivered to our customers with the same high quality, our quality management system is certified in accordance with ISO 9001.

Whether custom belt conveyors and assembly workstations to meet the demands of the packaging industry, or pallet systems with guarding to overcome challenges in the automotive industry, or complex profile designs for diverse system construction – our products are established in practically all industries.

Services p. 26



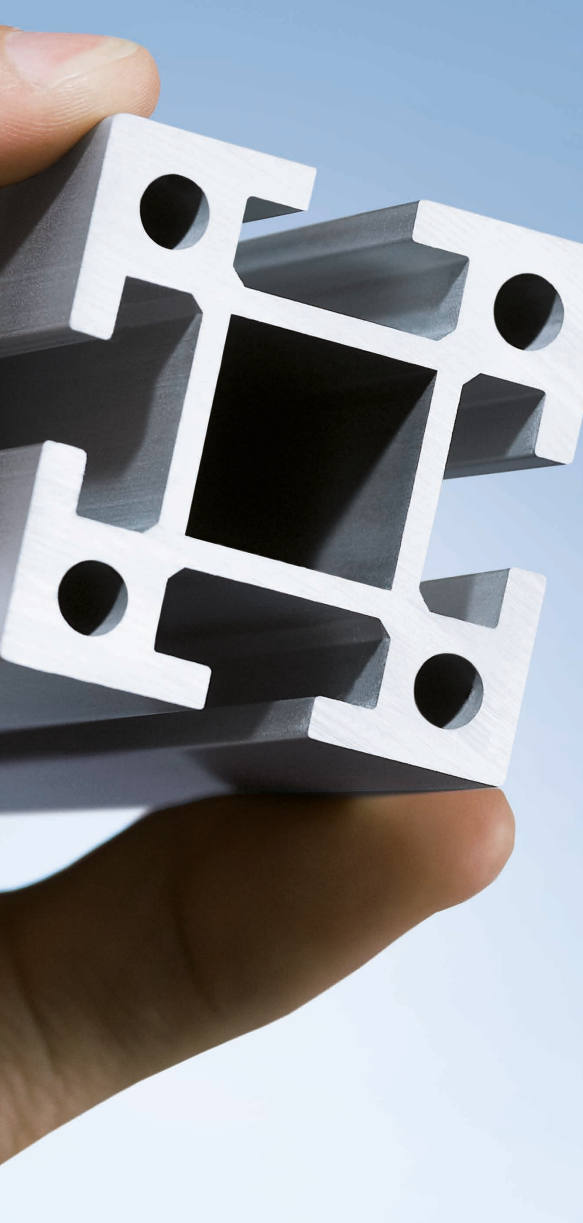

» mk profile technology offers maximum flexibility and reliability. «

Our profile technology consists of the proven, versatile mk profile system as the common base technology as well as the workshop and industrial applications that are based on this system.

Profile System

The modular mk profile system has the right profile, the right connection technology and the right accessories for every application. The system's flexible modular design provides virtually endless possibilities for custom-designed structures and solutions.

Guarding

Our guarding range is based on the mk profile system and offers functional machine housings, enclosures and protective fences. Their flexible, modular design ensures that systems, machines and production areas can be secured effectively and economically.

Workstation Set-Ups

Industrial workstations built from mk's profile system offer maximum ergonomics and functionality to optimise your employees' productivity. These workstations can be expanded into complete assembly lines including workstation inter-linking to ensure optimised process flows.

Machine Frames and Platforms

Frames for machines and other systems are custom-manufactured and optimised for the customer's particular requirements and loads. Platforms with stairs offer safe access to various levels, whether mobile or stationary, to allow employees to maintain or work on machines and systems.

Benefits of mk Profile Technology

- Comprehensive profile system for maximum flexibility in all industries and applications
- No welding, abrasive grinding or painting necessary, unlike steel structures
- Sturdy profiles that combine high load capacity with attractive design
- Profiles and components can be reused
- 1 mm edge radius for virtually gap-free connections between profiles
- Sturdy and diverse connection technology with standard screws
- Machine housings, enclosures and protective fences for effective and highly functional guarding of machines and systems
- Ergonomic industrial workstations built from mk profiles can be interlinked into assembly lines for maximum productivity
- Stairs and platforms for safe access to machines or production areas
- High degree of standardisation for short planning, design and assembly times
- Degree of assembly can be selected, from individual pieces, to assemblies, to custom-built frames and complete applications
- Expert on-site consulting by mk sales engineers

Profile System



Guarding

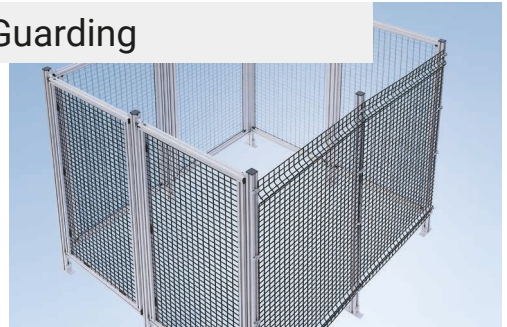

Industrial Workstations



Stairs and Platforms



Profile System

mk Aluminium Profiles









With a large selection of profiles, divided into four series with grid dimensions of 25, 40, 50 and 60 mm, we have the perfect profile for any application and for all load-capacity and design requirements. Our profiles are made from a high-quality aluminium alloy with an extremely durable anodised coating and employ connection technology designed to ensure maximum stability – for sturdiness and dependability that is never in doubt, and without compromising on design. The profile can be used to construct anything from light-duty

fixtures, structures and frames to load-bearing structures for machine construction applications. In addition to construction profiles, our portfolio also includes application profiles for a range of different purposes, e.g. for guarding and workstation set-ups and for conveyor frames and side rails for use in conveyor technology.

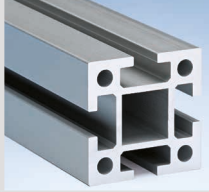
www.aluprofil.shop

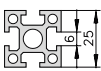
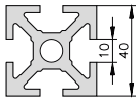
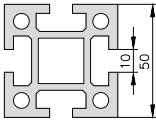
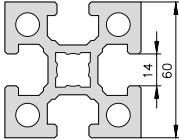

only for German customers

				
	Series 25	Series 40	Series 50	Series 60
Slot width				
Designs	Normal	Normal, light duty, extra light duty	Normal, light duty	Normal
Material	EN AW-6063 T66	EN AW-6063 T66	EN AW-6005A T6	EN AW-6005A T6
Applications	Light-duty frames, showcases, cabinets, test set-ups, measurement and test units, electronics housings	Light-duty machine frames, guarding, industrial workstations, exhibit construction, work platforms	Machine frames, load-bearing structures	Machine frames with heavy loads, gantries
Grid dimensions	 25 x 25 mm	 40 x 40 mm	 50 x 50 mm	 60 x 60 mm
Maximum dimensions	25 x 150 mm or 50 x 50 mm	160 x 160 mm	50 x 200 mm or 100 x 100 mm	120 x 240 mm
Standard fastening accessories	M5	M8	M8	M12

*may differ in certain cases

mk Connecting Elements and Accessories

The mk profile system offers diverse connection possibilities for all grid dimensions and gives you freedom to create your own design. mk connecting elements guarantee simple and efficient assembly and disassembly, reducing overall assembly time. You can select from a variety of different connectors, each with their own special features and advantages, for example angle fasteners, internal fasteners, plate fasteners, corner blocks, truss blocks and clamped connections. With the mk profile system, you can create connections at any angle. All connecting elements use standard screws. Whatever your requirements, we always have the perfect connection technology.

mk accessory components can be optimally integrated into the profile system and consist of numerous reusable components. Our high-quality accessories ensure a high load capacity and long life span and include end caps, locking and cover profiles, wear strips, levelling feet, support brackets, floor fastening, fixed and swivel casters, cover profiles, hinges, operating elements such as handles, pneumatic and electrical accessories, and more. Profile designs can be finished and custom configured per customer instruction.

Angle Fasteners



Internal Fasteners

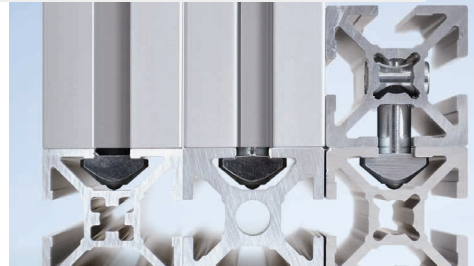

Covers/Wear Strips



Accessory Components



Guarding

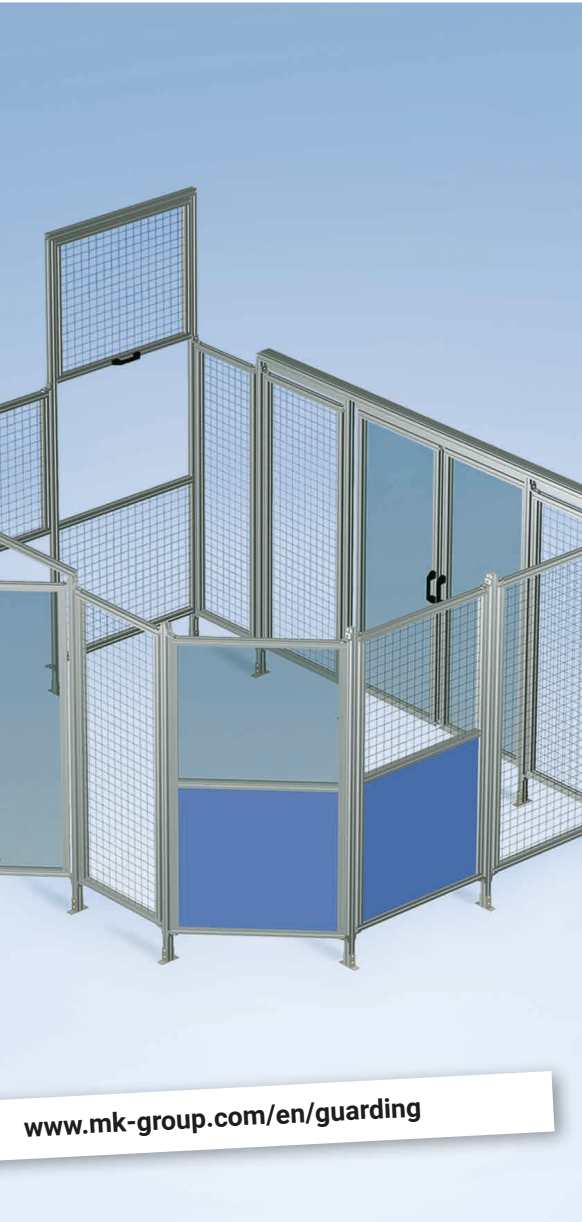

» Machine housings and protective fences for increased occupational safety. «

Our guarding range is based on the mk profile system and offers functional machine housings, enclosures and protective fences. Their flexible, modular design ensures that systems, machines and production areas can be secured effectively and economically.

Choose from a wide range of machine housings, protective fences, panelling, doors and windows, all of which can be electronically secured if desired. It is also easy to connect pneumatically, hydraulically or electrically operated door elements to your machine control system. All guarding is designed and manufactured in accordance with the safety standards applicable in your country. You can be sure that you and your employees are always on the safe side.

Use the guarding configurator to quickly and easily design your own custom guarding. You don't need a CAD system or any knowledge of CAD.

www.mk-group.com/en/guarding

Benefits of mk Guarding

- Modular guarding based on our aluminium profile system
- Attractive design that is also extremely stable and functional
- Screw connections provide the flexibility to expand and make changes
- Degree of assembly can be selected, from individual pieces to finished housings
- Reliable occupational safety in accordance with the Machinery Directive
- 3D product configurator to design your guarding quickly and easily
- Large selection of panelling materials and door variants
- Variable angle fastener up to 135°
- Expert on-site consulting by mk sales engineers

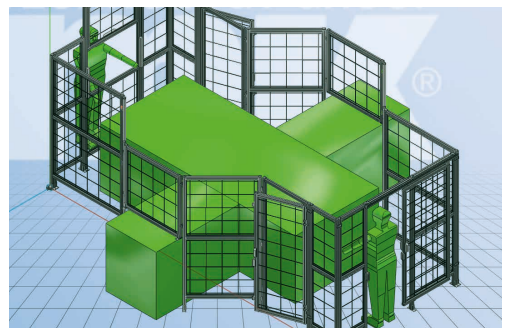

Industrial Workstations



» Industrial workstations for optimal productivity. «

Ergonomically designed industrial workstations not only improve productivity and reduce the rate of mistakes, but they also improve employee's health and well-being. mk workstations can be quickly and easily adjusted to each employee's particular physical needs.

This includes a height adjustment mechanism and a design that allows the workpiece, the tools and the bins for providing materials to be optimally positioned within the employee's reach for the particular task. This helps employees avoid unhealthy postures and optimises productivity.

Providing optimal lighting for the particular task is another critical factor that mk has incorporated with its variable lighting system.

Benefits of mk Industrial Workstations

- Ergonomic and highly functional industrial workstations for optimal productivity
- Aluminium profile construction for ultimate flexibility to expand and make changes
- Table frame with an adjustable height and variable material provision systems allow the workstation to be adapted to the employee
- Extensively customisable, with risers, shelving systems, electrical and pneumatic supply options, tool hangers and drawer cabinets
- mk's extensive experience in expanding these stations into complete assembly lines, including workstation interlinking
- Custom solutions to fit existing processes, including requirements relating to lean production, kanban, ESD or cleanroom processes



Stairs and Platforms



» Platforms, access points and work platforms for safe working. «

With our platforms, we offer custom solutions for safely accessing work areas and performing work on vehicles, machines and systems. The platforms we offer include custom assembly and maintenance platforms, simple standard work platforms, and footbridges for use in production areas.

mk platforms are planned and manufactured to order. We take into account the specific conditions on site, such as large heights or the need for extended reach. Appropriate functions are then planned, such as height adjustment, mobile capabilities or integrated rotary joints. By utilising the mk profile system, we can fulfil virtually any requirement in terms of effective area, travel distance or minimum clearance, depending on the specific application.

The size of the platforms can vary from simple footbridges to assembly platforms that are 15 m long and 6 m high. Foamed combined profiles can be used to construct free-standing bridges of up 8 m.

Benefits of mk Stairs and Platforms

- A variety of designs and options that fulfil safety requirements and improve workstation ergonomics
- Modular design allows for easy assembly and disassembly using standard tools
- Large selection of configurations provided by the profile system gives us maximum flexibility to implement customer-specific functions
- High material quality, sturdy connection technology and high-quality accessories ensure high load capacities and long service lives
- Compatible modules and removable connection technology allow for easy modifications and additions
- High-quality aluminium profiles for an attractive design
- Mobile designs available with fixed or swivel casters or air cushions

Ergonomics



Safety



Flexibility



Conveyor technology



» Function modules for conveying and handling. «

mk conveyor technology modules can meet virtually any requirement for the transport and handling of piece goods. You can select from a range of multi-industry, standardised and modular conveyor systems, which can also be customised if required. These can be combined with rotary tables for buffering product and linear technology modules for precise, dynamic handling tasks.

Conveyor Systems

mk offers the right conveyor system for virtually any transported products and operating conditions. Simply enter your specific parameters into the product filter on our website to display the suitable system.

Rotary Tables

Rotary tables are ideal for maintaining continuous material flows. Workpieces can be buffered, stored, staggered or separated between work steps.

Linear Technology

mk linear technology is the name given to our portfolio of gliding assemblies, track roller assemblies and recirculating ball bearing guides that provide highly precise and reliable linear motion and that are designed to meet your specific requirements.

Accessories

To round out our conveyor technology, mk offers a wide selection of drives, different stand variants, various side rails, standardised and customised pallets, initiators, stoppers, control components, and much more.

www.quickdesigner.com

Conveyor Systems



Rotary Tables



Linear Technology



Accessories



Benefits of mk Conveyor Technology

- A large selection of standardised, modular conveyor systems for optimal function with any transported product and in any environment
- Maximum process reliability thanks to sophisticated technology, high-quality materials and purchased parts, and fast delivery of spare parts worldwide
- Built from standard modules to achieve cost savings and short delivery times
- Expertise in designing and constructing custom conveyors outside our standard product range
- Flexibility ensured by compatibility with all mk construction kit components and modules
- mk sales engineers provide expert advice and assistance in designing your system
- mk QuickDesigner online configurator with CAD model and quotation

Conveyor Types

Belt Conveyors



- For transporting piece goods without specific requirements regarding the product's position and orientation
- Closed belt surface for products with any product geometry
- Choose from a continuous range of different widths and lengths
- Belt runs quietly and with low wear, even at high speeds
- Large selection of belts for various products and applications, e.g. with product accumulation, suitable for food contact, antistatic, etc.
- Custom arrangement of transverse cleats and side walls

Widths [mm]	Lengths [mm]	Total load [kg]	Speed [m/min]	Double-line	Incline	Curves
50-2000	300-20000	up to 200 as standard	up to 80	yes	yes	yes

Modular Belt Conveyors

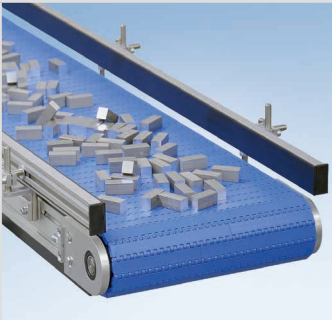

- For transporting piece goods without specific requirements regarding the product's position, orientation or the product geometry
- Positive drive mechanism eliminates slippage and makes it suitable for wet applications; permeable chains also available
- Various robust chain materials to accommodate high temperatures, contact with chemicals or food
- Stable chain travel regardless of the length/width ratio
- Products can be moved diagonally
- Chain can be opened for easy disassembly allowing individual chain modules to be replaced and combined.

Widths [mm]	Lengths [mm]	Total load [kg]	Speed [m/min]	Double-line	Incline	Curves
200-1000	400-10000	up to 250 as standard	up to 30	—	yes	yes

Timing Belt Conveyors



- Ideal for the cycled transport of pallets or product with a rigid structure
- Precise positioning via positive drive mechanism
- Selection of various timing belts with surface coatings customised for the specific application
- High speeds and accelerations possible with quiet and smooth operation
- Suitable pallets, lift-and-transfer modules, stoppers, positioning units, rotating units and control components available

Widths [mm]	Lengths [mm]	Total load [kg]	Speed [m/min]	Double-line	Incline	Curves
40-2000	500-6000	up to 250 as standard	up to 60	yes	—	—

Chain Conveyors

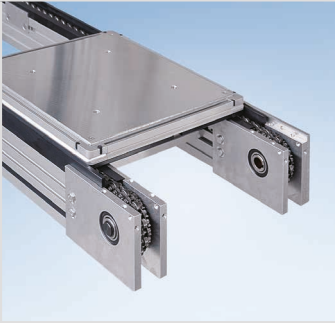

- Ideal as a dual or multiple line system for transporting pallets with heavy loads, including in accumulated operation
- Various chains and wear strips provide optimal support for the workpiece or pallet
- Suitable for dirty and oily environments
- Robust and temperature resistant
- Suitable pallets, lift-and-transfer modules, stoppers, positioning units, rotating units and control components available

Widths [mm]	Lengths [mm]	Total load [kg]	Speed [m/min]	Double-line	Incline	Curves
200-2000	500-10000	up to 1000 as standard	up to 30	yes	–	–

Flat Top Chain Conveyors



- Typically used for transporting bottles, cans or small containers in feeding and interlinking applications
- Complex, three-dimensional track layouts can be constructed with a single conveyor, eliminating joints and transitions
- Positive drive mechanism eliminates slippage and makes it suitable for wet applications
- Various chains (including stainless steel) are available depending on the application, e.g. use in the food industry, etc.
- Suitable for position-based transport using pallets

Widths [mm]	Lengths [mm]	Total load [kg]	Speed [m/min]	Double-line	Incline	Curves
45-300	600-30000	up to 200 as standard	Up to 60	Yes	Yes	Yes

Roller Conveyors



- Rollers mounted on ball bearings for high loads with low drive power
- For transporting piece goods such as solid boxes or pallets with rigid, flat bases
- Various drive concepts (gravity, tangential chains, drive rollers) available for different applications
- Friction rollers allow for accumulated operation
- You can employ segmentation to implement different speeds or start/stop functions in a single conveying path
- Sturdy, affordable and easy to extend

Widths [mm]	Lengths [mm]	Total load [kg]	Speed [m/min]	Double-line	Incline	Curves
150-1050	200-10000	up to 400 as standard	up to 70	–	–	yes

Linear Technology



» Reliable and precise linear motion. «

mk linear technology is the name given to our portfolio of gliding assemblies, track roller assemblies and recirculating ball bearing guides that provide highly precise and reliable linear motion and that are designed to meet your specific requirements.

Whether you need manual adjusting units or driven linear modules with a timing belt for handling applications, we're happy to advise you on how the optimal linear guides can achieve both exact directional movement and low-friction transport.

mk's linear technology components are fully compatible with mk profile technology. Installing linear guides allows you to quickly and easily implement linear movements into your machine frames. This method reduces the materials required for the solution, since a separate support structure for the linear motion is not required.

Gliding Assemblies

- Large contact surfaces for high static load capacity
- Virtually maintenance free
- Good dry-running characteristics
- Good damping
- Compact design

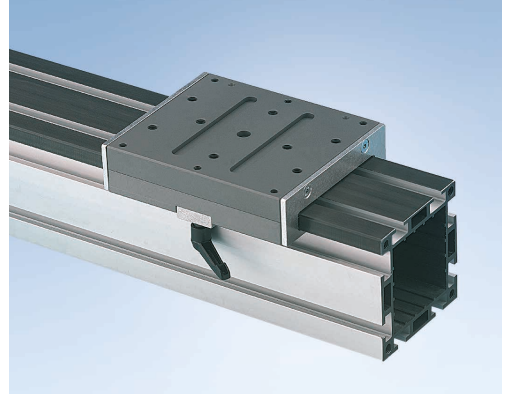

Track Roller Assemblies

- Suitable for high accelerations (up to $a=50 \text{ m/s}^2$) and high travel speeds (up to $v=10 \text{ m/s}$)
- mk clamping profile ensures precise travel for maximum parallelism of the guide rods
- Well suited for harsh environmental conditions (dust, chips, etc.)
- Compensates for large alignment errors
- Bears loads in all directions (forces and torques)
- Simple and economical guide design makes it the more cost-effective solutions for high lengths

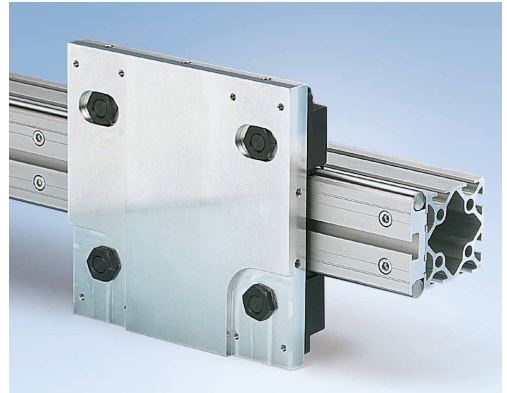

Recirculating Ball Bearing Guides

- High load capacity and high stiffness
- Four-row recirculating ball bearing guide bears loads in all directions (forces and torques)
- Compact design
- High precision with appropriate contact surfaces
- Moderate to high acceleration (up to $a=30 \text{ m/s}^2$) and speeds (up to $v=5 \text{ m/s}$)



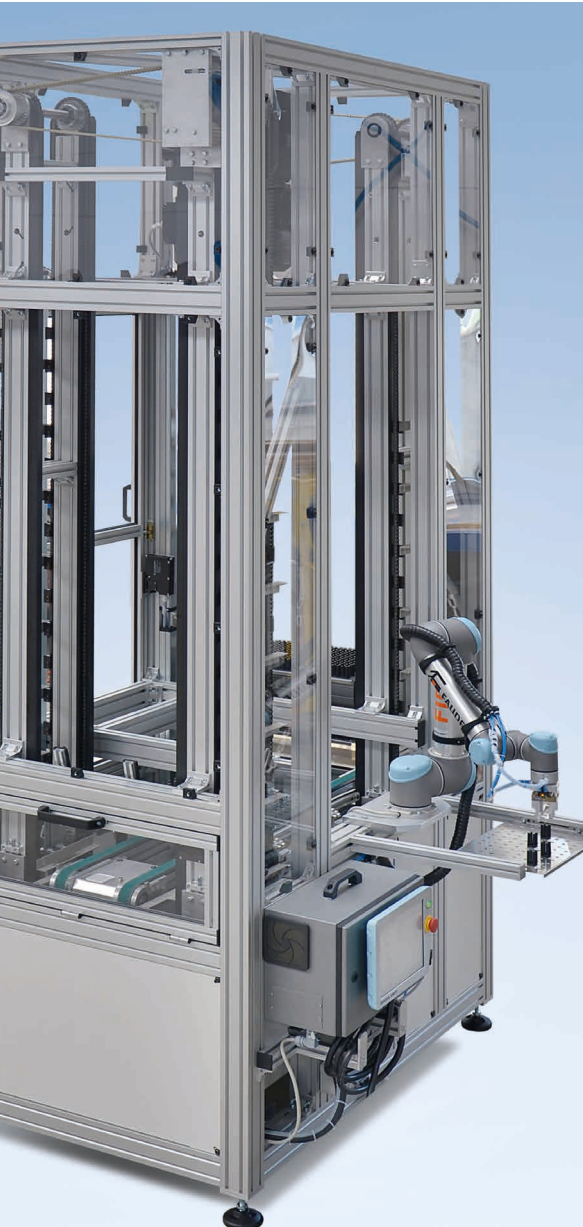

» System solutions for transferring, interlinking and handling. «

Our transfer and handling systems provide you with reliable and practical system solutions. Designed according to your needs, we optimise your manufacturing and assembly processes.

Standardised transfer systems

Versamove is a transfer system for transporting pallets that can be optimally tailored to the customer's specific requirements. Divided into three weight and size classes, it always has the right system for any application. With its modular construction and compatibility with other systems on the market, it can be used for a broad range of applications.

The **SPU 2040** accumulating pallet recirculation system with automatic pallet return is suitable for cost-effective interlinking, feeding, buffering, positioning and separation of workpieces in the tightest of spaces. Pallets are transported from above and then conveyed back suspended below the transport level once the workpieces have been removed.

The robust **TKU 2040** chain conveyor system with optional adjustable width for various workpieces is especially well suited for cycled, defined and position-oriented supply and removal as well as for interlinking machines and machining centres.

Handling systems

Our handling systems are built from our linear technology components as standard, for example multi-axis gantry systems with linear modules and custom grippers. They can be used as pick-and-place units in combination with transfer systems, or they can be used as a standalone solution.

versa *move*

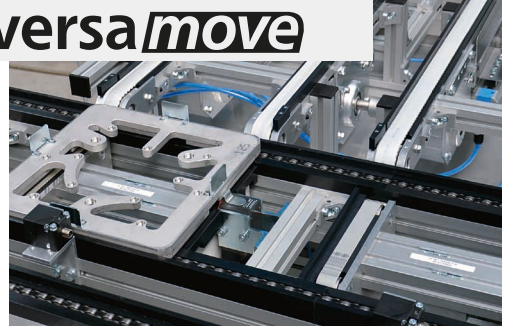

Benefits of mk System Solutions

- Efficient solutions for conveying, feeding, interlinking, sorting, buffering, separating, rotating, loading and unloading
- Based on our proven construction kit of profile, conveyor and linear technology
- Planning, design, assembly and start-up of turnkey systems
- Maintenance and service agreements with choice of various response times
- Locations worldwide for local support
- Guaranteed supply of spare parts from reputable international suppliers
- Extensive industry references in the automotive, electrical, food, pharmaceutical, home appliance, machine tool, packaging and plastics industries

SPU 2040



TKU 2040



Handling System



Services



» Dependable consulting and technical support throughout the entire life cycle. «

Productivity is the key to your company's success in a globally competitive market. Your machines and systems must run continuously and dependably throughout the entire life cycle if you want to be able to fulfil your customer's requirements quickly, efficiently and ensure the utmost quality at all times. We offer comprehensive services to assist you at every stage of your project.

Based on your specific application, the mk field team provides on-site consulting and helps with planning, designing and implementation. Our qualified fitters are available to perform commissioning on site to ensure that production begins quickly and smoothly.

We aim to maintain uninterrupted system availability during service activities. Whether maintenance, servicing or spare parts supply, unforeseen interruptions are kept to a minimum. Remote diagnostics systems simplify and accelerate maintenance, eliminating downtimes and unnecessary costs. We offer customised maintenance agreements for various customer requirements depending on whether you use single components and modules in your machine or complete systems in your production line.

Benefits of mk Service

Pre-sales

- Define and select the right components and modules
- Pretesting at the quotation phase
- Failure mode and effects analysis (FMEA)
- Life cycle and cost (LCC) analysis

Commissioning

- Installation and commissioning
- Functional inspection
- Customer-specific acceptance
- On-site instruction and training

Maintenance and spare parts supply service

- Scalable availability, from 8x5 to 24x7
- Competent on-site technicians
- Use of remote diagnostics systems and preventive maintenance
- Rapid supply of spare parts with high availability





Maschinenbau Kitz GmbH
Headquarters of the
mk Technology Group

Ampèrestrasse 18
53844 Troisdorf, Germany
Germany

Tel. +49 228 4598-0
info@mk-group.com

