

Truss Operating Manual Version 7a

1 Operating Manual for Modular Aluminium Truss Sections designed and manufactured by Total Solutions Group

- 1.1 This document provides the guidelines and recommendations for the use, handling, care and future inspection of the truss for the benefit of the user. Some general matters of safety are also discussed, but these should not be considered as an exhaustive list and users shall satisfy themselves that all reasonable steps are taken to ensure the safety of the personnel who are erecting and dismantling the system.
- 1.2 Trusses are normally made from aluminium to be light weight, easily movable, and generally to have an easy and quick method of fixing

2 Version



















Version: 7

Date: 10th December 2018

- 2.1 Other operating Manuals
- 2.1.1 The User shall also read the “Operating Manual for Demountable Aluminium Roof Top Structures” where appropriate. This document is available from Total Solutions Group. Sections of that Operating Manual are similar to sections in this Manual, however they should be read in conjunction with each other.
- 2.1.2 The User shall read and fully understand both this manual and all other relevant Operating Manuals which are available from TSG before attempting set up a structure without a consultant from TSG being present.
- 2.1.3 If Users are unclear about any aspect of the operation, then they shall seek advice from TSG before proceeding.

3 Important

- 3.1 Read Carefully Before Use
- 3.2 Keep for Future Reference
- 3.3 This manual is applicable to all TSG Truss ranges.
- 3.4 See section *24 Product Specific information* for user information regarding specific product types

-  3.5 **Danger:** For intended use only.
-  3.6 **Danger:** Do not apply other manufacturers' instructions to TSG products.
-  3.7 **Danger:** Do not climb Truss
-  3.8 **Danger:** Do not modify Truss
-  3.9 **Danger:** Holes should never be drilled in a truss.
-  3.10 **Warning:** Aluminium and steel conduct electricity
-  3.11 **Warning:** All load tables assume loading on the bottom cords
-  3.12 **Warning:** Do not use in a severe marine environment
-  3.13 **Warning:** Do not store in freezing conditions
-  3.14 **Warning:** This product shall only be used by a competent person.
-  3.15 **Warning:** This product shall not be used by children
-  3.16 **Warning:** Always inspect product prior to use.
-  3.17 **Warning:** Appropriate PPE should be used where necessary
-  3.18 **Warning;** Wear hearing protection when hammering pins
-  3.19 **Warning:** Never undertake repairs or welding to trusses.
- 3.20 **Caution:** Do not consume.
- 3.21 Any of the above items can lead to the following consequences.
 - Invalidation of warranty
 - refusal of support services
 -  • structural failure
 -  • damage to property
 -  • injury or death

4 Users

- This product is to be used only by competent persons.
- This product shall not be used by children

5 Contents

1	Operating Manual for Modular Aluminium Truss Sections designed and manufactured by Total Solutions Group	- 1 -
2	Version	- 1 -
3	Important	- 1 -
4	Users.....	- 2 -
5	Contents	- 3 -
6	Terms and Definitions	- 4 -
7	Principles of Design.....	- 7 -
8	General Notes.....	- 8 -
9	Tools and Equipment	- 10 -
10	Assembly and connection of trusses	- 10 -
11	Discontinuity of bracing ('Mis-noding')	- 12 -
12	Loading.....	- 12 -
13	Lifting Trusses with hoists or winches.....	- 15 -
14	Trusses and People.....	- 16 -
15	Cantilever trusses	- 17 -
16	Curved and Circular trusses.....	- 17 -
17	Identification and Serial Numbers	- 18 -
18	Wind loads	- 19 -
19	Earthing (Equipotential bonding)	- 19 -
20	Inspection and Maintenance.....	- 19 -
21	Transportation, handling and storage.....	- 22 -
22	Spares and Replacement parts	- 23 -
23	Disposal and Recycling.....	- 23 -

24	Product Specific information	- 23 -
25	List of Significant Hazards.....	- 23 -
26	References.....	- 25 -
27	Inspection and Maintenance record	- 25 -

6 Terms and Definitions

Associated structural components

Corner modules, sleeve modules or any accessories designed to be connected to trusses.

Centre Point Load (CPL)

A single load applied at the center of a simple span.

Competent Person

A person who has the necessary knowledge, skill and experience to carry out the task at hand.

Connection

Connectors or connection elements needed to connect modules and associated structural components.

Connection element

Loose parts for assembling truss modules and associated structural components.

Connector

Permanently fixed connection components of truss modules and associated structural components.

Dead load

The self-weight of the modules.

Dynamic load

A structurally significant magnification of design load due to movement.

End Point Load (EPL)

Single load applied at the unsupported end of a cantilever.

Frequent use factor

Reduction factor used when calculating allowable loads.

Hoist Class

Guidance for crane classification for fatigue, as defined in BS EN 1991-3:2006 Annex B.

Imposed Load

The load imposed by fixtures (including cabling) or other equipment carried by or attached to a truss.

Main chord

Longitudinal member of a truss module.

Module

Lattice structure intended to be used on its own or in combination with other modules.

Monotonic

For which the variation is always in the same direction.

Permanent Action

Action that is likely to act throughout a given reference period and for which the variation in magnitude with time is negligible, or for which the variation is always in the same direction (monotonic) until the action attains a certain limit value.

Quarter Point load (QPL)

Three single loads applied to a simple span that divides the span into quarters.

Side adapters

Connection elements that allow the connection of a module to the face of another module without using a corner block.

Simple Span

The distance between the supports in a horizontal truss.

Snug-tight

'A condition achievable by the effort of one person using a spanner without an extension arm' for tightening bolts.

TFL

Total Fabrications Ltd (part of the Total Solutions Group).

Third Point load (TPL)

Two single loads applied to a simple span that divides the span into thirds.

Tower system

Combination of truss-modules and associated structural components, intended to move and hold truss-modules and other loads.

Truss

A series of modules connected together.

TSG

Total Solutions Group.

Uniformly Distributed Load (UDL)

A load evenly applied across a simple span.

Variable Action

Action for which the variation in magnitude with time is neither negligible nor monotonic.

7 Principles of Design

- 7.1 Dependant on its orientation, loading pattern and spacing and number of supports the chords of a truss are in either tension or compression to develop an internal torque or bending moment. The bottom chord is in tension, and the top chord in compression.
- 7.2 The diagonal and vertical members carry the shear force. Individually, they are also in tension and compression, the exact arrangement of forces is depending on the type of truss and again on the direction of bending. In the truss shown above right, the vertical members are in tension, and the diagonals are in compression. *Fig. 1*
- 7.3 Trusses must always be used in accordance with the manufacturers' instructions.
- 7.4 There should be diagonal braces in the same plane as the load being applied to the truss. For a vertical load, the bracing must be in the sides of the truss. If the load was applied to the truss horizontally, the diagonal bracing in the top and bottom faces of the truss. *Fig. 2*
- 7.5 There are trusses made with bracing on three sides. In using these trusses, care must be taken to ensure that for a vertical load, two of the braced faces are in the vertical plane. *Fig. 3*
- 7.6 The truss is designed to transfer load through the connections, so all the connections must be properly made using the components that were designed to do the job. Pins or bolts must never be left out, improvised or substituted. Damage to the ends of chords, connecting plates, or holes in spigots or fork end connectors will prevent the connection from working efficiently and inhibit the load carrying capacity of the truss.
- 7.7 Trusses are generally connected in one of three ways. Sections are bolted together using bolts in tension through plate connections, *Fig. 4*, or the chords are connected by spigot or fork end connections with shear pins, *Fig. 5*, *Fig. 6*. The connections are of vital importance since they must be as strong as the trusses and transfer loads efficiently.
- 7.8 **Important:** Never connect trusses from different manufactures.
- 7.9 **Important:** Never create a span using modules from different product ranges.
- 7.10 The members in a truss have a specific function. Damaging one member can significantly affect the strength of the whole truss.

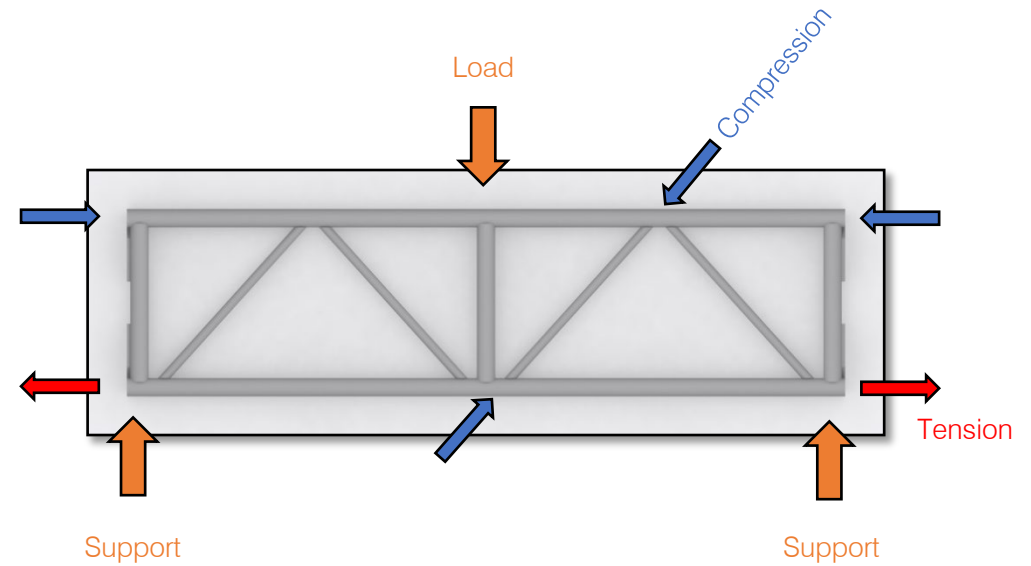

Fig. 1 – Forces (7.2)

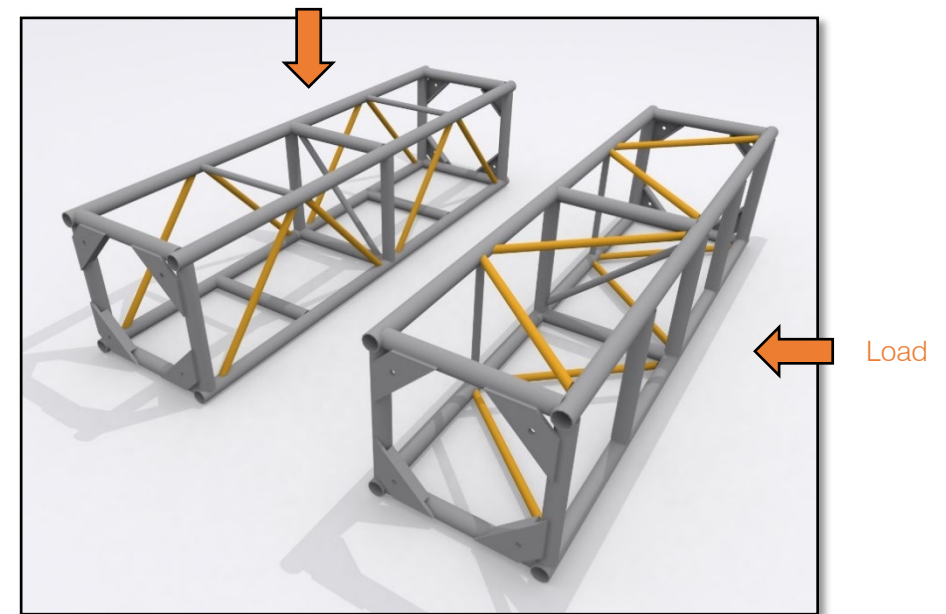

Fig. 2 - Vertical and Side loading brace arrangements (7.4)

- 7.11 Trusses are designed to carry loads at the node points (the points at which members meet). The truss derives its strength from the chords and bracing members being either stretched in tension or squashed axially in compression. Any force that causes a member to deviate from its long axis (centreline) may weaken the overall structure.
- 7.12 Cantilevers can create forces in a truss that may weaken it and guidance should be sought TSG. Loading tables to EN 17115 specify available cantilever load for a given distance.
- 7.13 Application of loads between the node points may lead to local bending of the members which could lead to damage to or failure of the truss. *Fig. 7*
- 7.14 Loading tables to EN 17115 specify allowable loads between node points on a chord but such loads should only be applied after consulting the relevant structural documentation, *Fig. 8*

8 General Notes

- 8.1 The trusses are designed to be used under normal operating conditions and not in extremes of temperature or other particularly adverse conditions.
- 8.2 **Important:** The use of lifting equipment is outside of the scope of this manual. The user should seek advice from the manufacturer as required.
- 8.3 Materials
 - 8.3.1 The material generally used in the manufacture of the truss is 6082 - T6 aluminium alloy.
 - 8.3.2 Surface protection is only needed where the truss is used in severe urban, industrial or marine environments.
- 8.4 Certification, testing and inspection
 - 8.4.1 Persons supplying work equipment are responsible for ensuring that the truss modules are inspected at the appropriate frequency.
 - 8.4.2 The inspection schedule is dependent on such things as frequency of use, typical and maximum imposed loads and this is discussed later. *See Inspection and Maintenance*
 - 8.4.3 Modules must be visually checked by the user for damage before and during assembly.
 - 8.4.4 Modules shall not be used if damaged beyond TSG guidelines. See *Inspection and Maintenance*

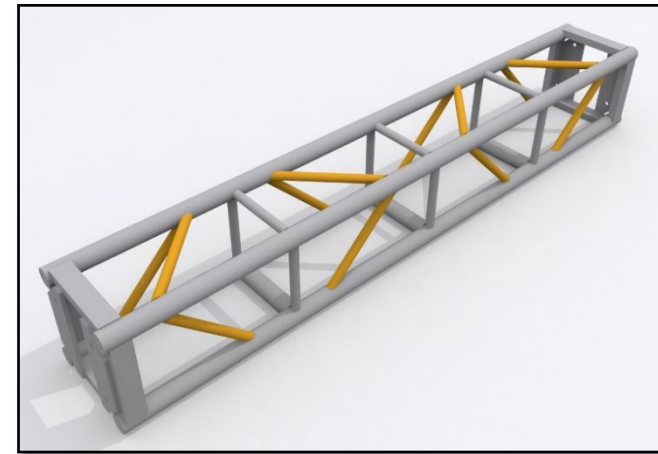

Fig. 3 - Truss with diagonals on three faces (7.5)

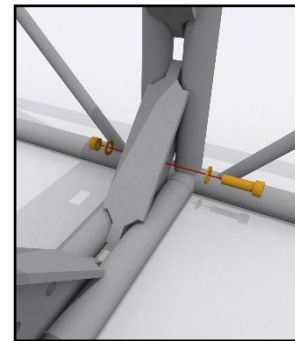

Fig. 4 – Bolt (7.7)

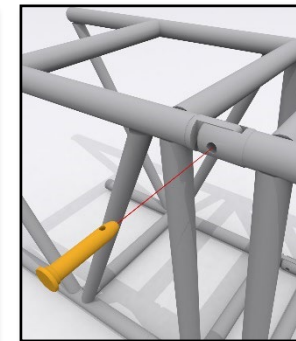

Fig. 5 – Pin (7.7)

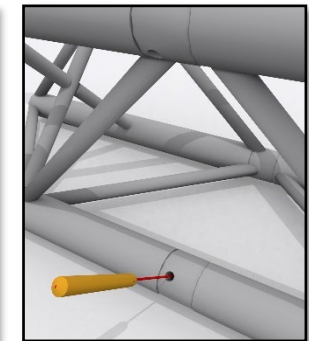

Fig. 6 - Taper Pin (7.7)

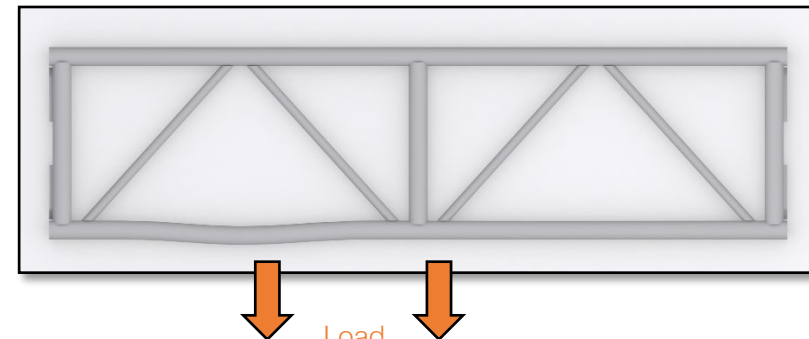



Fig. 7 – Loads (7.13)

8.5 Load Tables, *Fig. 9*

8.5.1 **Caution:** Trusses should be used only in accordance with the load tables relating to that truss type.

8.5.2 Differences in wall thickness, bracing angles, connections and other factors will significantly alter the performance of a truss.

 8.5.3 **Warning:** Using trusses as towers, applying loads other than in the vertical plane and in cantilever can also change the allowable loads shown in tables.

8.5.4 Always consult TSG if the desired application is not explicitly shown in the load tables or other documentation.

8.6 Span

8.6.1 Span between supports is the critical factor in using trusses. The greater the span, the weaker the truss. This is due to both the stiffness of the truss in the vertical plane and in the horizontal plane, *Fig. 8*

8.6.2 If a truss is subject to twisting or lateral movement its capacity to carry loads is affected, *Fig. 10*

8.6.3 Always stay within the quoted spans in load tables.

8.6.4 Load conditions: uniformly distributed loads [UDL], central point load [CPL], third point load [TPL] and quarter point load [QPL]. – *Fig. 16, Fig. 17, Fig. 18 and Fig. 19*

8.6.5 Multiple pickups/supports require the loads to be calculated by a qualified person with reference to the structural report for the truss in question, *Fig. 11*

8.6.6 **Caution:** It should be noted that levelling a truss is no guarantee that the loads are shared evenly between supports.

8.6.7 The only way of accurately monitoring loads on trusses with multiple supports is to use a load cell on each support.

8.7 Supervision of erection, rigging and dismantling of the Structure

 8.7.1 **Warning:** The erection, any modification and the subsequent dismantling of the structure shall be planned and supervised by a competent person

 8.7.2 **Warning:** A competent person shall be responsible for the safe erection or rigging of the structure and check that all components and fasteners are in place and functioning satisfactorily.

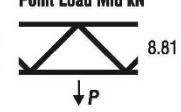
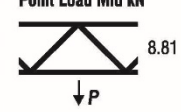
Load Table							Span (metres)		
Span (metres)		3	6	9	12	15	Cantilever Span		
UDL	kg	1774	1223	1028	734	550	UDL	kg	494
	kN	17.40	12.00	10.08	7.20	5.40	UDL	kN	4.50
DEFL	mm	5	18	43	88	136	DEFL	mm	11
							CPL	kg	275
CPL	kg	877	581	514	367	275	DEFL	kN	2.70
	kN	8.60	5.70	5.04	3.60	2.70	DEFL	mm	16
TPL	kg	546	418	385	275	206			
	kN	5.36	4.10	3.78	2.70	2.03			
QPL	kg	428	296	257	183	138			
	kN	4.20	2.90	2.52	1.80	1.35			
DEFL	mm	5	17	45	82	130			

Connection:- Gusset Plate, Fixings: M16 x 45 HT Bolt, Nut & Washers

- All loads are given in Kilograms
- Allowance has been made for self-weight of truss
- Allowance has been made for frequent use factor of 83%
- The payload of the truss has been calculated as a permanent action. Should it be necessary to consider the payload as a variable action, the tabulated figures should be reduced to 90% of the given values

Fig. 9 - Typical Load Table (8.5)

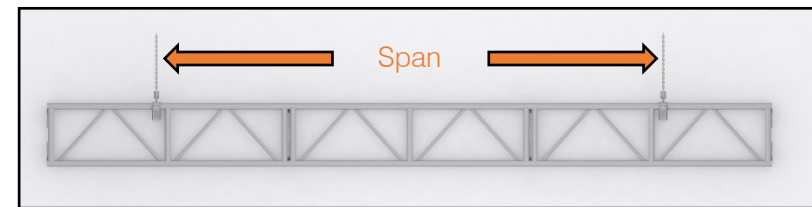

Fig. 8 - Span between supports (8.6.1)

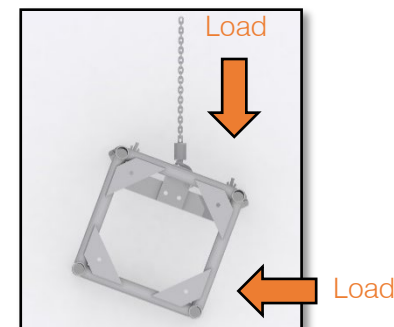

Fig. 10 – Twisting (8.6.2)

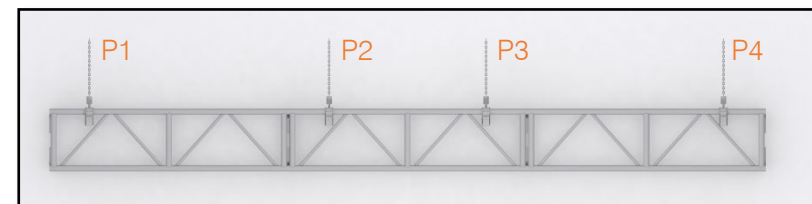



Fig. 11 - Multiple Supports (8.6.5)

 8.7.3 **Warning:** The structure must be checked for damage during and on completion of the erection or dismantling of the structure.

8.8 Existing Structures

 8.8.1 **Warning:** It is the responsibility of the user to check that the existing structures which support the trusses, towers and / or grid are adequate for the purpose.

9 Tools and Equipment

9.1 Pinned connections require

9.1.1 Hammers – ‘soft’ hammers preferred provided they have weight

9.1.2 Drifts / prybars / podgers

9.2 Bolted connections require

9.2.1 Ratchet sets – extended sockets are useful

 9.2.2 **Warning:** Do not extend spanner handles

9.2.3 Ring spanners

9.2.4 Drifts / prybars / podgers

9.3 Additional equipment a user may find useful to provide when assembling modules to form structures could include

9.3.1 baulks of timber,

9.3.2 pallet trucks and

9.3.3 small bottle or scissor jacks to support modules level,

9.3.4 ratchet straps to pull together modules to be connected,

9.3.5 short lengths of tube to act as rollers,

9.3.6 laser levels and plumb bobs.

10 Assembly and connection of trusses

10.1 Nut and Bolt Fixings. *Fig. 12*

10.1.1 All bolts, or other connectors, shall be the size, type and grade shown on the relevant data sheet.

10.1.2 All bolts shall be used with the appropriate washers and nuts.

10.1.3 Use a drift or podger to line up the holes

10.1.4 Nuts only need to be tightened such that the connection is brought to a 'snug-tight' condition. (See definitions)

 10.1.5 **Warning:** Do not over-tighten bolts.

10.1.6 **Important:** No torque is required for the strength of the connection

 10.1.7 **Warning:** Do not use bolts to pull together parts of the structure. Load straps may be used instead. These should be attached at node points on a module.

10.1.8 **Important:** Do not use damaged and / or corroded bolts.

10.2 Fork-end or Spigot fixings. *Fig. 13*

10.2.1 Offer the connection up and where possible, use a drift or podger to gently line up the holes.

10.2.2 Fit one pin and use the podger to line up the opposite hole whilst fitting the other pins.

10.2.3 It is often better to fit pins with the head inside the truss, making it easier to drive the pins out when dismantling the structure.

10.2.4 **Caution:** Using a hammer inside the truss is inefficient and may cause injury.

10.2.5 Use a long-tapered drift to drive pins out, or a pin puller.

10.2.6 **Caution:** Take care to strike the pin and not the connector or truss material.

 10.2.7 **Warning:** Only use the R clips supplied.

 10.2.8 **Warning:** PVC tape is not an appropriate substitute for R clips which prevent the pin from being drawn into the connection under load.

10.3 Taper or Conical pin fixings. *Fig. 14*

10.3.1 **Important:** The pin will only fit from one side.

10.3.2 When one pin is fitted, install the correct R clip to prevent the pin from falling out when the others are being fitted.

10.3.3 **Caution:** Take care to strike the pin and not the connector or truss material.

 10.3.4 **Warning:** Only use the R clips supplied.

 10.3.5 **Warning:** PVC tape is not an appropriate substitute for R clips which prevent the pin from being drawn into the connection under load.

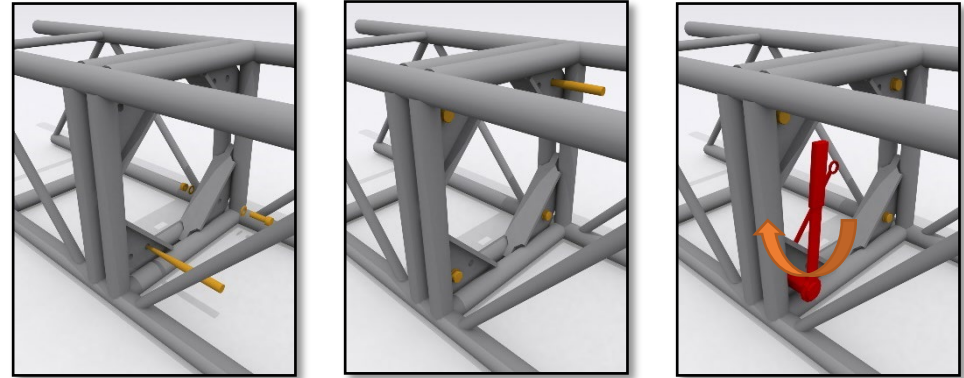

Fig. 12 - Nut & Bolt Fixings (10.1)

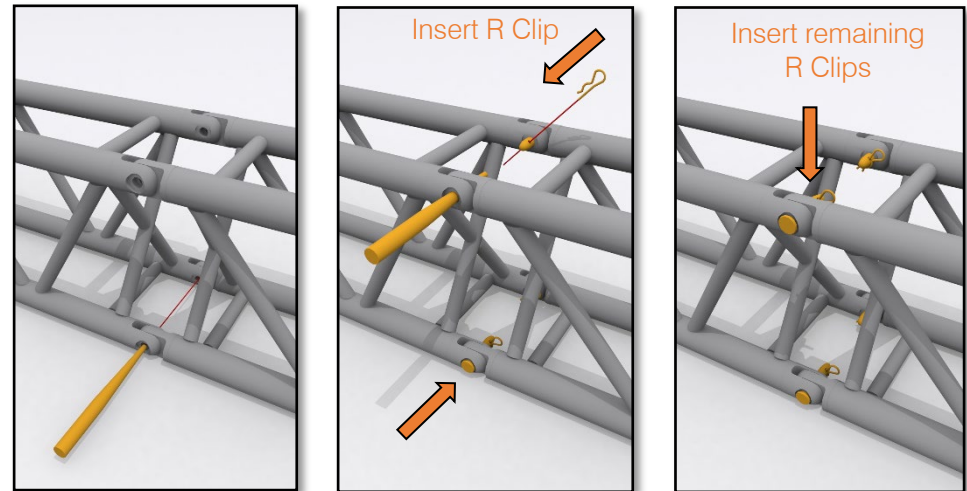

Fig. 13 - Fork-end or Spigot Fixings (10.2)

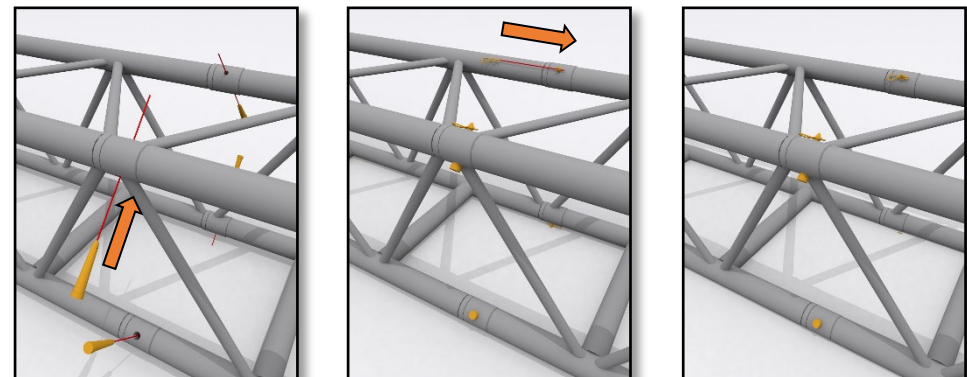



Fig. 14 - Taper or Conical Fixings (10.3)

10.4 On heavier trusses, damage is often caused by poor handling and storage, forcing connections (hammering and bending members by levering, pulling sections together with load straps attached to them and so on), overtightening fixtures and fittings, and over spanning during assembly.

11 Discontinuity of bracing ('Mis-noding')

11.1 Mis-noding of truss can occur when two trusses are joined together, and the continuous bracing pattern is interrupted so the proper transfer of loads through the truss can no longer occur. *Fig. 15*

 11.2 **Warning;** Mis-noding can lead to severe structural consequences and possible collapse of the structure.

11.3 **Important:** Truss designs differ and may be susceptible to mis-noding during construction.

11.4 **Caution:** Check data sheet to ensure truss is oriented correctly.

11.5 Consult TSG for instructions if you are unsure of how to connect modules or connection elements.

12 Loading

12.1 Load Tables

12.1.1 **Caution:** Trusses should be used only in accordance with the load tables relating to that specific truss type.

 12.1.2 **Warning;** Load table data is for vertical imposed loads only. See *Fig. 9*

 12.1.3 **Warning:** All load tables assume loading on the bottom cords. For other loading scenarios seek advice from a competent person.

 12.1.4 **Warning:** Using trusses as towers, applying loads other than in the vertical plane and in a cantilever, will change the allowable loads shown in tables.

12.1.5 Load tables provide the allowable Imposed Load for a given simple span.

12.1.6 Always consult TSG if the desired application is not explicitly shown in the load tables or other documentation.

12.2 Span

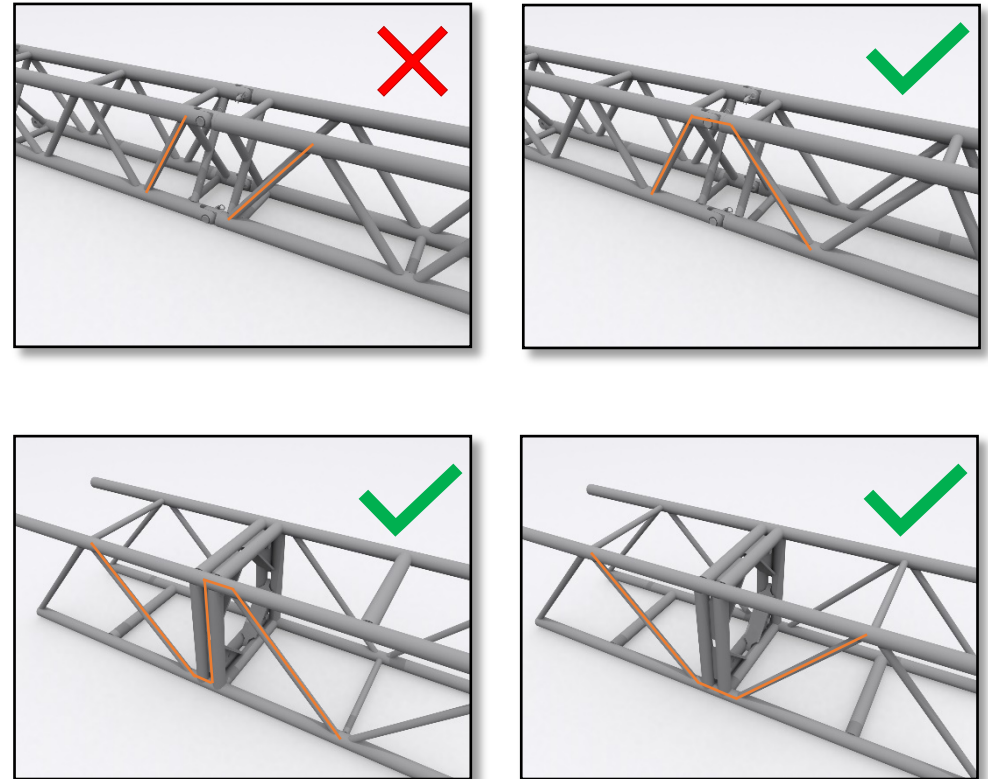

Fig. 15 - Mis-noding or not mis-noding (11.1)

12.2.1 Span between supports is the critical factor in using trusses. The greater the span, the weaker the truss.

12.2.2 Always stay within the quoted spans in load tables.

12.2.3 If a truss is subject to twisting or lateral movement its capacity for imposed loads is affected by the following conditions: uniformly distributed loads [UDL], central point load [CPL], third point load [TPL] and quarter point load [QPL]. *Fig. 16, Fig. 17, Fig. 18 and Fig. 19*

12.2.4 **Caution;** Multiple pickups/supports require the loads to be calculated by a qualified person.

12.2.5 **Caution:** It should be noted that levelling a truss is no guarantee that the loads are shared evenly between supports.

12.2.6 The only way of accurately monitoring loads on trusses with multiple supports is to use a load cell on each support.

12.3 Imposed Loads

 12.3.1 **Warning:** On no account should a truss be used where the allowable load for the intended span has not been defined in the relevant TSG load table.

12.3.2 **Caution:** There are numerous configurations to which the truss could be subjected, and it is not possible to cover every case in the structural calculations.

 12.3.3 **Warning:** Application of loads between the node points may lead to local bending of the members and so should only be applied after consulting the relevant TSG load tables. *Fig. 7*

12.3.4 Loading tables to EN 17115 specify maximum imposed loading on main members between two node points. *Fig. 9*

12.3.5 It is recommended that the user seeks advice from a competent person when considering a truss to be moved during a show or when dynamic loads are to be applied.

12.3.6 Dynamic load is transferred throughout the entire load path from the imposed load and into the supporting structure. *Fig. 20*

12.3.7 No torsion or undue twisting shall be induced in the truss. *Fig. 21*

12.3.8 Distribute Imposed Load across the width of the truss to keep the sides level and vertical, *Fig. 22*. The load tables have been produced assuming that the payload comprises vertical loads only.

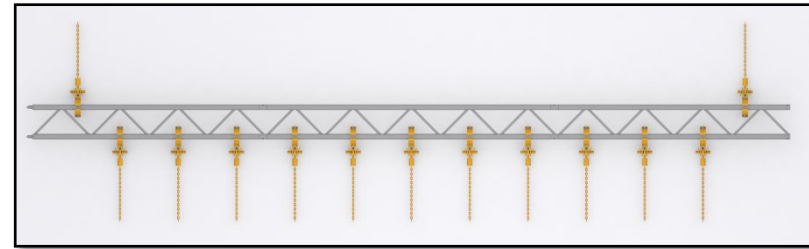

Fig. 16 - Uniform Loading (12.2.3)

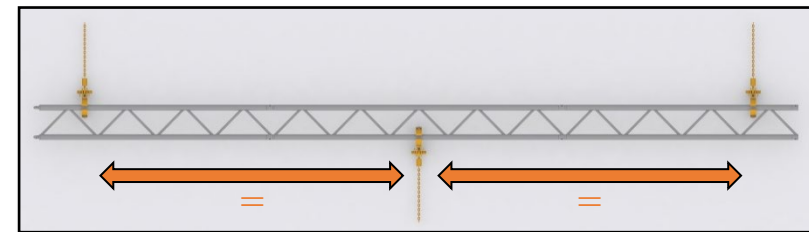

Fig. 17 - Centre Point Loading (12.2.3)

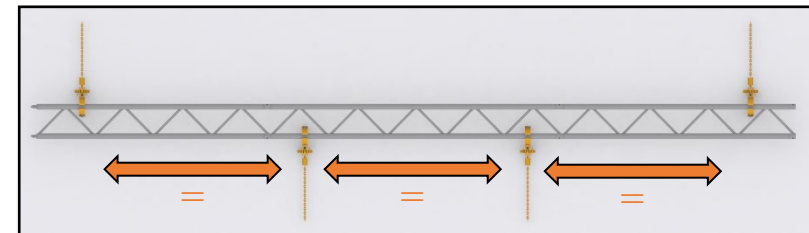

Fig. 18 - Third Point Loading (12.2.3)

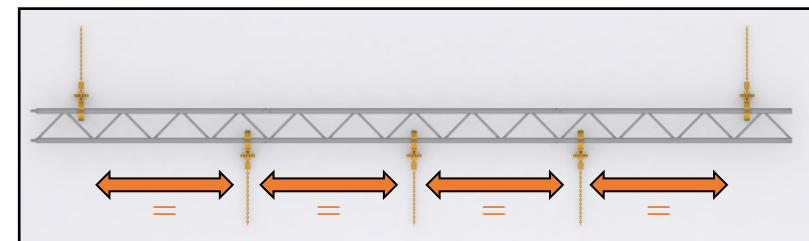

Fig. 19 - Quarter Point Loading (12.2.3)

12.3.9 **Caution:** It should be noted that electrical cable drops can impose a considerable force on the structure particularly if the cables are grouped together.

12.4 Side Adapters

12.4.1 The Imposed Load of the truss which supports the primary truss shall be limited to a factor of 0.43 in the relevant load tables. *Fig. 23*

12.5 Self-weight

12.5.1 TSG load tables take into account the self-weight of the truss modules in a simple span.

12.5.2 **Caution:** TSG Load tables do not include the self-weight of any secondary trusses which may be required to support additional loads. *Fig. 24*

12.5.3 Allowable Imposed Load on a TSG truss is defined in the load tables

12.5.4 The span of truss is established as being the distance between the support points and the allowable load is read from the graphs.

12.5.5 **Important:** For complex load scenarios advice should be sought from a competent person who has adequate experience in the use of structures of this type and they are in any doubt or uncertain about the analysis of an arrangement of loading and the consequent effects on the truss.

12.5.6 If a truss is to be lifted, then account shall be taken by the user of the dynamic loads associated with the speed of lift.

12.5.7 **Caution:** An appropriate dynamic magnification factor to reduce the allowable static Imposed Load shall be defined by the user.

12.6 Frequent Use Factor

12.6.1 If the trusses are to be reconfigured repeatedly, it is best practice to reduce the allowable loads to allow for minor damage to the modules

12.6.2 This reduction factor by which the theoretical loads are normally multiplied is 0.85.

12.6.3 This reduction factor has been used in all TSG structural reports to British Standards and Eurocode

12.6.4 Slick reports to German standards (DIN) do not have this factor applied.



Fig. 20 - Dynamic Load Path (12.3.6)

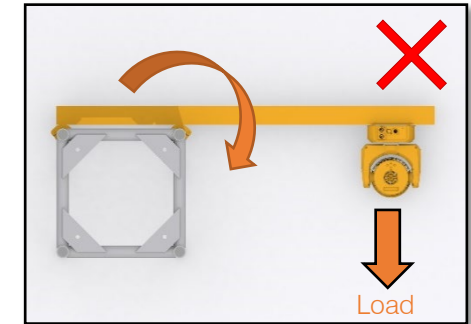

Fig. 21 – No Torsion (12.3.7)

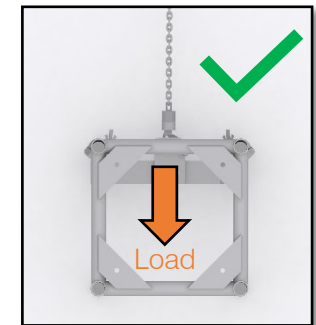

Fig. 22 - Load evenly (12.3.8)

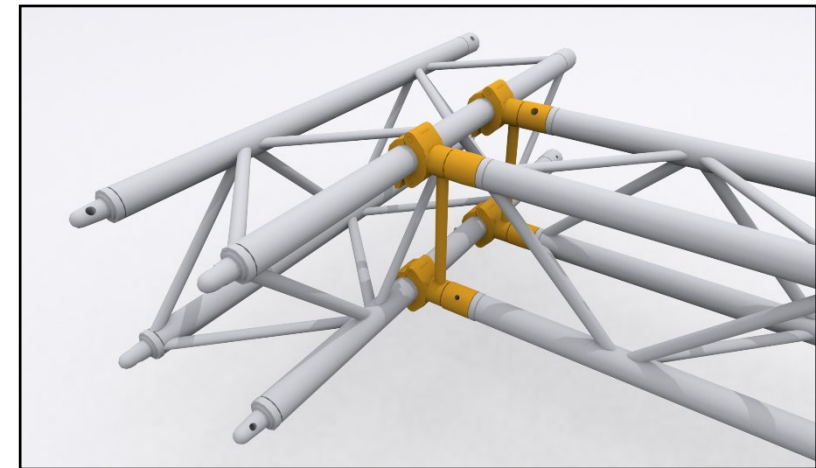



Fig. 23 - 0.43 x Truss Load (12.4.1)

12.6.5 **Important:** If users are in doubt about whether the reduction factor has been used, then they shall contact TSG and seek advice

13 Lifting Trusses with hoists or winches

13.1 Lifting with hoists or winches should only be planned and carried out by a competent person(s)

13.2 If a truss is lifted using chain hoists or similar, then account shall be taken by the user of the “snatch” loads associated with lifting. A dynamic magnification factor shall be used to reduce the allowable static Imposed Load. The value of this dynamic magnification factor shall be defined by the user.

 13.3 **Warning;** load table information does not make any allowance for dynamic forces.

 13.4 **Warning;** Always know the load to be lifted. It is essential to know the value of any imposed loads and how the truss itself is supported.

13.5 Dead load

13.5.1 TSG load tables make an allowance for the self-weight of the truss in a simple span.

13.6 Dynamic loads

13.6.1 Starting or stopping at a speed of 4m per minute produces a ‘snatch’ effect roughly equivalent to a 25% increase in load on the lifting equipment and the supporting structure.

13.6.2 Faster lifting speeds further magnifies the dynamic effect.

13.7 Suspension of trusses; ‘rigging’

13.7.1 Only to be planned and carried out by a competent person(s)

13.7.2 Connection elements used to connect lifting equipment to trusses should be of sufficient capacity to support the calculated load.

13.7.3 On a single truss span suspensions must be fitted to the top chords to prevent overturning. *Fig. 25*

13.7.4 Suspensions should generally be located at node points. *Fig. 26*

13.7.5 For suspension use a TSG purpose designed ‘pick-up beam’ or a round sling or softened wire rope as determined by a competent person.

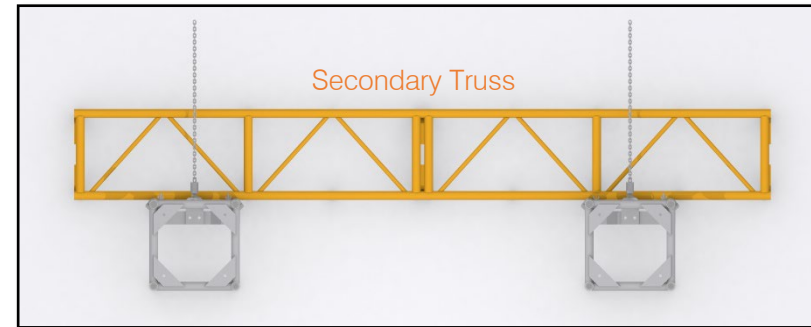

Fig. 24 - Secondary truss self-weight (12.5.2)

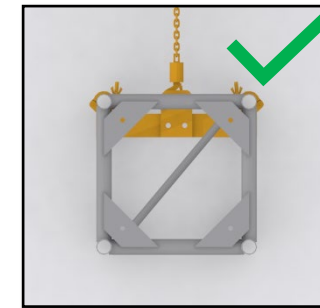

Fig. 25 - Single Span (13.7.3)

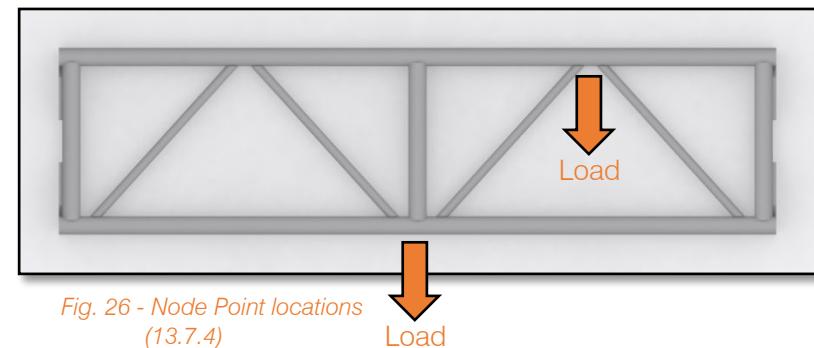

Fig. 26 - Node Point locations (13.7.4)

- 13.7.6 Do not use two connection elements on the same chords in the same bay. *Fig. 27*
- 13.7.7 Connection elements can be fitted to upper or lower chords.
- 13.7.8 Avoid letting slack motors sit on pickup beams, *Fig. 28*, they can cause twisting of the pickup beam and damage the hoist should it slip off.
- 13.7.9 Ensure the suspension applies load to the pick-up beam vertically to avoid it trying to twist the truss. *Fig. 29*
- 13.8 Slings
 - 13.8.1 **Caution:** Slings apply compression to truss chords and should be fitted at a node point that offers resistance to the compression.
 - 13.8.2 The wider the sling angle the greater the compression applied.
 - 13.8.3 **Important;** Polyester round slings spread load over a greater area than a wire rope sling but are weakened by heat and can be pinched or cut by connections between modules.
 - 13.8.4 For Suggested ways to sling trusses see separate [TSG load booklet](#)

14 Trusses and People

- 14.1 **Important:** Data in TSG load tables does not account for supporting personnel.
- 14.2 **Important:** The Work at Height Regulations 2005 place duties on employers to eliminate the need to work at height wherever possible, and where it is necessary to prevent falls from occurring. The hierarchy of control measures to prevent falls starts with platforms and ends with 'climbing' access as a last resort.
- 14.3 Fall Arrest
 - 14.3.1 **Danger:** No account has been taken in TSG design calculations of forces associated with the use of fall arrest equipment.
 - 14.3.2 **Important:** The forces likely to be generated by any fall protection system shall be checked by a competent person before being attached to a TSG module.

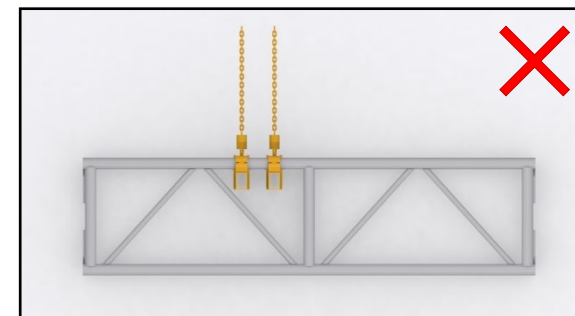

Fig. 27 - Two Connection Elements (13.7.6)

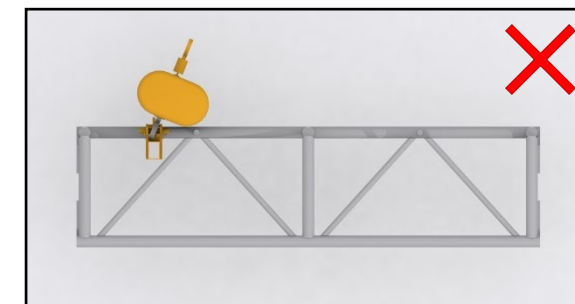

Fig. 28 - Slack Motors (13.7.8)

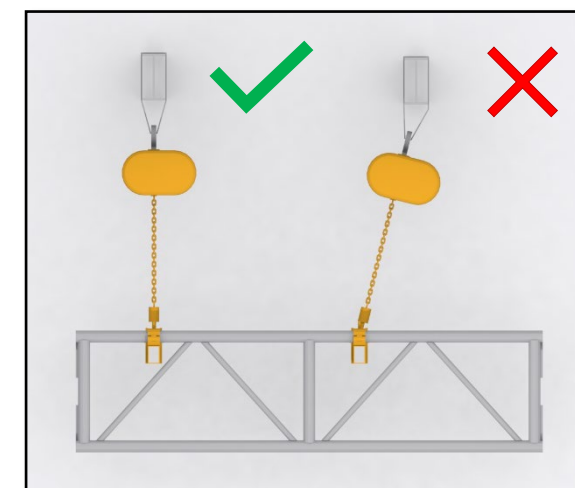



Fig. 29 - Vertical pickups (13.7.9)

14.3.3 The T2 system from the Total Solutions Group offers an exceptionally strong structural system with a fall arrest facility inbuilt by the manufacturer. This provides a safe system of work when supported appropriately from a suitable structure.

15 Cantilever trusses

15.1 Extending a truss beyond a support creates a 'cantilever' which is less stable than a simple span.

 15.2 **Warning:** Application of a point load to a cantilever should never exceed 25% of the CPL of the back-span length, *Fig. 30*

 15.3 **Warning:** Application of a uniform load to a cantilever should never exceed 25% of the UDL of the back-span length, *Fig. 31*

15.4 TSG structural reports conforming to EN17115 will always contain cantilever loading data.

16 Curved and Circular trusses

16.1 **Important:** Circular trusses are not generic products.

 16.2 **Warning:** There is no loading information available without structural analysis.

 16.3 **Warning:** Do not refer to TSG generic truss load tables to determine allowable loads on circular trusses.

16.4 Circular trusses intended to be flown horizontally should not be flown at angles without consulting TSG.

16.5 The arc of a truss between support points is a cantilever. Therefore, allowable loads must be determined prior to use by a competent person. *Fig. 32*, When lifting truss circles aim to support them in as many places as possible.

 16.6 **Warning:** Do not try to lift or support a circular truss on fewer supports than required by the structural analysis

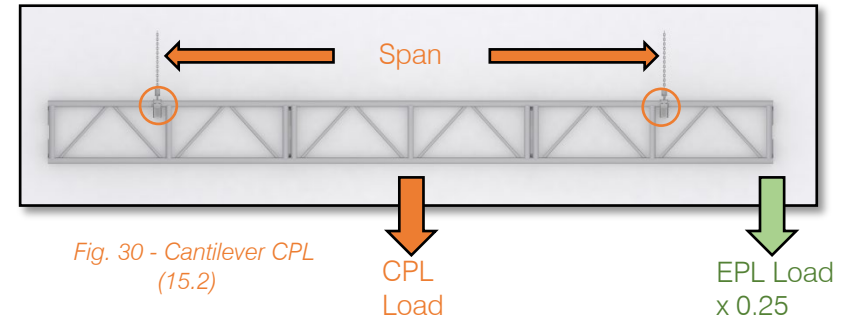

Fig. 30 - Cantilever CPL (15.2)

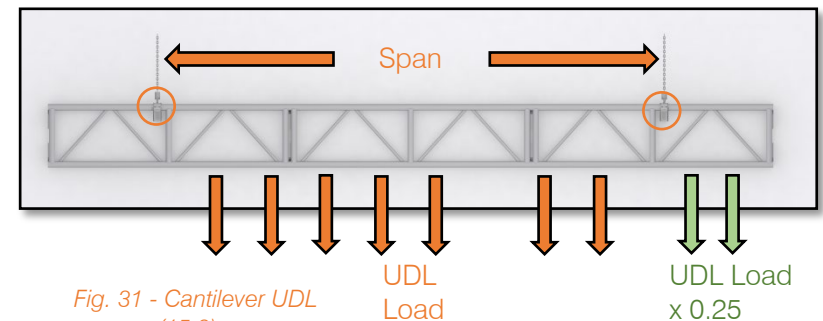

Fig. 31 - Cantilever UDL (15.3)

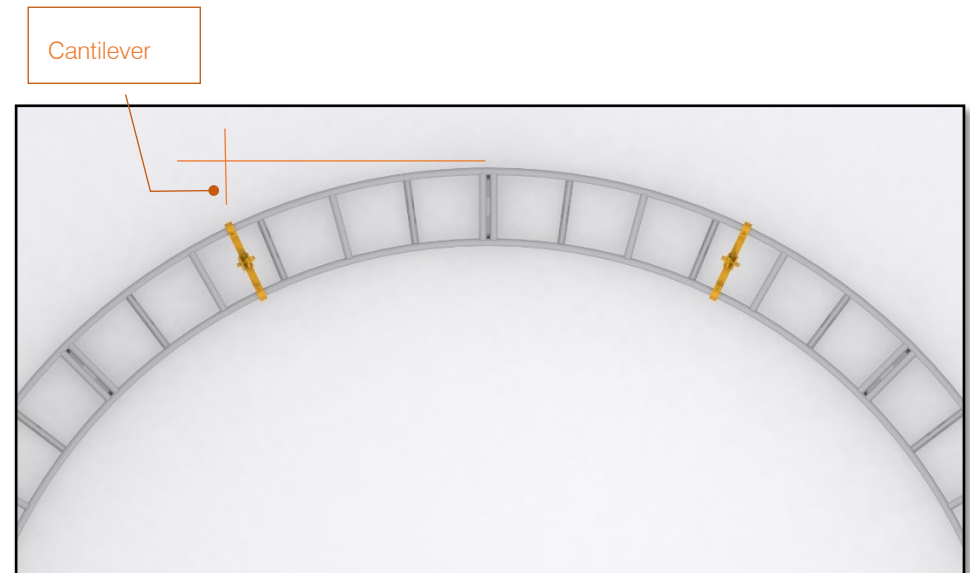

Fig. 32 - Curved Trusses (16.5)

17 Identification and Serial Numbers

- 17.1 Each truss and component have an identification mark unique to TSG.
- 17.2 The label is easily recognisable, durable and should not be obscured or removed.
- 17.3 The label includes the TSG name, type of module or component, month and year of manufacture, self-weight and the unique serial number and barcode. *Fig. 33*
- 17.4 TSG Prefix codes for standard products are listed below: -

OV30	OV 30cm Square Truss	XOS	TFL XO Square
OV30L	OV 30cm Ladder	XOT	TFL XO Tri
OV30T	OV 30cm Tri. Truss	LD12	TFL Light Duty Truss
OV40	OV 40cm Square Truss	SLD	TFL Serious Light Duty
OV40L	OV 40cm Ladder	MD	TFL Medium Duty
OV40T	OV 40cm Tri. Truss	SMD	TFL Serious Medium Duty
LB	Slick Litebeam	HD	TFL Heavy Duty Truss
LX	Slick Litebox	SHD	TFL Serious Heavy Duty
GL	Slick GS Lite	LAD	Moving Light Truss
MB	Slick Minibeam	EHD	TFL Extra Heavy Duty
1G	Slick GS Truss	12GST	TFL 12" Tower Truss
NL	Slick Nova Lite Truss	18GST	TFL 18" Tower Truss
NO	Slick Nova Beam Truss		
M	Slick Maxibeam	LAB	Slick Lite Ladder
5T	Slick Superbeam	SML	Slick Mini Ladder
5TCAT	Slick Superbeam Catwalk	SL	Slick Maxi Ladder
LT	Slick Lite Tower		
1TM	Slick Litemast		

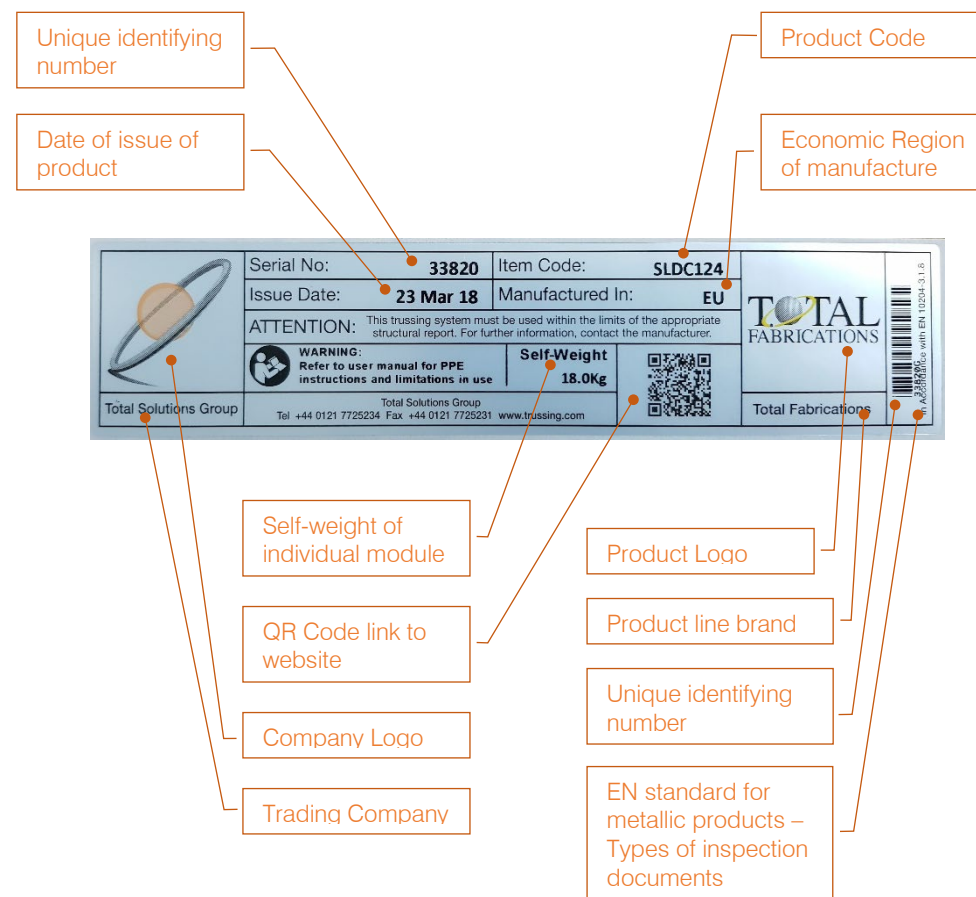

Fig. 33 – TSG Product Identification Label (17.3)

18 Wind loads

- 18.1 **Important:** Stability of structures can be affected indoors and outdoors by changes in wind speed, direction and pressure. *Fig. 34*
- 18.2 Stability calculations must be carried by a competent person
- 18.3 The appropriate structural report will contain instructions that must be followed by the user.
- 18.4 **Important:** Reference should be made to 'Temporary Demountable Structures'

19 Earthing (Equipotential bonding)

- 19.1 Appropriate earth bonding shall be determined by a Competent Person.
- 19.2 The surface of the aluminium or steel shall be cleaned with wire wool to remove the oxidation on the surface before the earth clamps are fitted.
- 19.3 **Caution:** The User should note that there is not a proper connection between the main grid structure and the towers in a ground support structure as the grid is guided up and down the towers with nylon wheels.

20 Inspection and Maintenance

- 20.1 **Important:** These inspection criteria relate only to TSG manufactured trusses.
- 20.2 Discard or Quarantine criteria; General
 - 20.2.1 Bent or deformed without load applied
 - 20.2.2 Welds are incomplete or shows signs of cracking. Certain cracks are associated with the manufacturing process. If in doubt, consult TSG.
 - 20.2.3 Wear on welds and welded areas.
 - 20.2.4 Repairs made without written approval from TSG.
- 20.3 Discard or Quarantine criteria; Main members
 - 20.3.1 Reduction of the total cross-sectional surface area by more than 15%, *Fig. 35*; or any local area reduction transverse to the tube axis of more than 15%, *Fig. 36*.
 - 20.3.2 Localised bending of one or more of the main tubes viewed from the end of a section.

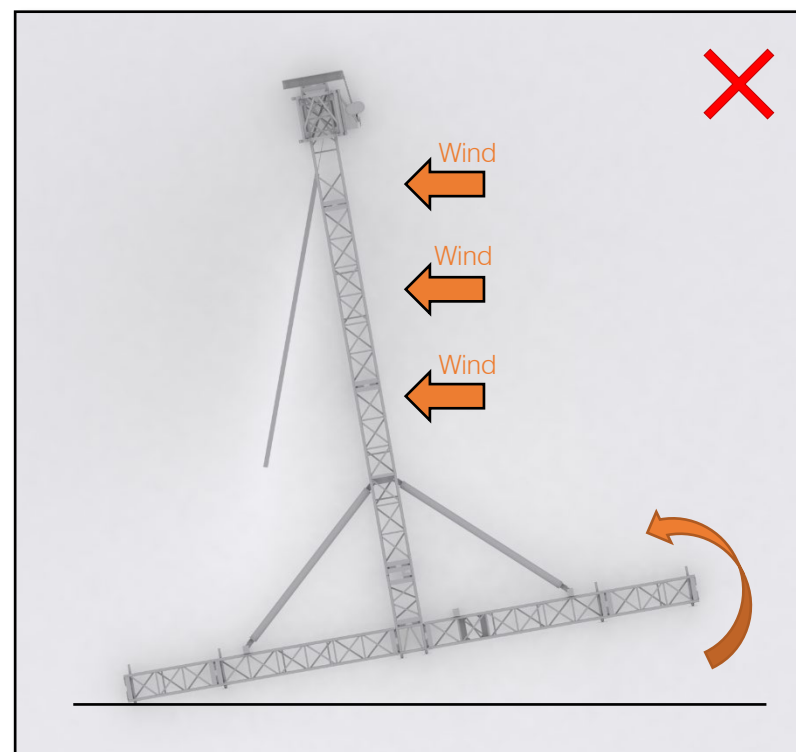

Fig. 34 - Wind Load Stability (18.1)

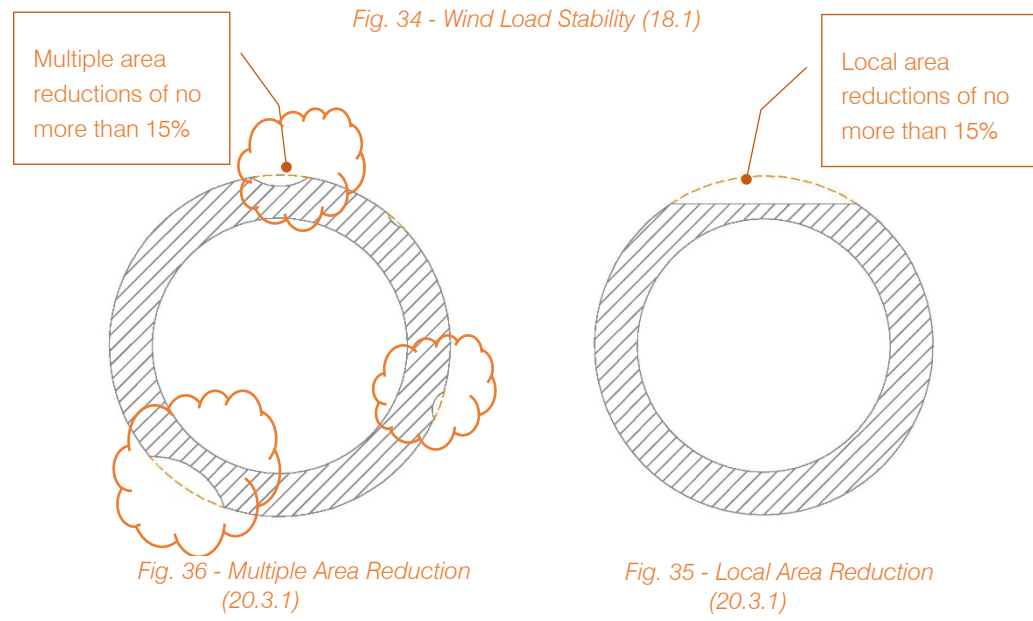

Fig. 36 - Multiple Area Reduction (20.3.1)

Fig. 35 - Local Area Reduction (20.3.1)

- 20.3.3 Damaged, partly missing or broken tubes.
- 20.3.4 Cracks or holes in the main tubes including drilled holes.
- 20.3.5 Holes from the manufacturing process should not be considered as damage
- 20.3.6 Lasting deformation through dents, lateral compression etc. that results in a change of diameter (D) by more than 10%. e.g. Lite Beam tube dia. = 48mm; 44mm minimum and 52mm maximum. *Fig. 37*
- 20.4 Discard or Quarantine criteria; Lattice members
 - 20.4.1 Reduction of the total cross-sectional surface area by more than 15%, *Fig. 35*, or any local area reduction transverse to the tube axis of more than 15%. *Fig. 36*
 - 20.4.2 Localised bending of one or more of the lattice tubes.
 - 20.4.3 Damaged, missing, or broken lattice tubes.
 - 20.4.4 Cracks or holes in the lattice tubes.
 - 20.4.5 Holes from the manufacturing process should not be considered as damage.
 - 20.4.6 Lasting deformation through dents, lateral compression etc. that results in a change of diameter by more than 10%. *Fig. 37*
- 20.5 Discard or Quarantine criteria; Connectors and connecting elements
 - 20.5.1 Deformation or elongation of connection holes (rivets, roll pins, in gusset plates) in the fittings or the main tubes by more than 10% e.g. Lite Beam 6.25mm + 0.63mm = 6.88mm max. Mini Beam, GS Truss, Maxi Beam, Folding Truss 10mm + 1mm = 11mm. Bending or deformation of any fitting part by more than 10 degrees from the axis of the main tubes. *Fig. 38*
 - 20.5.2 Reduction of the cross-sectional area of the connector (male or female) surface by more than 10%. *Fig. 39*
 - 20.5.3 Damaged connector or parts of the connector missing.
 - 20.5.4 Damaged or missing roll pins or fixing rivets.
 - 20.5.5 Fixing rivet should completely fill holes and have close contact with the riveted surfaces
 - 20.5.6 Diameter reduction of connector elements (truss pins or fixing bolt) by more than 10%. *Fig. 40*

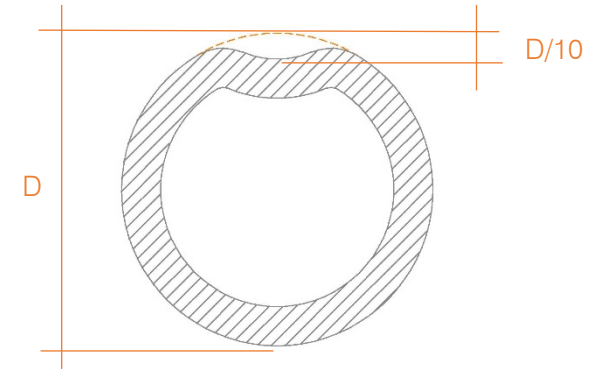

Fig. 37 – Dents (20.3.6)

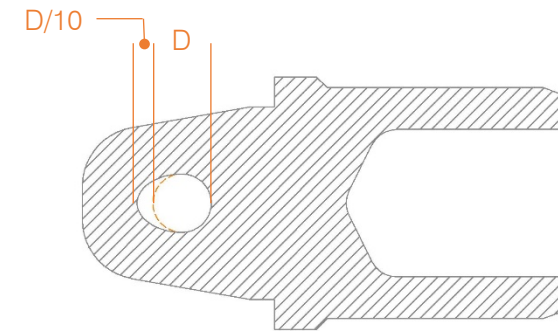

Fig. 38 - Hole Elongation (20.5.1)

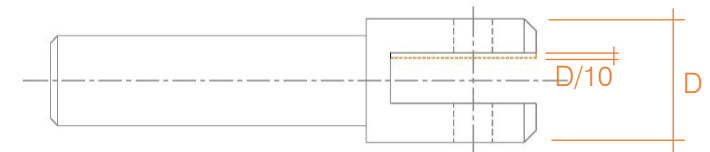

Fig. 39 - Connector Reduction (20.5.2)

- 20.5.7 No damage to the threads on fixing bolts
- 20.5.8 Clear (galvanic) corrosion on rivets or roll pins in the connectors.

20.6 Painting

- 20.6.1 Inspecting painted modules is difficult because paint can obscure surface defects and cracked welds.
- 20.6.2 If a module is painted repeatedly defects may exist indefinitely.
- 20.6.3 Modules should always have previous layers of paint removed before any new painting occurs.
- 20.6.4 Modules should be re-inspected before new paint is applied.
- 20.6.5 Paint removal must not reduce the dimensions of any materials.



- 20.6.6 **Warning:** Chemical treatments damage aluminium. Do not use chemical baths for paint-stripping.

20.7 Saline environment

- 20.7.1 If trusses are subjected to a salty atmosphere, then they should be rinsed on a regular basis.

20.8 Corrosion

- 20.8.1 The contact surfaces of different metals should be checked for corrosion, for example the bolts and their bearing surfaces.

20.9 Attention



- 20.9.1 **Danger:** Neglecting any of the above factors may result in property damage, injury to people or death.
- 20.9.2 **Important:** Damaged modules should be clearly marked as such and shall not be used under any circumstance. Any repair must be undertaken by an authorized agent of TSG.
- 20.9.3 **Important:** If 3rd party inspections are checking welds then they should only inspect TSG products if they are fully conversant with the following:
 - Execution class
 - Consequence class
 - Weld quality level

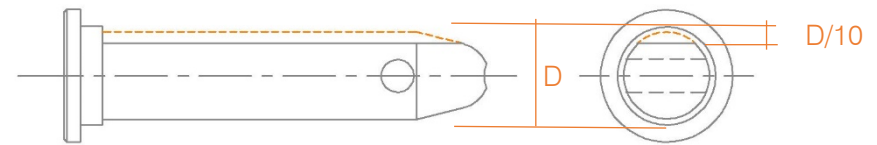



Fig. 40 - Connecting Element Reduction (Pin) (20.5.6)

20.9.4 **Important:** Aluminium Trusses should be inspected by, and in line with an Examination Scheme drawn up by, a competent person based on a Risk Analysis of usage.

21 Transportation, handling and storage

- 21.1 The trusses shall be loaded in such a way that they are not put under undue or significant stress during transportation.
- 21.2 Take care to ensure that modules are not subjected to abrasion which could result in loss of metal or other damage.
- 21.3 Do not allow load restraints to damage modules.
- 21.4 On no account shall trusses be dragged across the floor as this could lead to abrasion of the chords, which would result in loss of metal, or significant cuts, gouges or other damage which could result in stress concentrations and ultimately to stress fracturing.
- 21.5 Take care where fork lifts are used to move modules.
- 21.6 Position the forks to avoid damage to the module, particularly the diagonals. *Fig. 41*
- 21.7 When lifting equipment modules with fork lifts ensure that forks are positioned as close to node points as possible.
- 21.8 Stacks of modules should be supported off the ground at node points.
- 21.9 Take care to ensure stacks of modules remain stable. *Fig. 42*
-  21.10 **Warning:** Modules may be heavy enough to prevent safe manual handling. Mechanical means are preferred.
- 21.11 The trusses shall not be stored outside unless they are adequately protected from the elements.
-  21.12 **Warning:** Do not allow water ingress where there is a possibility of freezing conditions
- 21.13 The user shall use adequate care when storing the trusses so that they are not overstressed. For example, the trusses should not be stacked so that the members or connections are bent or damaged.

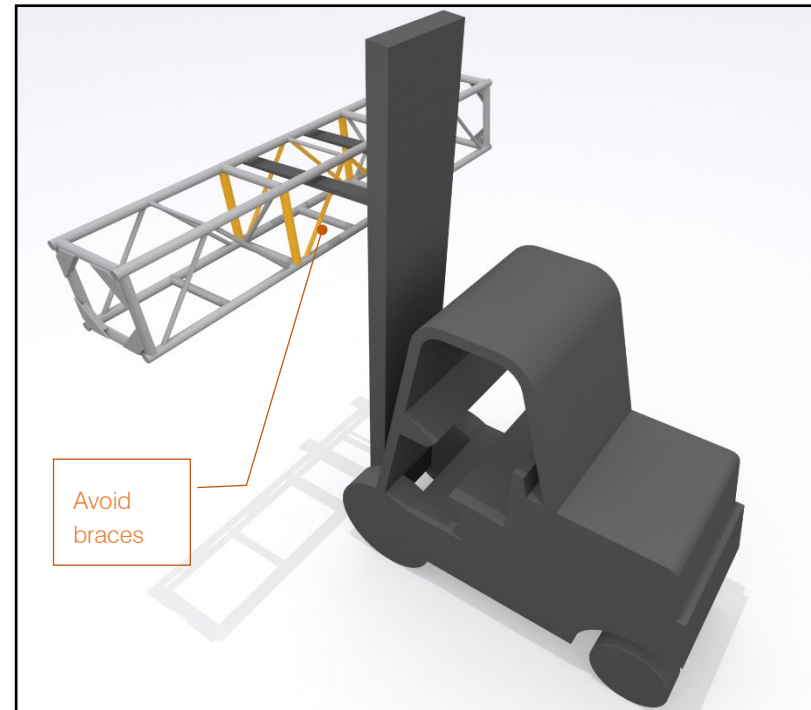

Fig. 41 - Forklift Damage (21.6)

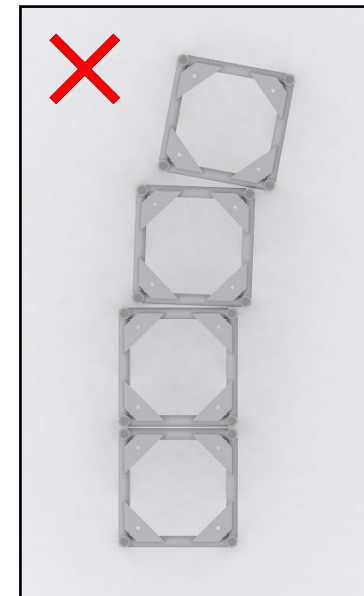



Fig. 42 – Stacking (21.9)

22 Spares and Replacement parts

22.1 There are no parts on a truss module that are replaceable by the user.

23 Disposal and Recycling

 23.1 All items of an aluminium or steel truss, unless otherwise stated, are 100% recyclable.

24 Product Specific information

24.1 Litebeam, Litebox, OV Truss Range

 24.1.1 **Warning;** Do not support or apply load at the very end of a single span. *Fig. 43*

24.2 GS Truss, Minibeam, Maxibeam and Superbeam

 24.2.1 **Warning;** Side diagonal brace patterns must flow. *Fig. 44*

24.3 GS Truss (when used as a tower)

 24.3.1 **Warning;** Hinge point must be on the supported end *Fig. 45*

24.4 Maxibeam Truss

24.4.1 **Caution:** Open bottom versions of Maxibeam must be fitted with the appropriate number of snap braces. Example; a 2.4mt truss should have 2 x snap braces. *Fig. 46*

24.5 Medium Duty Truss

24.5.1 **Important;** trusses pre-2017 have two bolt holes per gusset plate i.e. 8 per face. Only the outer hole on each gusset is used for connections. The inner hole serves no structural purpose. *Fig. 47*

25 List of Significant Hazards

25.1 Mechanical hazards due to:

25.1.1 Inadequate mechanical strength

25.1.2 Instability

25.1.3 Gravity and stability

25.1.4 Height from the ground

25.1.5 Approach of moving elements to fixed parts

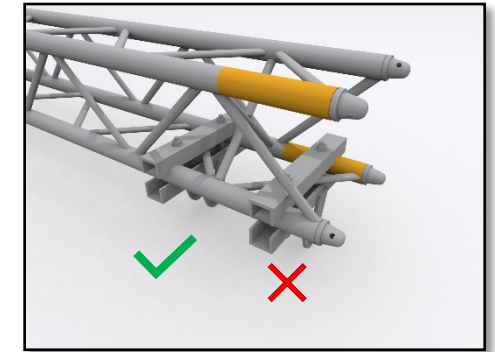
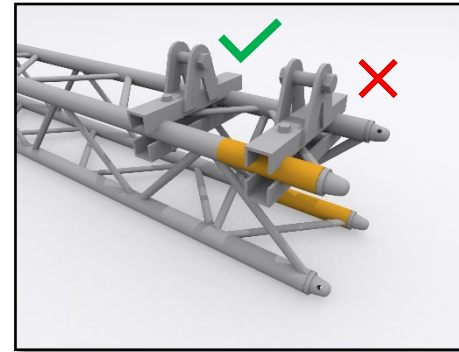

Fig. 43 - Litebeam, Litebox and OV Range (24.1.1)

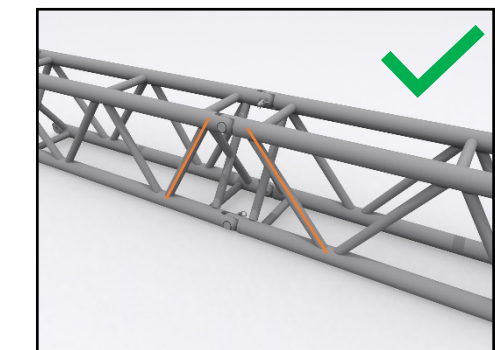
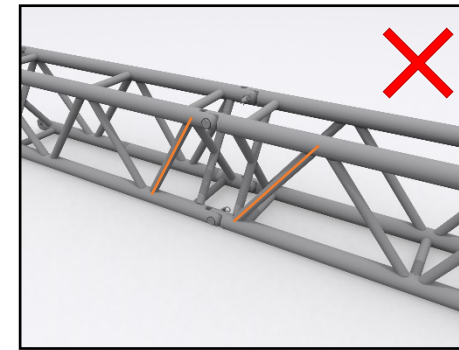

Fig. 44 - GS Truss, Minibeam, Maxibeam and Superbeam (24.2.1)

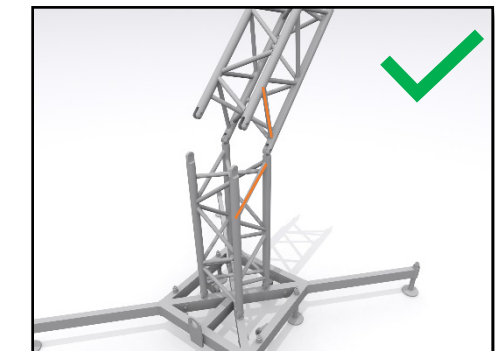
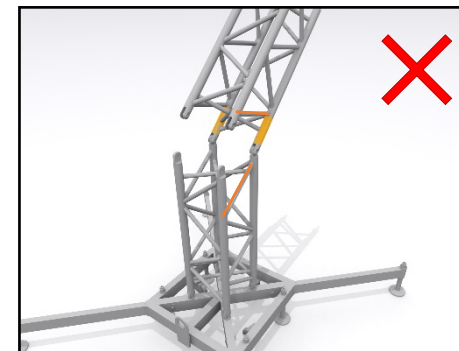

Fig. 45 - GS Truss (when used as a tower) (24.3.1)

- 25.1.6 Slippery surface
- 25.1.7 Surface geometry
- 25.1.8 Potential energy
- 25.1.9 Sharp edges
- 25.2 Additional hazards and hazardous event due to lifting procedures, falling loads, collisions due to:
 - 25.2.1 Gravity and stability
 - 25.2.2 Incorrect loading
 - 25.2.3 Unsuitable connection elements and accessories
 - 25.2.4 Unsuitable selection of lifting devices, equipment and incorrect integration
 - 25.2.5 Incorrect installation, testing, use and maintenance
 - 25.2.6 Incorrect integration of machinery parts
 - 25.2.7 Unintentional movement due to mechanical failure
- 25.3 Electrical hazards
 - 25.3.1 Contact of persons with parts which have become live under faulty conditions
- 25.4 Thermal hazards
 - 25.4.1 Objects or materials with a high or low temperature
- 25.5 Noise hazards
 - 25.5.1 Mechanical noise
- 25.6 Vibration hazards
 - 25.6.1 Loosening of components due to dynamic actions
- 25.7 Ergonomic hazards
 - 25.7.1 Poor body mechanics, posture or excessive effort
 - 25.7.2 Inadequate working light
- 25.8 Hazards associated with the environment in which the product is used
 - 25.8.1 Weather conditions (temperature, wind, ice, lightning etc.)
 - 25.8.2 Seismic activity
 - 25.8.3 Corrosion

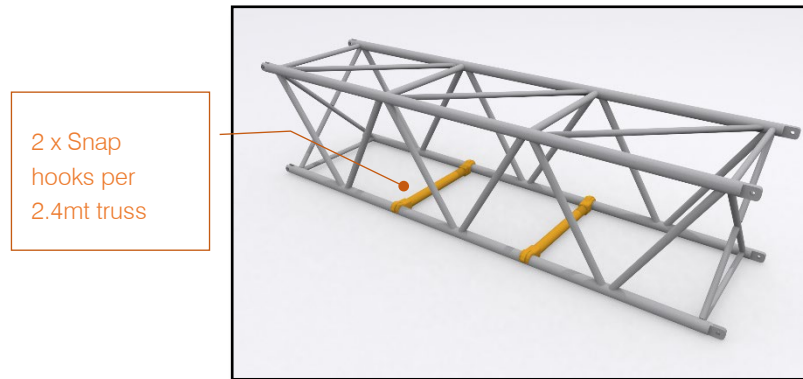

Fig. 46 - Maxibeam Snap Braces (24.4.1)

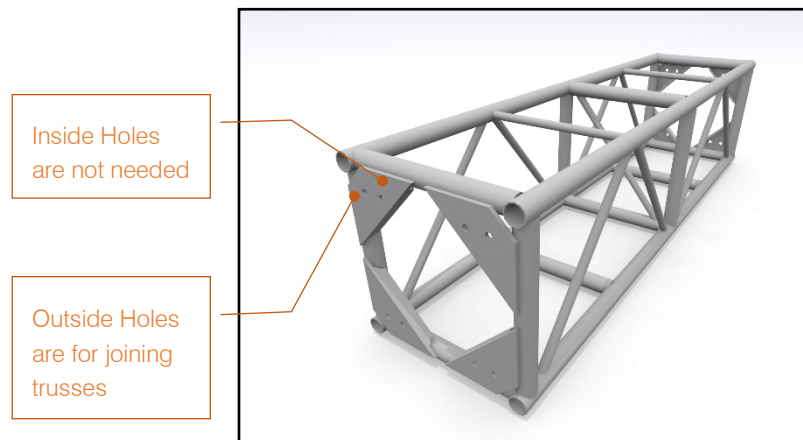

Fig. 47 - Medium Duty Truss (24.5.1)

26 References

- 26.1 The structures and this manual have been designed using the latest editions of all appropriate European Standards and British Standard Codes of Practice. The principal codes are: -
- BS EN 1991; Actions on Structures Part 1-1; General actions – Densities, Self-weights, imposed loads
 - BS EN 1999; Design of Aluminium Structures Part 1-1; General structural rules.
 - BS EN 1993; Design of Steel Structures Part 1-8; Design of joints.
 - BS 8118: Structural Use of Aluminium, Part 2; Specification for materials, workmanship and protection (in older reports).
 - EN 17115 Entertainment Technology – Specification for design and manufacture of aluminium and steel trusses.
 - Temporary Demountable Structures; Institute of Structural Engineers, UK
 - BS EN 82079-1 2012 Preparation of instructions for use structuring, content and presentation Part 1: General principles and detailed requirements.

27 Inspection and Maintenance record

Date:

Inspector:

Inspection record document number:

Result: Passed / Failed

Notes:



Total Solutions Group, Kingston Industrial Estate, 81 - 86 Glover Street, Birmingham, B9 4EN, England
T. +44 (0)121 772 5234 E. sales@trussing.com
www.trussing.com

