



Model MDL1-12S:0.25L

# PULL AND CUT WITH EXTREME PRECISION AND REPEATABILITY

Precisely pull and cut small diameter tubing with a puller/cutter unit designed specifically to enhance the production of microbore tubing. This unit is available as a belt puller, a pinch roll puller, a cutter, or a combination puller/cutter.

The cutter portion of the MedLine is mounted on stainless steel rails with linear bearings that allow the cutter to be moved front-to-back and side-to-side to increase belt life and promote ease of string-up and coiling.

## SIMPLIFIED MICROBORE MEDICAL TUBING PRODUCTION

The MedLine cutter models have a digital position-controlled servo motor that allows the unit to achieve up to 350 cuts/minute at 1000 rpm and a park position of  $\pm 0.1$  millisecond with real-time repeatability monitoring.

The MDL1-12 puller includes either single or dual servo drives with precision planetary gearhead reducers that enhance precise speed control with exceedingly low gear backlash. The puller drive is operated by a digital puller control that allows extremely repeatable velocity profile movements.

The MDL2-12 puller is designed specifically for larger extrudates. This puller is standard with a positional servo motor that includes a servo-rated low backlash reducer.

An optional digital belt gap sensor, with Ethernet capabilities, is available for both puller models.

### ■ Precise pulling with servo motors

Independent servo motors with precision inline planetary gear reducers provide consistent, repeatable pulling with optimum torque and minimum drive system backlash.

### ■ Eliminate belt slippage

The helical offset tooth design and self-tracking belts on the 1-12 puller provide a highly accurate and efficient puller drive system.

### ■ Visible processing

All pinch rolls and cutters, as well as the 1-12 puller and the 2-12 puller, are equipped with 0.25 inch {6.4 mm} thick polycarbonate window guards that ease the string-up procedure by allowing the user to visually follow the microbore tubing through the pulling and cutting processes.

### ■ Cutting capacity up to 2.0 inches

The 0.25L cutter can handle extrudates of up to 0.25 inches {6.4 mm} in diameter. Optional 1 inch {25 mm} or 2.0 inch {51 mm} cut capacities are available with the larger cutter models.

### ■ Touch screen control

The intuitive, 8-inch digital operator control provides a user-friendly method to communicate with the Conair Combination Puller/Cutter. Optional 10-inch dedicated program screens for taper/bump/bubble tubing ease the setup process. An optional 15-inch control is available.



## FEATURES

**Simple Conveyor Setup**

Cutting from above the conveyor improves discharge interface.

**Visible Cutter Head**

Clear knife guard lets you view the rotating cutter head and blade(s) during operation. Designed for easy access!

**Built-in Stainless Steel Particulate/Overflow Tray**

Collects waste lubricant and material with each pass of the cutter blades. A fitting is provided for ease of draining.

**Safety features include:**

- Easy-to-reach emergency stop buttons\*
- Polycarbonate knife guard
- Upper and lower clear polycarbonate belt guards
- Heavy-duty lockdown screws

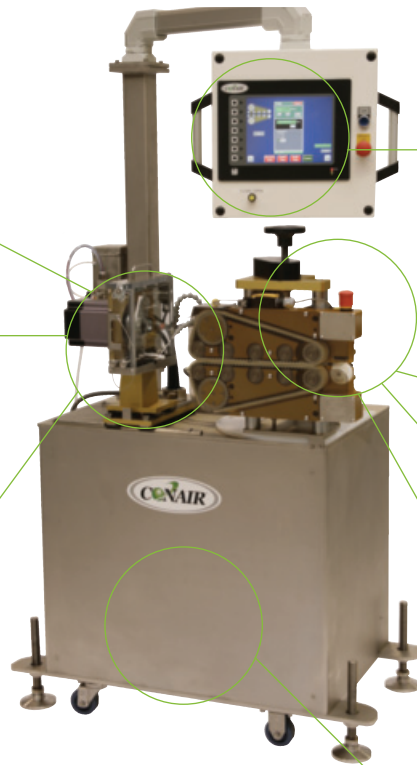

**Optimum Eye-level Monitoring**  
Controls are at eye-level and within easy reach.

**Precisely Control Belt Tension**  
Adjust puller belts and control tension on your material by opening or closing the belts with an easy turn or servo boom. Wheel or servo control. Digital belt gap sensor also available.

**Centered, Guided Material**  
An adjustable roller guides material onto the puller belts.

**Precise Pulling**  
Opposing belts uniformly draw material through to the cutter.

**Stainless Steel Cabinet**  
An optional stainless steel cabinet is available for medical applications.

\*The MedLine models include two independent emergency shutdown switches that, once pressed, will disconnect power to the entire unit and must be reset to restart the puller/cutter.

## PULLER FEATURES/OPTIONS

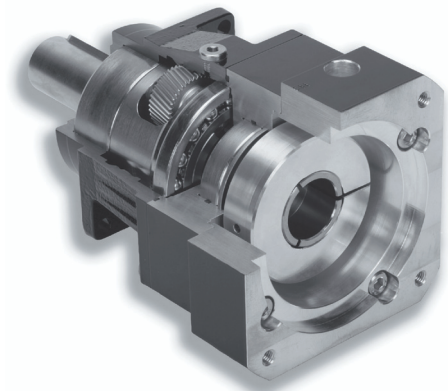

Keep your process running smooth with independent precision planetary gearhead reducers. The MedLine pullers feature helical gearing and gear tooth microgeometry reducers that allow you to produce flaw-free product.

- **Independent servo puller motors** with low backlash planetary gearheads.
- **Choice of in-line planetary gear reducer ratios.** Reducer ratios can be selected to optimize puller performance based on your application.
- **Remote belt speed control option.** *Exclusive* remote control digital potentiometer eases start-up by allowing you to conveniently adjust your belt puller speed while making extruder adjustments. You can dial in your precise speed with the 36 position rotary control knob; virtually eliminating variations due to voltage/noise fluctuations associated with analog controls.
- **Digital belt gap sensor and readout option.** Allows you to set and measure belt gap, to three decimal places, for consistent belt traction.
- **Optional intuitive taper/bump/bubble software.** A digital, positional control is added to the puller servo drive along with a programmable controller (PLC) enabling you to program up to 32 speed variations and 32 analog air pressure adjustments that can be stored for repeatable tube profiling. This combination of air pressure and speed control allow you to produce a high quality, consistent end-product.
- **3 inch {76 mm}, 4 inch {102 mm}, or 6 inch {152 mm} dual servo driven pinch rolls.**

## CONFIGURATION AND NAMING

The MedLine Series can be configured in many different ways to suit your application perfectly. All MedLine models have the same cabinet design. The MedLine can be a medical application puller/cutter combination, a medical puller, or a medical cutter.

The model name/number is determined by the configuration that is desired.

### Pulling information

The first digit in the model name following the MDL (MedLine) distinguishes the difference between a belt puller and a pinch roll.

If the first digit is a number, the number represents the width of the puller belt. The second number represents the length of the belt.

If the third digit is the letter R, the puller utilizes a pinch roll puller. The first and second digits represent the pinch roll diameter and width, respectively.

If the unit is a cutter-only MedLine, this first number will be 0-00.

Single or Dual Servo pulling. This spot in the model will be S for single servo pullers, and D for dual servo pullers.

The colon in the model name separates the puller information and the cutter information.

### Cutting information

The second number represents the diameter capacity of the cutter. If the unit is a puller only MedLine, this second number will be 0.00.

Light or Heavy Duty. An L will appear in this space if this is a light-weight model. The H will appear if this is Heavy Duty.

MDL  -  : .

For example, a MDL1-12S:0.25 is a MedLine that has a puller with 1 inch wide belt, 12 inches long, driven by a single servo. It has a cutter capable of cutting 0.25 inch diameter material.

A MDL6-3RD:0.00 is a MedLine that has a pinch roll 6 inches in diameter, 3 inches wide, driven by dual servos. It has a no cutting head.

## CONFIGURATION AND NAMING

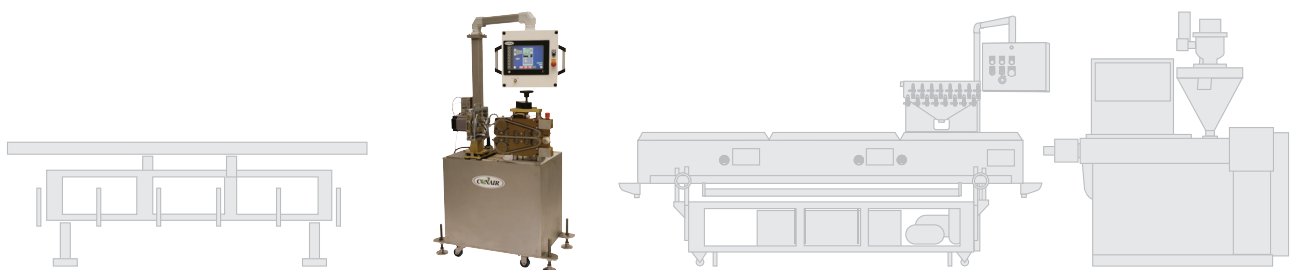

The MedLine is used in-line, downstream from the extruder and tank, to pull, cut, or pull and cut product which can then be transferred to a Medical Take Away Conveyor or coiled onto a Conair ATC coiler.

# CONFIGURING THE RIGHT MEDLINE FOR YOU

## MEDLINE MODELS

Cutters available as L-Light weight or H-Heavy Duty

Cutter 2.00  
(2.25 inch bushing diameter)

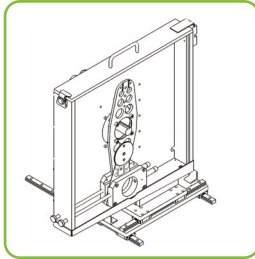

Cutter 1.00  
(1.25 inch bushing diameter)

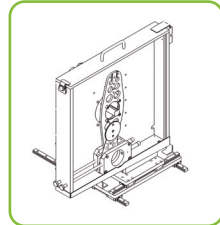

Cutter 0.25  
(0.75 inch bushing diameter)

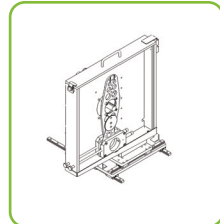

No cutter

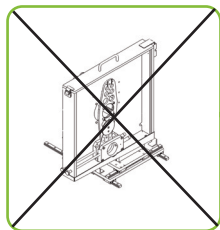

MTAC (connected to control)

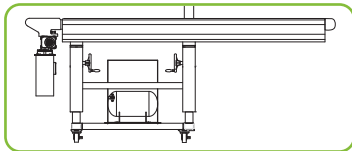

No MTAC

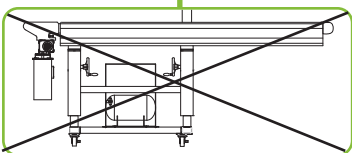

10-inch HMI MedLine control (w/bump tube)

15-inch HMI MedLine control (w/bump tube)

8-inch HMI control (Not bump tube capable)

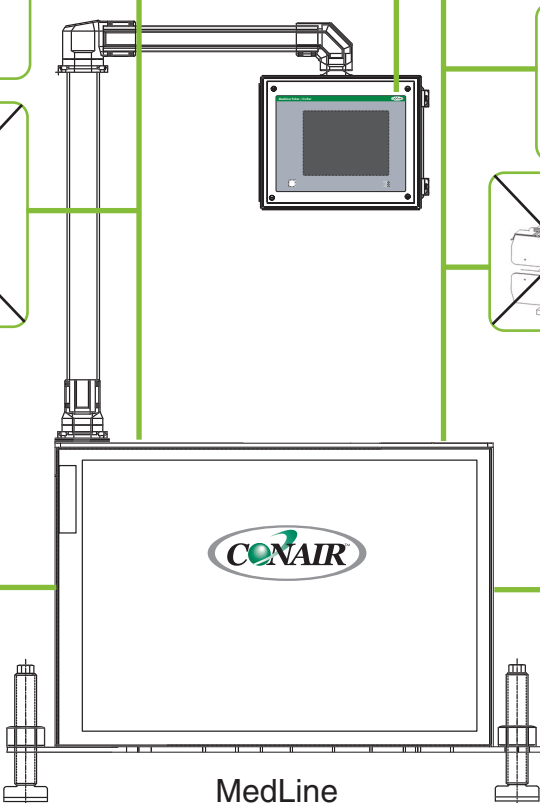

MedLine

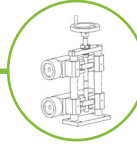

Pinch roll 3-1R (3.12 inch diameter, 1.3 inches wide. Maximum opening 4.0 inches. Single servo only.)



Pinch roll 4-2R (4.12 inch diameter, 2.0 inches wide. Maximum opening 3.0 inches. Single servo only.)

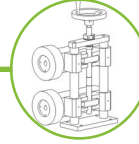

Pinch roll 6-3R (6.06 inch diameter, 2.25 inches wide. Maximum opening 3.0 inches. Dual servo only.)

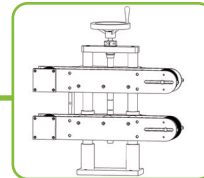

Puller 3-20 (3 inches wide, 20 inches long. 3 inch opening.)

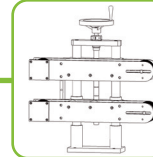

Puller 2-12 (2 inches wide, 12 inches long. 3 inch opening.)

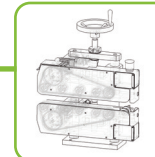

Puller 1-12 (1 inch wide, 12 inches long. 2 inch opening.)

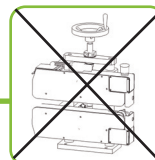

No puller

Lazy susan

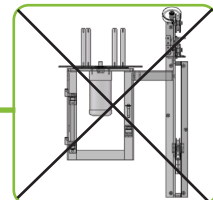
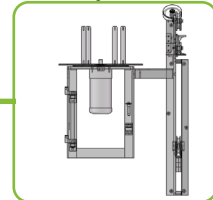

No lazy susan



# CONTROL

# MEDLINE MODELS



Touch Screen Control features include:

- Large, easy-to-read display
- Total access to servo drives for tuning and serviceability
- Upload and download capabilities
- Ethernet communications
- Optional bubble/taper tube screens

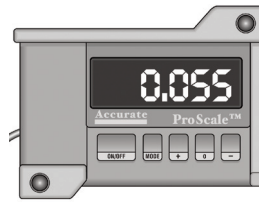

**Digital Belt Gap Sensor**  
This option allows you to set the zero point for the belt gap, and then set and measure belt gap to three decimal places.

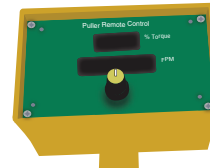

**Digital Remote Control**  
This optional control allows the puller's speed to be fine-tuned from down the line to 36 programmable settings.

# OPTIONS

- Stainless steel cabinet
- Left-to-right puller motion
- Variable blade speed in both demand and flywheel cutting modes
- Bushing lubrication system
- Scrap mode
- 2-inch cut capacity
- Bushing sizes to 2.25 inch {57mm}
- Multiple length and batch counts
- Follower cutting mode
- Digital belt gap sensor
- Tapered/bubble control tube/profile software
- Gauging interface
- Pinch roll puller units

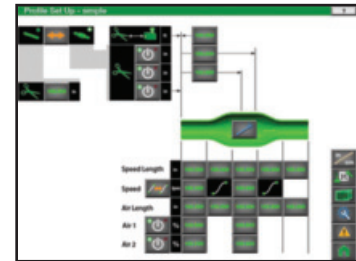

# DIMENSIONAL SPECIFICATIONS

MODELS	MedLine*			
<b>Performance characteristics</b>				
Extrudate capacity inches {mm} dia	0.25 - 2.00 {6.4 - 50.8}			
Blade drive motor (3000 rpm) cutter Hp {kW}	3.25 - 4.4 {2.4 - 3.3}			
Servo puller drive motor Hp {kW}	1.0 - 3.25 {0.75 - 2.4}			
<b>Dimensions inches {mm}</b>				
A - Height	71.0 {1803.4}			
B - Height to centerline, ±2 {±50.8}	42.0 {1067.0}			
C - Width	40.0 {1016.0}			
D - Depth	27.0 - 36.0 {685.8 - 914.4}			
Belt width ±3/8 {±9.5}	1.0 - 3.0 {25.4 - 76.2}			
Belt traction length	12.0 - 20.0 {304.8 - 508.0}			
<b>Reducer ratio/belt speed</b>				
	28:1	16:1	7:1	5:1
Available speeds† ft/min	1.4 to 140	2.5 to 250	5.5 to 550	10 to 700
<b>Weight lb {kg}</b>				
Installed	715.0 - 790.0 {324.0 - 358.4}			
Shipping	700.0 - 800.0 {317.5 - 363.0}			
<b>Electrical requirements full load amps</b>				
Drive type (Puller)	Single or dual servo with precision planetary gearhead			
	1 - 3.25 Hp {0.75 - 2.4 kW}			
	Single servo	Dual servo		
230V/3 phase/60Hz	13 - 20	16 - 30		
460V/3 phase/60Hz	7.5 - 12	9.5 - 16.5		
<b>HMI control</b>	Touch screen			

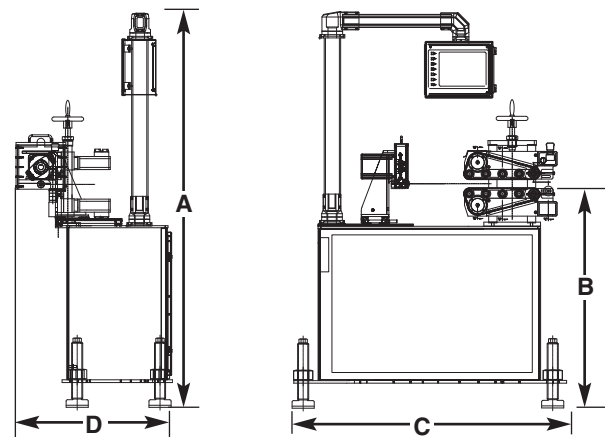

### SPECIFICATION NOTES

\* Specifications will vary based upon configuration selected. See the next page for specifications for individual components.

† Examples of possible speeds are shown. Belt speeds will vary depending on drive type (single or dual).

Specifications may change without notice. Check with a Conair representative for the most current information.





MEDLINE MODELS

PULLING COMPONENT SPECIFICATIONS

PINCH ROLL PULLER MODELS	3-1	4-2	6-3
<b>Performance characteristics</b>			
Roller width inches {mm}	1.30 {33}	2.00 {51}	2.26 {57}
Roller diameter inches {mm}	3.20 {81}	4.12 {105}	6.06 {154}
Feed opening inches {mm}	4 {102}	3 {76}	3 {76}
Drive type	servo (single)	servo (single)	servo (dual)
Roller drive motor Hp {kW}	2 {1.5}	2 {1.5}	3.25 {2.4}
Roller speed* ft/min {m/min}	up to 250 {76}	up to 500 {152}	up to 1200 {366}

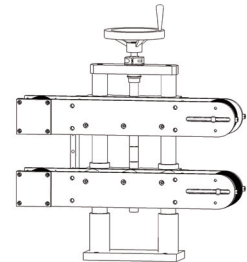
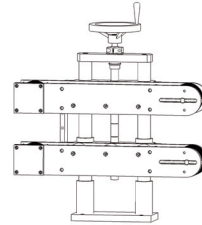
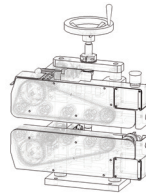
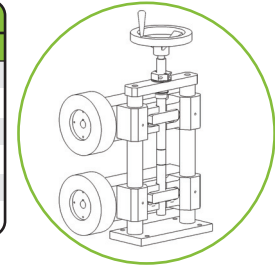

BELT PULLER MODELS	1-12	2-12	3-20
<b>Performance characteristics</b>			
Belt width inches {mm}	1.0 {25.4}	2.0 {50.8}	3.0 {76.2}
Belt traction length inches {mm}	12.0 {304.8}	12.0 {304.8}	20.0 {508.0}
Feed opening inches {mm}	2.0 {50.8}	3.0 {76.0}	4.0 {101.6}
Drive type	servo (single or dual)	servo (single or dual)	servo (single)
Belt drive motor Hp {kW}	(2) 1.0 Hp {0.75 kW}	(2) 2.0 Hp {1.5 kW}	(2) 2.0 Hp {1.5 kW}
Belt speed ranges* ft/min {m/min}	1.4 - 140 {36 - 3600} 2.5 - 250 {64 - 6350} 5.5 - 550 {140 - 13970} 10 - 750 {254 - 19050}	1.4 - 150 {36 - 3810} 2.5 - 250 {64 - 6350} 5.5 - 550 {140 - 13970} 10 - 700 {254 - 17780}	1.4 - 150 {36 - 3810} 2.5 - 250 {64 - 6350} 5.5 - 550 {140 - 13970} 10 - 700 {254 - 17780}

CUTTING COMPONENT SPECIFICATIONS

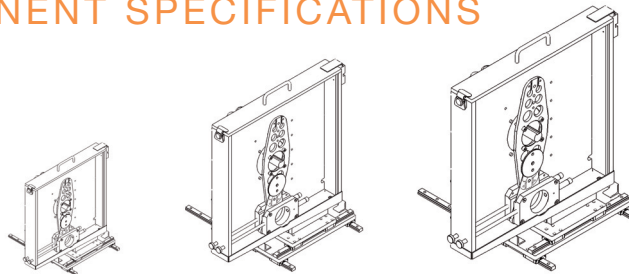

CUTTER MODELS	0.25L	1.00L	2.0L	2.0H
<b>Performance characteristics</b>				
Extrudate capacity inches {mm} diameter	0.25 {6.35}	1.00 {25.4}†	2.00 {50.8}†	2.00 {50.8}
Bushing inches {mm} dia.	0.75	1.25	2.25	2.25
Blade drive motor Hp {kW}	3.25 {2.4}	3.25 {2.4}	4.4 {3.3}	4.4 {3.3}
High torque motor‡	N/A	4.4 {3.3}	STD	STD
Feed direction	right-to-left	right-to-left	right-to-left	right-to-left
<b>Cutter head</b>				
Aluminum 2-position	Yes	Yes	NA	NA
Stainless steel 2-position‡	NA	Yes	STD	STD
Slide Base‡	Yes†	Yes†	Yes†	Yes†

**SPECIFICATION NOTES**

\* Examples of possible speeds are shown. Belt speeds will vary depending on drive type (single or dual).

† Dependent on material and wall thickness.

‡ Optional.

Specifications may change without notice. Check with a Conair representative for the most current information.

