

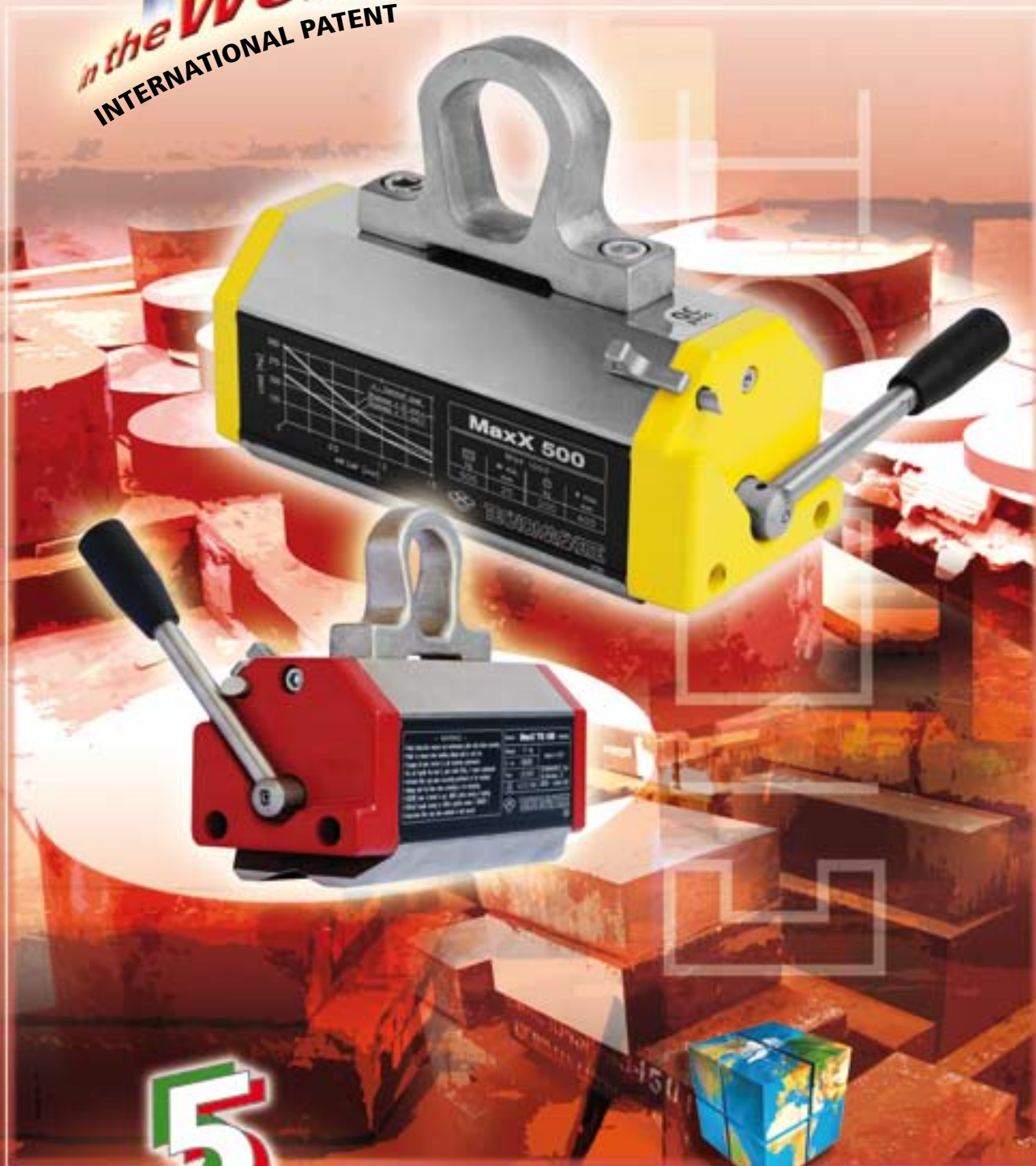

# MaxX<sup>®</sup>

The hand controlled  
magnetic lifter

N° 1 in the world



**5**  
years  
warranty

**TECNOMAGNETE<sup>®</sup>**  
Safety Through Power

# MaxX<sup>®</sup>

Hand controlled  
magnetic lifters

**A wide Choice of Quality**



**MaxX 125**

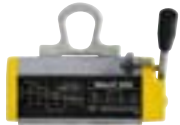

**MaxX 250**



**MaxX 500**



**MaxX 1000**



**MaxX 1500**



**MaxX 2000**



The innovative technological concept and the superior performances make MaxX the absolute reference in the field of magnetic lifting of ferrous loads.

**Powerful, compact, safe, reliable and competitive** are the key factors of the MaxX line's success all over the world.

MaxX lifters are the ideal solution for handling a large variety of work pieces, from flats to rounds, from finished to rough, with easy and ergonomic operation in total safety.

The operating costs are near to zero, efficiency and productivity are dramatically increased and the return of the investment is extremely quick.

The handy and practical use of MaxX lifters is possible, due to their compact size and limited weight that allows also to optimize space and to exploit crane capacity.

A wide range of models are available with capacities ranging from 125 Kg. ( 275 lbs) up to 2000 Kg. (4450 lbs) and with different versions for load with regular and reduced thickness.



**TECNOMAGNETE**  
Safety Through Power

# MaxX<sup>®</sup> Energy

## The best expression of power

Through a qualitative selection of top grade energy magnets and a further optimization of the tolerances between the stator and the rotor, it has been possible to achieve a "Plus" version of the model MaxX 250 a MaxX 500.

With the same size and weight these models will give 20% more performances thus being labelled MaxX 300 and MaxX 600 "Energy version".



# MaxX<sup>®</sup> TG

## Greater flexibility with thin gage loads

MaxX TG has been conceived to meet the demand for handling low thickness steel loads in a safe and efficient way.

The special design of the polar surface together with a proper balancing of the magnetic masses located in the stator and in the rotor, allows the magnetic flux to be concentrated at a closer distance.

The rotation of the handle remains gentle whilst keeping high characteristics of uniform magnetic strength over the whole contact area.



**MaxX TG** makes it possible to de-stack plates starting from 5 mm. thickness using 2 lifters with a MFB beam.



## Lifters

# MaxX<sup>®</sup>

## The ultimate generation

The most practical, safe and economical way to handle ferrous loads.

Hundreds of thousands of units already installed all over the world are the confirmation of great value brought to many industrial sectors, including:

- tool and die makers
- machinery builders
- cutting and metal forming workshops
- steel distribution centres
- shipyards
- foundries and steel plants
- steel construction and fabrication
- warehousing and transportation

**and in general for the needs of all modern industries, to enhance productivity for a sharp competitive edge.**

A single operator can handle the load which is always anchored and lifted from the top without deformation or damage, making optimal use of the available work space, streamlining working process and improving safety conditions for men and equipment.





**MaxX 125,  
The smallest,  
the most practical**

The compact size allows the MaxX 125 to be used in very narrow spaces and with a limited capacity hoist system. A higher level of flexibility is reached by the rotating hook included as standard equipment



# Safety and simplicity up front

## The activation and deactivation phases

With a simple rotation of the lever, the lifter is activated and deactivated.

During the MAG phase the lever is firmly blocked by a mechanical safety device, preventing any possible accidental deactivation.

The simplicity of a single movement for a constant and predictable result

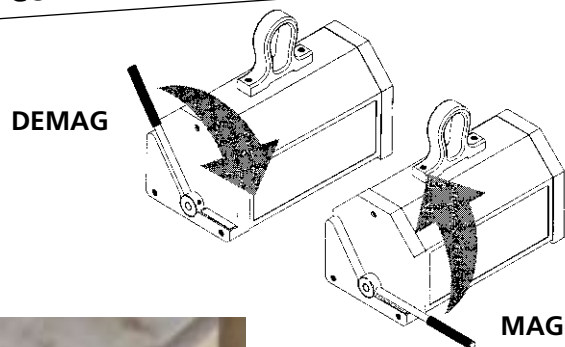

*The locking device is simple and clearly visible to the operator in order to always keep the operative conditions under control.*



*Activation phase with a fluid movement of the lever without tearing.*



## MaxX warns you of possible dangers

The high-energy developed by the permanent magnets and the high concentration of magnetic flux generated exclusively in the polar area, without flux dispersions, enable the operator to notice

when the clamping conditions are not optimal. In fact, in this case the movement of the lever becomes irregular and quite difficult. The operator will be induced to seek

for a more suitable positioning of the lifter immediately perceiving a better fluidity without effort of the lever during the activation phase and thus achieving safer operative conditions.

# Exclusive technology for interactive safety



## MaxX<sup>®</sup> + ATS

With a simple touch, all information on a digital display

The model MaxX 1000 and MaxX 2000 can be supplied with the new integrated and patented Auto Test System, ATS.

The ATS device is able to check the force generated by the MaxX lifter on the specific load and then comparing it with the weight of the load, determined by a loading cell built into the lifting hook.

Whenever the force generated by the lifter is does not exceed at least 2 times the weight of the load, the ATS system activates a light and a sound signal to that warns the operator to stop the undertaken handling operation.

### High autonomy

ATS is powered by standard rechargeable AA batteries.  
Automatic Stand-by: after a few seconds of inactivity, the system shuts down automatically.  
Their autonomy ensures for several thousand activation cycles.

The digital display will show the relevant values in order the operator can get all information to proceed with a safe handling operation.

Simply by pushing a button, before making the MAG phase, the ATS system is activated verifying:

- the force generated by the lifter on the specific load
- the weight of the load to be lifted.

### Power under control

The force generated by the lifter is directly related to the characteristics of the load to be handled. Limited or irregular contact surfaces, dew to rust, paint or other impurities, generate air gaps with consequent partial dispersion of the magnetic flux.  
ATS checks the force related to the morphology of the load and the typology of the material.



With the ATS system activated the capacity of the lifter and the weight of the load to be handled are compared in all handling operations.

Both models can be used the traditional way with a standard safety factor 3 or as an alternative, after actuating the ATS system, assuring responsible handling of heavier loads, by taking advantage of the safety factor 2 assigned to the ATS alarm.



**An all Italian Idea**



**MaxX<sup>®</sup>**

**A revolutionary patent**

The MaxX series is born from an innovative design concept, the result of long and extensive experience of Tecnomagnete in the development and manufacturing of permanent electro magnetic systems for workholding and heavy duty lifting.

The key elements of the MaxX lifter, i.e. the stator and the rotor, are manufactured with a solid block construction without any welding or assembling screws. This grants high constant performances and a high level of durability and reliability throughout time.

**Concentrated power**

The 'neutral crown' circuit, the basic patent of all Tecnomagnete products, allows channelling the magnetic flow through the polar area only, i.e. where the power is needed. This ensures steady and optimal performance while the total absence of magnetic dispersion avoids undesired attraction from adjacent loads.

**Reliability:**

The cycles occur with the simple rotation of a lever, without effort. The only moving part, the rotor, has its fulcrum on ball bearings and doesn't develop any physical contact during rotation.

*Mag phase*

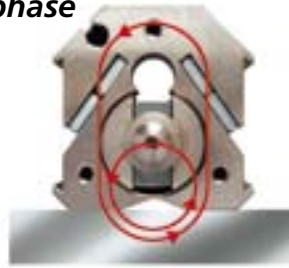

*Demag phase*



*In the activation (MAG) and deactivation (DEMAG) phases the rotor is rotated by the appropriate lever 125 ° allowing the reversal of magnets polarity placed inside and changing the movement of the*

*magnetic flux. The load is held only by the constant force of the permanent magnets and the steel mono-block lifter structure. Total Safety!*

**Modern manufacturing**



**Magnets testing equipment**

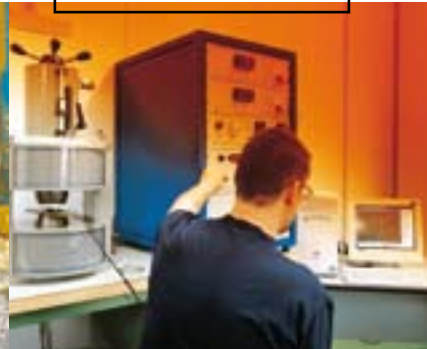

**Dedicated assembly line**

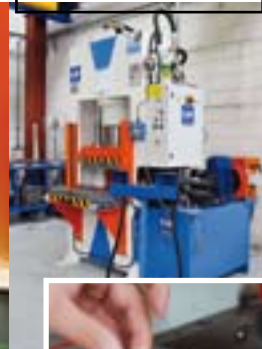

**Safe power:**

High-energy, permanent magnets ensure great concentrated and constant power for an indefinite period. The 1:3 safety factor between the recommended load and the test load ensures optimal working conditions even with substantial operating air gaps.

**Compact and Robust:**

The incredible ratio between power and weight is given by the original double magnet circuit and by the very tight internal tolerances related to the mono block construction.







**TECNOMAGNETE**  
Safety Through Power



**An advanced manufacturing process**

The mono-block construction has allowed to simplify the manufacturing process with less manpower input and with streamlined production flows.

Dedicated high power magnetisation units have been developed to polarize the permanent magnets in a uniform way when the lifter is fully assembled for a perfect balancing of the magnetic flux.

Sophisticated electronic inspection instruments are used to constantly assure the high quality of the permanent magnets.

All MaxX lifters are tested one by one, in order to ascertain that all distinctive product characteristics are met and to certify all operative parameters under the most strict international norms.

Project innovation, material selection, state of the art manufacturing processes, a powerful and reliable product with no maintenance need, convenience in price, have decreed the great international success, making **MaxX the most sold lifter all over the world.**

**Powerful magnetisation unit**



**Individual testing**



**Easy to handle packaging**



**Nickel Treatment**  
Nickel coating of all steel parts prevents rust formation, improves component life and allows better surface hardness in the polar area maintaining optimal load contact conditions and protection of machined surfaces.

**Laser marking for plates**



**5 years warranty**



# A model for every demand

## Safety factor 3

You cannot play with safety. Each lifter is tested to certify the force to be 3 time compared to the Suggested Weight Load (SWL). That means a MaxX 250, with SWL 250 Kg.(550 lbs) generates a force of 750 daN at least.

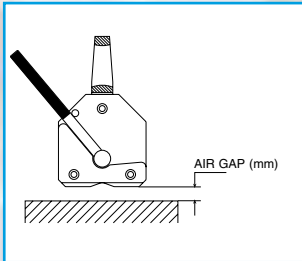

Pull/Air gap curves on common Fe 370B with steel poles completely covered

The behaviour with irregular loads -called "high air gaps" make the differences clear between MaxX and other lifters on the market. Air gaps can mean the loss of contact between the load and the magnet, usually caused by irregular surfaces or by the presence of dirt / paint / ferrous residue on the load.

MaxX allows you to operate in total safety with different typologies of loads, in connection with its highly performing pull/air gap curve.

### MaxX 125



### MaxX 250

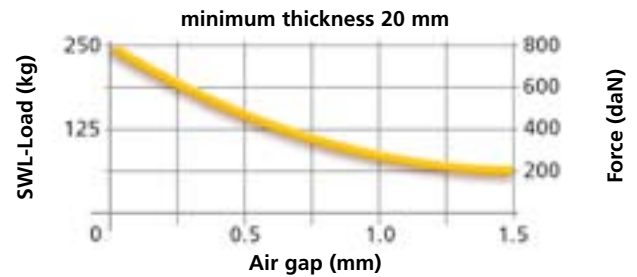

### MaxX 500

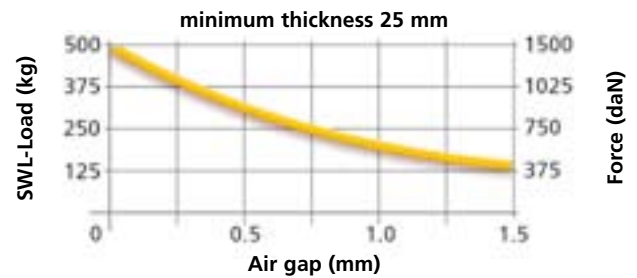

### MaxX 1000

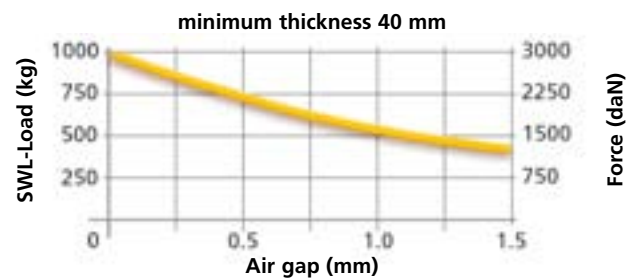

### MaxX 1500

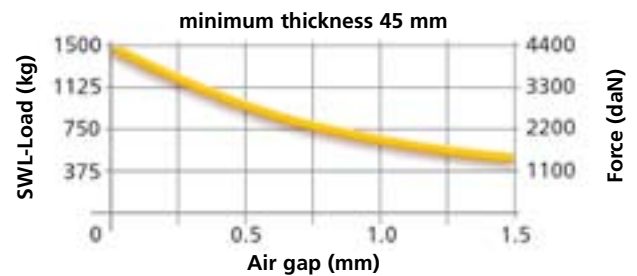

### MaxX 2000

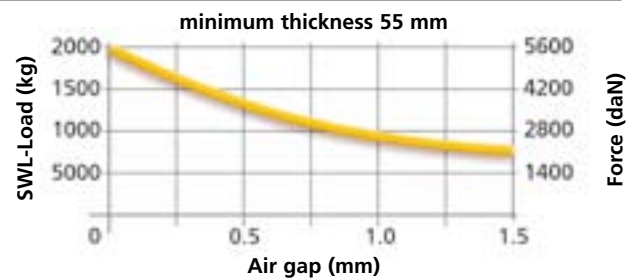

# MaxX®

Energy

## MaxX 300 E

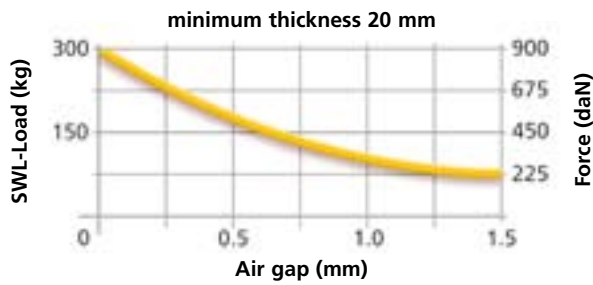

## MaxX 600 E



### For plates



Model	SWL-Load max kg	Thick min. mm	Length max mm
MaxX 125	125	20	1000
MaxX 250	250	20	1500
MaxX 500	500	25	2000
MaxX 1000	1000	40	3000
MaxX 1500	1500	45	3000
MaxX 2000	2000	55	3000
<hr/>			
MaxX 300 E	300	20	1500
MaxX 600 E	600	25	2000
<hr/>			
MaxX TG 150	150	8	1500
MaxX TG 300	300	10	2000

# MaxX<sup>®</sup>TG

## MaxX TG 150

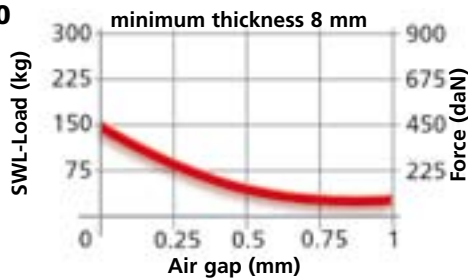

## MaxX TG 300



### For rounds



Model	SWL-Load max kg	Thick min. mm	Length max mm	Ø max mm
MaxX 125	50	10	1000	300
MaxX 250	100	10	1500	300
MaxX 500	200	15	2000	400
MaxX 1000	400	25	3000	450
MaxX 1500	600	30	3000	500
MaxX 2000	800	35	3000	600
<hr/>				
MaxX 300 E	150	10	1500	300
MaxX 600 E	250	15	2000	400
<hr/>				
MaxX TG 150	60	8	1500	240
MaxX TG 300	120	10	2000	290



# Best performances with suitable loads

All magnetic performances are directly related to the physical and morphological conditions of the load to be clamped. In addition to the air gaps, other key issues are related to the thickness of the load, to the type of the material and to the temperature of the load.

## Thickness of the load

As a general rule, the higher the force released by the magnet, the higher the thickness needed to concentrate 100% of the magnetic flux.



## Type of the material

The Higher the concentration of carbon is, the lower the magnetic force is induced on the load.

## Temperature

All mentioned performances are granted up to 80 C° (176 F) on the load contact surface.

## Force to thickness

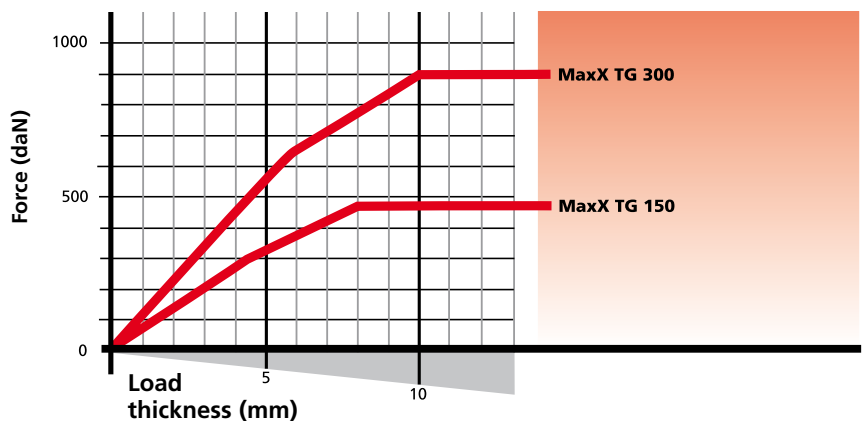
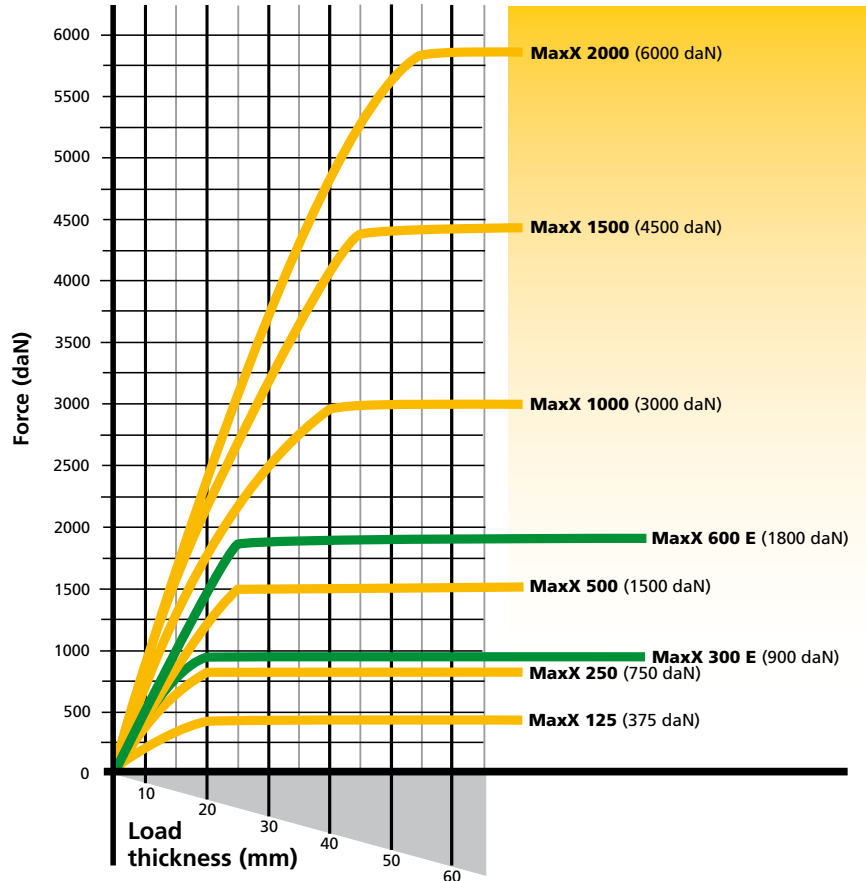

## Force to material

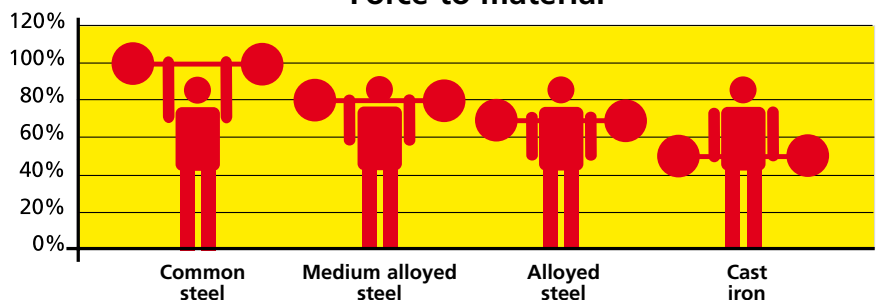

# Size, weights and dimensions

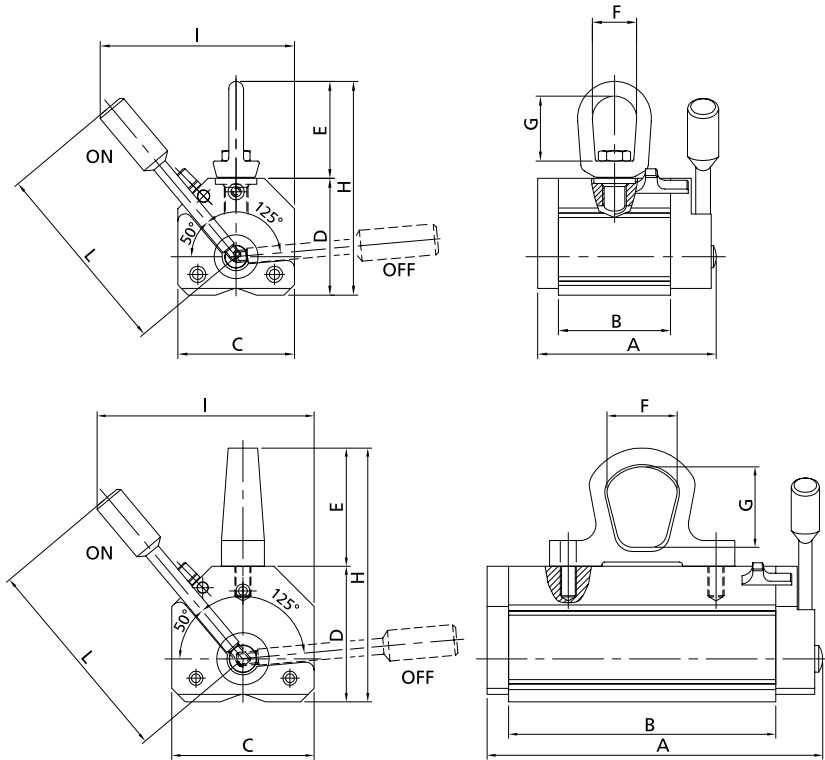

Model	Weight kg	Dimensions mm									
		A	B	C	D	E	F	G	H	I	L
<b>MaxX 125</b>	3,7	121	76	79	79	66	30	44	145	132	137
<b>MaxX 250</b>	6	189	143	79	79	63	35	43	142	130	137
<b>MaxX 500</b>	15	250	199	106	101	88	52	60	189	165	170
<b>MaxX 1000</b>	36	342	284	133	131	88	52	60	219	225	240
<b>MaxX 1500</b>	66	383	316	166	171	122	64	87	293	330	377
<b>MaxX 2000</b>	80	457	390	166	171	122	64	87	293	330	377
<b>MaxX 300 E</b>	6	189	143	79	79	63	35	43	142	130	137
<b>MaxX 600 E</b>	15	250	199	106	101	88	52	60	189	165	170
<b>MaxX TG 150</b>	6	189	170	79	87	63	35	43	150	130	137
<b>MaxX TG 300</b>	16	250	230	106	101	88	52	60	189	165	170

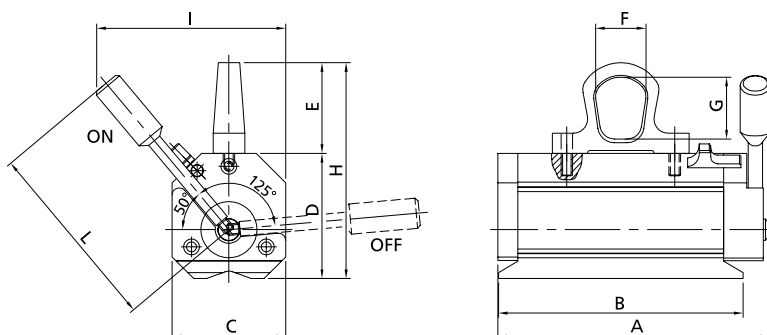

## Dedicated tools

### To get the best performance

Tecnomagnete suggests a line of devices for MaxX lifters to increase the flexibility of use in many applications for horizontal and vertical handling.

Their solid block construction make them very sturdy and reliable over the time with no maintenance.



### MFB MaxX Fixed Beam

The MFB beam allows the perfect coupling of MaxX lifters, allowing the handling of big size loads.

(4450 lbs) versions, adaptable to all types of MaxX lifters.

MFB is available in MFB500 for load up to 500 Kg. (1110 lbs) and MFB2000 for load up to 2000 Kg.

The distance of the 2 lifting hooks, included in the standard specification, can be easily changed using the 5 pre-arranged positioning slots.

#### Dimensions and Weights (mm)

##### MFB 500

A (mm)	1680
B (mm)	300
C (mm)	130
D (mm)	15
Weight (kg)	37

##### MFB 2000

A (mm)	1900
B (mm)	415
C (mm)	160
D (mm)	18
Weight (kg)	75

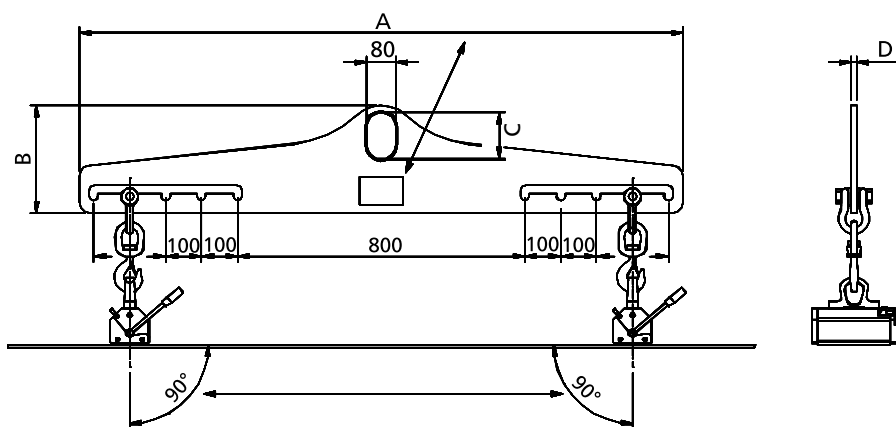

#### Technical Characteristics / load capacity

##### MFB 500

in combination with:	SWL-Load (kg)	Plates		Rounds	
		Max Length (mm)	Max Width (mm)	SWL-Load (kg)	Max Length (mm)
2 MaxX 250	400	3000	1500	200	3000
2 MaxX 300 E	500	3000	1500	200	3000
2 MaxX TG 150	200	3000	1500	100	3000
2 MaxX TG 300	500	3000	1500	250	3000

##### MFB 2000

in combination with:	SWL-Load (kg)	Plates		Rounds	
		Max Length (mm)	Max Width (mm)	SWL-Load (kg)	Max Length (mm)
2 MaxX 500	800	3000	1500	400	3000
2 MaxX 1000	1500	3000	1500	750	3000
2 MaxX 1500	2000	3000	1500	1000	3000
2 MaxX 2000	2000	3000	1500	1000	3000
2 MaxX 600 E	900	3000	1500	500	3000



## MVS MaxX Vertical System

MVS system is designed for the vertical handling of steel blocks.

The typical application is loading/unloading a workpiece on a horizontal spindle milling machine.

Using simple stalls, it's possible to fix the workpiece to the magnetic chuck from one side to the other, so as to work both faces.

MVS is easily adaptable to workpieces of different sizes, by changing the position of locking pins.

MVS is available for MaxX 250/500/1000.

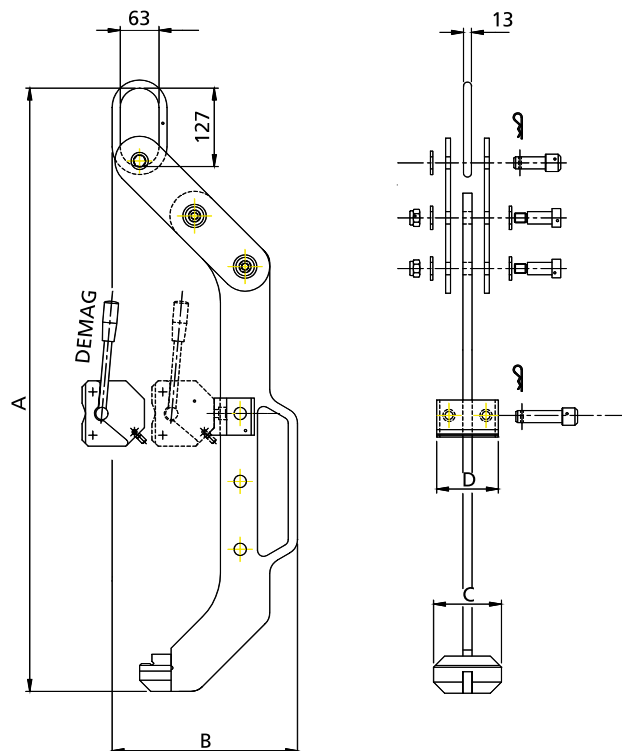

### Dimensions and Weights

Model	MVS 250	MVS 500	MVS 1000
A (mm)	803	976	1075
B (mm)	265	300	332
C (mm)	110	140	140
D (mm)	100	160	160
Weight (kg)	10	18	19

### Technical Characteristics

Model	MVS 250	MVS 500	MVS 1000
Load Max (kg)	180	350	700
Max length plate (mm)	800	1000	1000
Max height plate (mm)	550	700	800

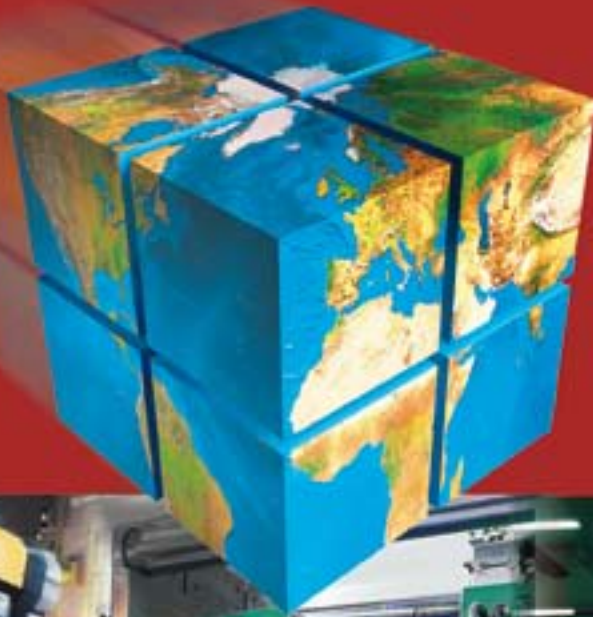

# A world of magnetic solutions

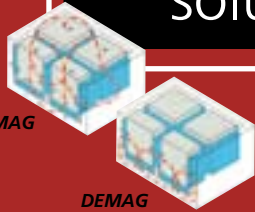

Here is a strong statement:  
Tecnomagnete has revolutionized  
the world of work holding!  
Do you want a stronger one?  
The QuadSystem!

This permanent electro magnetic system generates a concentrated and predetermined force that is highly effective to clamp steel parts on machine tools, moulds for injection molding and dies for metal stamping machines, and the handling of ferrous loads.

We've believed in the force of our QuadSystem patent and many companies have believed in this powerful innovative technology. The large variety of applications of over 100,000 systems sold world wide give all our customers a sharp competitive edge with safety and flexibility.

Nowadays, with the global network of our subsidiaries and commercial partners we are at your disposal to show you state of the art technical solutions for all applications and increase your success.

*Tecnomagnete: all the magnetism of the leader.*



Headquarters:  
**TECNOMAGNETE spa**  
20020 Lainate (MI) Italia, Via Nerviano 31  
Tel. +39 02.937.591, Fax +39 02.935.708.57  
e-mail: info@tecnomagnete.it

[www.tecnomagnete.com](http://www.tecnomagnete.com)

- Subsidiaries:
- Germany: Tecnomagnete GmbH
- France: Tecnomagnete SARL
- Sweden: Tecnomagnete AB
- Usa: Tecnomagnete Inc
- Japan: Tecnomagnete Ltd
- China: Tecnomagnete RO
- Singapore: Tecnomagnete RO
- Korea: Tecnomagnete RO
- India: Tecnomagnete RO

Distributor

