

**WISE
CLAMPER**

WISE-CLAMPER SERIES

kitagawa



WISE-CLAMPER

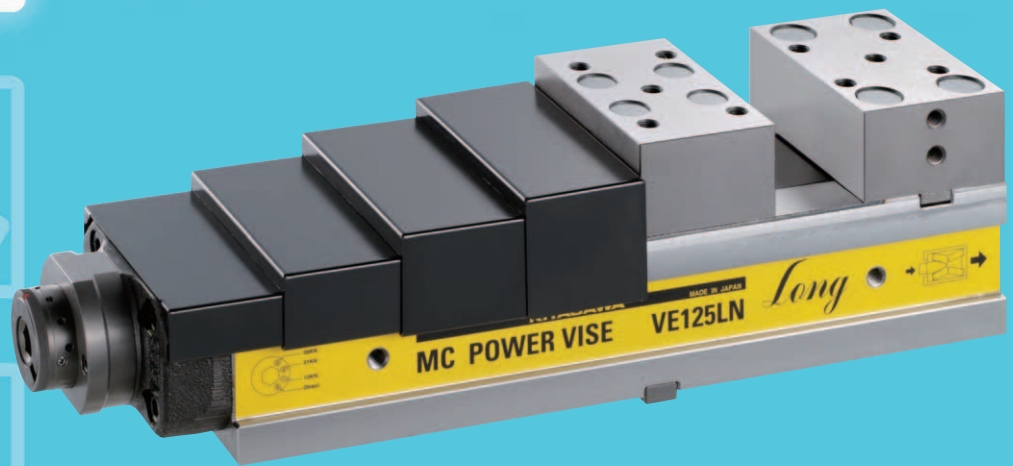

Head Quarters, Motoyama factory



WISE

Features of KITAGAWA MC Power Vises

● Compact Design!

The overall length is ultra-compact with the largest jaw opening in products of the same class!

The vise overall length is fixed regardless of the jaw opening position.

With the low height body, the jaw height is the most excellent in products of the same class!

A wide machining area can be ensured.

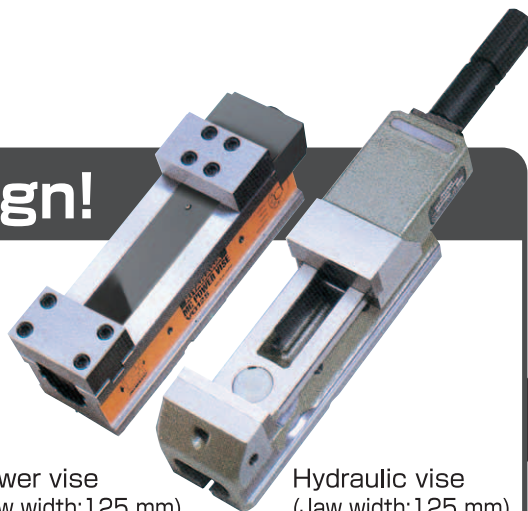

Power vise
(Jaw width: 125 mm)

Hydraulic vise
(Jaw width: 125 mm)

● Firm, Stable and Easy Clamping!

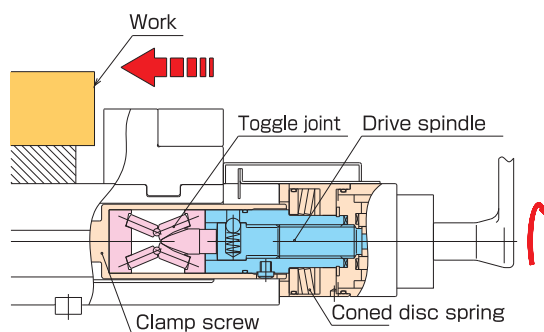

[Before enhancement]

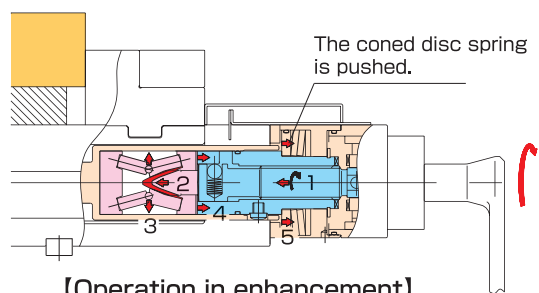

[Operation in enhancement]

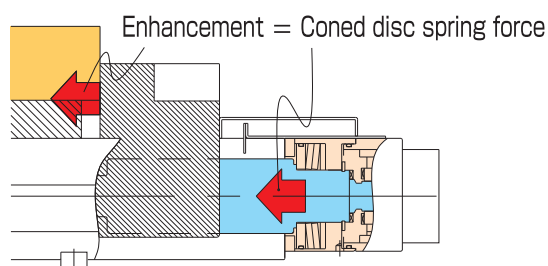

[After enhancement]



A maintenance-free enhancement mechanism, "toggle joint mechanism", has been incorporated, thus realizing the stability in spite of a high clamping force. The preset system makes clamping force adjustment easy. In addition, manual clamping without enhancement is possible, which has extraordinarily improved the usability. A stable clamping force enables accurate and reliable positioning.

● Work lift-up Reduced to 0.015 mm or less!

A binding beam method (work lift-up prevention mechanism) which has a pull-in effect in clamping has been adopted. This mechanism has reduced work lift-up to 0.015 mm or less.

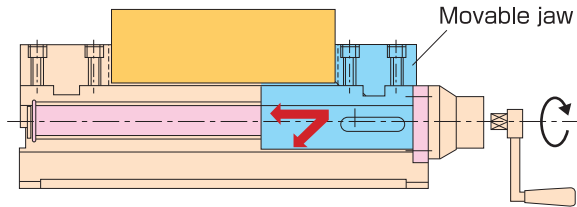

● Easy Jig Mounting!

Tapped holes are provided on the top faces of both jaws. Those make jig mounting easy, enabling various kinds of machining operations.

● Chip Guard Cover

The attached C-caps can be mounted on the top-face bolt holes of both jaws, which prevents from gathering chips and cutting water.

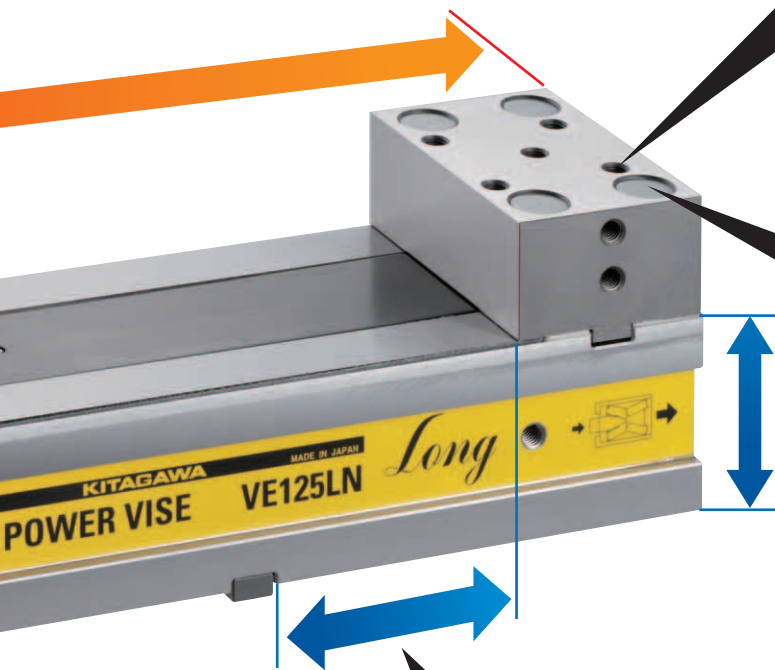

● Parallel Specification Adopted as Standard!

The KITAGAWA vises are precise systems, which have realized the dimensional tolerance of 0.01 mm or less. The parallel specification has been available as standard. With this specification, long-size work can be firmly gripped, thus stabilizing the machining accuracy. Multiple workpieces can be machined simultaneously, which makes this vise suitable for high volume production.

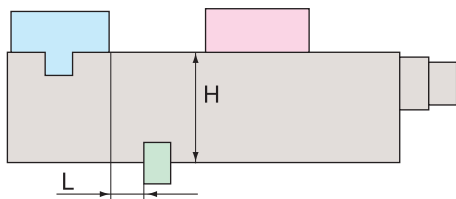

H-dimension tolerance **0.01** mm or less
L-dimension tolerance **0.01** mm or less

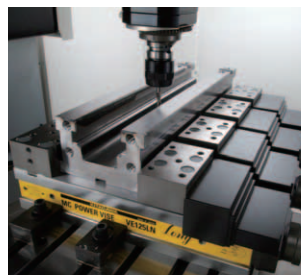
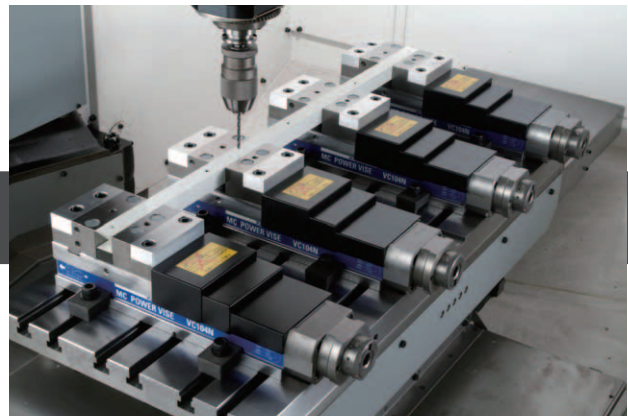

※Even long-size work can be firmly gripped!

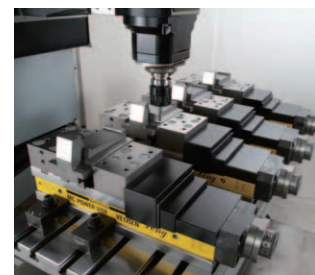

※Multiple workpieces can be machined simultaneously!



WISE

Features of KITAGAWA MC Power Vises

■ Clamping force table

A clamping force suitable for workpiece can be set at the following table.

(Unit : kN)

Range		4	3	2	1	0
Model	VC103N VC104N	—	20	15	10	8
	VE100N	—	25	17	9	8
	VQX100N VM100N	—	30	21	12	8
	VE125N VE125LN VE125LWN	—	30	21	12	8
	VQX125N VM125N	—	40	28	16	8
	VE160N VE160LN	—	45	32	20	10
	VQX160N	60	46	32	18	10
	VE200N VE200LN	—	45	32	20	10
	VQX200N	70	54	38	22	10
	MH125N-4 MV125N	—	40	28	16	8

※Since range 0 is clamping force without any influence of the enhancement mechanism, the clamping force shows the allowable capacity.

■ Clamping Force Setting (Range Switching) Method

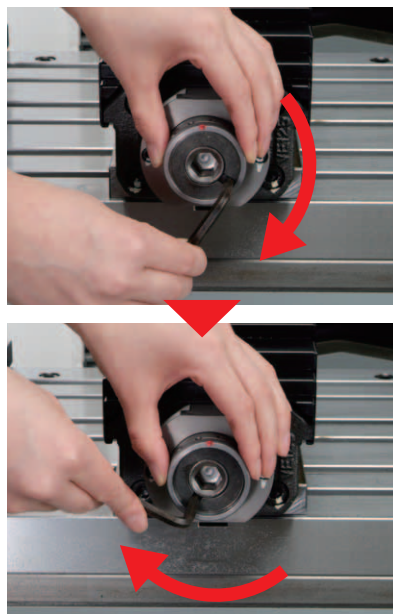

1. Release the work.
2. Hold and fix the knurled part on the periphery of the handle slot (left hand in the photograph).
3. Insert the attached L-shaped hexagonal wrench into the notch on the handle slot end (right hand in the photograph).
4. Turn the L-shaped hexagonal wrench to set to the desired range.

■ Soft jaws matched to work form can be used.

Option _____

Soft jaws (blank) are available.

[Movable side]

[Fixed side]

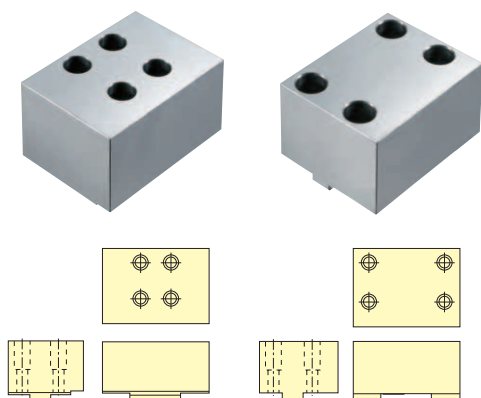

■ Allowable jaw dimensions for clamping force

(Unit : mm)

Model	Range	4	3	2	1
VC103N VC104N	Jaw height	—	40 (std.)	60	110
	Jaw width	—	100 (std.)	120	175
VE100N	Jaw height	—	40 (std.)	60	110
	Jaw width	—	100 (std.)	120	175
VQX100N VM100N	Jaw height	—	35 (std.)	50	90
	Jaw width	—	100 (std.)	115	150
VE125N VE125LN VE125LWN	Jaw height	—	50 (std.)	70	125
	Jaw width	—	125 (std.)	150	210
VQX125N VM125N	Jaw height	—	40 (std.)	60	100
	Jaw width	—	125 (std.)	145	190
VE160N VE160LN	Jaw height	—	60 (std.)	85	135
	Jaw width	—	160 (std.)	190	250
VQX160N	Jaw height	45 (std.)	60	85	150
	Jaw width	160 (std.)	180	210	280
VE200N VE200LN	Jaw height	—	70 (std.)	100	160
	Jaw width	—	200 (std.)	245	340
VQX200N	Jaw height	55 (std.)	75	105	175
	Jaw width	200 (std.)	220	260	350
MH125N-4 MV125N	Jaw height	—	40 (std.)	60	100
	Jaw width	—	125 (std.)	145	190

※For the KITAGAWA's optional soft jaws, only one type is available. For details, see the information on page 21-22.

Accuracy spec./performance table

Static accuracy

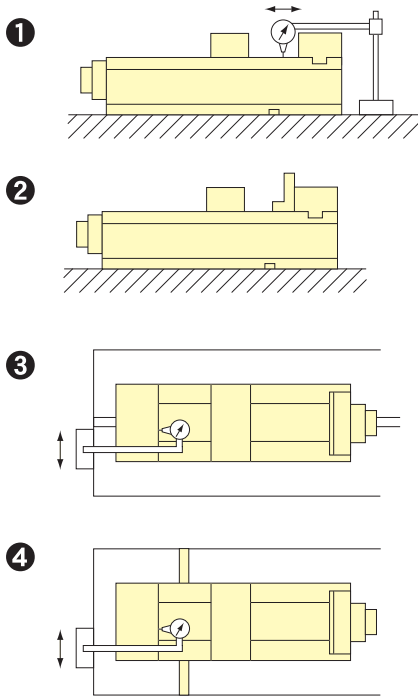

(Unit : mm)

No.	Inspection item	Allowance (mm)	TES 2201-2005
1	Parallelism of body bottom face and jaw slideway	0.010 per 100	0.015
2	Squareness of fixed jaw clamp face and jaw slideway (Not to be outside opening.)	0.010 for total jaw height	0.030
3	Squareness of guide block side of body bottom face and fixed jaw clamp face	0.015 per 100	0.015
4	Parallelism of guide block side of body bottom face and fixed jaw clamp face	0.010 on full jaw width	0.015

※TES=Japan machine accessory association (JMAA) standards

Dynamic accuracy (by KITAGAWA test regulation)

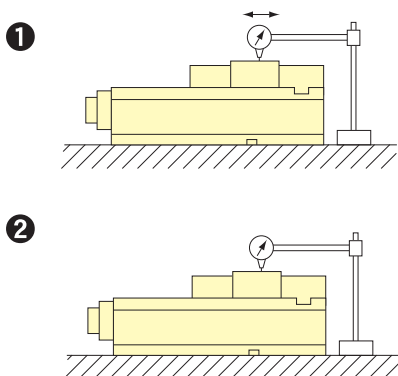

(Unit : mm)

No.	Inspection item	Allowance (mm)	TES 2201-2005
1	Parallelism of upper face of clamped test block and body bottom face	0.015 per 100	0.020
2	Upper face lift of test block in clamping	0.015	0.030

※TES=Japan machine accessory association (JMAA) standards

※Note) The standards for accuracy above is for Vises. It's for VAX and VAX125C etc. do not exist.



INDEX [Product description]

Vises for Small-Size Machines

VC-N series

VC103N · VC104N

P. 7

MC Power Vise Multi-type

VM-N series

VM100N · VM125N

P.16

Lowest profile Type Steel Vises

VE-N series

VE100N · VE125N · VE160N · VE200N

P. 9

Multi-Power Vise Vertical 4-Piece Integrated Type

MV125N

P.17

Lowest profile Type Long Steel Vises

VE-LN series

VE125LN · VE160LN · VE200LN

P.11

Multi-Power Vise Horizontal 4-Piece Integrated Type

MH125N-4

P.18

Lowest profile Type Longest Steel Vises

VE125LWN

P.11

MC Air Vise

VQA125N

P.19

MC Power Vise

VQX-N series

VQX100N · VQX125N · VQX160N · VQX200N

P.13

KITAGAWA Vise Accessories

P.20

Potal Machining Centre

VE125N-15 · VQX125N-15

P.15

MC Compact Clamper VAX125

VAX125 · VAX125C

P.23

■ Name of Each Part

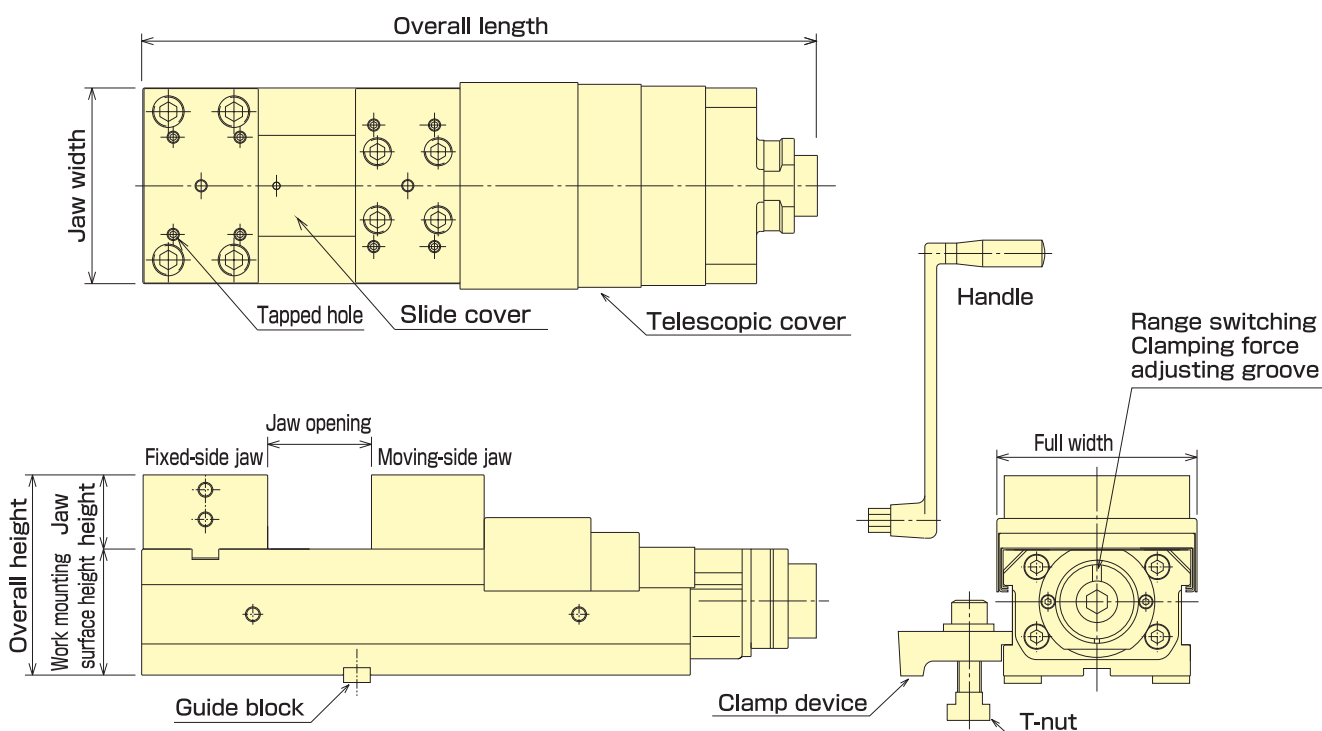

Specification Comparison List

Various types of vises, such as VC-N type just fit to No. 30 machines, VE-N type which deeply and firmly grips work, VQX-N type with a high clamping force, etc., are available to accommodate various kinds of work.

In addition, the guide block can be changed to suit the machine where the vise is mounted. In this case, please contact us.



(Unit : mm)

Model	Notice page	Jaw width	Jaw height	Jaw stroke	Total height	Work mounting face height	Full width	Full length	Max. clamping force (kN)	Mass
VC103N 	P.7	100	40	128	105	65	109	355.5	20	16
VC104N 	P.7	100	40	204	105	65	112	431.5	20	19
VE100N 	P.9	100	40	128	115	75	109	355	25	19
VQX100N 	P.13	99.5	35	128	120	85	107	351.5	30	19
VM100N 	P.16	99.5	35	137	120	85	101	351.5	30	19



(Unit : mm)

Model	Notice page	Jaw width	Jaw height	Jaw stroke	Total height	Work mounting face height	Full width	Full length	Max. clamping force (kN)	Mass
VE125N 	P.9	125	50	204	135	85	135	455	30	35
VE125N-15 	P.15	125	50	204	135	85	135	455	30	35
VE125LN 	P.11	125	50	256	135	85	138	510	30	38
VE125LWN 	P.11	125	50	405	135	85	144	680	30	48
VQX125N 	P.13	124.5	40	205	140	100	135	451.5	40	35
VQX125N-15 	P.15	124.5	40	205	140	100	135	451.5	40	35
VM125N 	P.16	124.5	40	214	140	100	126	451.5	40	34
VQA125N 	P.19	124.5	40	195	140	100	150	616	40	45

(Unit : mm)

Model	Notice page	Jaw width	Jaw height	Jaw stroke	Total height	Work mounting face height	Full width	Full length	Max. clamping force (kN)	Mass
VE160N 	P.9	160	60	274	160	100	170	555	45	62
VE160LN 	P.11	160	60	354	160	100	173	635	45	69
VQX160N 	P.13	159.5	45	275	165	120	170	553.5	60	62

(Unit : mm)

Model	Notice page	Jaw width	Jaw height	Jaw stroke	Total height	Work mounting face height	Full width	Full length	Max. clamping force (kN)	Mass
VE200N 	P.9	200	70	303	180	110	214	605	45	95
VE200LN 	P.11	200	70	405	180	110	217	710	45	108
VQX200N 	P.13	200	55	300	190	135	211	605	70	100

(Unit : mm)



VISE

Vises for Small-Size Machines

VC-N series VC103N·VC104N

Blue body vise just fit to small-size machines!

- Just fit to No. 30 class small-size machines
- High-rigidity steel body
- Low-height body adopted, offering a wide machining area
- Aluminum jaws provided as standard
Several kinds of and soft work can be gripped optimally by forming.
- Largest jaw opening
Large work can be gripped with the compact body.
- Stable clamping force secured by the mechanical-type enhancement toggle mechanism
- Minimum lift-up, offering the stable machining accuracy
- Standard parallel specification
Suitable for long-size work and simultaneous machining of multiple workpieces



Top Jaw Dimension Table

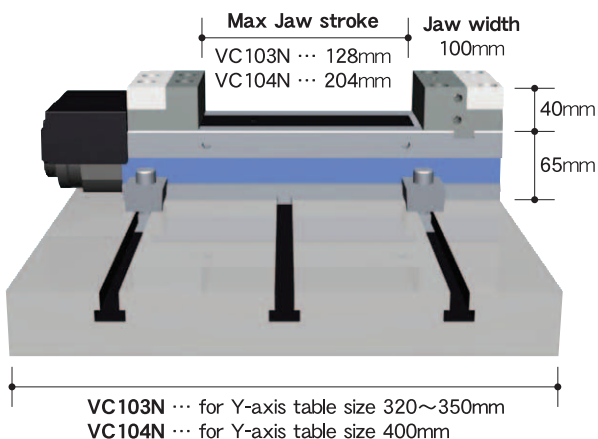

Aluminum Jaws Application

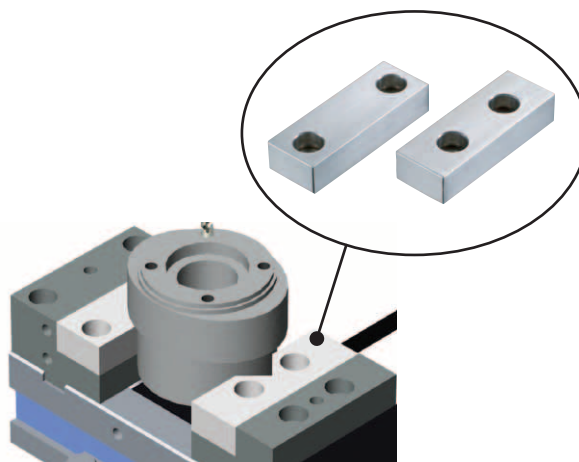

Operating Examples



The standard parallel specification enables machining of long-size work with stable accuracy.



The standard parallel specification enables simultaneous machining of multiple workpieces, thus saving costs.

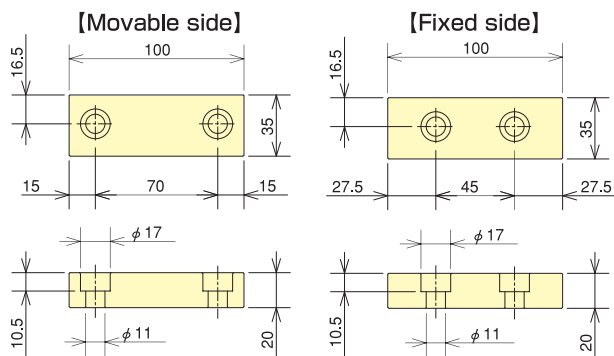

- **Body Material** : Hardened steel ■ **Jaw Material** : Hardened steel
- **Standard Accessories** : Clamp device assembly (clamp device, T-nut(s), bolt(s), washer(s)), handle, L-shaped hexagonal wrench, C-caps, slide cover
- **Options** : Parallel clamp device, stepped guide block, ratchet handle, extension bar, soft jaws (a set of a moving-side and a fixed-side jaws).

※The guide block can be changed to suit the machine where the vise is mounted. In this case, please contact us.

Clamping Force Table

(Unit : kN)

Range	3	2	1	0
Model VC103N	20	15	10	8
Model VC104N				

※Zero range means clamp without a step-up mechanism.
Clamp force shows an allowable amount.

Size Table

(Unit : mm)

Model	A	B	C	D	E	F	G	H	J
VC103N	355.5	160	195.5	273	86	113	105	128	109
VC104N	431.5	200	231.5	349	126	149	181	204	112

Specifications

(Unit : mm)

Model	Jaw width	Jaw height	Jaw stroke	Total height	Work mounting face height	Full width	Full length	Max. clamping force (kN)	Mass (kg)
VC103N	100	40	128	105	65	109	355.5	20	16
VC104N	100	40	204	105	65	112	431.5	20	19

◎Just fit VISES combination with these machines.

Please refer to KITAGAWA's individual manufacturer catalogue in details.





WISE

Lowest profile Type Steel Vises

VE-N series

VE100N·VE125N
VE160N·VE200N

Wide Space machining created Low-Height Steel Vises with the Yellow Body

- High-rigidity steel body
- Ultra-low height type adopted, offering the maximum machining area
- Firm gripping of work ensured by the high jaws
- Stable clamping force ensured by the mechanical-type enhancement toggle mechanism
- Lift-up reduced to the minimum, offering stable machining accuracy
- Standard parallel specification
Suitable for long-size work and simultaneous machining of multiple workpieces



Operating Examples



▲ With the compact body, a KITAGAWA chuck, etc. can be mounted on a parallel, which makes this vise suitable for high-mix low-volume production.

- **Body Material** : Hardened steel ■ **Jaw Material** : Hardened steel
- **Standard Accessories** : Clamp device assembly (clamp device, T-nut(s), bolt(s), washer(s)), handle, L-shaped hexagonal wrench, C-caps, slide cover
- **Options** : Parallel clamp device, stepped guide block, ratchet handle, extension bar, soft jaws (a set of a moving-side and a fixed-side jaws)

※ The guide block can be changed to suit the machine where the vise is mounted. In this case, please contact us.

VE-N

■ Dimensions

■ Clamping Force Table

(Unit : kN)

Range	3	2	1	0
VE100N	25	17	9	8
VE125N	30	21	12	8
VE160N	45	32	20	10
VE200N	45	32	20	10

※Zero range means clamp without a step-up mechanism.
Clamp force shows an allowable amount.

■ Specifications

(Unit : mm)

Model	Model	Jaw height	Jaw stroke	Total height	Work mounting face height	Full width	Full length	Max. clamping force (kN)	Mass (kg)
VE100N	100	40	128	115	75	109	355	25	19
VE125N	125	50	204	135	85	135	455	30	35
VE160N	160	60	274	160	100	170	555	45	62
VE200N	200	70	303	180	110	214	605	45	95

■ Size Table

(Unit : mm)

Model	A	B	C	D	E	F	G	H	J	K	L	M	N	P	Q	R	S	T	U
VE100N	355	112.5	242.5	273	82	38.5	160.5	14	115	75	40	73	64	128	43	180	30	72	103
VE125N	455	145	310	370	85	60	225	18	135	85	50	84	76	204	50	180	30	72	126
VE160N	555	145	410	460	95	50	315	18	160	100	60	94	86	274	65	225	37	95	161
VE200N	605	177	428	510	95	74	333	18	180	110	70	102	98	303	75	225	37	95	202

Model	V	W	X	Y	a	d	e	f	g	h	j	m	n	r	a1	c1	d1	e1	f1
VE100N	100	109	15	5	M8	90	105	15	36.5	40	70	50	40	10	M12×45	60	14~26	22.5	35
VE125N	125	135	21	6	M10	75	220	44	42	50	80	55	50	10	M16×65	72	15~31	30	45
VE160N	160	170	21	6	M10	85	290	51.5	47	80	100	55	50	15	M16×65	72	15~31	30	45
VE200N	200	214	21	7	M10	115	280	57.5	51	100	150	70	60	15	M16×65	72	15~31	30	45



VISE

Lowest profile Type/Lowest profile Type Longest Steel Vises

VE-LN series

VE125LN·VE160LN·VE200LN

VE125LWN

Large jaw opening is offered by the reliable VE-N series! Low height steel vises with the Yellow body

- **High-rigidity steel body**
- **Ultra-low height body** offering the maximum machining area
- **Firm gripping of work** secured by the high jaws
- **Largest jaw opening** in products of the same class
Large work can be gripped with the compact body.
- **Stable clamping force** secured by the mechanical-type enhancement toggle mechanism
- **Lift-up reduced to the minimum**, offering stable machining accuracy
- **Standard parallel specification**
Suitable for long-size work and simultaneous machining of multiple workpieces

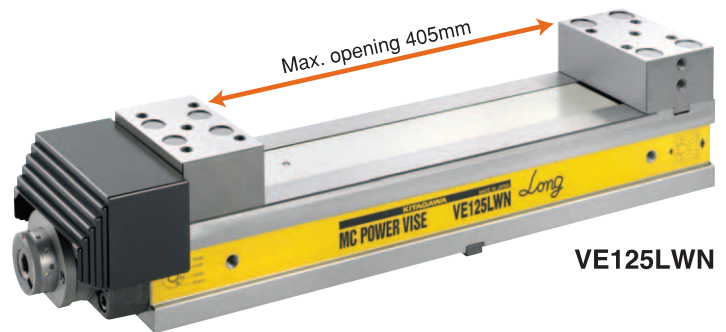

Operating Examples

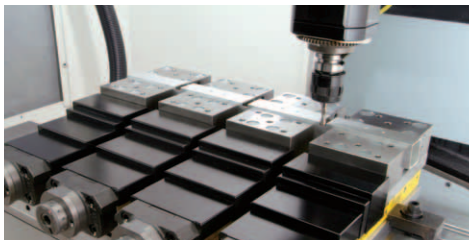

▲ The standard parallel specification enables machining of long-size work with stable accuracy.



▲ The standard parallel specification enables simultaneous machining of multiple workpieces, thus reducing costs.



▲ Large work can be gripped with the compact body.

- **Body Material** : Hardened steel
- **Jaw Material** : Hardened steel
- **Standard Accessories** : Clamp device assembly (clamp device, T-nut(s), bolt(s), washer(s)), handle, L-shaped hexagonal wrench, C-caps, slide cover
- **Options** : Parallel clamp device, stepped guide block, ratchet handle, extension bar, soft jaws (a set of a moving-side and a fixed-side jaws)

※ The guide block can be changed to suit the machine where the vise is mounted. In this case, please contact us.

■ Dimensions

■ Clamping Force Table (Unit: kN)

Model	Range	3	2	1	0
VE125LN		30	21	12	8
VE160LN		45	32	20	10
VE200LN		45	32	20	10
VE125LWN		30	21	12	8

※ Zero range means clamp without a step-up mechanism.
Clamp force shows an allowable amount.

■ Specifications

(Unit: mm)

Model	Jaw width	Jaw height	Jaw stroke	Total height	Work mounting face height	Full width	Full length	Max. clamping force (kN)	Mass (kg)
VE125LN	125	50	256	135	85	138	510	30	38
VE160LN	160	60	354	160	100	173	635	45	69
VE200LN	200	70	405	180	110	217	710	45	108
VE125LWN	125	50	405	135	85	144	680	30	48

■ Size Table

(Unit: mm)

Model	A	B	C	D	E	F	G	H	J	K	L	M	N	P	Q	R	S	T	U
VE125LN	510	200	310	425	85	115	225	18	135	85	50	84	76	256	50	180	30	72	126
VE160LN	635	177	458	540	95	82	363	18	160	100	60	94	86	354	65	225	37	95	161
VE200LN	710	177	533	615	95	74	438	18	180	110	70	102	98	405	75	225	37	95	202
VE125LWN	680	280	400	595	85	195	315	18	135	85	50	84	76	405	50	180	30	72	126

Model	V	W	X	Y	a	d	e	f	g	h	j	m	n	r	a1	c1	d1	e1	f1
VE125LN	125	138	21	6	M10	75	275	44	42	50	80	55	50	10	M16×65	72	15~31	30	45
VE160LN	160	173	21	6	M10	85	370	51.5	47	80	100	55	50	15	M16×65	72	15~31	30	45
VE200LN	200	217	21	7	M10	115	385	57.5	51	100	150	70	60	15	M16×65	72	15~31	30	45
VE125LWN	125	144	21	6	M10	75	445	44	42	50	80	55	50	10	M16×65	72	22~31	30	45



VISE

MC Power Vise VQX-N series

VQX100N·VQX125N
VQX160N·VQX200N

Everlasting standard! MC vises with the Orange body

- Cast iron body with a high vibration damping property
- Firm clamping of work ensured by a high clamping force
- Stable clamping force ensured by the mechanical-type enhancement toggle mechanism
- Lift-up reduced to the minimum, offering stable machining accuracy
- Standard parallel specification
Suitable for long-size work and simultaneous machining of multiple workpieces

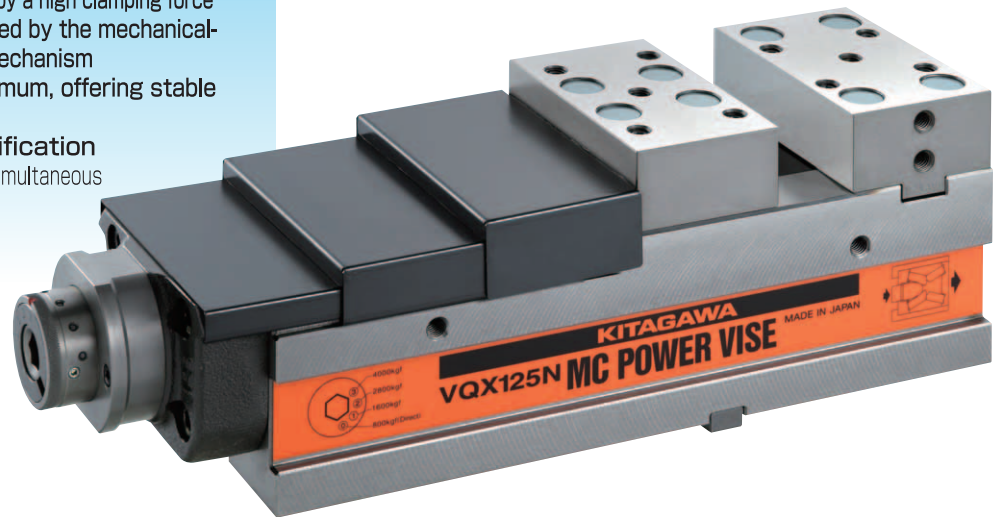

Operating Examples

[By courtesy of Azuma-Japan, Inc.]



▲ On the 3 m linear table, 10 vises are mounted with the parallel specification.

<http://www.azuma-japan.co.jp/>

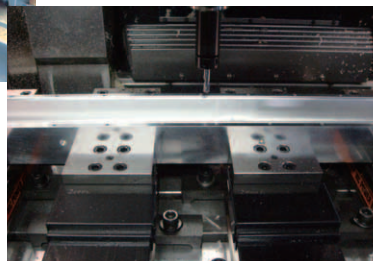

▲ Minimum lift-up ensures stable machining accuracy.



▲ Long-size precision equipment parts are machined.

- **Body Material** : Cast iron ■ **Jaw Material** : Hardened steel
- **Standard Accessories** : Clamp device assembly (clamp device, T-nut(s), bolt(s), washer(s)), handle, L-shaped hexagonal wrench, C-caps, slide cover
- **Options** : Parallel clamp device, stepped guide block, ratchet handle, extension bar, soft jaws (a set of a moving-side and a fixed-side jaws)

※ The guide block can be changed to suit the machine where the vise is mounted. In this case, please contact us.

■ Dimensions

Clamping Force Table (Unit: kN)

Model	Range	4	3	2	1	0
VQX 100N	—	30	21	12	8	—
VQX 125N	—	40	28	16	8	—
VQX 160N	60	46	32	18	10	—
VQX 200N	70	54	38	22	10	—

※Zero range means clamp without a step-up mechanism.
Clamp force shows an allowable amount.

■ Specifications

(Unit: mm)

Model	Jaw width	Jaw height	Jaw stroke	Total height	Work mounting face height	Full width	Full length	Max. clamping force kN	Mass (kg)
VQX 100N	99.5	35	128	120	85	107	351.5	30	19
VQX 125N	124.5	40	205	140	100	135	451.5	40	35
VQX 160N	159.5	45	275	165	120	170	553.5	60	62
VQX 200N	200	55	300	190	135	211	605	70	100

■ Size Table

(Unit: mm)

Model	A	B	C	D	E	F	G	H	J	K	L	M	N	P	Q	R	S	T	U	V
VQX 100N	351.5	112.5	239	273	78.5	38.5	160.5	14	120	85	35	73	64	128	53	180	30	72	101	99.5
VQX 125N	451.5	145	306.5	365	86.5	66	220	18	139.5	100	39.5	78	74	205	65	180	30	72	126	124.5
VQX 160N	553.5	145	408.5	455	98.5	58	310	18	165	120	45	86	86	275	78	225	37	95	161	159.5
VQX 200N	605	177	428	505	100	75	328	18	190	135	55	100	97	300	93	225	37	95	202	200

Model	W	X	Y	a	d	e	f	g	h	j	m	n	r	t	y	a1	c1	d1	e1	f1
VQX 100N	107	15	5.5	M 8	90	105	25	36.5	40	70	50	40	10	1	7	M12×45	59.5	14~26	22.5	35
VQX 125N	135	21	7	M10	75	215	27	39	50	80	55	50	10	1	10	M16×65	71	15~31	30	45
VQX 160N	170	21	7	M10	85	285	37	43	80	100	55	50	15	1	10	M16×65	71	15~31	30	45
VQX 200N	211	21	7	M10	115	275	50	50	100	150	70	60	15	2	10	M16×65	71	15~31	30	45



VISE

Power Vises for Centre Groove Tables

VE125N-15 · VQX125N-15

Problem with key grooves...?? Use the centre guide block vises!

- Guide block just fit to centre groove tables
- Stable clamping force ensured by the mechanical-type enhancement toggle mechanism
- Lift-up reduced to the minimum, offering stable machining accuracy
- Standard parallel specification

Suitable for long-size work and simultaneous machining of multiple workpieces

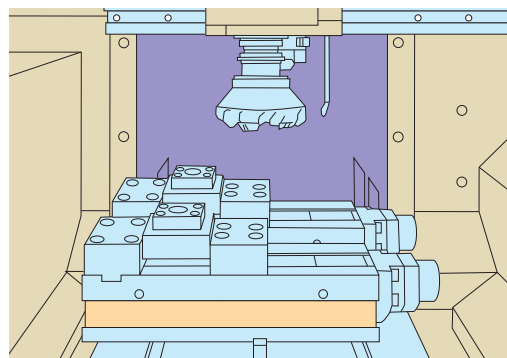

■ Dimensions

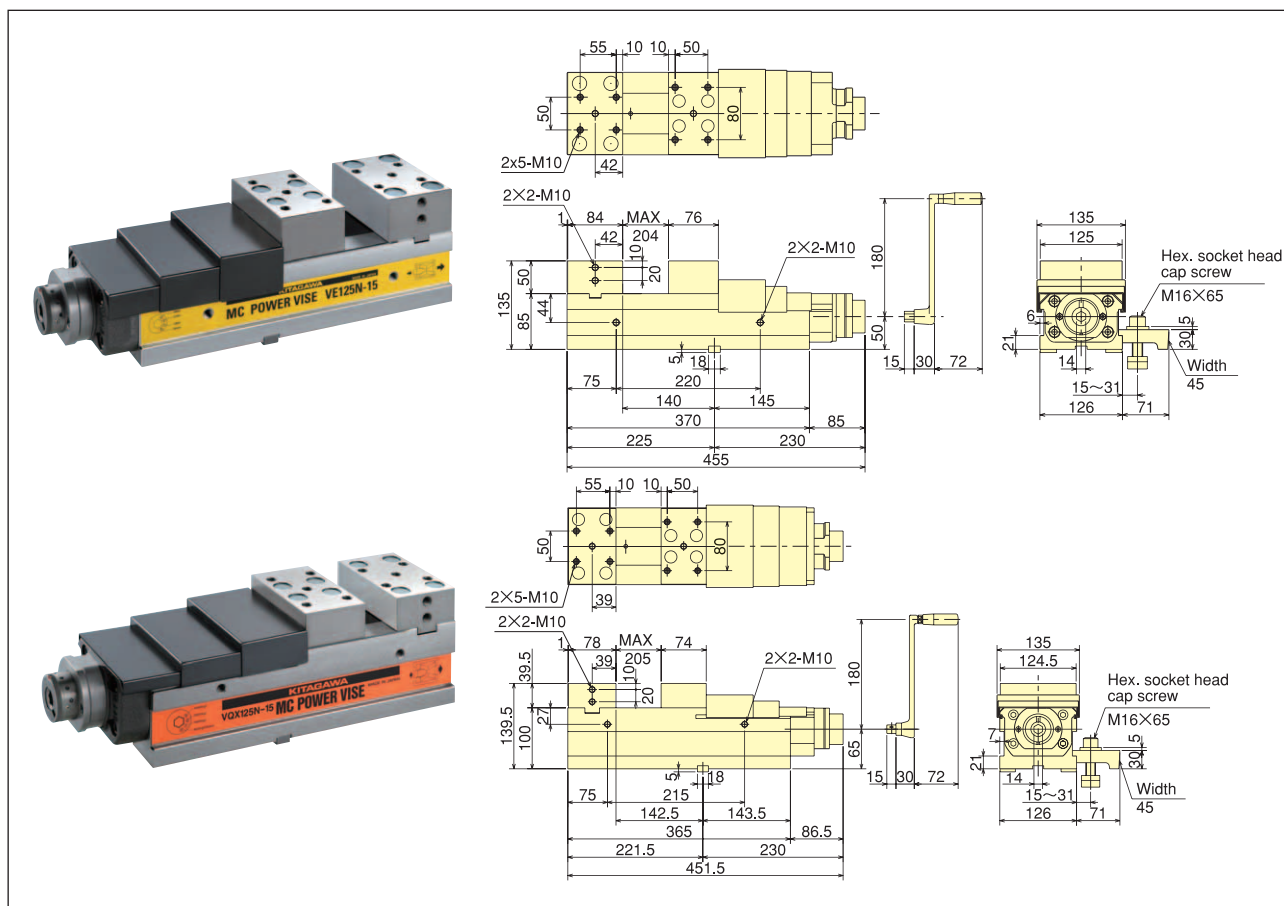

■ Clamping Force Table (Unit : kN)

Range	3	2	1	0
VE125N-15	30	21	12	8
VQX125N-15	40	28	16	8

* Zero range means clamp without a step-up mechanism.
Clamp force shows an allowable amount.

■ Specifications

(Unit : mm)

Model	Jaw width	Jaw height	Jaw stroke	Total height	Work mounting face height	Full width	Full length	Max. clamping force(kN)	Mass (kg)
VE125N-15	125	50	204	135	85	135	455	30	35
VQX125N-15	124.5	40	205	140	100	135	451.5	40	35

- **Body Material** : VE125N-15 Hardened steel, VQX125N-15 cast iron
- **Jaw Material** : Hardened steel
- **Standard Accessories** : Clamp device assembly (clamp device, T-nut(s), bolt(s), washer(s)), handle, L-shaped hexagonal wrench, C-caps, slide cover
- **Options** : Parallel clamp device, stepped guide block, ratchet handle, extension bar, soft jaws (a set of a moving-side and a fixed-side jaws)

※ The guide block can be changed to suit the machine where the vise is mounted. In this case, please contact us.



WISE

MC Power Vise Multi-type VM-N series

The new system enables vertical and horizontal mounting, and clamping of the inside of work!
Versatile Vises with the Green Body

- Vertical and horizontal mounting, and inside clamping enabled
Can be mounted in various directions according to the work type.
- Cast iron body with a high vibration damping property
- Firm clamping of work ensured by a high clamping force
- Stable clamping force ensured by the mechanical-type enhancement toggle mechanism
- Lift-up reduced to the minimum, offering stable machining accuracy
- Standard parallel specification
Suitable for long-size work and simultaneous machining of multiple workpieces
The VQX-N type can be used on a parallel.

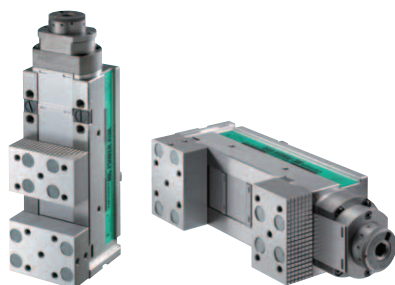
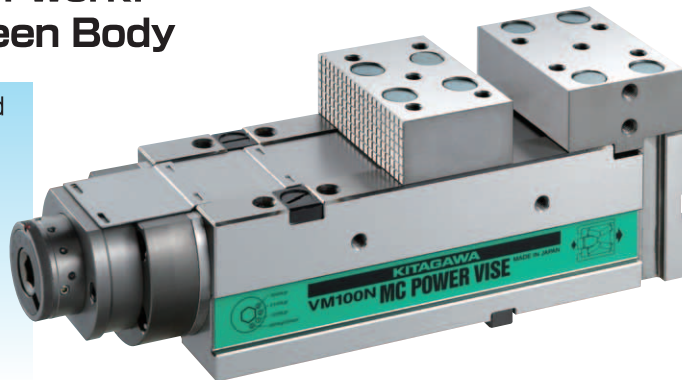

[Vertical Mounting] [Side Mounting]

Dimensions

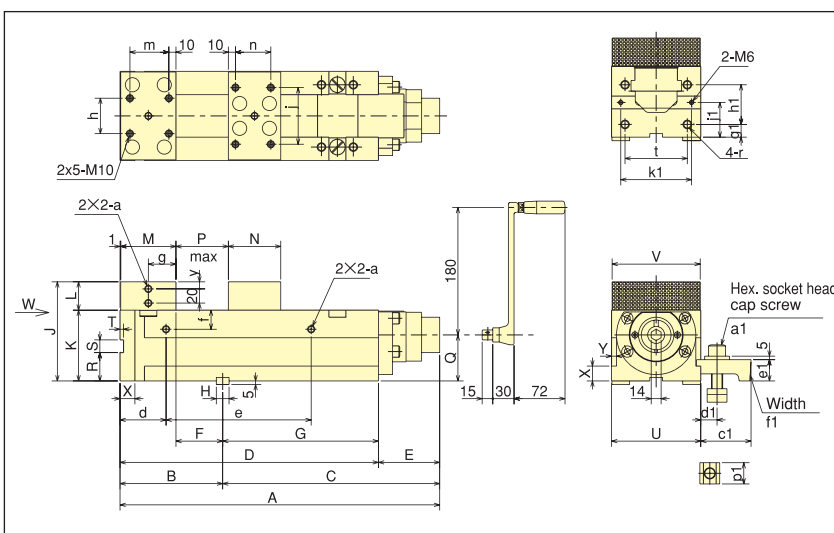

Clamping Force Table (Unit : kN)

Range	3	2	1	0
VM100N	30	21	12	8
VM125N	40	28	16	8

*Zero range means clamp without a step-up mechanism.
Clamp force shows an allowable amount.

Specifications

(Unit : mm)

Model	Jaw width	Jaw height	Jaw stroke	Total height	Work mounting face height	Full width	Full length	Max. clamping force (kN)	Mass (kg)
VM100N	99.5	35	137	120	85	101	351.5	30	19
VM125N	124.5	40	214	140	100	126	451.5	40	34

Size Table

Model	A	B	C	D	E	F	G	H	J	K	L	M	N	P	Q	R	S	T	U	V	X	Y
VM100N	351.5	112.5	239	273	78.5	38.5	160.5	14	120	85	35	73	64	137	53	35	14	4	101	99.5	15	5.5
VM125N	451.5	145	306.5	365	86.5	66	220	18	139.5	100	39.5	78	74	214	65	40	18	5	126	124.5	21	7

Model	a	d	e	f	g	h	j	m	n	r	t	y	a1	c1	d1	e1	f1	g1	h1	J1	k1
VM100N	M8	90	105	25	36.5	40	70	55	40	M10	76	7	M12×45	60	14~26	22.5	35	15	55	42	81
VM125N	M10	75	195	27	39	50	80	50	50	M12	88	10	M16×65	72	15~31	30	45	18	56	49	100

■ Body Material : Cast iron ■ Jaw Material : Hardened steel

■ Standard Accessories : Clamp device assembly (clamp device, T-nut(s), bolt(s), washer(s)), handle, L-shaped hexagonal wrench, C-caps, slide cover

■ Options : Parallel clamp device, stepped guide block, ratchet handle, extension bar, soft jaws (a set of a moving-side and a fixed-side jaws)

*The guide block groove can be changed so that it is suitable for the machine where the vise is mounted. In this case, please contact us.

VM-N

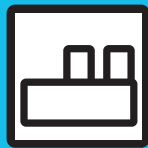

VISE

Multi-Power Vise Vertical 4-Piece Integrated Type MV125N

The most suitable for horizontal machines! Vertical integrated-type vise without an angle plate

- Costs saved by elimination of an angle plate
- Firm clamping of work ensured by a high clamping force
- Cast iron body with a high vibration damping property
- Stable clamping force ensured by the mechanical -type enhancement toggle mechanism
- High rigidity achieved by the integrated body
- Lift-up reduced to the minimum, offering stable machining accuracy



Dimensions

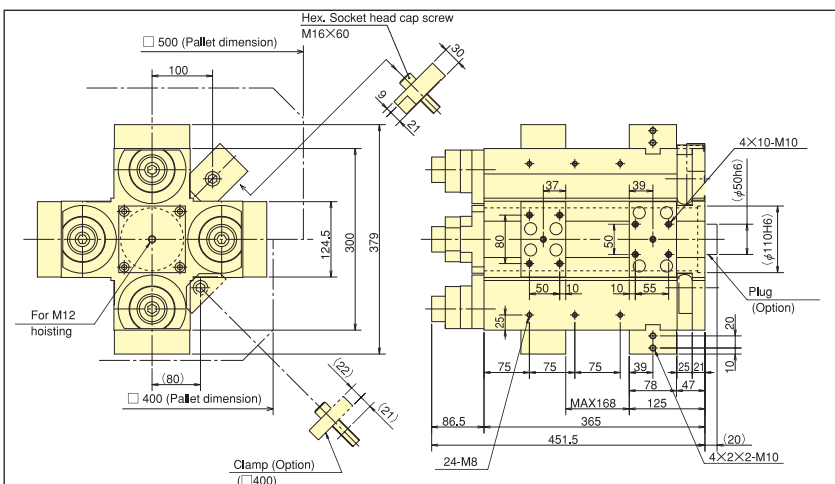

Clamping Force Table (Unit : kN)

Range	3	2	1	0
MV125N	40	28	16	8

*Zero range means clamp without a step-up mechanism. Clamp force shows an allowable amount.

Specifications

(Unit : mm)

Model	Jaw width	Jaw stroke	Total height	Full width	Max. clamping force(kN)	Mass (kg)
MV125N	124.5	168	451.5	379	40	150

Jaw allowable sizes for clamping force

(Unit : mm)

MV125N	Range	3	2	1
	Jaw height	40 (standard)	60	100

Dynamic accuracy

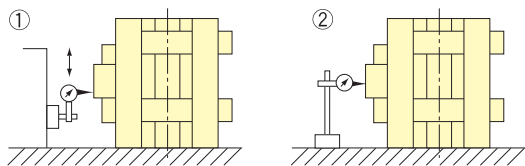

(Unit : mm)

No.	Inspection item	Tolerance
1	Parallelism of upper face of clamped test block and jaw slideway	0.015 per 100
2	Upper face lift of test block when clamped	0.015

Static accuracy

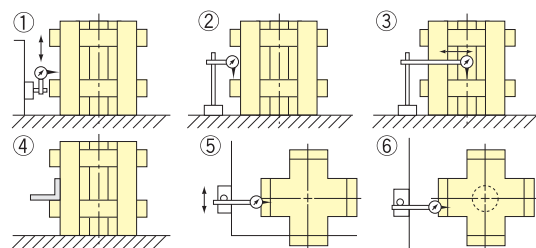

(Unit : mm)

No.	Inspection item	Tolerance
1	Squareness of vise body bottom face and jaw slideway	0.015 per 150
2	Mutual difference of height from body bottom face fixed jaw clamping face	Measured 0.020 at jaw center.
3	Parallelism of body bottom face and fixed jaw clamping face	0.010 for total overall jaw width
4	Squareness of jaw slideway and fixed jaw clamping face	0.010 for total jaw height Not to be outside opening
5	Squareness of jaw slideway	0.015
6	Distance difference from body centre to each jaw slideway	0.040

- Body Material : Cast iron
 - Jaw Material : Hardened steel
 - Standard Accessories : Clamp device assembly (clamp device, bolt(s)), handle, L-shaped hexagonal wrench, C-caps, slide cover
 - Options : Clamp device □400, ratchet handle, extension bar, soft jaws (a set of a moving-side and a fixed-side jaws), plug
- ※For the soft jaw on the fixed side, a customerm shall machine it additionally after purchasing. (See page 21.)



VISE

Multi-Power Vise Horizontal 4-Piece Integrated Type MH125N-4

**Most suitable for high-volume production machining!
Parallel integrated-type vise**

- Most suitable for long-size work and simultaneous machining of multiple workpieces
- Cast iron body with a high vibration damping property
- High rigidity ensured by the integrated body
- Firm clamping of work ensured by a high clamping force
- Stable clamping force ensured by the mechanical-type enhancement toggle mechanism
- Lift-up reduced to the minimum, offering stable machining accuracy
- The VQX-N type jaws can be used.

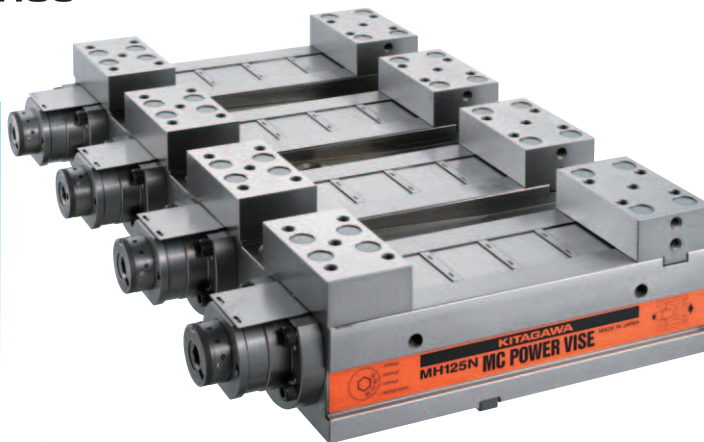

Clamping Force Table (Unit : kN)

Range	3	2	1	0
MH125N-4	40	28	16	8

※ Zero range means clamp without a step-up mechanism.
Clamp force shows an allowable amount.

Specifications (Unit : mm)

Jaw width	Jaw stroke height	Total width	Full width	Max. clamping force(kN)	Mass (kg)
124.5	205	140	650	40	170

Jaw allowable sizes for clamping force (Unit : mm)

MH125N-4	Range	3	2	1
	Jaw height	40 (standard)	60	100

Dimensions

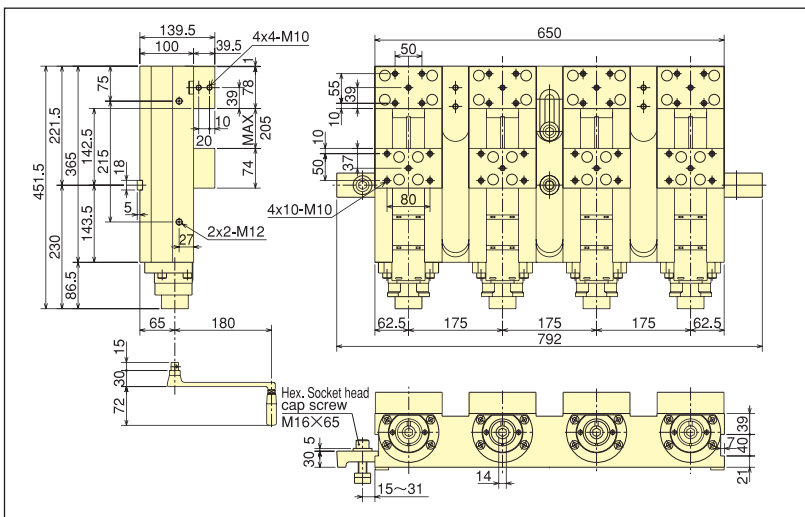

(Unit : mm)

Dynamic accuracy

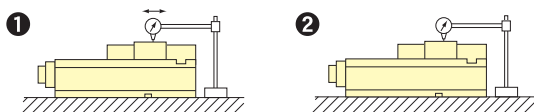

No.	Inspection item	Tolerance
1	Parallelism of upper face of clamped test block and body bottom face	0.015 per 100
2	Lift on upper face of test block when clamped.	0.015

(Unit : mm)

Static accuracy

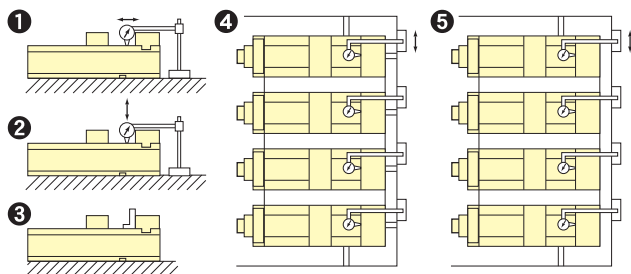

No.	Inspection item	Tolerance
1	Parallelism of body bottom face and jaw slideway	0.010 for max. jaw opening width
2	Height difference for each jaw slideway	Measured at jaw opening width center
3	Squareness of fixed jaw clamping face and jaw slideway	0.010 for total jaw height Not to be outside opening.
4	Difference of come-in/out of fixed jaw clamping face for guide block side face of body bottom face	Measured at jaw width center to 0.010.
5	Parallelism of guide block side face of body bottom face and fixed jaw clamping face	0.010 for overall jaw width

■ **Body Material** : Cast iron ■ **Jaw Material** : Hardened steel

■ **Standard Accessories** : Clamp device assembly (clamp device, T-nut(s), bolt(s), washer(s)), handle, L-shaped hexagonal wrench, C-caps, slide cover

■ **Options** : Stepped guide block, ratchet handle, extension bar, soft jaws (a set of a moving-side and a fixed-side jaws)

※ The guide block can be changed to suit the machine where the vise is mounted. In this case, please contact us.

MH125N-4



WISE

KITAGAWA Vice Accessories

Standard Accessories

■ **Clamp device assembly**
(clamp device, T-nut(s), bolt(s), washer(s))

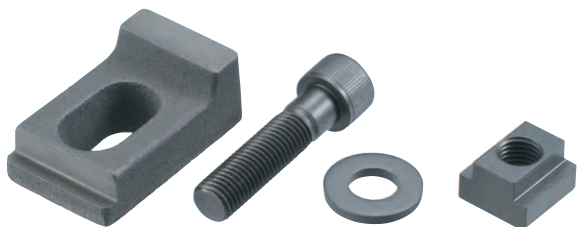

■ **Handle**

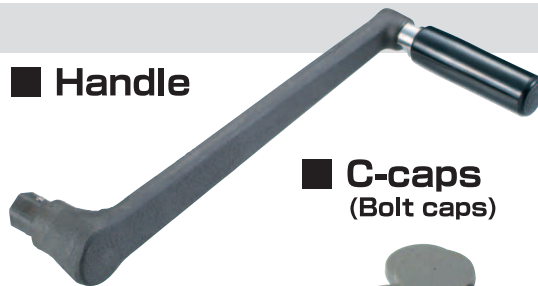

■ **C-caps**
(Bolt caps)



Special Accessories (Option)

■ **Parallel clamp device**

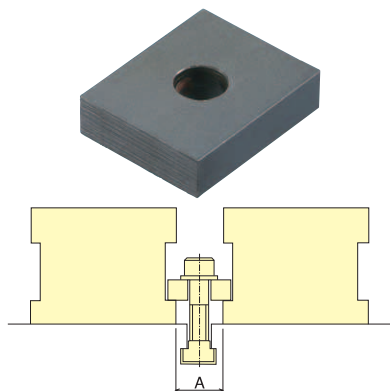

■ **Size Table**

(Unit : mm)

Model	Dimension	A (Space between two bodies)	
		Shortest	While using in longitudinal direction.
VC103N · VC104N · VE100N		29	37
VQX100N · VM100N		28	36
VE125N · VE160N · VE125LN · VE160LN		27	44
VE200N · VE200LN · VQX125N · VQX160N · VQX200N · VM125N		25	42

※In case of VQA125N parallel spec., a special parallel clamping is required.

■ **Stepped guide blocks**

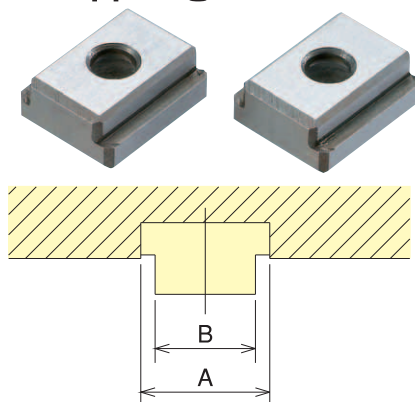

■ **Size Table**

(Unit : mm)

Model	Dimension	A	B
		VC103N · VC104N · VE100N · VQX100N · VM100N	14
VE125N · VE160N · VE200N · VE125LN · VE160LN · VE200LN · VQX125N · VQX160N · VQX200N · VE125N-15 · VQX125N-15 · VM125N · MH125N-4 · VQA125N	18	10 · 12 · 14 · 16 · 20 · 22	

■ **Ratchet handle**



■ **Extension bar**

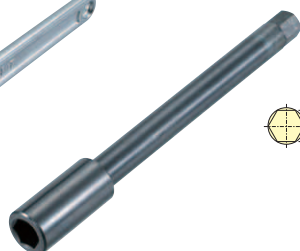

■ **Size Table**

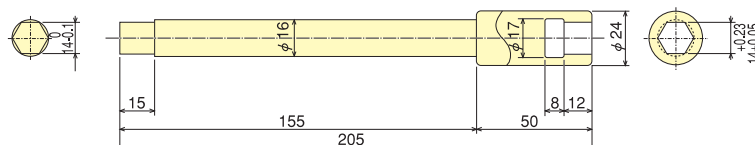

Accessories (Option)



WISE

KITAGAWA Vise Accessories

Options

Soft jaws

The soft jaws matched to the work form can be used.

- ※Material: Steel S45C *Available in a set of 2 pieces (for the fixed side and moving side)
- ※The dimensions of the old-type soft jaws differ.
- ※When the soft jaws are used, parallel accuracy is not guaranteed.



【Movable side】



【Fixed side】

VE-N, VE-LN

【Movable side】

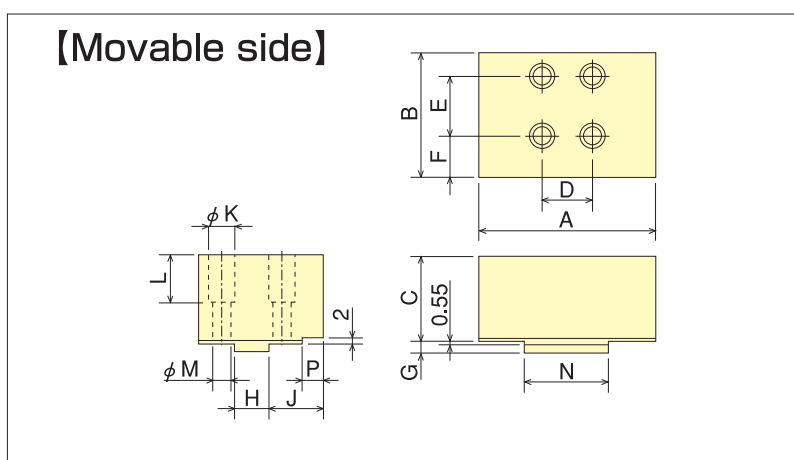

Size Table [Movable side]

(Unit : mm)

Model	A	B	C	D	E	F	G	H	J	K	L	M	N	P
100N, VC-N	100	74	60	37	35	24.5	6.5	18	33	17.5	34.5	11	51.5	10
125N	125	89	70	38	44	29	6.5	18	42	20	37.5	13	59.5	13
160N	160	102	85	56	50	34	8.5	24	47	23	45.5	15	80.5	16
200N	200	118	100	65	60	39	8.5	24	57	26	52.5	17	95	20

【Fixed side】

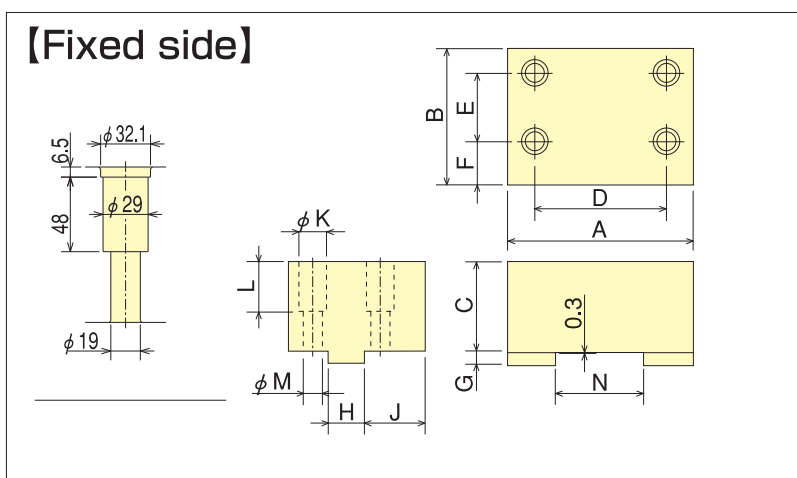

Size Table [Fixed side]

(Unit : mm)

Model	A	B	C	D	E	F	G	H	J	K	L	M	N
100N, VC-N	100	83	60	76	44	24.5	6	18	37.5	17.5	34.5	11	55
125N	125	97	70	92	48	31	6	18	46	23	40.5	15	63
160N	160	110	85	122	54	36	8	24	51	26	47.5	17	84
200N	200	122	100	150	60	41	8	24	59	—	—	—	100

VQX-N, VM-N, MV125N, MH125N

[Movable side]

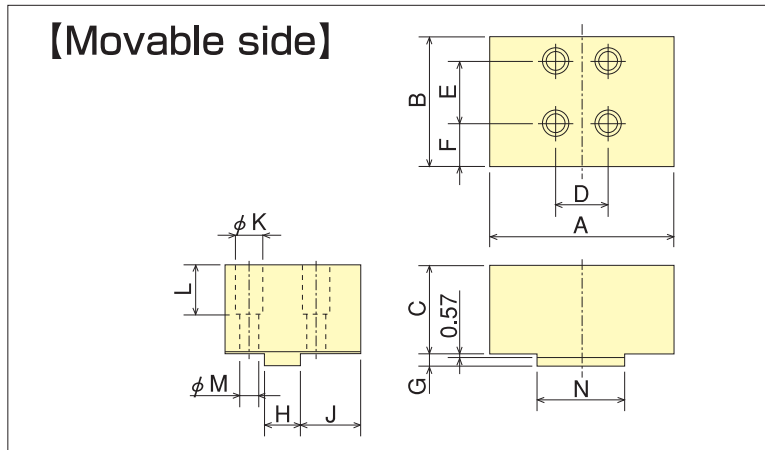

Size Table [Movable side]

(Unit: mm)

Model	A	B	C	D	E	F	G	H	J	K	L	M	N
100N	99.5	74	50	37	35	24.5	6.5	18	33	17.5	29.5	11	51.5
125N	124.5	87	60	35	42	29	8	24	38	20	38	13	59.5
160N	159.5	102	60	56	50	34	9	28	45	23	35.5	15	80.5
200N	200	117	75	62	59	39	9	28	54.5	26	42.5	17	95

[Fixed side]

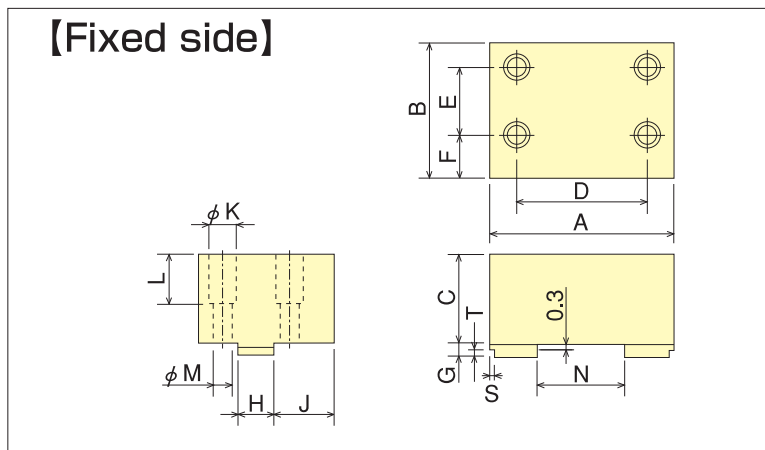

Size Table [Fixed side]

(Unit: mm)

Model	A	B	C	D	E	F	G	H	J	K	L	M	N	S	T
100N	99.5	83	50	76	35	29	6	18	37.5	17.5	29.5	11	55	0	0
125N	124.5	91	60	88	45	29.5	8	24	40	20	38	13	63	6	7.7
160N	159.5	102	60	124	50	34	9	28	45	23	35.5	15	84	—	—
200N	200	122	75	140	62	40	9	28	57	26	42.5	17	100	—	—

※For MV125N, refer to the following exclusive fixed side soft jaws.

Fixed-side soft jaw exclusive for MV-125N

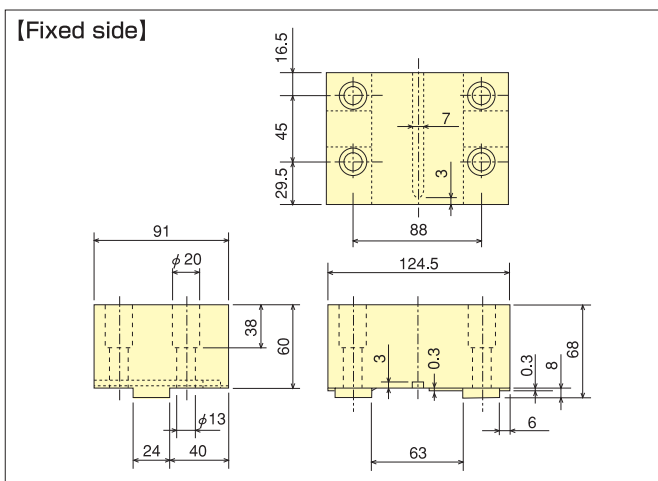

※After purchasing, a customer shall machine it additionally.
 ※For the moving-side soft jaws, see the above information.



CLAMPER

MC Compact Clamper VAX125

VAX125 (One side fixed)

Option Jaws and Clamping Inserts enable to propose new clamping systems.
Mounting on the tilting rotary tables and trunnion assembly is recommended!

VAX125

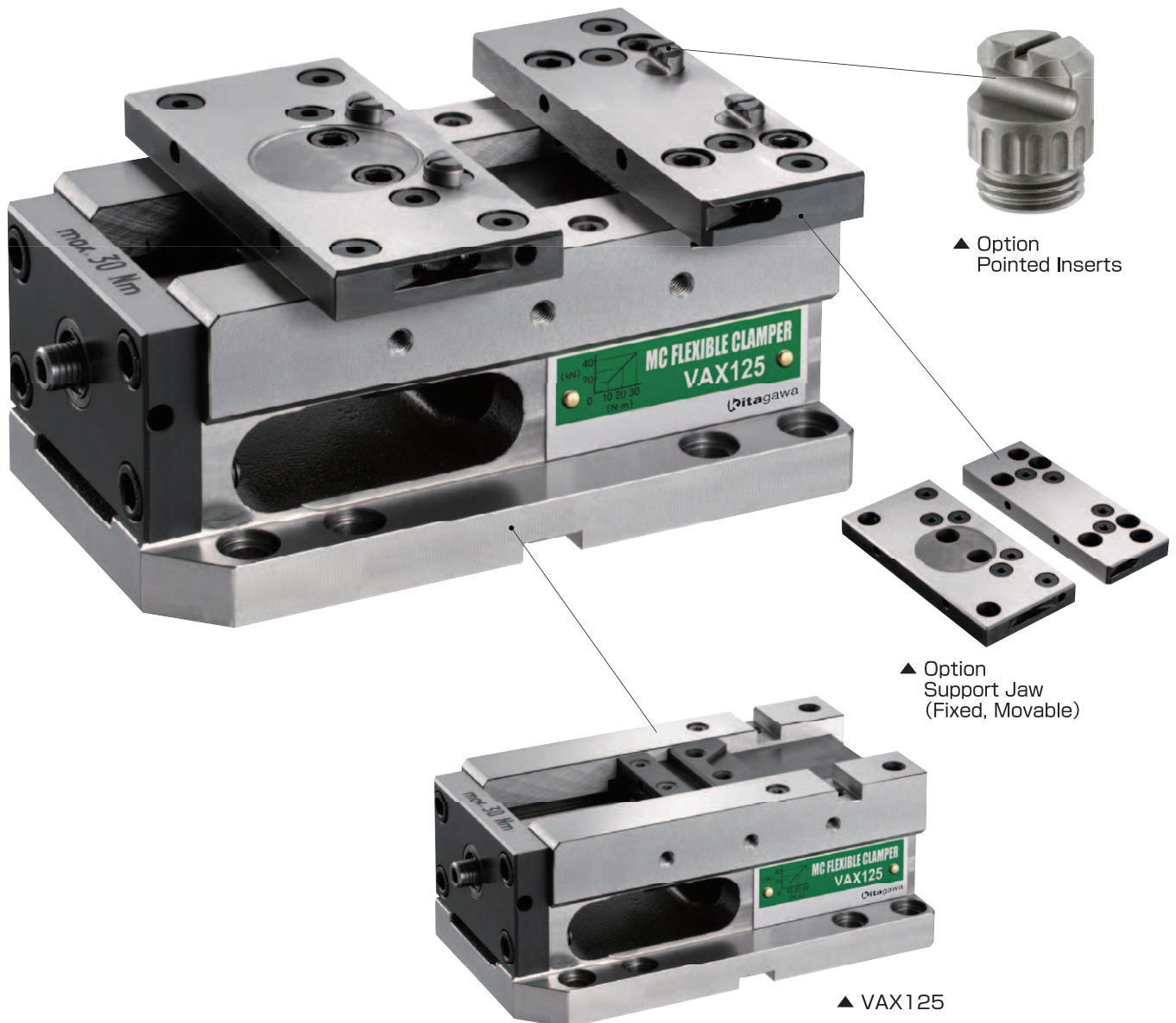

● **Secure and accurate clamping!**

Max. Clamping torque 40kN allows a wide variety of materials to be held.

● **Various Option Jaws and Clamping Inserts are available!**

There are various choices from 3 types of insert and 2 types of integrated jaws etc..

Setting the insert on fixed jaw or movable jaw etc.. enable to accommodate various workpiece.

● **Suitable for various machines!**

The compact clamper with versatile clamping perfectly suit for 5-axis machining center but also vertical and horizontal machining center.

We propose total coordinate for work holdings, mounting on KITAGAWA NCRT etc.

Body Material Standard Accessories

Body Material

Standard Accessories

Casting

■ Mounting Bolt

(M12×35)

*For fixing VAX125 on Machines with 13mm dia. Bolt hole.



■ Torque Wrench



■ Socket Screw Wrench

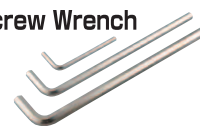

Option

- 9 clamping ways are available by only 1 VAX125 with the combinations of inserts and jaws!
- Optimum clamping way can be found for various workpieces!

Support Jaw (Fixed, Movable) 	64mm Width Jaw (Fixed, Movable) 	Step Jaw (Fixed, Movable) 	Universal Jaw (Fixed, Movable) 	Pointed Insert 	Flat Insert
Round Insert 	Stepped Guide Block (20/14, 20/16, 20/18) 	Clamp Device Assembly (14, 16, 18) 	Universal Clamp Set 	Console 	

※The material of all jaws is hardened steel, ※All the jaw fixed and the jaw movable should be purchased separately, ※The material of all inserts is hardened steel.

Combination Example

■ Pointed Insert Clamping

Pointed Insert x 4 pcs.

Support Jaw (Fixed, Movable)

• Clamping Range

	Min.	Max.
Square Workpiece	 W70mm×L26mm	 W150mm×L184mm
Round Workpiece	 φ 80mm	 φ 226mm

■ Flat Insert Clamping

Flat Insert x 4 pcs.

Support Jaw (Fixed, Movable)

• Clamping Range

	Min.	Max.
Square Workpiece	 W70mm×L30mm	 W150mm×L188mm
Round Workpiece	 φ 82mm	 φ 228mm

■ Round Insert Clamping

Round Insert x 4 pcs.

Support Jaw (Fixed, Movable)

• Clamping Range

	Min.	Max.
Square Workpiece	 W70mm×L18mm	 W150mm×L176mm
Round Workpiece	 φ 76mm	 φ 222mm

64mm Width Jaw Clamping

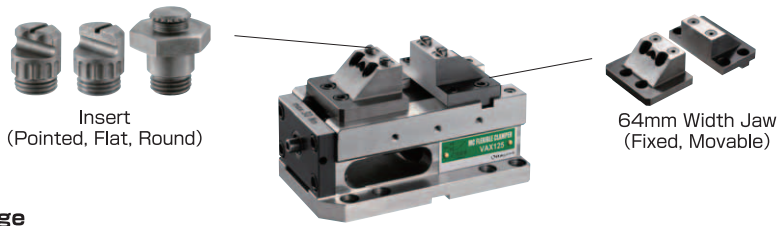

Clamping Range

64mm Width Jaw
(Fixed, Movable)



Min. L0mm
Max. L50mm

64mm Width Jaw (Fixed, Movable) **with Insert** (Pointed, Flat, Round)

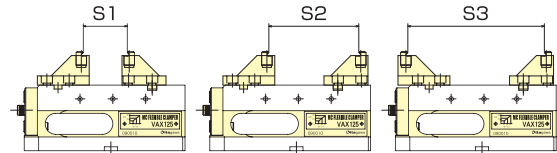
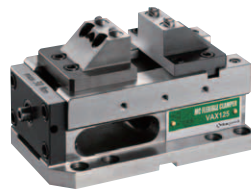

	Width		Length S1		Length S2		Length S3	
	Min.	Max.	Min.	Max.	Min.	Max.	Min.	Max.
Pointed	50mm	19mm	67mm	61mm	137mm	128mm	208mm	
Flat	50mm	23mm	71mm	65mm	141mm	132mm	212mm	
Round	50mm	15mm	59mm	53mm	129mm	120mm	200mm	

Step Jaw Clamping

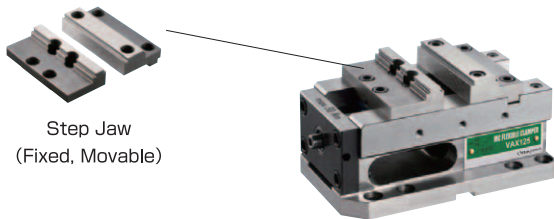

Clamping Range

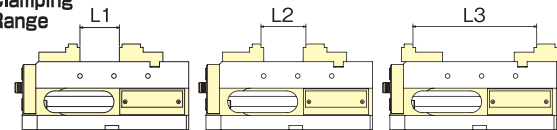

Length L1		Length L2		Length L3	
Min.	Max.	Min.	Max.	Min.	Max.
0mm	58mm	8mm	66mm	77mm	182mm

Universal Clamp Set Clamping

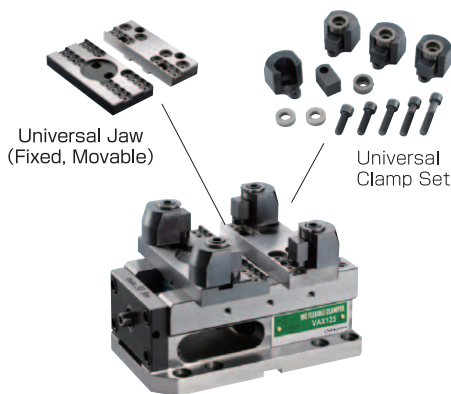

Clamping Range

Square Workpiece

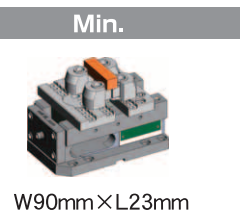

Round Workpiece

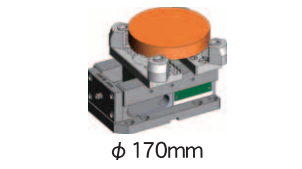
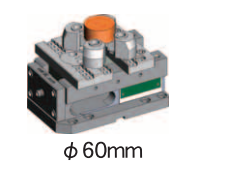

Console



Dimensions

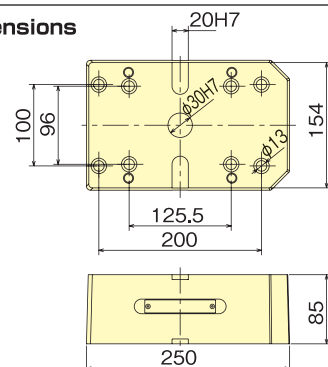

■ Dimensions

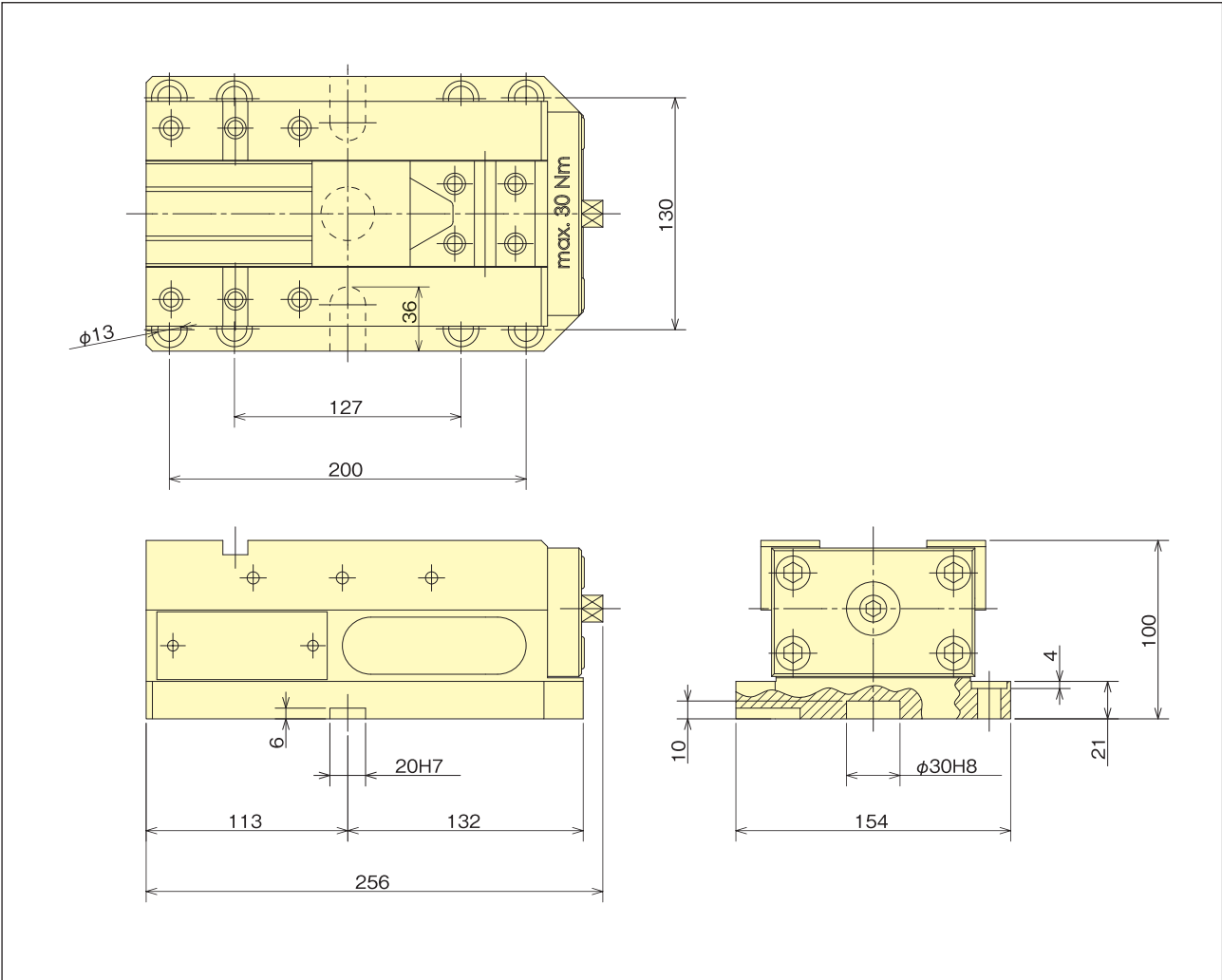

■ Specifications

Model	Total height mm	Full width mm	Full length mm	Max. clamping force kN	Mass kg
VAX125	100	154	256	40	17



CLAMPER

MC Compact Clamper VAX125 VAX125C (Both sides movable)

Improving the accessibility enable to make the ideal condition for machining.
Optional jaws are available to accommodate various workpiece.

VAX125C

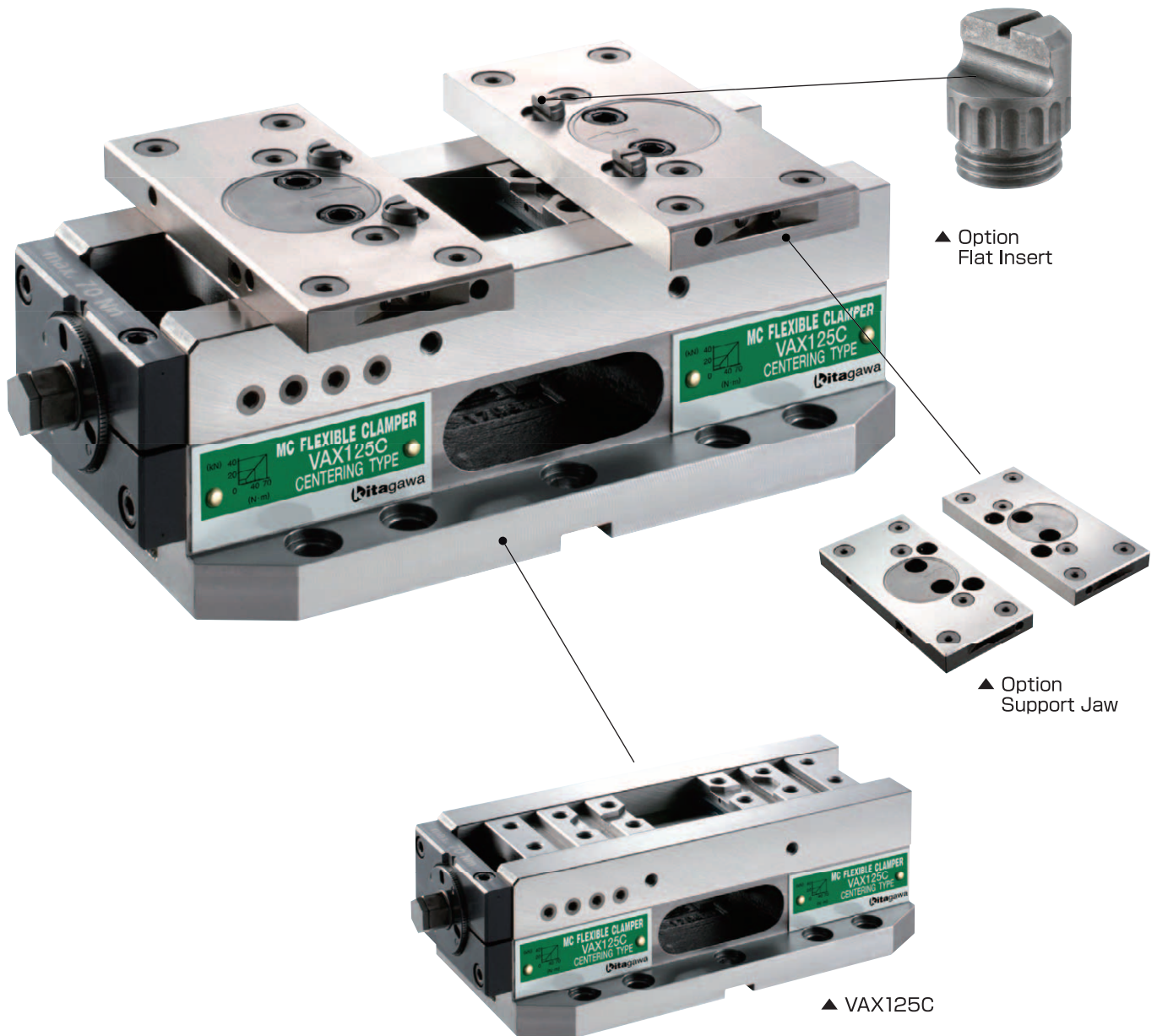

▲ Option Flat Insert

▲ Option Support Jaw

▲ VAX125C

● **Secure and accurate clamping!**

Max. Clamping torque 40kN allows a wide variety of materials to be held.

● **Various Option Jaws and Clamping Inserts are available!**

There are various choices from 3 types of insert and 2 types of integrated jaws etc..

Setting the insert on fixed jaw or movable jaw etc.. enable to accommodate various workpiece.

● **Suitable for various machines!**

The compact clamper with versatile clamping perfectly suit for 5-axis machining center but also vertical and horizontal machining center.

We propose total coordinate for work holdings, mounting on KITAGAWA NCRT etc.

Body Material

Casting

Standard Accessories

■ Mounting Bolt

(M12×35)

*For fixing VAX125C on Machines with 13mm dia. Bolt hole.



■ Torque Wrench



■ Socket Screw Wrench



■ Combination Wrench



Option

- 9 clamping ways are available by only 1 VAX125C with the combinations of inserts and jaws!
- Optimum clamping way can be found for various workpieces!

Support Jaw 	64mm Width Jaw 	Step Jaw 	Universal Jaw 	Pointed Insert 	Flat Insert
Round Insert 	Stepped Guide Block (20/14, 20/16, 20/18) 	Clamp Device Assembly (14, 16, 18) 	Universal Clamp Set 	Console 	

※The material of all jaws is hardened steel. ※All the jaw fixed and the jaw movable should be purchased separately. ※The material of all inserts is hardened steel.

Combination Example

■ Pointed Insert Clamping

Pointed Insert x 4 pcs. Support Jaw

Clamping Range	Min.	Max.
Square Workpiece	 W70mm×L27mm	 W150mm×L242mm
Round Workpiece	 φ 65mm	 φ 274mm

■ Flat Insert Clamping

Flat Insert x 4 pcs. Support Jaw

Clamping Range	Min.	Max.
Square Workpiece	 W70mm×L31mm	 W150mm×L246mm
Round Workpiece	 φ 67mm	 φ 276mm

■ Round Insert Clamping

Round Insert x 4 pcs. Support Jaw

Clamping Range	Min.	Max.
Square Workpiece	 W70mm×L19mm	 W150mm×L234mm
Round Workpiece	 φ 61mm	 φ 270mm

64mm Width Jaw Clamping

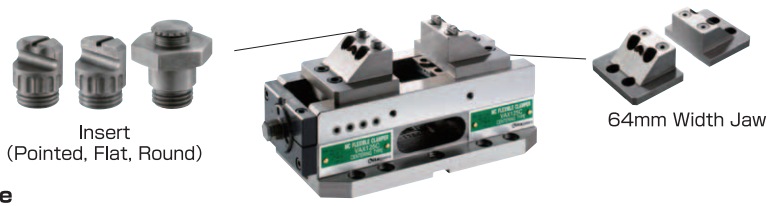

• Clamping Range

64mm Width Jaw



64mm Width Jaw with Insert (Pointed, Flat, Round)

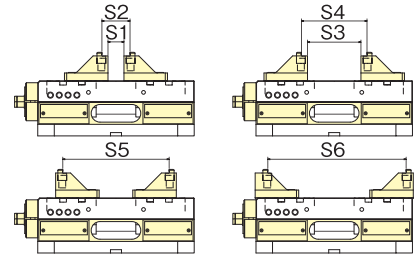

	Width		Length S1		Length S2		Length S3		Length S4		Length S5		Length S6	
	Min.	Max.	Min.	Max.	Min.	Max.	Min.	Max.	Min.	Max.	Min.	Max.	Min.	Max.
Pointed	50mm		21mm	74mm			54mm	142mm	128mm	216mm	196mm	284mm		
Flat	50mm	0mm	59mm	25mm	78mm	35mm	127mm	58mm	146mm	132mm	220mm	200mm	288mm	
Round	50mm			13mm	66mm			46mm	134mm	120mm	208mm	188mm	276mm	

Step Jaw Clamping

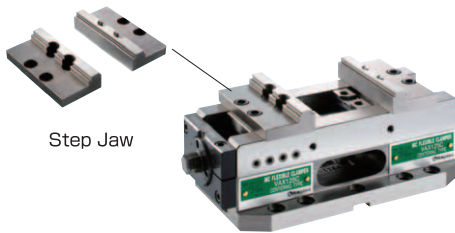

• Clamping Range

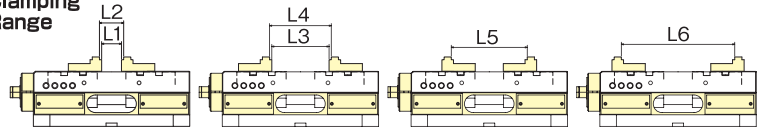

Length L1		Length L2		Length L3		Length L4		Length L5		Length L6	
Min.	Max.	Min.	Max.	Min.	Max.	Min.	Max.	Min.	Max.	Min.	Max.
0mm	85mm	9mm	94mm	90mm	153mm	99mm	162mm	95mm	188mm	163mm	256mm

Universal Clamp Set Clamping

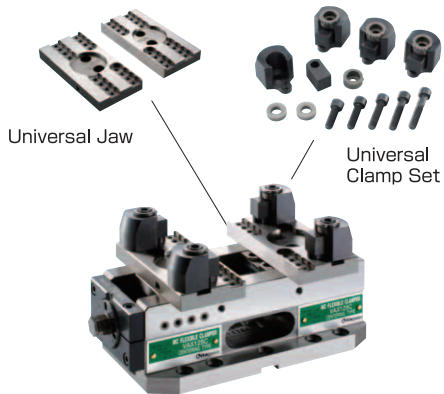

• Clamping Range

Min.	Max.
------	------

Square Workpiece

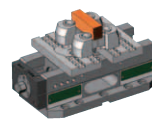

W90mm×L23mm

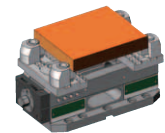

W165mm×L192mm

Round Workpiece



φ 55mm

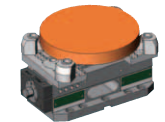

φ 240mm

Console



• Dimensions

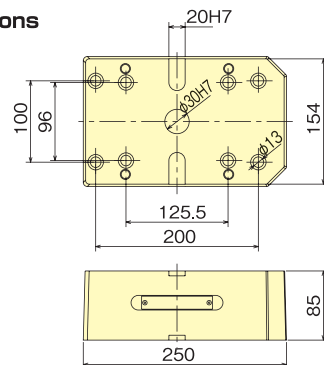

■ Dimensions

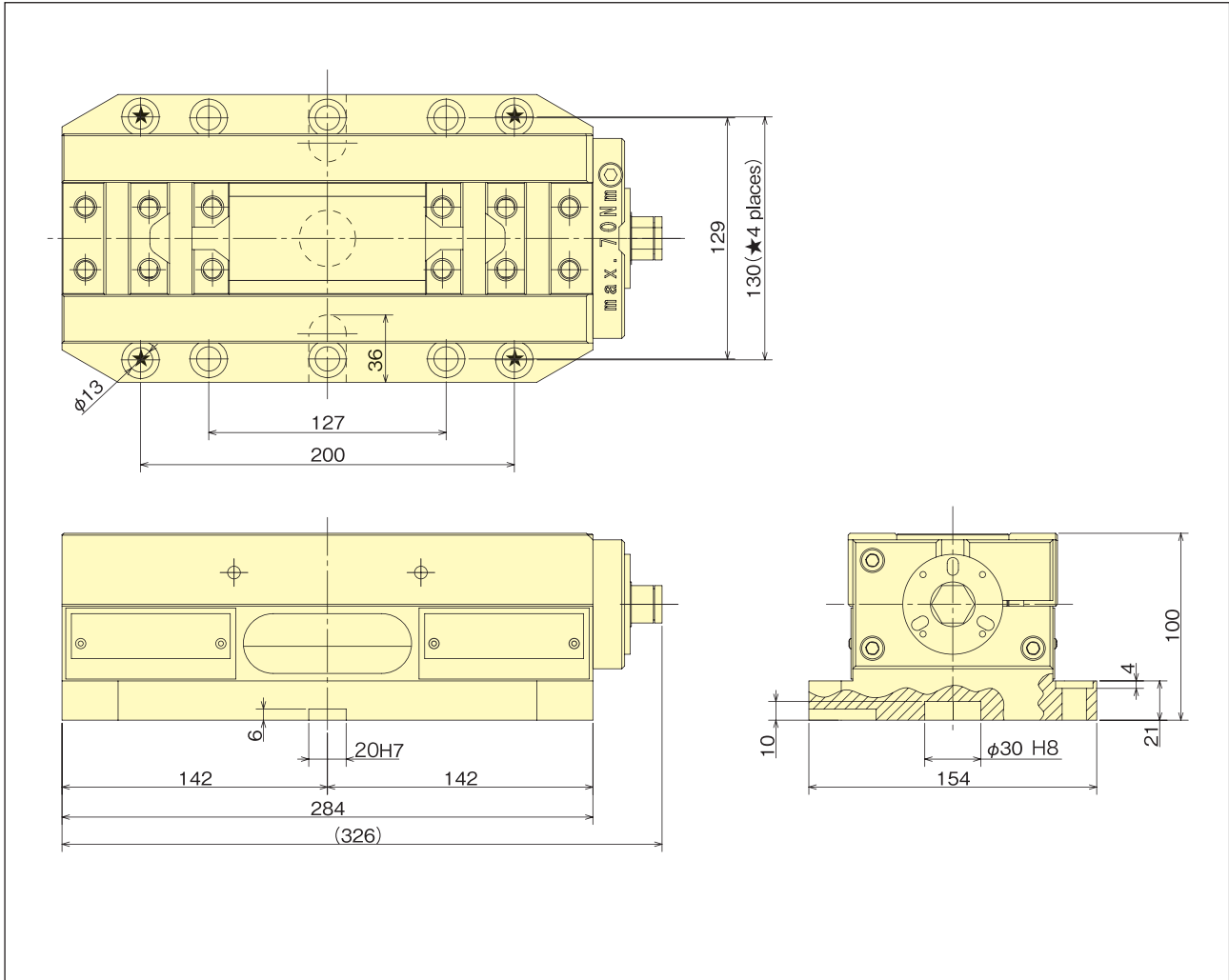

■ Specifications

Model	Total height mm	Full width mm	Full length mm	Max. clamping force kN	Mass kg
VAX125C	100	154	(326)	40	19.5



America Contact

- **KITAGAWA - NORTHTECH INC.**
 Tel. +1 847-310-8787 Fax. +1 847-310-9484
 301 E. Commerce Dr, Schaumburg, IL. 60173 USA
<http://www.kitagawa.com>
- **TECNARA TOOLING SYSTEMS, INC.**
 Tel. +1 562-941-2000 Fax. +1 562-946-0506
 12535 McCann Dr, Santa Fe Springs, California 90670 USA
<http://www.tecnaratools.com>

Europe Contact

- KITAGAWA EUROPE LTD.**
 Tel. +44 1725-514000 Fax. +44 1725-514001
 Unit 1 The Headlands, Downton, Salisbury, Wiltshire SP5 3JJ, United Kingdom
<http://www.kitagawaeurope.com>
- **KITAGAWA EUROPE GmbH**
 Tel. +49 2102-123-78-00 Fax. +49 2102-123-78-69
 Borsigstrasse 3, 40880, Ratingen Germany
<http://www.kitagawaeurope.de>
- KITAGAWA EUROPE GmbH Poland Office**
 Tel. +48 607-39-8855 Fax. +48 32-749-5918
 44-240 Zory, ul. Niepodleglosci 3 Poland
<http://www.kitagawaeurope.de>
- KITAGAWA EUROPE GmbH Czech Office**
 Tel. +420 603-856-122 Fax. +420 549-273-246
 Lysicka 3, 621 00 Brno, Czech Republic
<http://www.kitagawaeurope.de>
- KITAGAWA EUROPE GmbH Romania Office**
 Tel. +40 727-770-329 Fax. +40 372-006-620
 Heliului 15, Bucharest 1, 013991, Romania
<http://www.kitagawaeurope.de>

Asia Contact

- KITAGAWA INDIA PVT LTD.**
 Tel. +91 20-6500-5981 Fax. +91 20-2615-0588
 Lotus House East, Lane 'E' North Main Road, Koregaon Park, Pune, 411 001, Maharashtra, India
- **KITAGAWA (THAILAND) CO.,LTD. Bangkok Office**
 Tel. +66 2-712-7479 Fax. +66 2-712-7481
 9th FL, Home Place Office Building, 283/43 Sukhumvit 55Rd. (Thonglor 13),Klongton-Nua, Wattana, Bangkok 10110, Thailand
- **KITAGAWA IRON WORKS CO.,LTD. Singapore Branch**
 Tel. +65 6838-4318 Fax. +65 6408-3935
 #02-01 One Fullerton, 1 Fullerton Road, Singapore 049213
- **KITAGAWA IRON WORKS (SHANGHAI) CO.,LTD.**
 Tel. +86 21-6295-5772 Fax. +86 21-6295-5792
 Room308 3F Building B. Far East International Plaza,No.317 Xian Xia Road,Chang Ning, Shanghai,200051China
- **DEAMARK LIMITED**
 Tel. +886 2-2393-1221 Fax. +886 2-2395-1231
 No. 6, Lane 5, Lin Sen North Road, Taipei, Taiwan
<http://www.deamark.com.tw>
- **KITAGAWA KOREA AGENT CO.,LTD.**
 Tel. +82 2-2026-2222 Fax. +82 2-2026-2113
 803 Ho, B-Dong, Woolim Lion's Valley, 371-28 Gasan-Dong,Gumcheon-Gu, Seoul, Korea
<http://www.kitagawa.co.kr>

Oceania Contact

- DIMAC TOOLING PTY.LTD.**
 Tel. +61 3-9561-6155 Fax. +61 3-9561-6705
 61-65 Geddes Street, Mulgrave, Victoria, 3170 Australia
<http://www.dimac.com.au>

■ Japanese speaker available



KITAGAWA IRON WORKS CO., LTD.

77-1 Motomachi, Fuchu-shi, Hiroshima-pref. 726-8610, Japan Tel. +81 847-40-0526 Fax. +81 847-45-8911

·Specifications and outside appearance are subject to change without notice due to ongoing research and development.
 ·The color of the actual product may be different from the catalogue's due to printing matters.
 ·Catalogue contents as of 2015.7
 ·The products herein are controlled under Japanese Foreign Exchange and Foreign Trade Control Act.
 In the event of importing and/or exporting the products,
 you are obliged to consult KITAGAWA as well as your government for the related regulation prior to any transaction.