

# TOCSIN 920 SERIES

HMI Based Detector Control Panel

Operation and Maintenance

V1.06



**OLIVER IGD**

**Oliver IGD Limited**

4a Pepper Road  
Stockport  
SK7 5BW  
England

Tel: +44(0)161 483 1415  
Fax: +44(0)161 484 2345  
Email: sales@oliver-igd.co.uk  
Web Site: www.oliver-igd.co.uk



## Table of Contents

<b>Specification</b>	3
<b>CE Declaration</b>	4
<b>Overall Dimensions</b>	5
<b>Interface Wiring</b>	
Highway Hub Overview	6
Relay Card Overview	8
Relay Card Setup	9
Addressable Cable systems	10
<b>Operating System</b>	
Overview	13
Alarm display Mode	14
System Menu's	15
Operational Set up Philosophy	16
Engineers Menu	17
Channel Setup Tab	18
Sensor FIND Function	19
Sensor Setup	20
Sensors Test Function	21
Sensor Diagnostics	22
Sensor Health Check	23
The Relay Output Tab	25
Relay Output Diagnostics	26
Relay Test Function	27
Alarm Relay Setup	29
Calibration Menu Tab	30
Zeroing Detectors	31
Calibrating Detectors	33
One Man Calibration Function	34
GSM Modem Tab	37
Saving and Re-Loading Panel Setup	41
Recommended Setup Sequence	42

### Who Should Use This Manual

Gas detection systems form part of an overall site safety scheme. As such they must be installed commissioned and maintained by competent persons, failure to do so may compromise the overall safety strategy of the site.

This manual and the Tocsin 920 system should only be maintained and installed by trained competent persons.



**This product must be earthed in accordance with local safety regulations.**

The Control Panel leaves the factory configured for the supply voltage stated on the customers order. Standard options are indicated below.

Should the control panel be used in conjunction with portable generating equipment, care should be taken to ensure that the electrical supply is within the tolerance band described above.

The control panel may be stored at temperatures between 0°C and 55°C. If stored at low temperatures and then brought into a warmer environment, condensation may form on some components. In such a situation , this condensation should be allowed to evaporate prior to use of the equipment. If stored at high temperature, care should be taken to ensure that humidity condensation does not enter critical electrical components, for example the power supply.

The Control Panel is designed to operate within specification for ambient temperature between 0°C and 55°C, relative humidity up to 95% ( non-condensing ).

**warning !**

Do not use a Control Panel for protection applications that has not been calibrated. If calibration seals are missing from the control panel or have been tampered with or broken, then the control panel must be re-calibrated and sealed by a trained engineer..

**Basic Specification**

Power	DC Powered Models 19 to 29V DC AC Powered Models 85 to 264v AC 50/60Hz
Ambient Operating Temperature	0 to 55 Degrees Centigrade
Ambient Operating Humidity	0-95% RH Non-Condensing
Protection	IP54
Display	7" Full Colour Touch Screen 800 x 480
Displayed Detector Resolution (Range Dependant)	1% LEL 1%Vol 0.1% Vol 1 ppm 0.1ppm
Connected Hubs	Up to 16 Hubs each with 8 RS485 Highway Ports Max 128 Highways
Connected devices	Up to 250 Devices
CE Declaration	BS EN 61000-6-4 2001 BS EN 61000-6-2 1999 EN61010-1: 2001  89/336/EEC Electromagnetic Compatibility Directive, amended by 93/68/EEC 72/23/EEC Low Voltage Equipment Directive, amended by 93/68/EEC

**EC Declaration of Conformity**

89/336/EEC Electromagnetic Compatibility Directive,  
amended by 93/68/EEC  
72/23/EEC Low Voltage Equipment Directive, amended by  
93/68/EEC

Oliver Ref	T920ECDEC
Product	Tocsin 920 Multi Channel Gas Detector Control Panel
Date	May 2009
Approval Method	Technical Construction File Ref TCF-T920-A
Manufactured By	Oliver IGD Limited 4a Pepper Road Stockport SK7 5BW England.
Declaration	Oliver IGD Limited state that:-  The equipment listed above conforms to the requirements of the EMC directive.
Standards Applied	BS EN 61000-6-4 2001 BS EN 61000-6-2 1999 EN61010-1: 2001

Oliver IGD Limited operate an ISO9000 Quality System  
which incorporates the requirements of the directive.



Signed	Andrew Collier. Director
--------	-----------------------------

## 19" Rack Mount systems

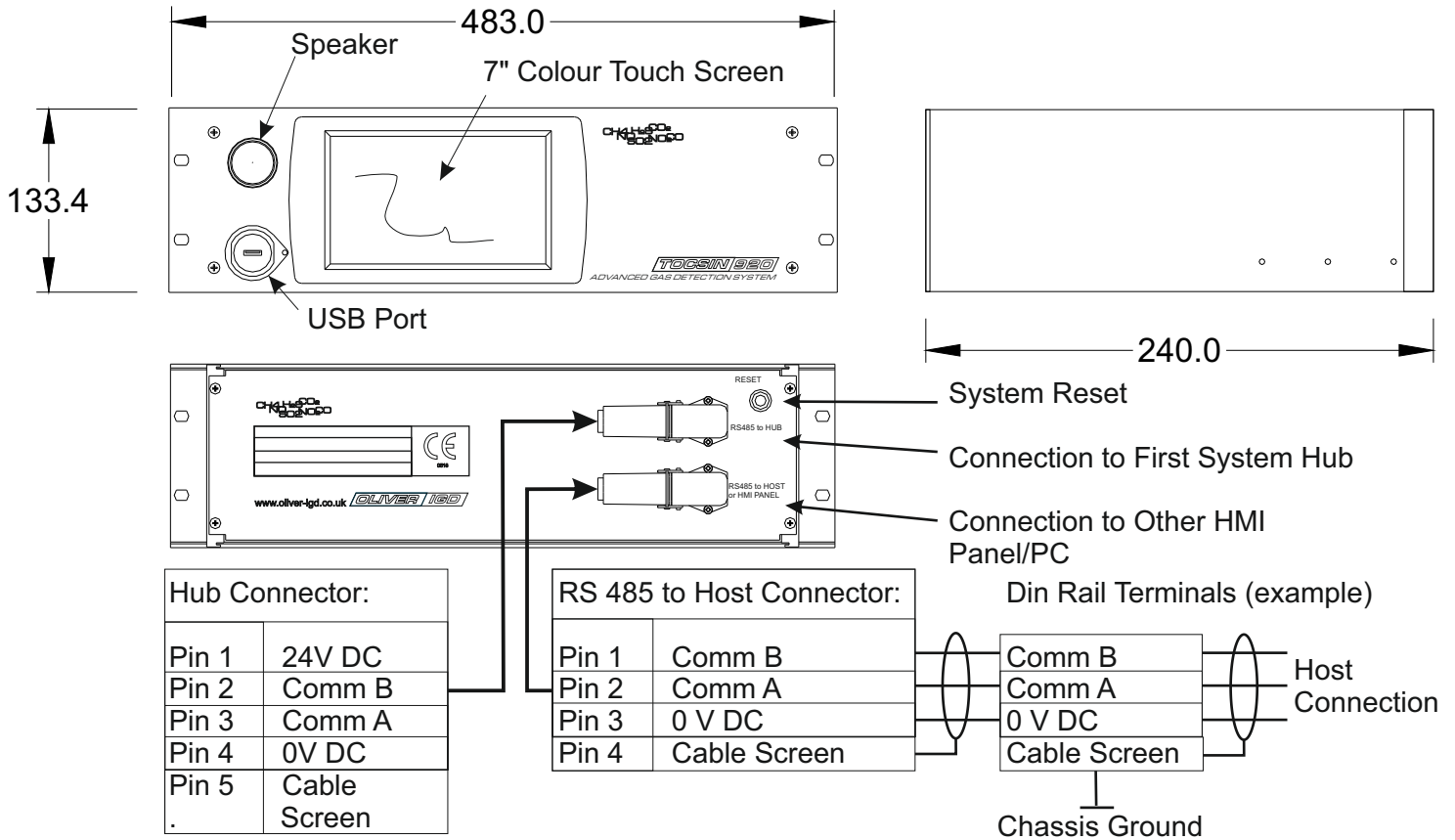

## Basic Wall Mount systems

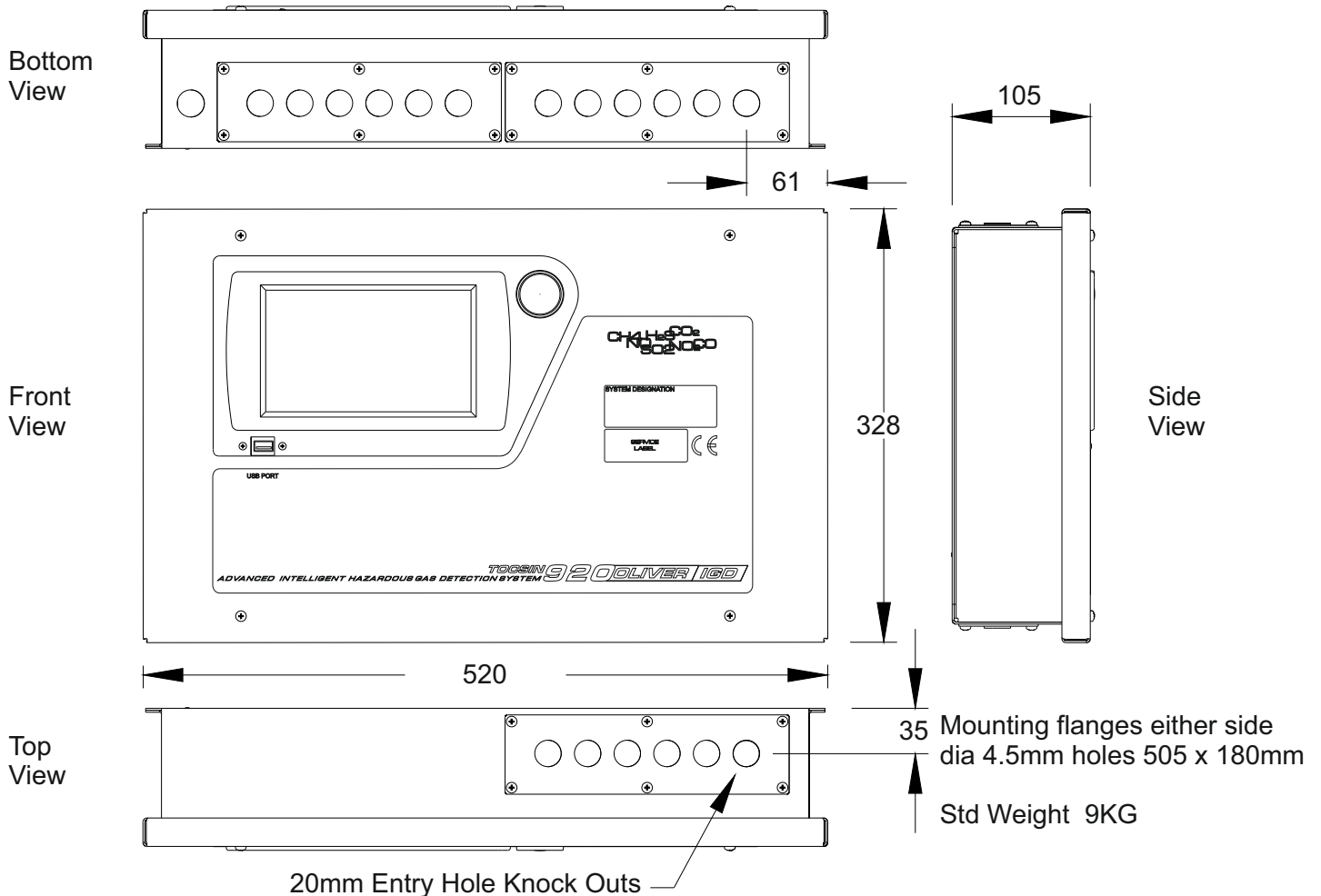

## Tocsin 920 Highway Hub Overview

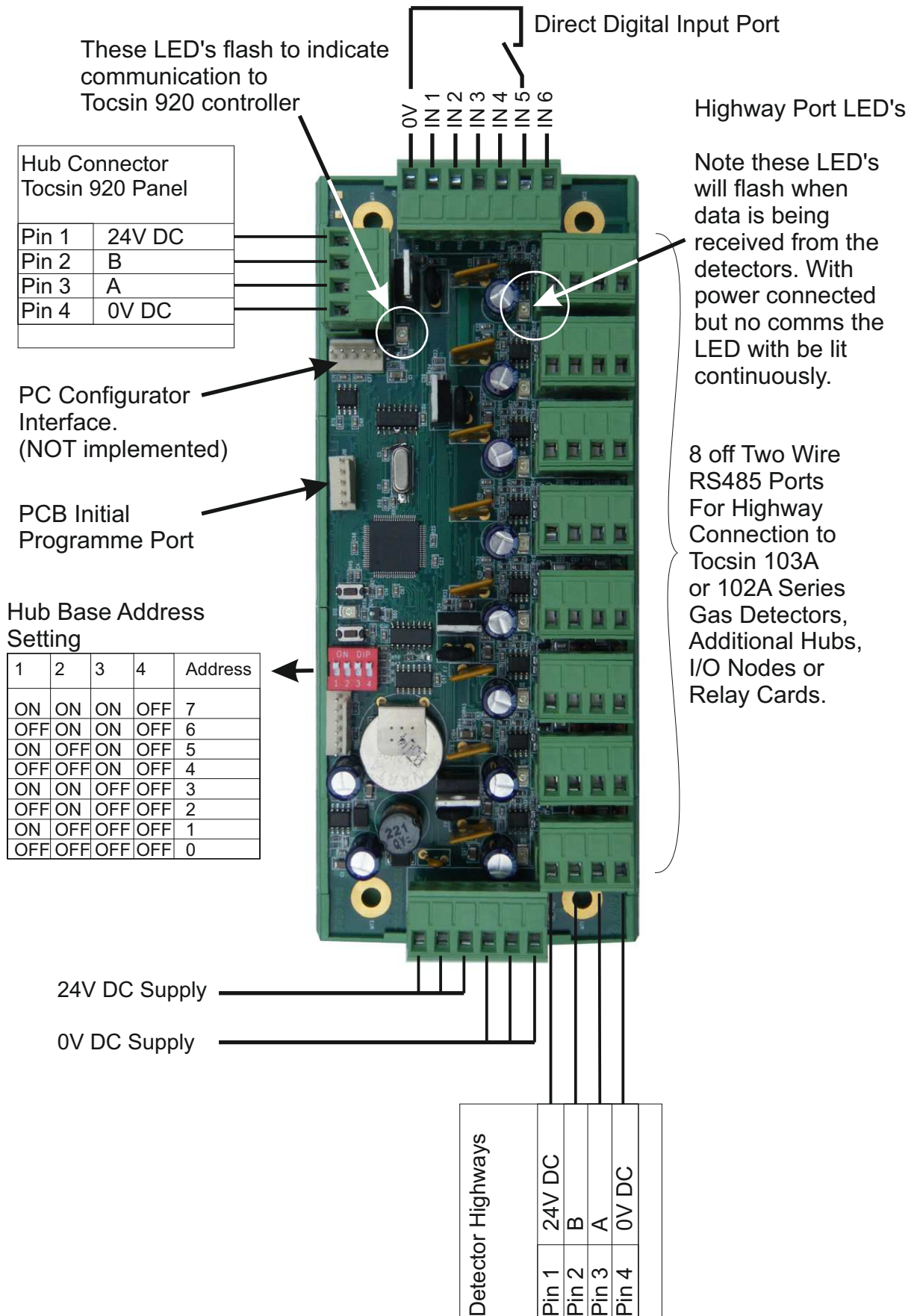

## Tocsin 920 Highway Hub Single Ended Cable Operation

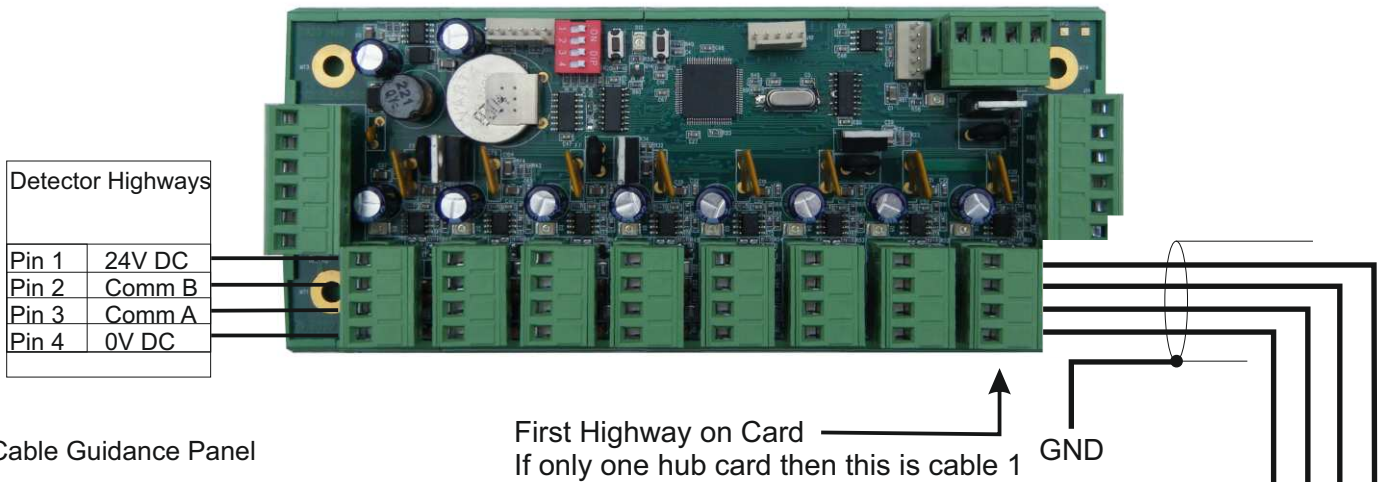

It is imperative to use cabling which suits the environment in which the T920 and its sensors are to be used. The following is intended as a guide only. Always use screened cable.

- Fit 1.5mm SQ cable for analogue systems
- Fit 2.5mm SQ cable for addressable systems (refer to OIGD Cable Calculator for full information)

### Use

Pirelli LSX type cable for office/light commercial installations

Steel Wire Armored or CY cable or conduit for medium/heavy industrial installations.

Not that ATEX standards state that cables should have the required degree of mechanical protection for the are in which they are to be installed.

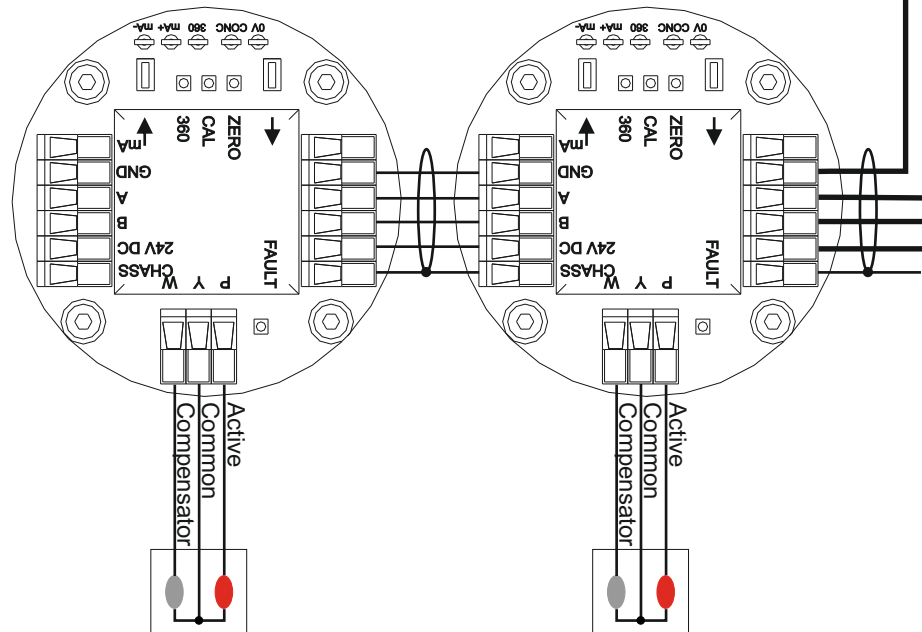

## Tocsin 920 Highway Hub Single Loop Back Cable Operation

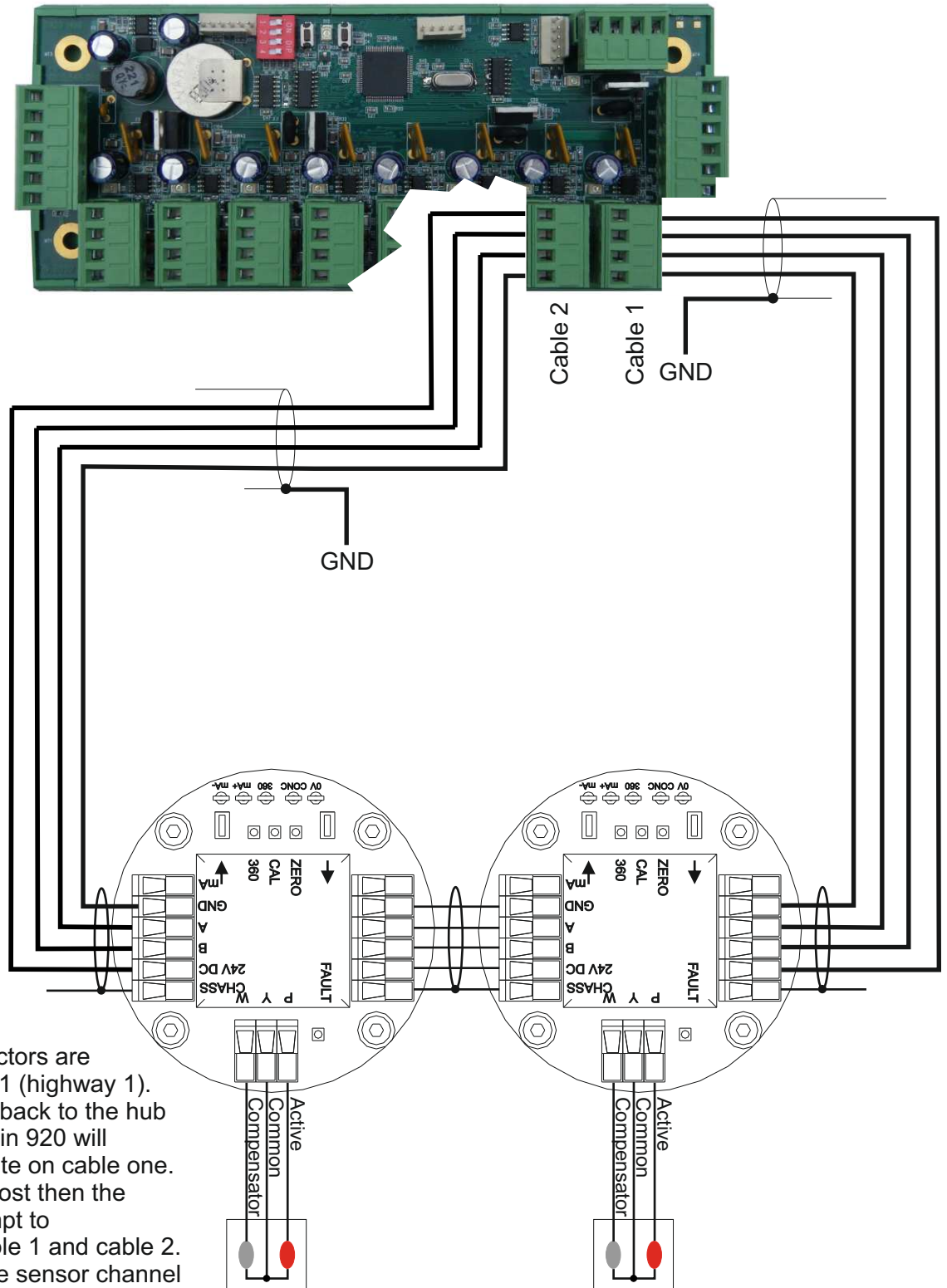

In this example detectors are installed onto Cable 1 (highway 1). They are then wired back to the hub to Cable 2. The Tocsin 920 will primarily communicate on cable one. If communication is lost then the Tocsin 920 will attempt to communicate on cable 1 and cable 2. If this occurs then the sensor channel select button will turn yellow to indicate that channel is communicating in loop back mode due to some cable error. Once the error is corrected the channel select button will revert to being green.

The loop back function is intended to provide increased cable integrity in the event of cable breaks or similar on site. Note that loop back must be selected in the system set up menu and the correct highway cable and loop back cable set up in the channel set up menu.



## Tocsin 920 Addressable Relay Card

In all Cases:  
 Relay contact ratings.  
 7A @ 250V AC Non-Inductive  
 7A @ 30V DC Non-Inductive  
 Spike suppression must be fitted  
 Note that FAULT relays are normally energised on power up.

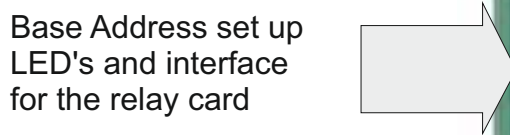
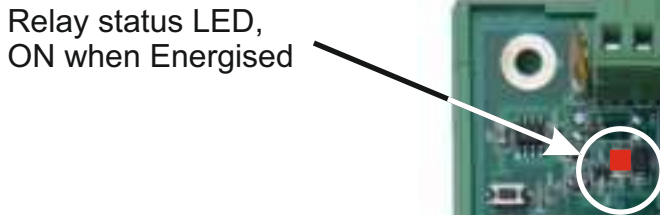
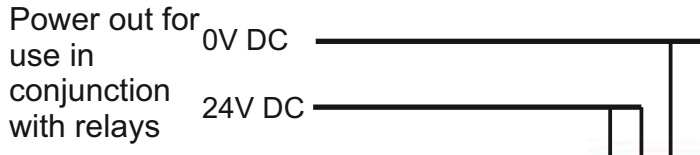

### Highways Connection

Pin 1	0V DC
Pin 2	Comm A
Pin 3	Comm B
Pin 4	24 V DC

Pin 1	0V DC
Pin 2	Comm A
Pin 3	Comm B
Pin 4	24 V DC

### Highways Connection

Note relay status LED's colour for first relay are different if it is designated as a fault relay in Tocsin

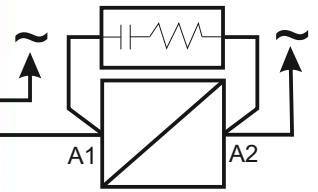
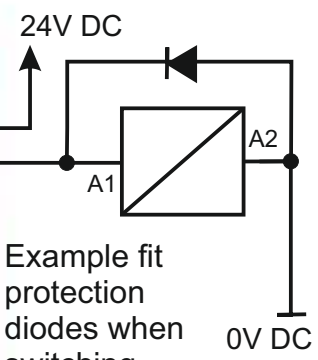
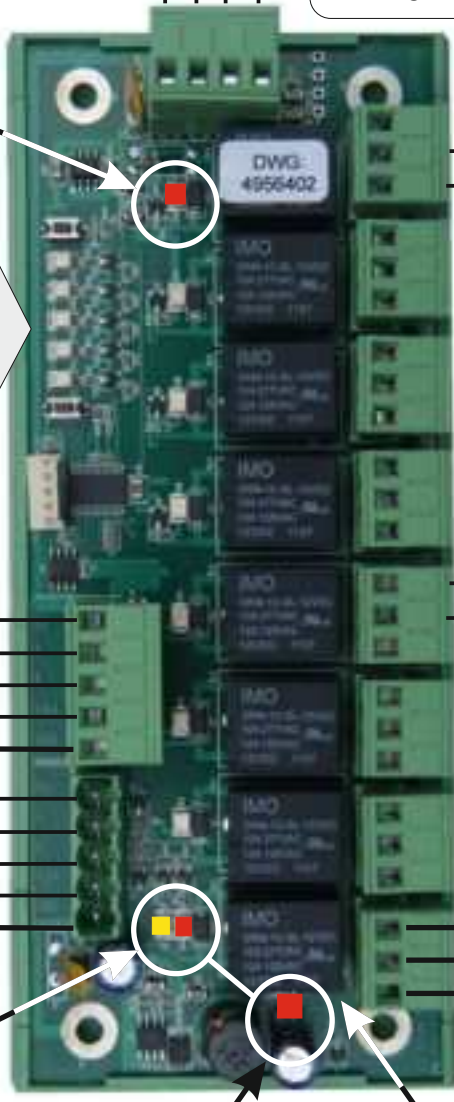

Normally Closed
Common
Normally Open

### Relay Terminals

First Relay on The Card (relays number from this one).

From the controller software, the first relay on a card can be designated as a 'Fault' indication relay. If this is the case this LED will be lit and the relay action is reversed, that is it is normally energised and will de-energise on power failure or any system fault that is detected. Note also that the relay state LED is RED if it is NOT designated as a FAULT relay and YELLOW if it is designated as a FAULT relay

## Tocsin 920 Addressable Relay Card Setting Relay Addresses

Each Addressable relay card must have its own unique base address. This can be set on the card and is indicated below. The relays are then addresses/numbered from that base address. The example below shows a card with a default base address of 4200

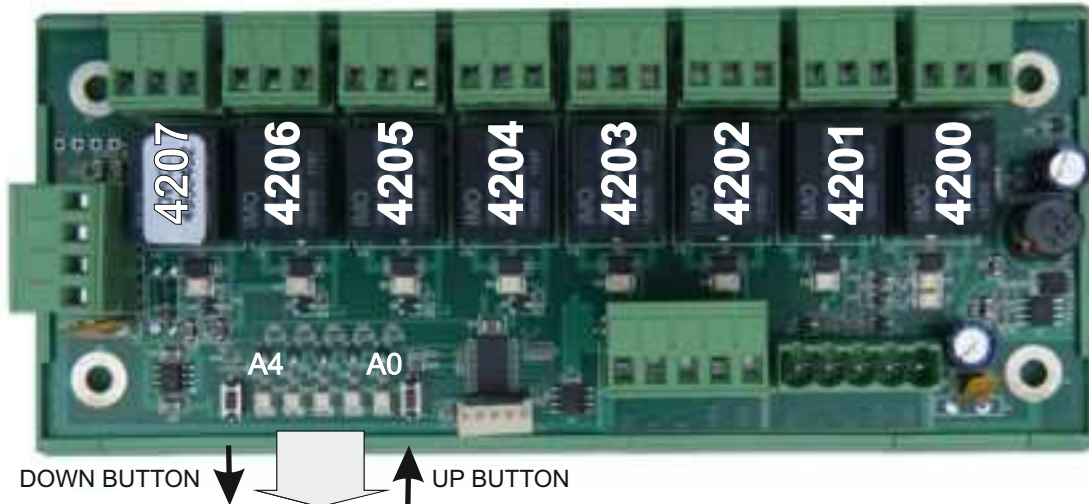

Press and hold the DOWN button until all LED's are OFF. Release the button and the address currently set will be illuminated on the bottom five LED's.

Use the UP and DOWN buttons to alter the address set as indicated in the table below

To exit press and hold UP or DOWN button until all LED's are off then release.

Note:  
In normal operation with Power applied A0 is on. With comms traffic A0 will also flash.

A4	A3	A2	A1	A0	Address	A4	A3	A2	A1	A0	Address
					4200	☼					4328
				☼	4208	☼				☼	4336
			☼		4216	☼			☼		4344
			☼	☼	4224	☼			☼	☼	4352
		☼			4232	☼		☼			4360
		☼		☼	4240	☼		☼		☼	4368
		☼	☼		4248	☼		☼	☼		4376
		☼	☼	☼	4256	☼		☼	☼	☼	4384
	☼				4264	☼	☼				4392
	☼			☼	4272	☼	☼			☼	4400
	☼		☼		4280	☼	☼		☼		4408
	☼		☼	☼	4288	☼	☼		☼	☼	4416
	☼	☼			4296	☼	☼	☼			4424
	☼	☼		☼	4304	☼	☼	☼		☼	4432
	☼	☼	☼		4312	☼	☼	☼	☼		4440
	☼	☼	☼	☼	4320	☼	☼	☼	☼	☼	4448

## Tocsin 920 Addressable Cable Systems.

This example block diagram shows a Tocsin 920 19" rack unit connected to two external highway hubs, two 8 way relay cards, one two way relay card and three addressable gas detectors. This block diagram shows typical addressing and port numbering.

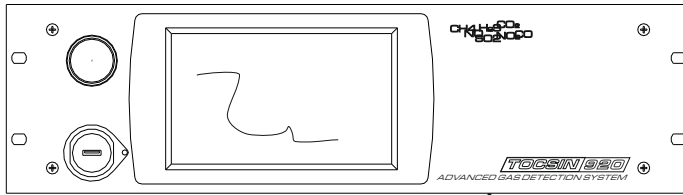

Hub address set here see previous.

Note for multiple hub systems the overall cable distance between hubs and the Tocsin 920 cannot exceed 1KM

Power for hub, detectors and Tocsin 920 Controller if Hub 0.

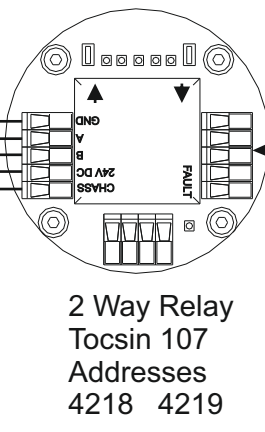
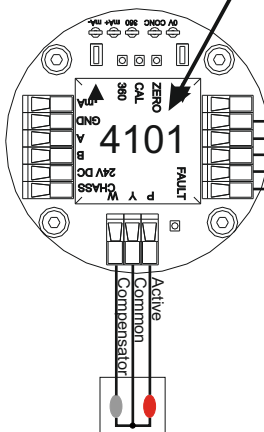
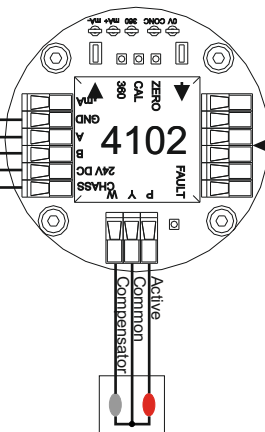
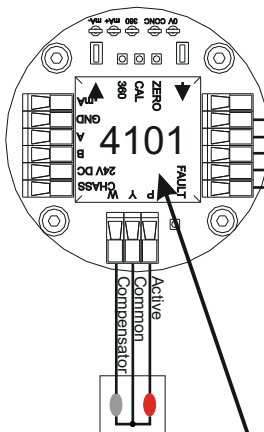
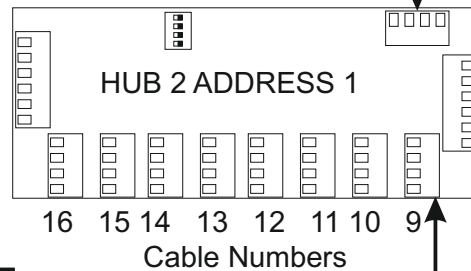
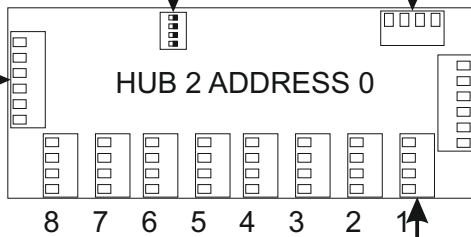

Note that the same detector address can be used on different cable runs. All addresses on a common cable must be unique

2 Way Relay Tocsin 107 Addresses 4218 4219

Relay Card 1 Base Address 4200

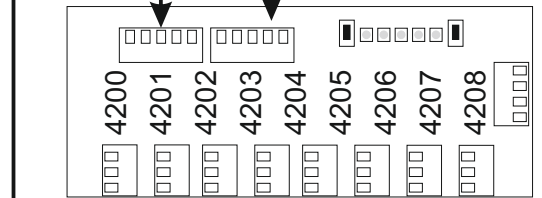

Relay card base address set here see previous.

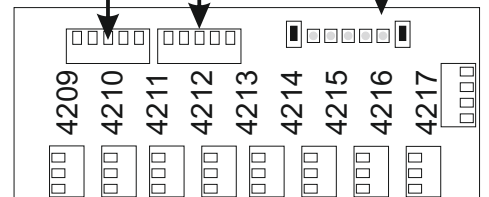

Relay Card 2 Base Address 4209

Note that detectors and hubs can be field powered to reduce issues from cable volt drop or for convenience of installation. PSU's employed must typically conform to:

- Min 18V DC at all field wiring points
- Ripple & Noise max 150mV P-P
- Line regulation +/- 0.5%
- Voltage Tolerance +/-2%
- Load regulation +/- 1.0%

Failure to meet the minimum required PSU specification can lead to in service problems.

## Tocsin 920 Addressable Cable Systems Continued....

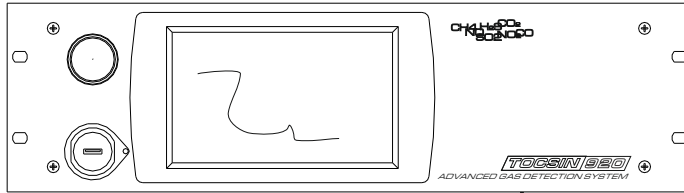

This example block diagram shows a Tocsin 920 19" rack unit connected to one external highway hub and two gas detectors.

In this example the two gas detectors are locally powered which means that a three core cable can be run back to the highway hub.

Hub Connector:

Pin 1	24V DC
Pin 2	Comm B
Pin 3	Comm A
Pin 4	0V DC

The cable is screened at both ends/junction boxes and the 0V DC connection is brought back to the hub from the field devices as a precaution.

Note that power boosters can be added in the same way but using all 4 cable terminations where long cable runs result in voltage drop problems.

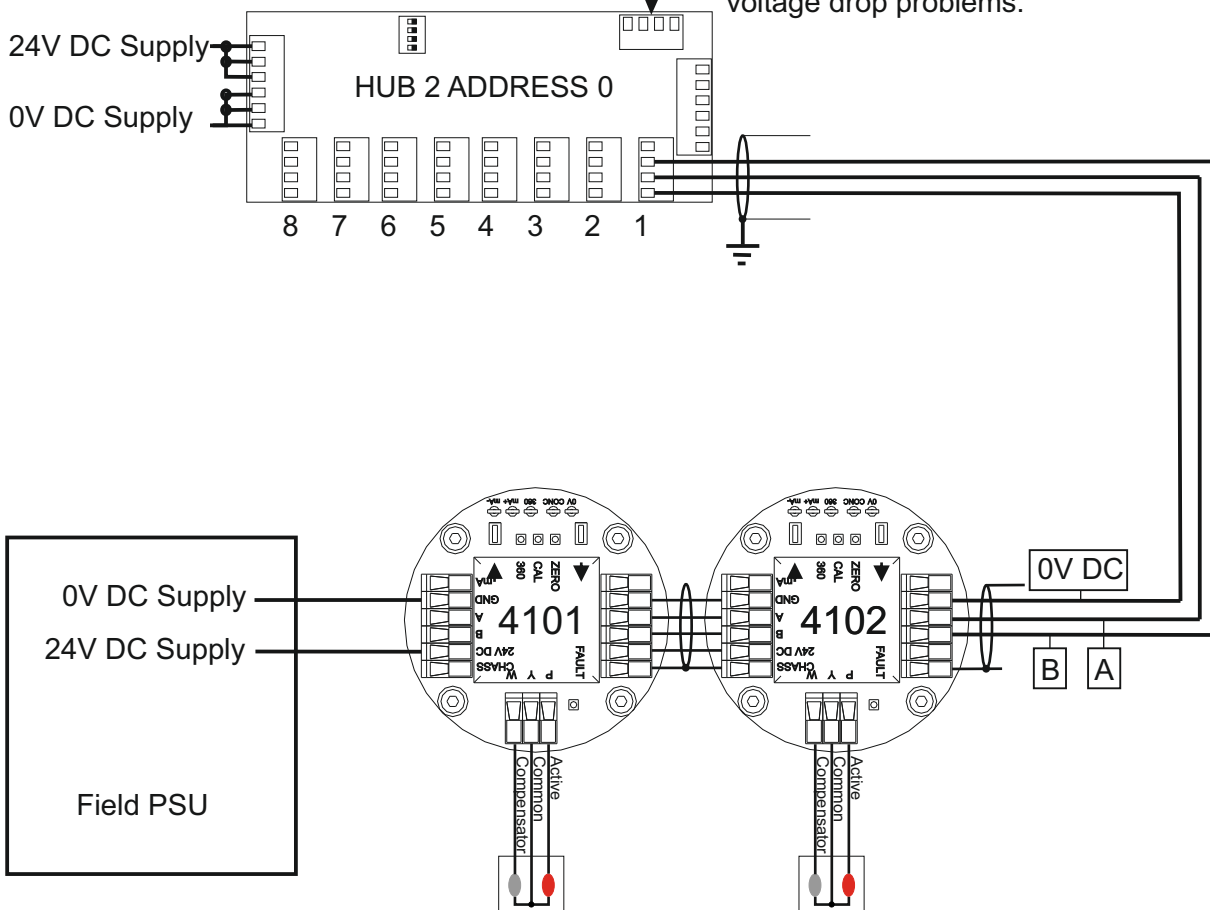

## Operating System

On powering of the system, there is an initial count down to allow detectors time to stabilise. This period can be configured in the engineers menu options to suit particular applications. During this warm up period all alarms are inactive.



After the countdown period the system goes into normal monitoring operation.

Sensor TAG, alarm levels and status displayed

Gas Detector Type Digital and Analogue Readings

Select to Disable the Current channel (Pass Key Protected)

Alarm 3 Level

Alarm 2 Level

Alarm 1 Level

In General:

Green = Normal

Red = Alarm

Yellow = Fault

Black = Disabled

Click on a displayed channel number to make it the currently viewed channel or type in the channel number of interest. Note that the display centres on the selected channel and displays its current status

## System Display When in Alarm

If beacons and sounders are connected using 107 series relay nodes then the sounders can be muted. Note there are selections to mute all connected 107 series sounders or just the 107 series sounder that corresponds to this channel.

Note that if alarms are set as latching there are also options to try and reset just this channel or all channels that are in alarm. To reset a latching alarm you must be below the alarm level.

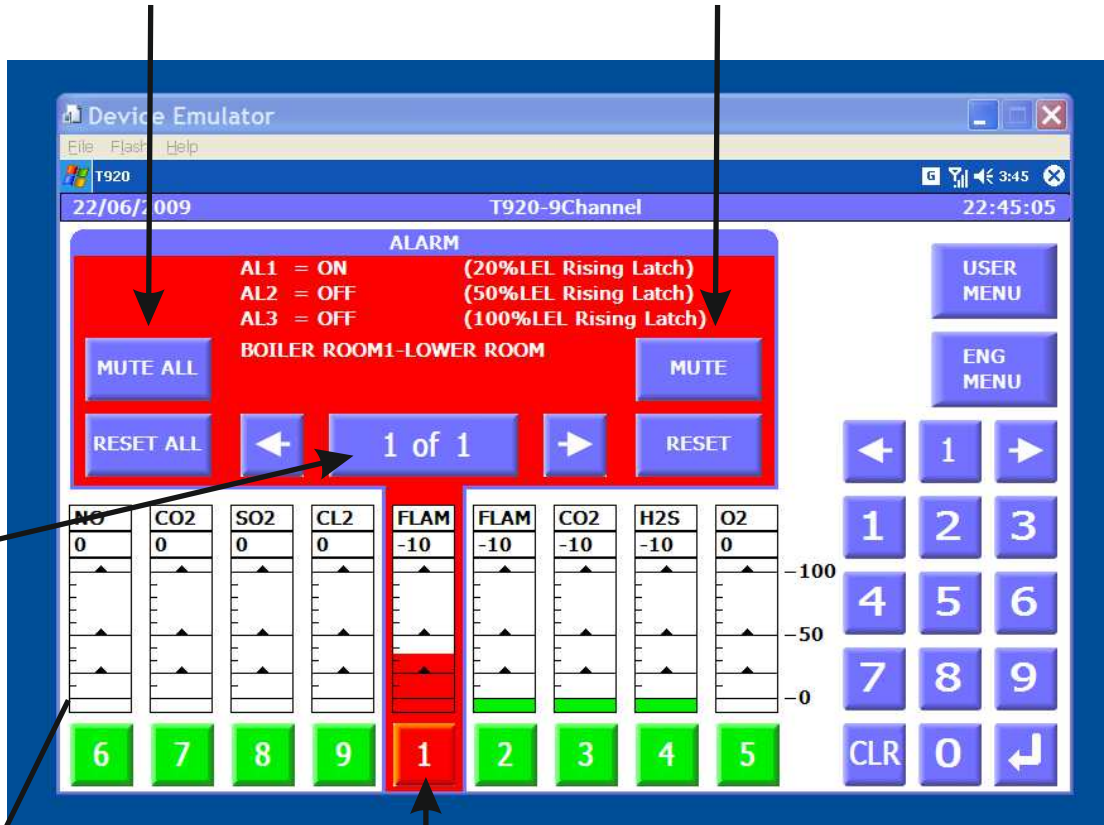

The number of active alarms is displayed. Use the left and right keys to select between channels in alarm.

when the system goes into alarm the display immediately selects the first channel that went into alarm to be the current channel

### Bar Graph Alarm Level Indicators

Gas levels must exceed an alarm level for the alarm to become active. A delay before alarm can be set in the engineer menu and is common in ventilation applications to introduce additional hysteresis into a system.



**Rising Latching Alarm Level**  
Note Latching Alarms Stay Active After The Gas Level Has Gone and Must be Physically Reset



**Rising Alarm Level**  
Rising Alarms Automatically Reset Themselves After The Gas Level Has Gone



**Falling Alarm Level**  
(Typically for Oxygen Depletion Alerts)  
Falling Alarms Automatically Reset Themselves After The Gas Level Has Gone



**Falling Latching Alarm Level**  
Note Latching Alarms Stay Active After The Gas Level Has Gone and Must be Physically Reset

## System Menu Access and Options

The Tocsin 920 operating system has two access levels for set up and maintenance functions. The basic menu layout is indicated on the diagram below.



Note that the User Menu items are repeated on the Engineer Menu. For the balance of this manual only the engineer menu functions are discussed.

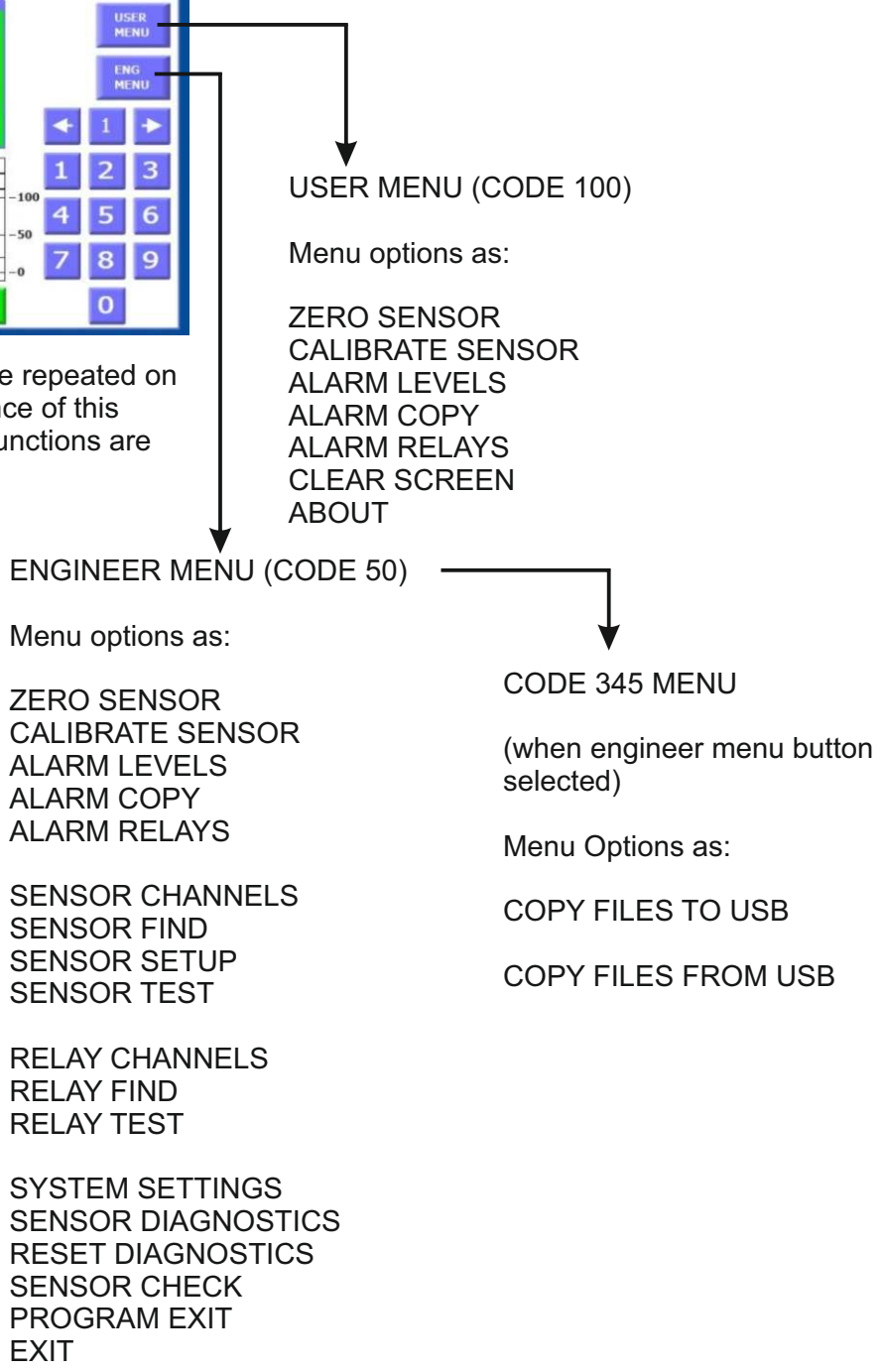

## Operational Set up Philosophy

The Tocsin 920 controller forms the operational core of an addressable gas detection system.

ALL elements of the system such as detectors, highway hubs, relay outputs etc have addresses on the system.

During set up and commissioning the inputs and outputs to and from the Tocsin 920 are defined with their addresses.

The diagram below shows a typically hierarchy.

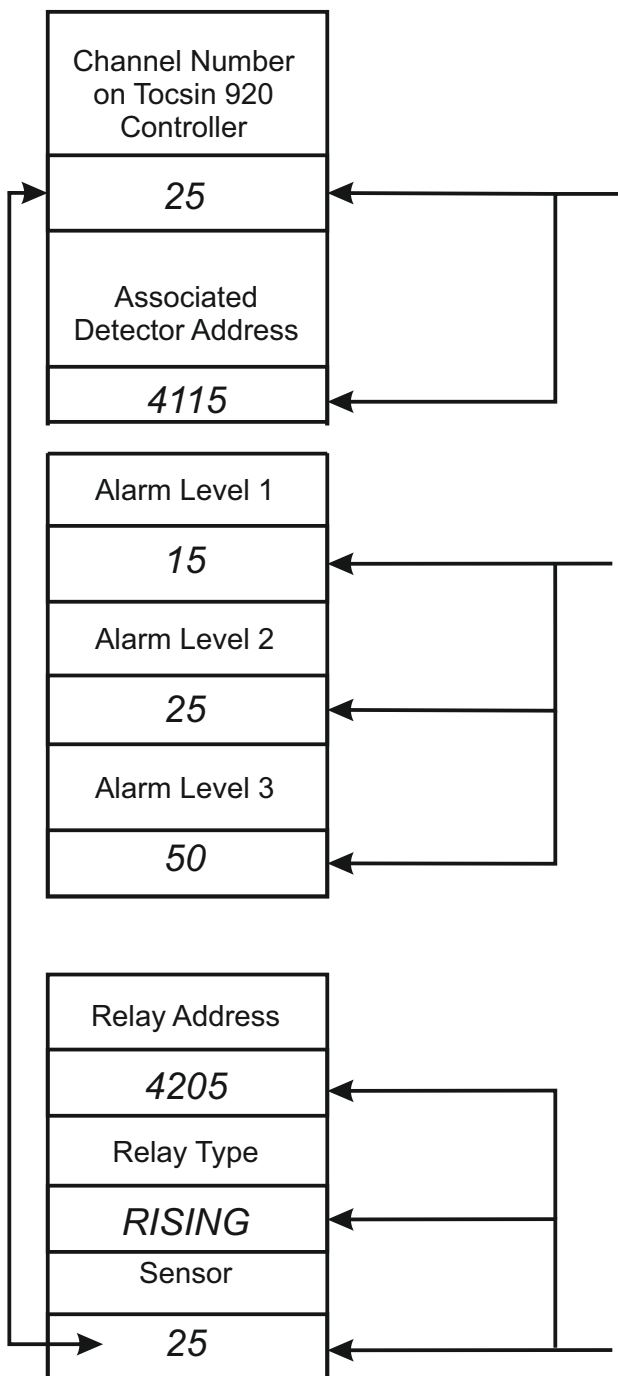

In this example for this particular channel (25) on the Tocsin 920 controller the gas detection readings are coming from detector 4115. This is setup in the SENSOR SETUP menu.

The required alarm levels are set up in the ALARM SETUP menu. Three alarm levels are possible for each channel as AL1,AL2 and AL3. The type of alarm is also setup in this menu as one of either:

### RISING ALARM

*Alarm on rising gas level once set point is exceeded. Alarm resets after gas level is below the alarm point.*

### RISING LATCHING ALARM

*Alarm on rising gas level once set point is exceeded. Alarm must be manually reset after gas level is below the alarm point.*

### FALLING ALARM

*Alarm on falling gas level once level is below set point. Alarm resets after gas level is above the alarm point.*

### FALLING LATCHING ALARM

*Alarm on falling gas level once level is below set point. Alarm must be manually reset after gas level is above the alarm point.*

These options are configured in the RELAY SETUP menu which allows relay alarm outputs to be assigned to particular channels or groups of channels For complete details on alarm options see the Alarm Setup Menu section later in this manual.



## The Engineer Menu (Passcode 50)



Select Engineer Mode and enter pass code 50  
The following menu is then displayed

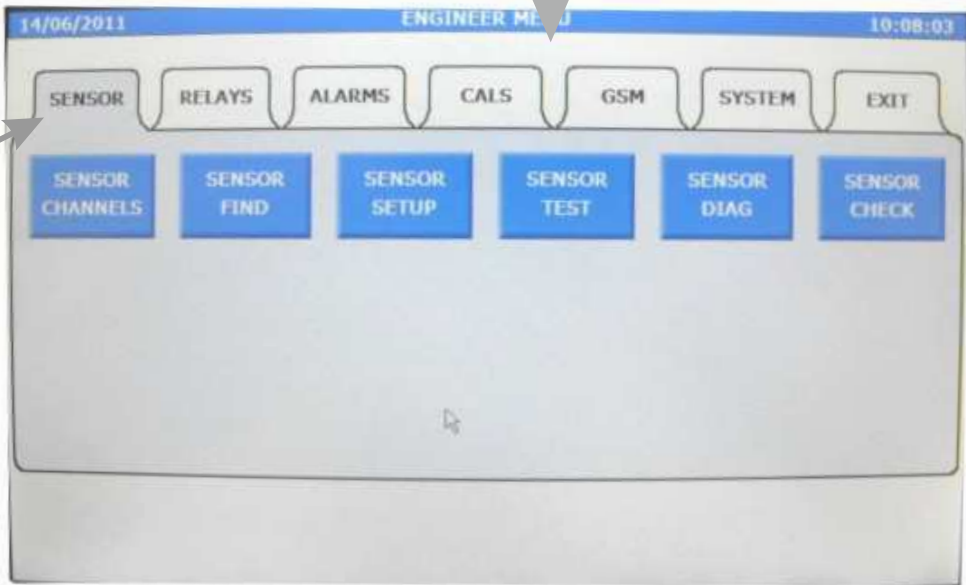

Select the tab at the top of the folder to access each section. Note that the sensor tab is displayed with its page options by default. Select the EXIT tab to return to normal operation.

### TAB GROUPS

### FUNCTIONS

#### SENSOR

Sensor Channels (Change the number of active channels)  
Sensor FIND (use to find addressable sensors)  
Sensor Setup (setup channel parameters)  
Sensor Test (Communication test function)  
Sensor Diagnostics (Full diagnostics for the chosen detector)  
Sensor Check (Sensor diagnostic Health Check)

#### RELAYS

Relay Channels (Change the number of system relays)  
Relay FIND (use to Find addressable relays)  
Relay Diagnostics (Communication test function)  
Relay Test (Physical relay test)

#### ALARMS

Alarm Levels (set alarm levels for each detector)  
Alarm Copy (copy alarm set up between channels)  
Alarm Relays (Set up parameters for alarm activation)

#### CALS

Zero Sensor (Use to zero an individual sensor)  
Zero All Sensors (Zero all connected sensors)  
Calibrate Sensor (Calibrate an individual sensors)  
One Man Calibration (one man walk round calibration)

#### GSM

GSM Setup (Use to set up GSM functions)  
|GSM Test (Test GSM operation)

#### SYSTEM

Main global system settings

#### EXIT

Exit to normal gas detection operation

## The Sensor Setup Tab

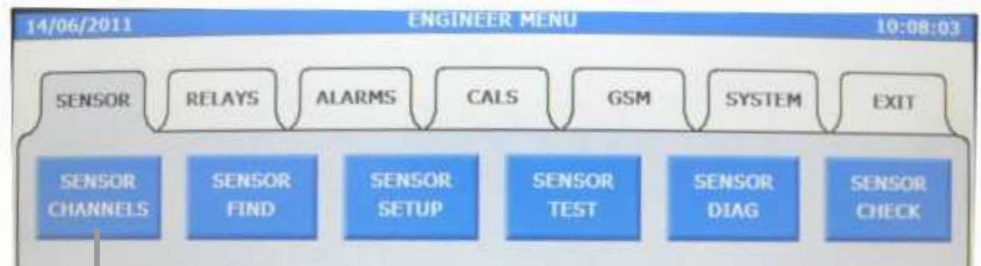

Select the sensor channels option to set the number of active channels

## The Sensor FIND Function

The sensor FIND function is used during initial set up of the system to test that all connected detectors communicate to the control panel. The function can also be used to automatically install onto the panel all of the detectors which are 'found'. By doing this channels are automatically set up on the controller for the Address, Cable, Range, Gas Type etc. This will speed channel set up but it should be noted that performing a FIND and auto install will erase all the existing set up information including alarm levels and alarm action types.

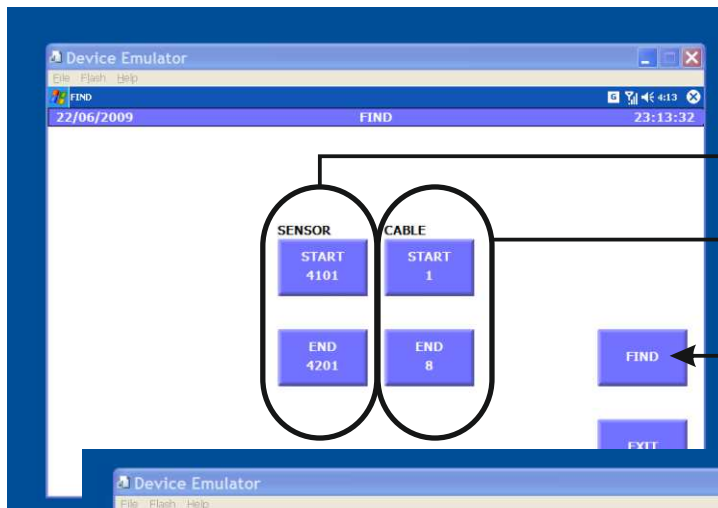

Select the start and end address to search between.

Select the cable numbers to search

Select FIND to start searching for detectors.



The display will show how many detectors were found, on which cables and indicates the first address found on the cable

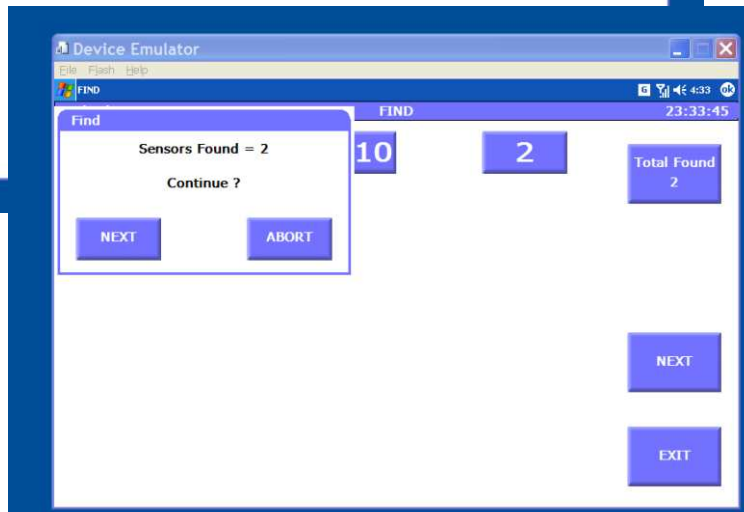

The display now indicates how many sensors have been found.

At this stage this may just be useful diagnostic information in which case select ABORT to exit the sensor FIND or....

Select NEXT to continue and automatically install sensors onto the system

## The Sensor FIND Function....Automatic Install

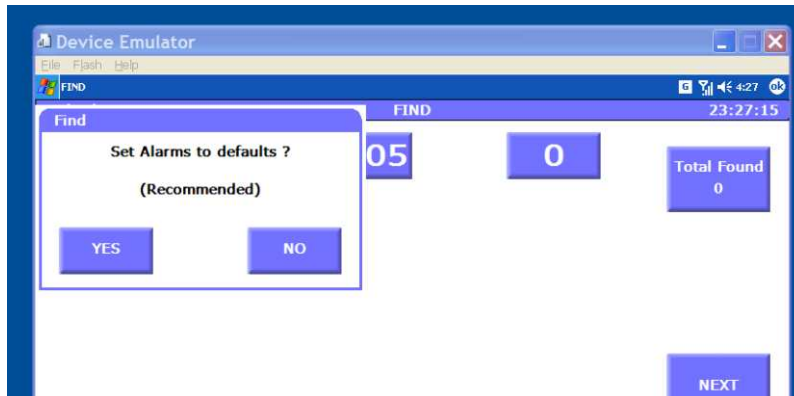

You have the option now to either manually set up system alarms or allow the system to set alarm to defaults. These can be globally set then as

- AL1 at 20% of detector range
- AL2 at 50% of detector range
- AL3 at 100 % of detector range

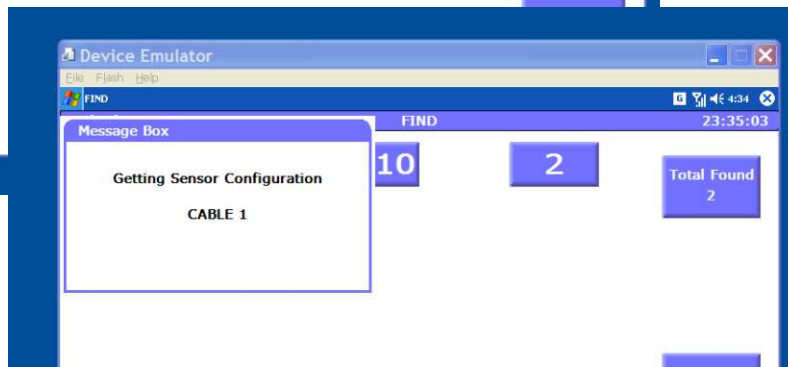

The system now interrogates the detectors to retrieve the set up data from each detector head.

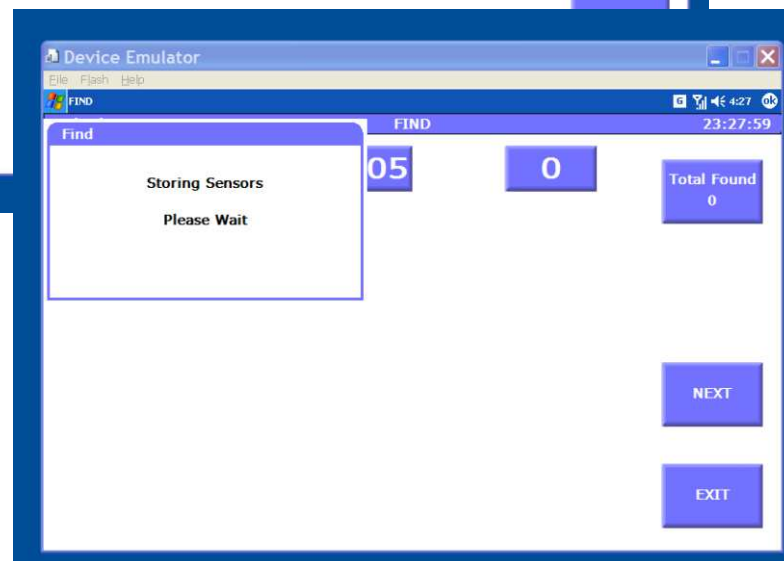

Once the data is retrieved the system stores the information to each channel as the detectors are listed as:

Cable number and detector number.

So Channel 1 will have the first cable, cable 1 and the first detector address typically 4101 etc.

Notes

## The Sensor Setup Menu

Tap here to enter the on screen tag for the detector (max 32 characters)

For this channel enter the address which is to relate to this channel.

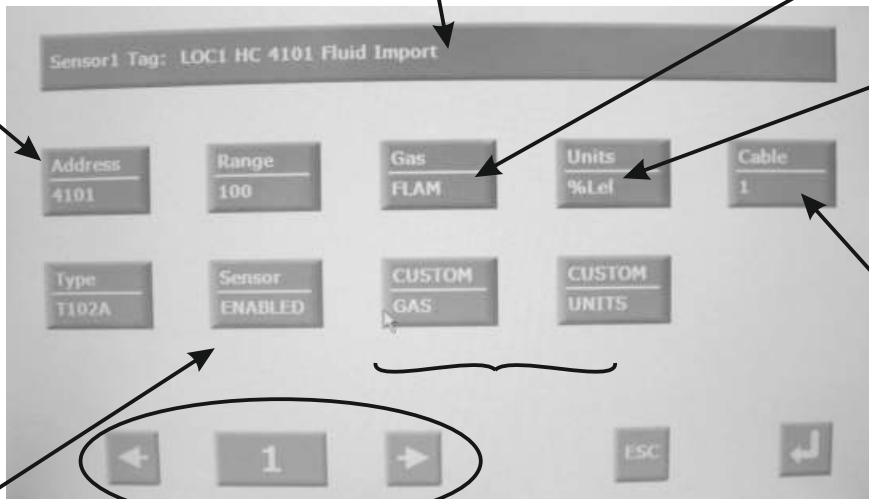

Select gas FLAMM, CO, CO2 etc

Enter the UNITS to display. % LEL, ppm,%Vol etc

Enter the hub cable number that this detector is installed onto. Note there is also an option for a Loop Back port (Cable LB) if the detector is on a double ended highway. Note the first hub is cable numbers 1 to 8, the next hub 9-16 etc.

Select to temporarily enable or disable a channel

Select to move between channels. Tap on the channel number to type in the channel number if known.

Use these two settings to set up custom inputs for non-listed non-gas detector devices. Typically used when integrating other sensors onto the highways using 110 series input nodes

Note that when a set up button is selected a popup menu appears to allow data to be typed into the set up box.

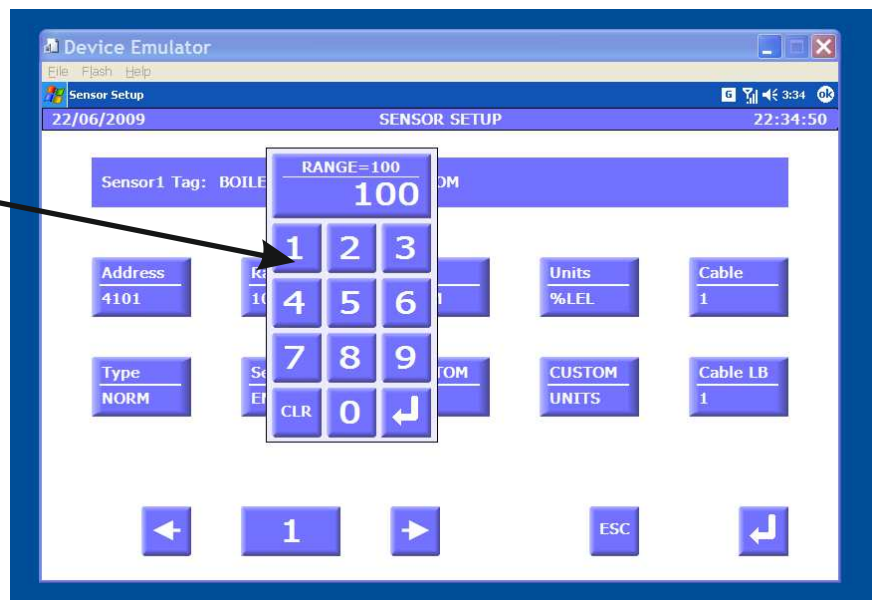

Notes

## The Sensor Test Function

The sensor comms test function is a diagnostic check which provides information regarding the ability of the Tocsin 920 controller to communicate to all its connected detectors.

When sensor test is selected the following diagnostic screen is displayed.

The display shows eight sensor channels at a time. Use the left and right keys to display more channels. The return key ends the diagnostic.

	Conc	Errors	Tx	Rx	T.Out	FEC	HUB
S1	0.0	0.00%	83	83	0	0	11
S2	0.3	0.00%	83	83	0	0	11
S3	0.0	0.00%	83	83	0	0	11
S4	0.0	0.00%	83	83	0	0	11
S5	0.0	0.00%	83	83	0	0	11
S6	0.0	0.00%	83	83	0	0	11
S7	0.0	0.00%	83	83	0	0	11
S8	0.0	0.00%	83	82	0	0	11

Sensor Channel Number

Detector Concentration

Errors detected as an overall percentage of Tx transmissions

Number of requests for data

Number of successful replies to data request

Hub Errors, both timeouts and FEC errors just for the hub comms.

Number of corrupted data packets

Number of time outs. i.e detector did not respond quickly enough to request for data from Tocsin 920.

Note that the overall percentage error rate should be less than 0.5%.

Anything greater than this is indicative of a problem requiring correction. Usual errors arise from poor cable termination or poor cable screening and should be corrected prior to final commissioning.

## Sensor Diagnostic Functions.....Sensor Health Check...Individual Channel

From the sensor diagnostic screen selecting sensor check will initiate a health check of the currently displayed detector.

The checking algorithm checks for reported faults and also that calibration and zero voltages are in line with detector ranges and gas concentrations used for calibration.

A typical screen shot is indicated below.

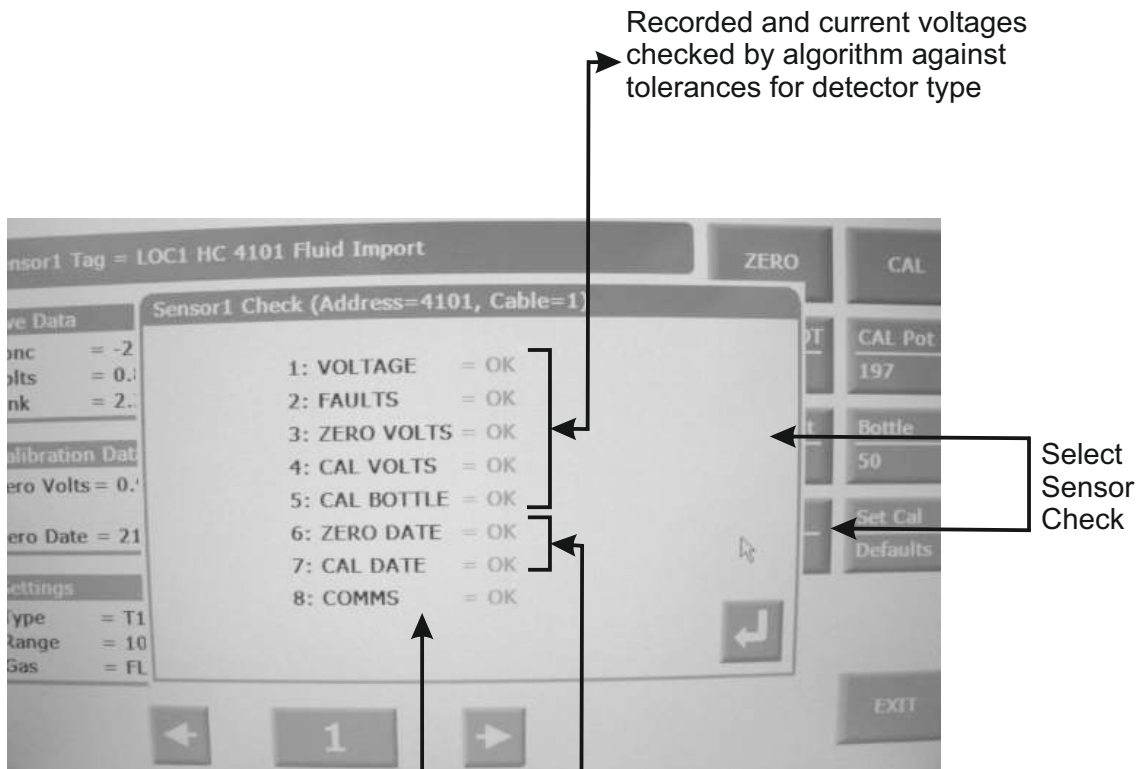

Comms will indicate a fault if communication errors (either data time outs or corrupt data packets) exceed 0.5% of overall data transmissions.

Note:

TEXT IN GREEN ALL OK

TEXT IN YELLOW - WARNING

TEXT IN RED - FAULT

## Sensor Diagnostic Functions.....Sensor Health Check...Global

In addition to the individual sensor health check the system can perform a global health check across either a range of connected detectors or all connected detectors.

Sensor check is selected as an option from the main engineers Menu. The following screen is then displayed

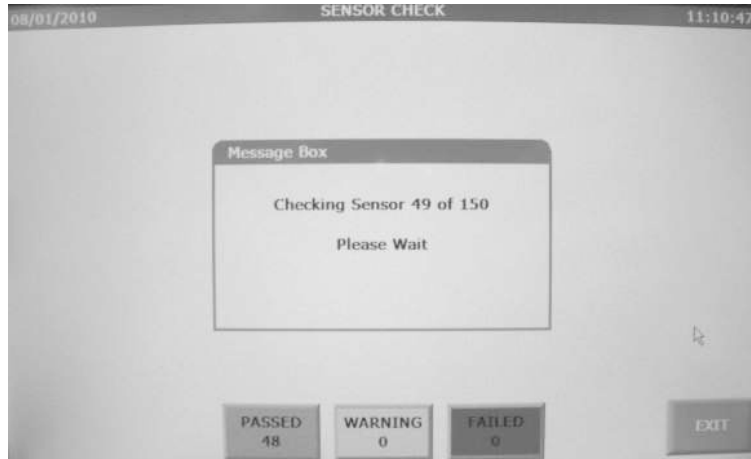

Once run the option will check all connected detectors using the same algorithms employed in the individual sensor check. The tests progress is indicated on screen.

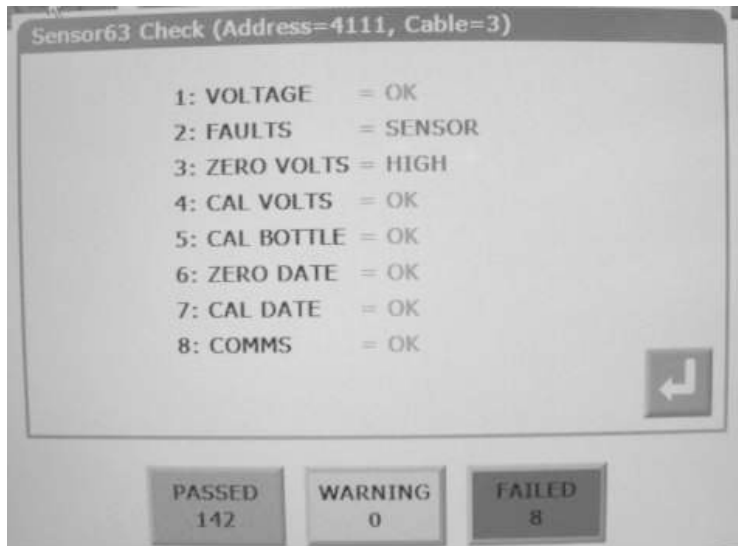

Once the test run is complete any problem detectors will be indicated as selection buttons on screen. Selecting a problem detector from the screen menu then displays the individual sensor test results as previously discussed.

## Sensor Diagnostic Functions.....Diagnostics

The sensor diagnostics function provides a snapshot of an individual sensor channel for evaluation should there be a problem. The screen shot below is indicative of the information typically available.

**The Live Data Panel**

Conc     *Live gas concentration from the detector*  
 Volts    *Gas reading as a voltage from the detector*  
 Pink     *Only for pellistors, the active volts signal*  
 Fault    *Any reported errors*  
 Errors    *Percentage communication error rate*  
 Tx        *Total number of data requests*  
 Rx        *Total number of data replies*  
 Rx t.Out *Number of time outs (no data reply from detector)*  
 Rx FEC   *Number of corrupt data packets received*

Zero Detector Routine (see Zero section)

Calibrate Detector Routine (see Calibrate section)

Sensor1 Tag = LOC1 HC 4101 Fluid Import

Live Data			
Conc	= -2.4%Lel	Fault	= None
Volts	= 0.89V	Errors	= 0.00%
Pink	= 2.20V	Tx	= 37189
		Rx	= 37189
		Rx T.Out	= 0
		Rx FEC	= 0

Calibration Data	
Zero Volts	= 0.99V
Cal Volts	= 1.79V
Zero Date	= 21/12/09
Cal Date	= 21/12/09

Settings		
Type	= T106P	Address = 4101
Range	= 100	Cable = 1
Gas	= FLAM	Software = V1.03
		Serial No: = 1
		Prod Date = 17/12/09

← 1 →

ZERO    CAL

ZERO POT	CAL Pot
57	197
Drive Pot	Bottle
25	50
Sensor Check	Set Cal Defaults

EXIT

Channel Navigation

Detector zero and calibration sensitivity functions and calibration gas settings. These should only be accessed by trained and competent personnel.

EXIT to main menu

Sensor Health Check

**Settings Data Panel (information only)**

Type        *Detector Type*  
 Range     *Detector Range*  
 Gas        *Detector Target Gas*  
 Address    *Detector Address*  
 Cable     *Cable on which detector is installed (highway)*  
 Software   *Detector Software Version*  
 Serial No   *Detector Serial Number*  
 Prod Date   *Detector Production date*

**Calibration Data Panel (information only)**

Zero Volts   *Recorded Zero Voltage from last successful zero normally 1.0V +/-0.1V*  
 Zero Date   *Date of last successful zero*  
 Cal Volts    *Recorded Cal Voltage from last successful calibration. Note this is proportional to the gas value and range of detector. For example zero = 1V Half Scale = 1.75V Full Scale = 3.5V (approx values)*  
 Cal Date     *Date of last successful calibration*



## The Relays Tab

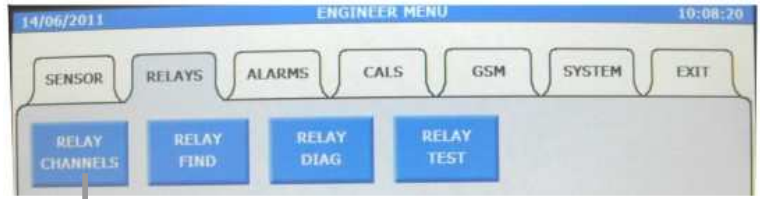

## The Relay Channels Function

Select the relay channels option to set the number of active relays on the system

## The Relay FIND Function

This function is similar to the sensor FIND function and is used to detect addressable relays installed onto the data highways. The opening screen allows you to limit which highways (cable numbers) you wish to search over and limit the range of addresses. Selecting FIND initiates the search for the selections you have made.

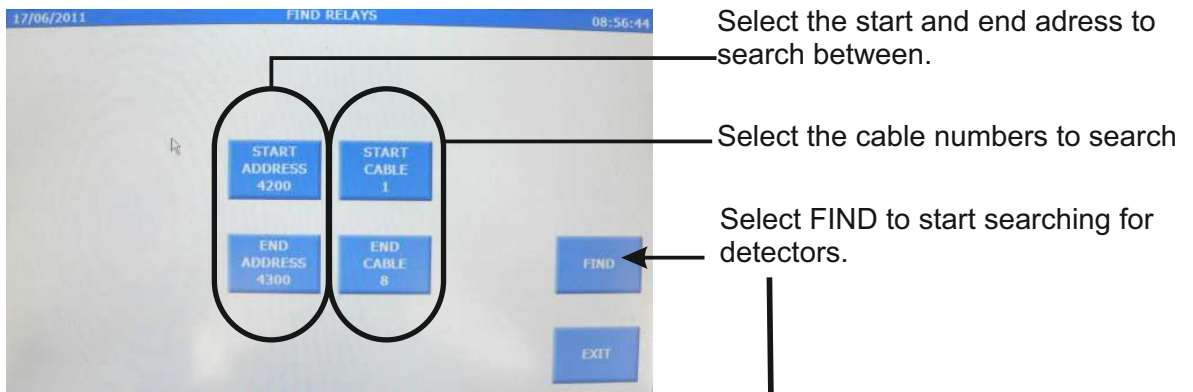

Addressable relays that have been detected are indicated against their highway (cable) number.

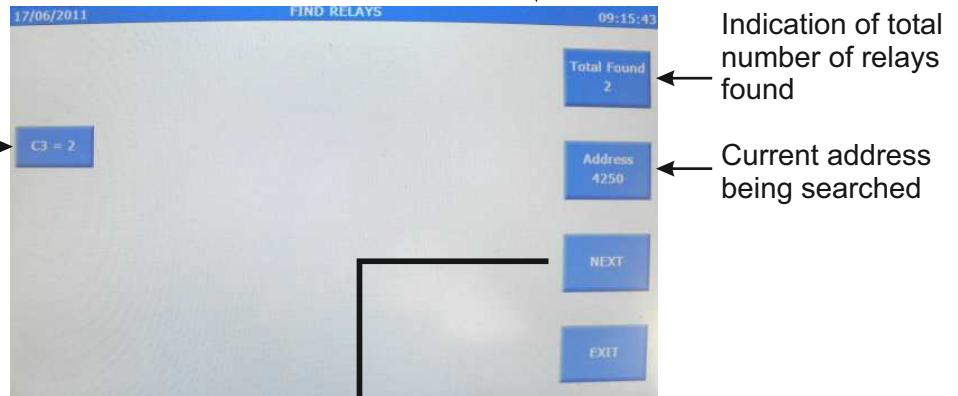

When the search is complete the NEXT button appears

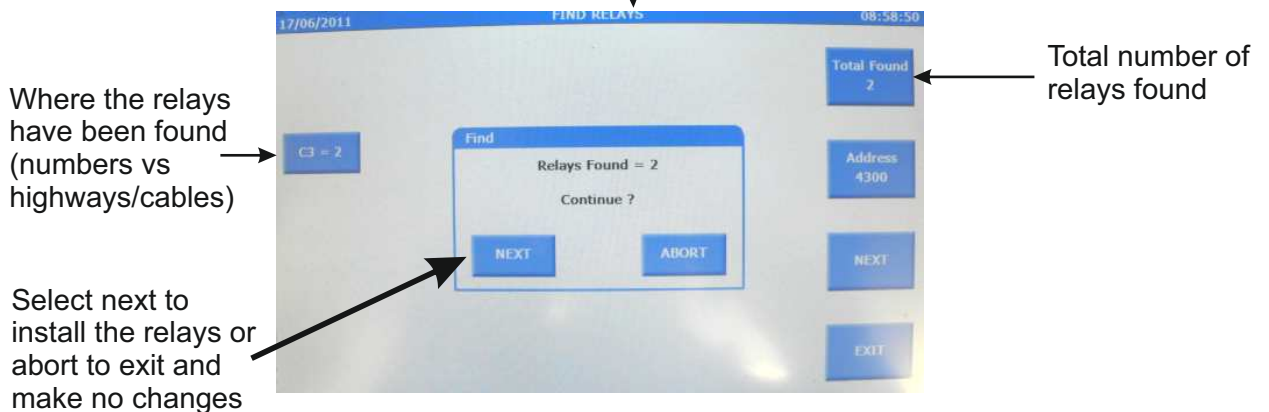

## The Relay Diagnostics Function

Current relay address and highway (cable) on which it is located

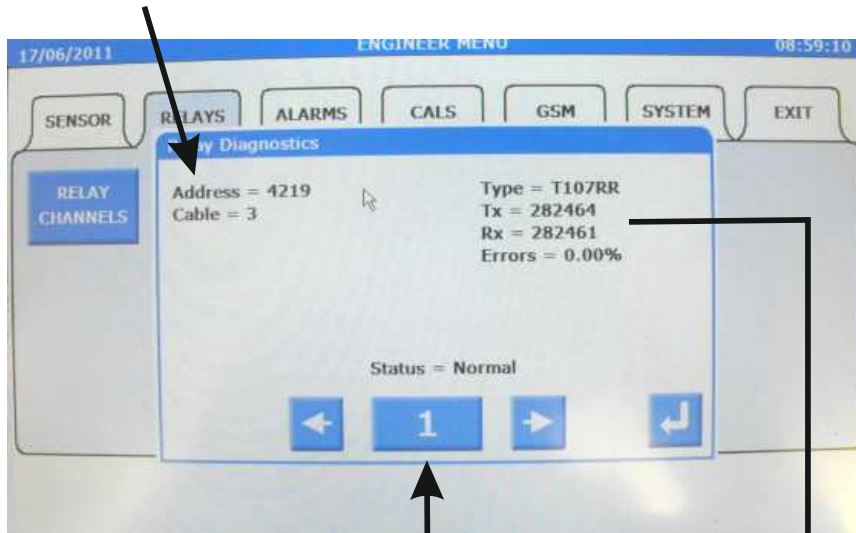

Select the relay number you wish to diagnose. Note that relay numbers (1 to x) are set up against addresses (eg 4200) in the order they are found or in the relay channels menu.

For the selected relay the diagnostic report indicates:

The relay type: T107RR Tocsin 107 2 channel relay only module  
 T107RAB Tocsin 107 2 channel I/O module  
 T920R Tocsin 920 8 channel relay module

TX: Number of data requests  
 RX: Number of data replies  
 Errors: Errors TX:RX Expressed as a percentage

## Relay Test Function

The Tocsin 920 has the option to run a relay test function. Select the option and the following screen is displayed.

Select the relay to test to see it change its state

Note the relays address is indicated



Use EXIT to return to the main menu and release all selected relays back to normal operation.

Use the NEXT and PREV buttons to select the desired relay board.  
Note an 8 way board is indicated. There are also screen displays for 107 series 2 way relay outputs.

The total number of relay boards is displayed

## The Alarms Tab

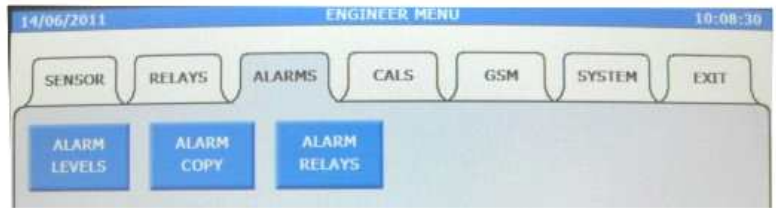

## The Alarm Levels menu

The Tocsin 920 allows 3 alarm levels to be set per sensor channel. This is set up in the alarm levels menu selection and is indicated in the screen shot shown below.

Set the alarm levels for AL1, AL2, AL3

Set alarm levels to default values

Set the alarm action for AL1, AL2, AL3  
Options are:  
Rising  
Rising Latching  
Falling  
Falling Latching

Use the arrow keys to navigate between channels or type in the channel to be edited

ESC returns the system to the menu selection screen without making any changes.

select the enter key to update your changes to the system.

Notes

## The Alarm Relay Setup Menu

The alarm relay setup on the Tocsin 920 controller is based on the relay rather than the detector/channel. For each relay output connected on the system the following set up page must be configured to allow the system to determine when a relay is triggered.

Set the alarm relay TYPE as:

- DISABLED
- AL1
- AL2
- AL3
- AL1,AL2 and AL3
- FAULT

Set the Relay Address

Set the Cable Number onto which the Relay is Installed

Set if the Relay is to be Energised or De-Energised on Alarm Activation

Set if the Relay can be Muted or not From the Control Panel

Set as Either a relay That is one of a Block of 8 or Block of 2 (Tocsin 107)

TYPE = DISABLED		Address 4200		Cable 8		Energised NO		Mutable NO		Type 8 WAY			
FROM (1)	FROM (2)	FROM (3)	FROM (4)	FROM (5)	FROM (6)	FROM (7)	TO (1)	TO (2)	TO (3)	TO (4)	TO (5)	TO (6)	TO (7)
1	0	0	0	0	0	0	0	0	0	0	0	0	0
SENSOR	SENSOR	SENSOR	SENSOR	SENSOR	SENSOR	SENSOR	SENSOR	SENSOR	SENSOR	SENSOR	SENSOR	SENSOR	SENSOR
0	0	0	0	0	0	0	0	0	0	0	0	0	0

Use the return key to save changes and the ESC key to exit without making any changes. Navigate either by typing the relay number or using the left and right keys.

Use the FROM - TO boxes to select groups of sensors, for example From sensor channel 1 To sensor channel 6 to activate this relay on alarm. Up to 7 sensor groups can be defined in this way. Note in all cases that for these groups of sensors the relay will be active only for whichever alarm level, AL1,2 or 3 is defined in the relay TYPE.

In addition to the FROM - TO sensor groups, individual channels can also be added into the relay activation definition. Up to 14 individual sensor channels can be added to the definition. Note in all cases that for these sensors channels the relay will be active only for whichever alarm level, AL1,2 or 3 is defined in the relay TYPE.

## The Calibration Menu

### 1. Sensor Zero

Select this option to Zero a particular sensor.

The expected sequence will be:

Select ZERO SENSOR function

Select the channel to ZERO

Flow zero gas at the sensor and allow to stabilise

Select to ZERO

Observe the result

See enclosed Zero-Cal Data

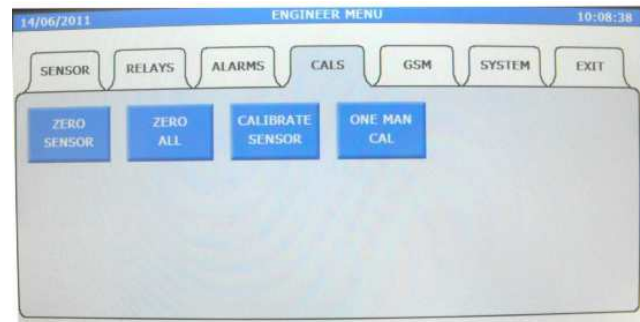

### 2. Zero All

Selecting this function will automatically perform a zero on all connected detectors. Typically this is only used during commissioning when it is known that there is no target gas present. This function should NOT be used in general calibration as there is the danger when an installation is up and running that you could be zeroing off a valid gas reading.

### 3. Calibrate Sensor

Select this option to Calibrate a particular sensor.

The expected sequence will be:

Select CALIBRATE SENSOR function

Select the channel to CALIBRATE

Flow calibration gas at the sensor and allow to stabilise

Select to CALIBRATE

Observe the result

See enclosed Zero-Cal Data

### 4. One Man Calibration

This function allows one person to calibrate a sequence of detectors by selecting the function then applying gas to each detector in turn for 3 minutes. The Tocsin 920 monitors the signal from the detectors and performs the calibration automatically once it sees a valid steady reading. This is similar in operation to the walk test function on a smoke detection panel.

For full details see later section.

### The Sensor ZERO Function

Zero and calibration functions should only be undertaken by trained competent personnel. The effectiveness of a gas detection system is largely down to how well it is maintained and this means how well it is calibrated.

Apply zero gas to the detector.

It is important that the detector zero point is correctly set. It must be considered that there is the possibility that the gas to be detected is already present in the area of the detector. For this reason never zero on just the ambient surroundings.

There are two possibilities

A. confirm there is no gas present by using a portable detector

B. Use a suitable ZERO gas as follows.

GAS	RECOMMENDED ZERO GAS
O2/CO2	NITROGEN
PELLISTOR	INSTRUMENT AIR
TOXIC GASES	NITROGEN

The following diagram shows a typical equipment set up.

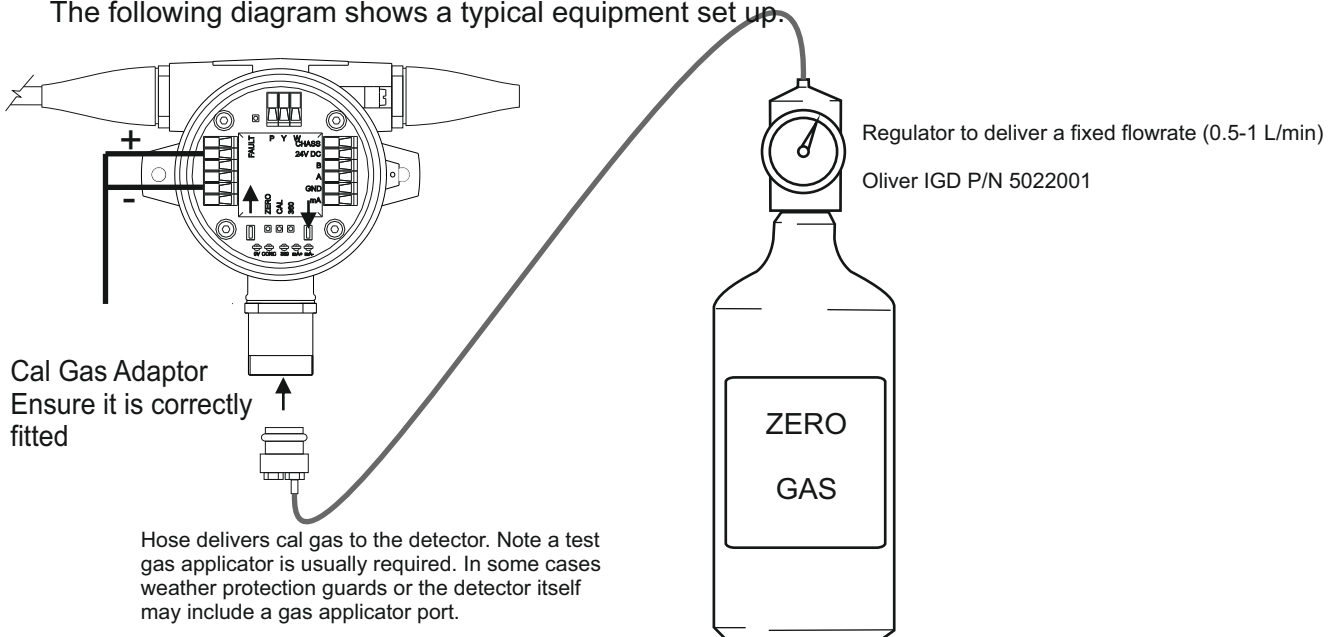

**IMPORTANT:** Flow gas for a minimum of 60 Seconds. Some detectors with longer response times may take longer to stabilise.

#### Recommended Test Gas Applicators.

Tocsin 102 Series Detector	P/N 401101A
MK3 Gas Detector	P/N 401101A
MK5 & MK6 Gas Detector	P/N 401101E
Tocsin 103 Series Detector	P/N 401101B

## The Sensor ZERO Function.....continued

Select the Zero function from the Engineers menu and the following screen is displayed.

Flow zero gas and observe the reading. Once stable select the ZERO button to send the zero command to the detector head. Observe the ZERO reading to ensure it has returned the detector to zero reading.

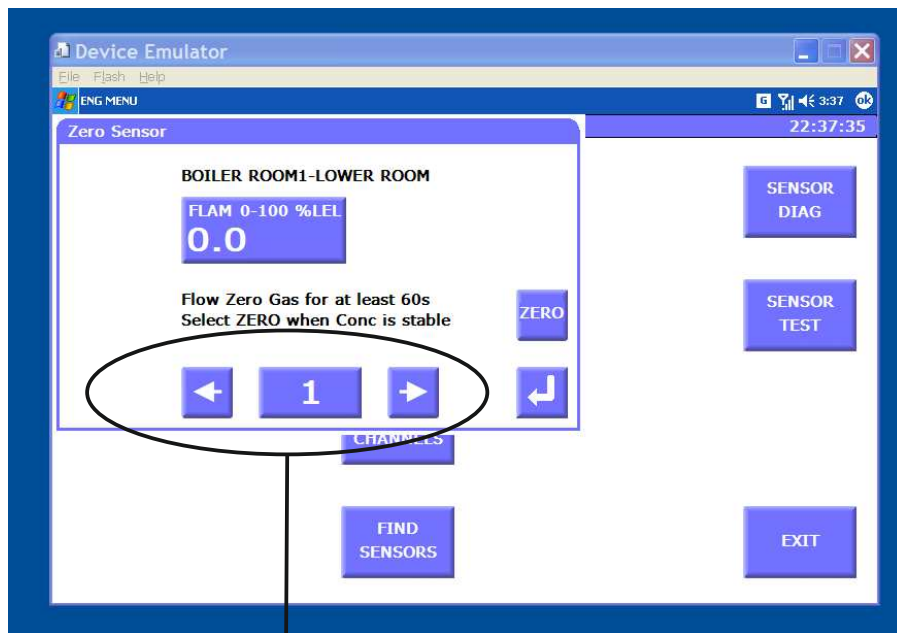

Select to move between channels. Tap on the channel number to type in the channel number if known.

Notes



## The Sensor CALIBRATE Function.....continued

Calibration is a similar process to the ZERO command and also requires a suitable calibration gas.

Note that with calibration there is more to consider than with Zeroing. The type and age of the detector can have an influence so it is recommended that periodically as well as calibrating the detectors that their response is checked in the diagnostic menu. In this manner over a period of years detector deterioration can be checked for preventative replacement. For full details refer to the IGD configurator software manual and particular detector manuals.

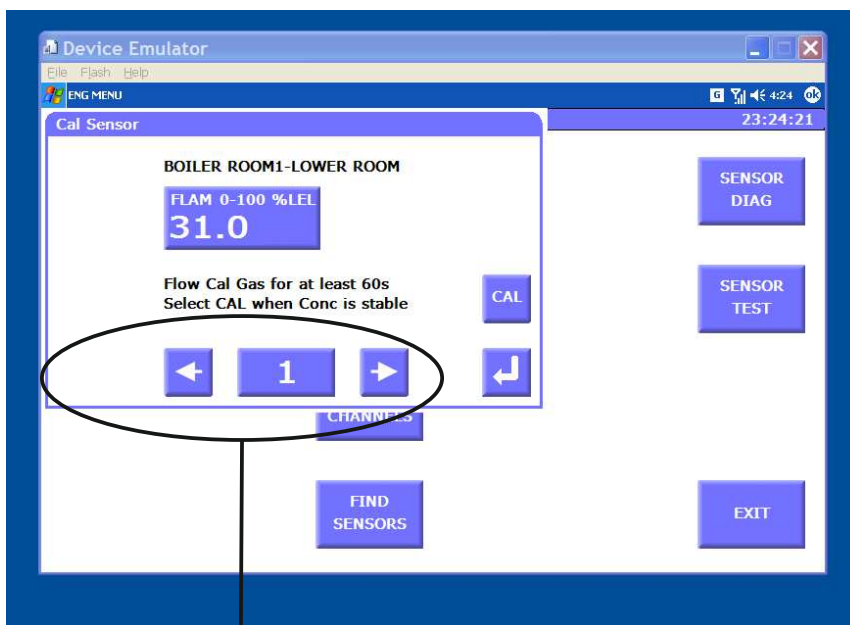
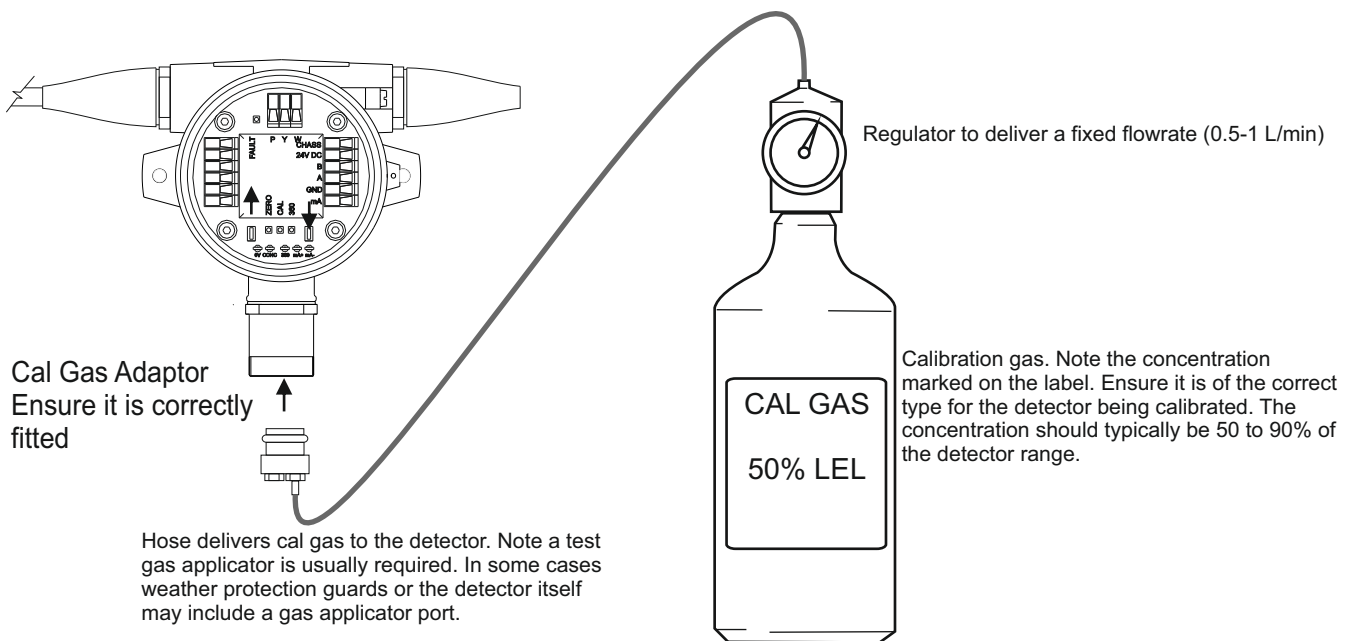

Flow calibration gas and observe the reading. Once stable select the CAL button to send the calibration command to the detector head and enter the cal gas value as requested. Observe the calibrated reading to ensure a successful calibration.

Select to move between channels. Tap on the channel number to type in the channel number if known.

## The Sensor ONE MAN CALIBRATION Function

This function allows one person to calibrate a sequence of detectors by selecting the function then applying gas to each detector in turn for 3 minutes. The Tocsin 920 monitors the signal from the detectors and performs the calibration automatically once it sees a valid steady reading. This is similar in operation to the walk test function on a smoke detection panel.

Selecting the function will display the set up screen as follows:

Calibration Gas Bottle Value (as marked on the gas bottle to be used)

The min and max concentration allows some control over what is calibrated. The settling time period is triggered once the gas value is within the min and max limits. The settle % setting then determines the bandwidth the sensor must be within during the settle time to allow calibration. If all criteria are met then the sensor will calibrate automatically

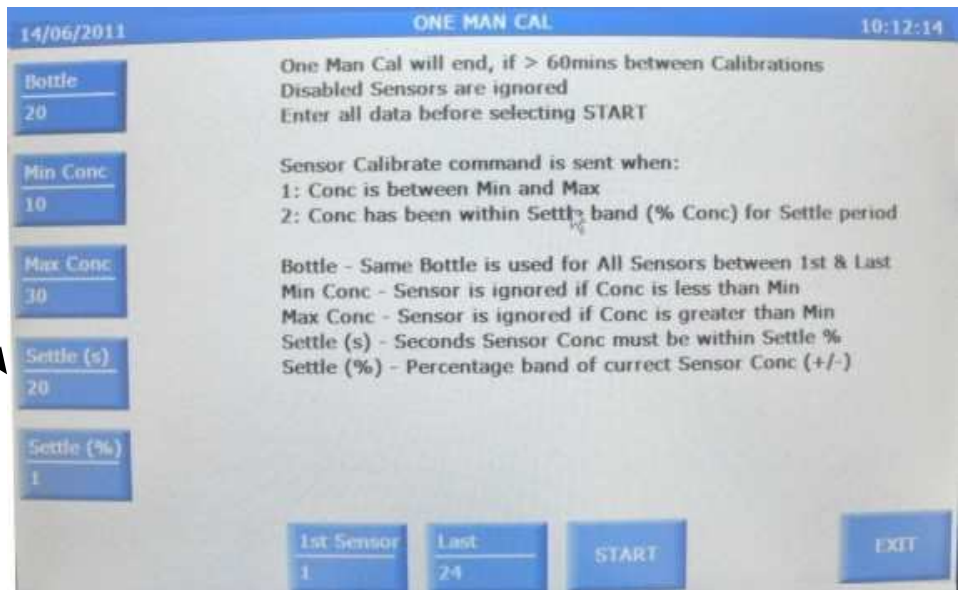

Sensor channels to include in this calibration session.

Commence calibration sequence

The following graphs indicate how the system operates. The max and min concentration settings determine when the auto calibration routine is triggered. If the settings are left wide then sensors with bigger calibration errors will be included. Such settings also mean that calibration may take longer as the system looks at the average reading after the settling time and applies the % settle setting to determine if the reading is stable enough to allow calibration. If the parameter is not met then the rolling average continues until either the criteria is met or calibration gas is removed. Settings should therefore be carefully chosen.

Typically it is advisable to set the min-max setting to be your chosen calibration accuracy for the system. For instance if you require that the system stays within +/-5% of range over a 12 month period between calibrations then for a detector range of say 100 and calibration bottle of 50 set the min-max to 45 to 55. Detectors that respond outside of this range will not be calibrated but this can be checked using the sensor check function after using the one man calibration feature. These detectors can then be interrogated separately to see why calibration has not been maintained and either replaced, re-calibrated or a more appropriate calibration period chosen.

**The Sensor ONE MAN CALIBRATION Function continued.....**

Example 1 of one man calibration setup parameters

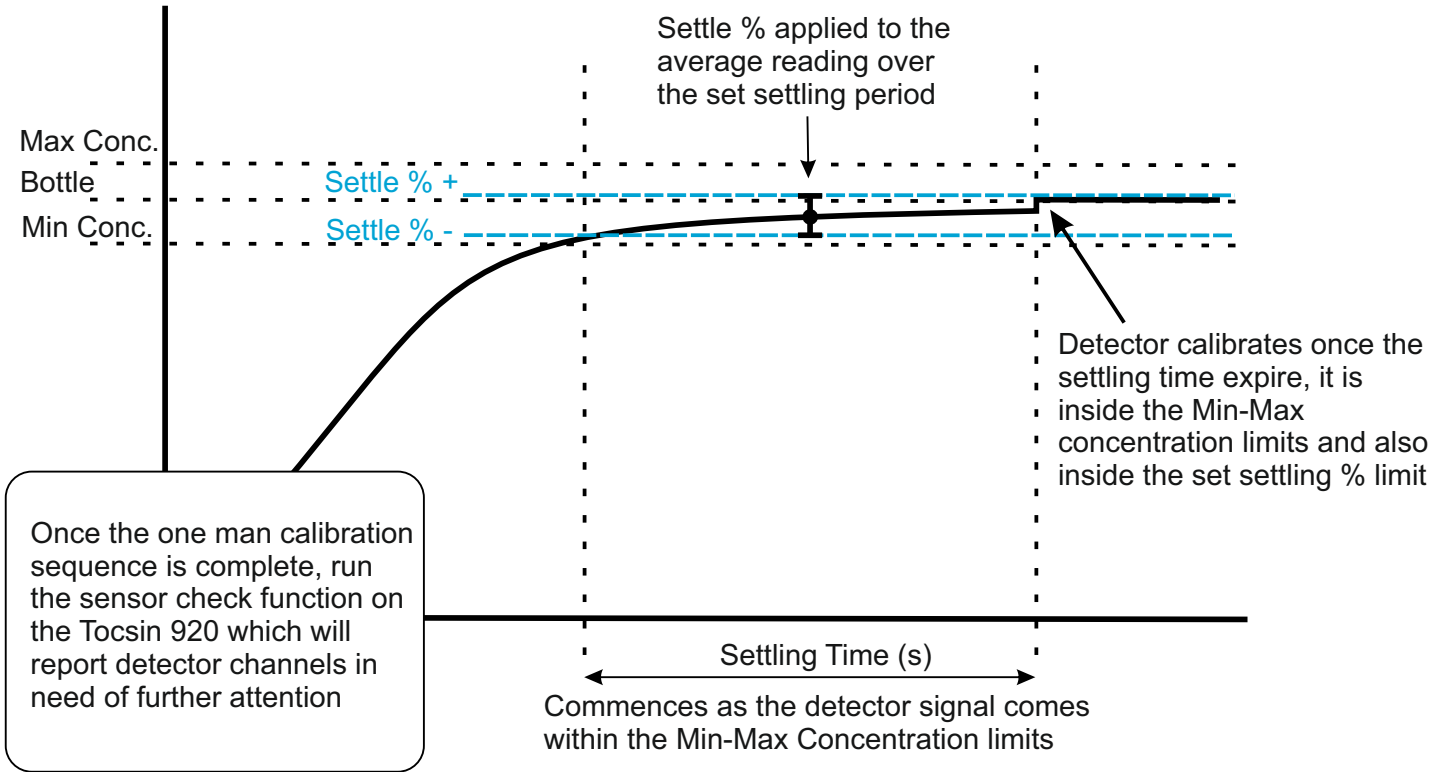

Example 2 of one man calibration setup parameters

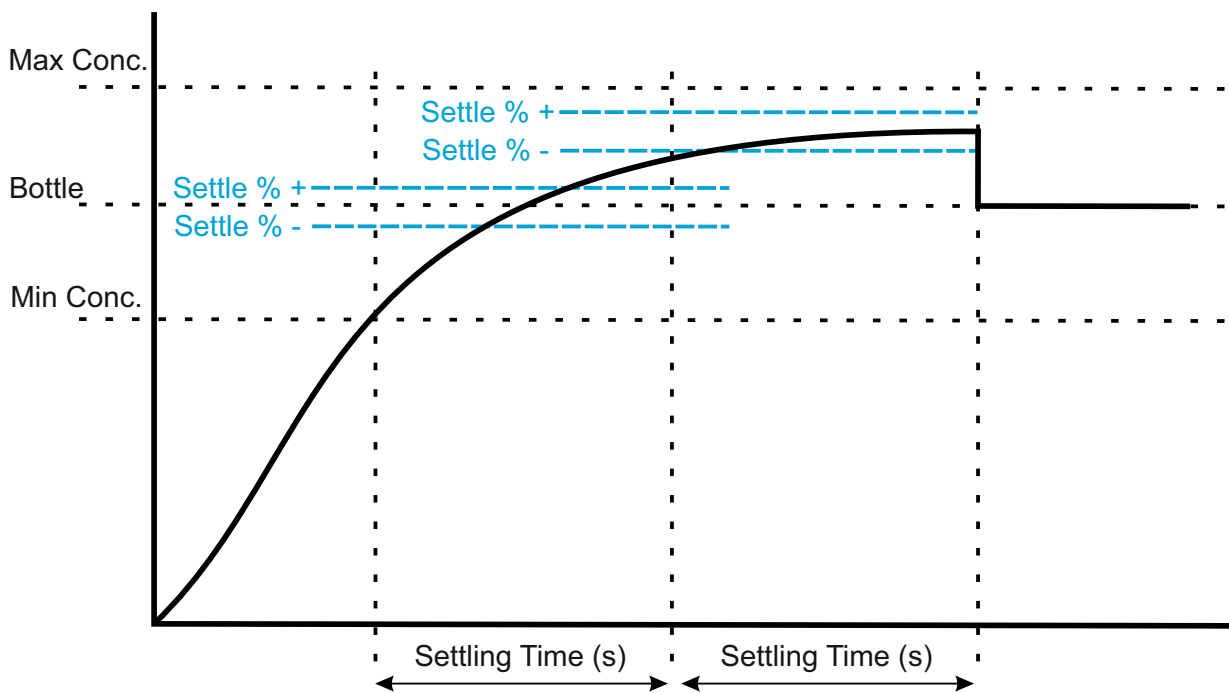

In this example the Min-Max concentrations are set quite wide to catch as many detectors as possible. At the end of the first settling period the rolling average reading is not inside the settling time % limit set so a further settling period is set, at the end of this second settling period the average detector reading is inside the set settling % limit and the detector calibrates.

Example 3 of one man calibration setup parameters

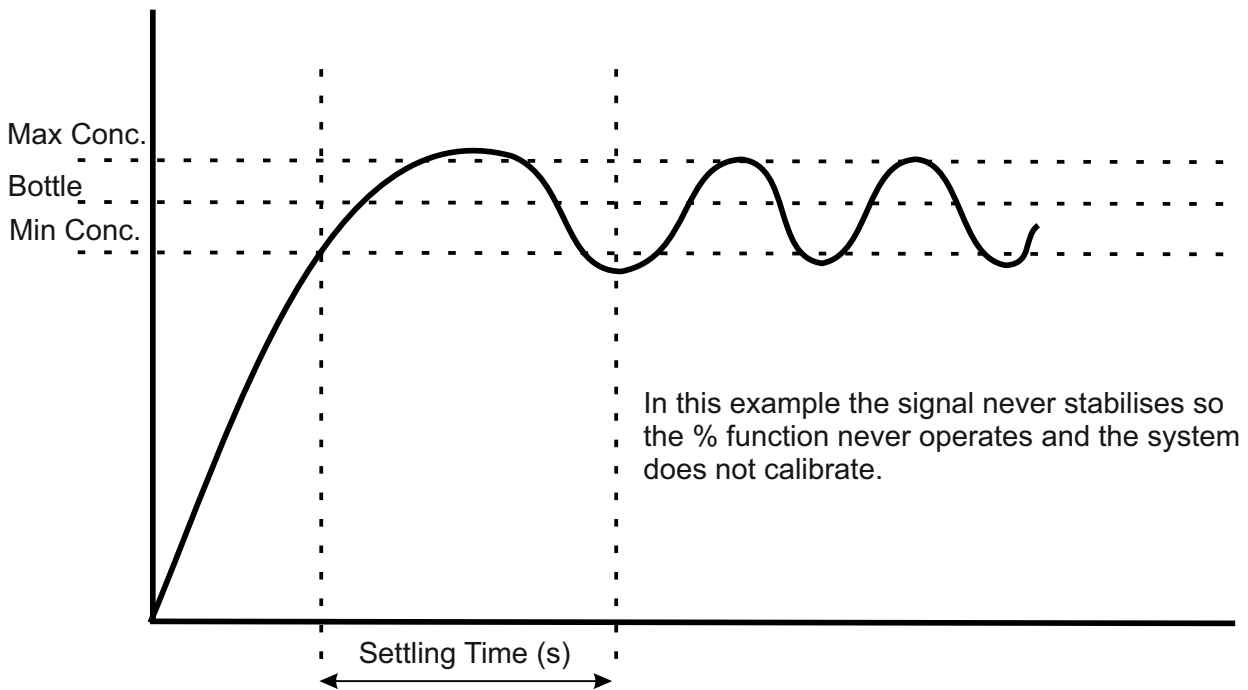

Typical screen displays during calibration.

Although the person calibrating will not see the automated actions that the Tocsin 920 undertakes during calibration anyone observing will see the following sequence taking place as gas is applied to detectors.

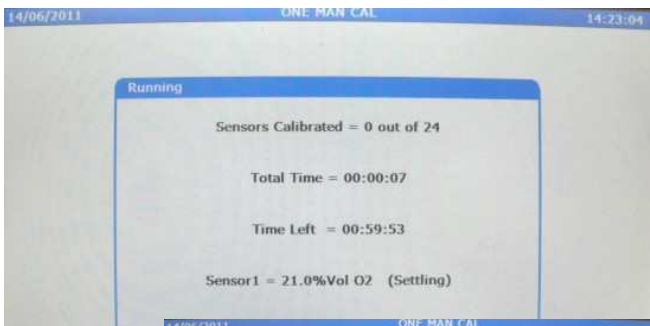

First sensor has had gas applied and is into the settling period. Time left is displayed. If gas is not applied to a sensor for more than 60 minutes then the sequence times out and the system returns to normal operation

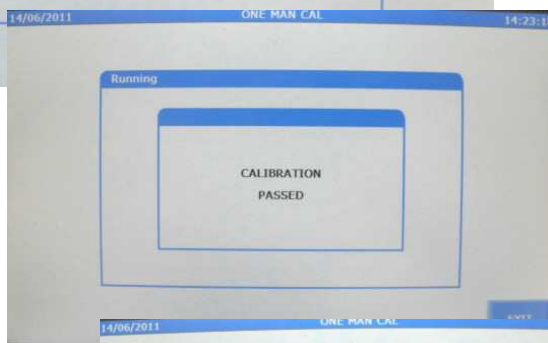

Sensor has passed calibration. The system will now wait for gas to be applied to the next sensor.

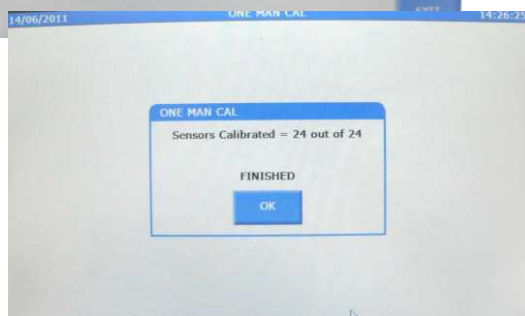

The sequence is complete and the number of calibrated sensors is displayed. The operator should check this matches the intended number of sensors and then run the sensor check function to check correct calibration and functional status.

## GSM Functions and Operation

The Tocsin 920 controllers can be fitted with a quad band GSM module. This allows remote access and reporting to and from the system.

For example weekly reports can be emailed to specified addresses from the system for such functions as the sensor check report. In that particular instance a number of responsible persons can be kept up to date as to the systems status.

By sending the correct commands reports can be triggered from the system an certain limited functions carried our remotely.

The GSM module is supplied in a wall mount enclosure pre-terminated to a 20M cable. It should be located in conjunction with the system software to obtain best signal strength.

## GSM Hardware

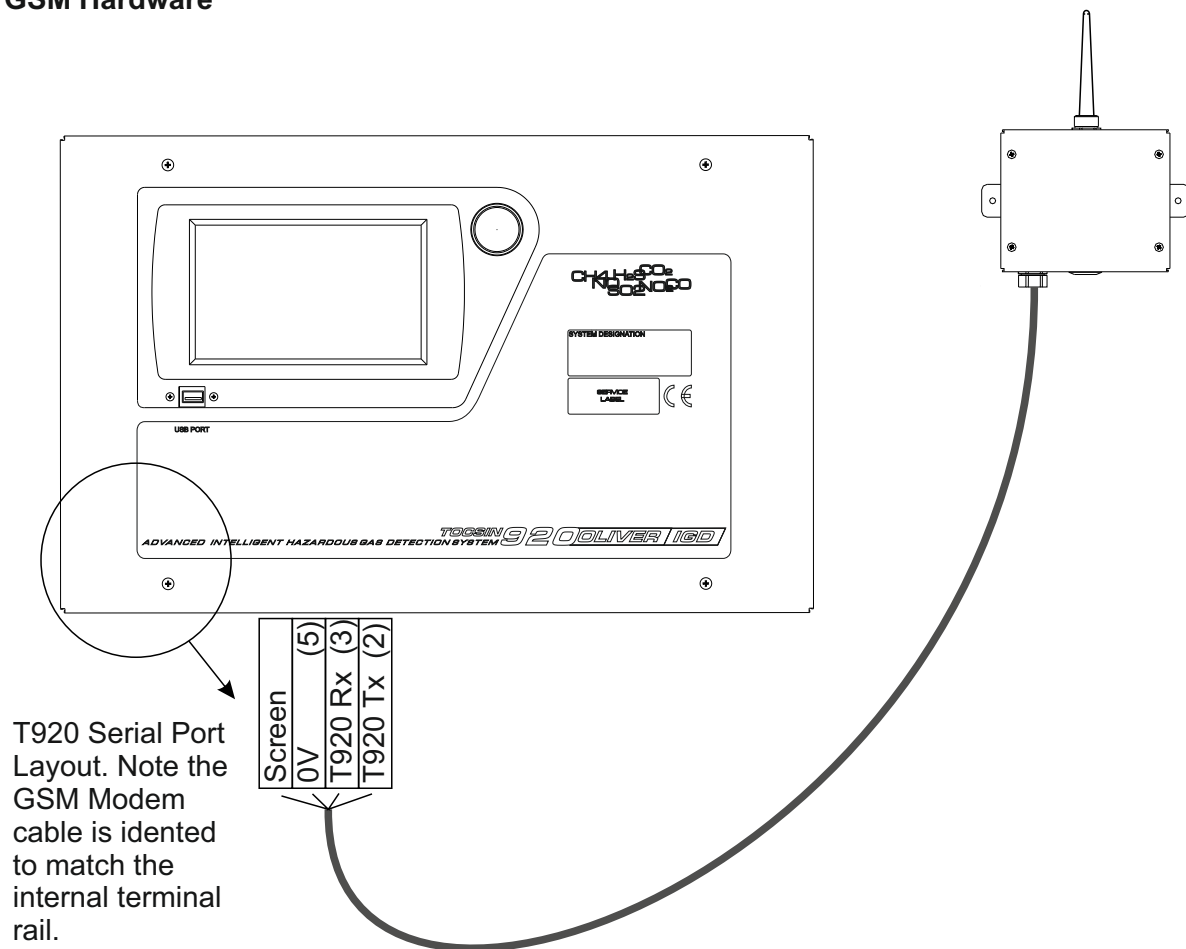

## GSM Functions Set Up

Follow this set up sequence to configure the GSM modem for operation.

Ensure the GSM module is connected as indicated in the previous drawing but do not mount until the signal strength status has been checked.

Select System Settings and ensure the Modem Option is set to ENABLED



From the GSM Tab Select GSM Test

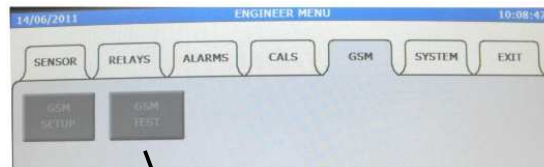

This diagnostic page provides test functions to check correct operation of the GSM module.

The options for ALARM SMS, SCHECK SMS, GAS VALUES EMAIL, EVENTS EMAIL, can be selected to send each report as selected. This requires that valid email or phone data is already set up.

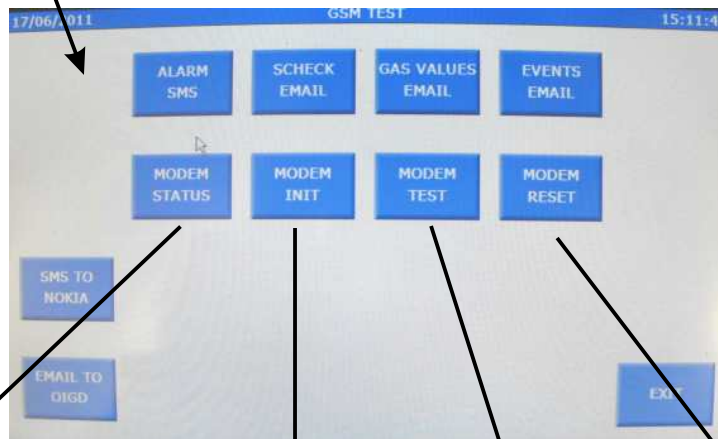

Returns information as:

```

Model Model      xxxx
Software Version xx.xx
SIM Card Number  xxxxxxxxxxxx
Phone Operator   (like Vodafone)
Registered       (yes/no)
Field Strength   (0-100%)
    
```

Note that a valid SIM card that is registered on contract is required.

Re-initialises the modem and will return a PASS or FAIL message

Performs an internal connection test 920 to modem and returns PASS/FAIL

Resets the modem and returns PASS/FAIL

## GSM Functions Set Up

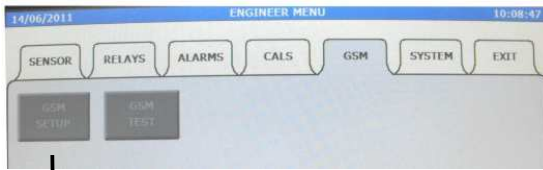

Select GSM Set up to run through the set up configuration screens as follows

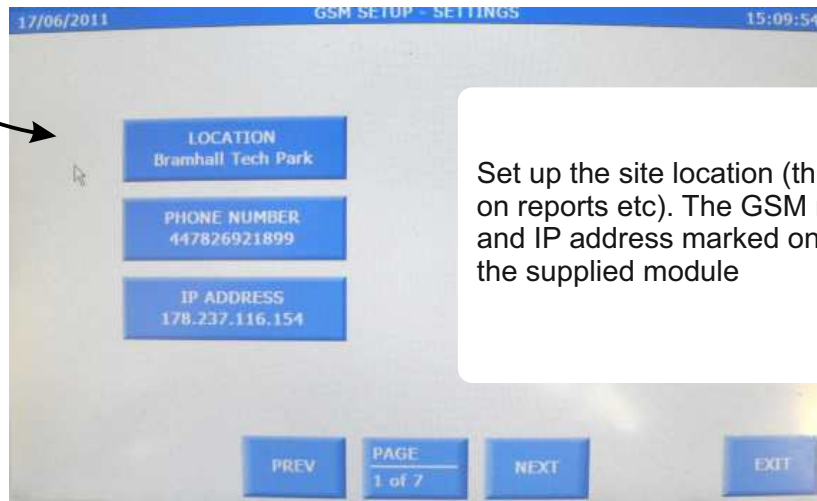

Set up the site location (this appears on reports etc). The GSM number and IP address marked on the supplied module



In set up page 2 you can set up to 5 telephone numbers for SMS alerts and 5 email addresses. Once set up these will receive any alarm or status reports requested or sent from the system.

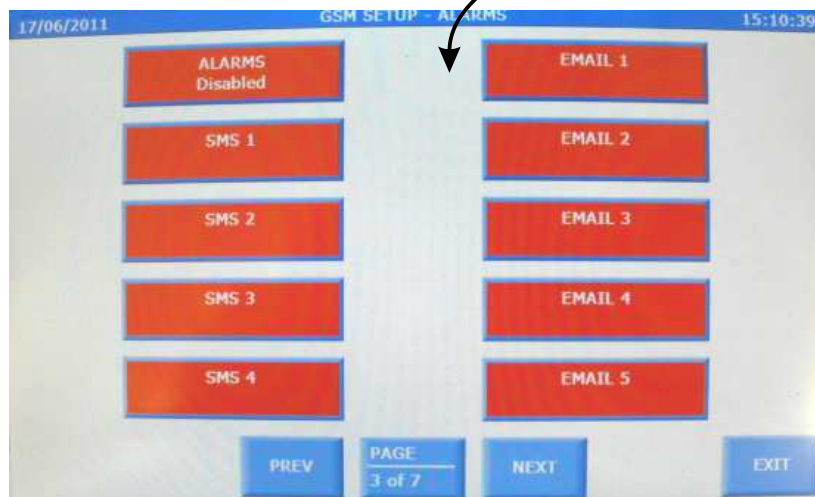

Set up page 3 allows you to determine what is sent to each email or SMS number. The button tops will stay red until a set up is configured for each address or number. selecting the button for a particular address or email account allows you to cycle through options on each button press.

## GSM Functions Set Up



Page 4 of the GSM set up determines for the system sensor check report the frequency it is run at and which email address gets the automated report at the interval set.



Page 5 of the GSM set up determines for the gas values report the frequency it is run at and which email address gets the automated report at the interval set.

The gas values report grabs a snap shot of values from each detector on the system and collates the data into a report.



Page 6 of the GSM set up determines for the Events report the frequency it is run at and which email address gets the automated report at the interval set.

The Events report collates the recorded Events stored on the panel. Events are such items as Alarms, Calibrations, Power ups etc which are all time and date stamped providing an indication of what has happened on the site.



Set up page 7 determines for the mobile phone numbers configured, which ones can access which remote command features.

Access to the remote commands requires knowledge of the sms remote command code format. This requires specialised training and is not covered in this manual

The GSM setup is now concluded and can be confirmed using the diagnostic options previously discussed.



## Saving and Re-loading the control panel setup

The Tocsin 920 system has the ability to save the complete system set up to a USB pen drive or alternately to upload a new or saved setup from a pen drive to the system.

This allows a backup of the set up to be taken and similarly if a duplicate control panel or replacement is required the set up can be quickly uploaded.

From the main screen select the Engineer Menu and enter pass code 345.

The following screen is then displayed:



Ensure the pen drive is fitted to the USB port.

Note the port supports USB 2.0

To create a backup of the Tocsin 920 set up select COPY FILES TO USB.

To upload a new set up from previously stored backup files select COPY FILES FROM USB

If a back up is successfully taken then the following three files should be on the pen drive:

T920\_Sensors.ini

T920\_Relays.ini

T920\_Settings.ini

No attempt should be made to edit these files. If files are edited incorrectly then uploaded to a new panel system errors could occur.

Only upload files to a new panel that have been downloaded from a fully operational unit.



## **Recommended control panel setup sequence.**

It is recommended to follow the set up sequence below when configuring and installing a control panel from new.

Set the Number of Required Channels. Engineers Menu .... Sensor Channels Option

Set the total number of relay outputs. Engineers Menu .... Relay Channels Option....For relay cards and 107 modules check the set addresses are as required.

Set the number of highway hubs. Engineers Menu .... System Settings Option. Set the hub addresses

Set the sensor channel alarm levels. engineers menu ... Alarm Setup Option

Set the required relay outputs. Engineer menu .... Alarm Relays Option

Follow the cable commissioning procedure T600-700-920.PDF

Perform a sensor FIND and automatically install detector data. Engineers Menu .... Find Option

Allow the system to stabilise for 2 hours and perform a global health check. Engineers menu ... . Sensor check

Following the global sensor check correct any errors and re-check.

If modems or remote access systems are to be connected follow either the GSM set up or set up Modbus addresses for the system for remote access.

Once system is demonstrated and passed of to the client run a final global sensor health check and take a backup copy of the system set up. Engineer Menu...Code 345...Copy setup to USB