

SCANIA

Steering and Suspension Catalogue



Edition 1

Introduction

Bison Parts are one of the UK fastest growing Commercial Vehicle specialists of steering, suspension and body components.

All products are new, unused and made to original equipment specification. Allowing peace of mind and easy assured fitment.

Our Steering Component range cover most major manufacturer including: Daf, Foden, Iveco, Man, Mercedes, Renault, Scania, and Volvo. We work hard to source new models and are always looking to add to our range.

Products we specialize in include: Drag links, Track Rods, Kingpin Kit, Suspension Bushes, Shackle Pins, Torque Rods, A frames, Repair Kits, Air Brake, Ball Joints, Propshaft Centre Bearing, Fuel Caps and Many More.

We pride ourselves on offering competitive prices on a wide range of quality products, while not compromising on price over quality.

We offer a next day delivery services (UK Mainland) on all orders placed before 4pm, subject to availability. So get all your products from a reliable and fast source!

For More information or extra technical help please contact us on 07792813409 where we will be pleased to help you and take your order.

*Do you run a fleet of vehicles or a small Factor Group? If so, why not contact us and see what we can do for you. If you require larger quantities then contact us for a bespoke quote.

If you can not find what you are looking for in our catalogue please contact our technical sales on the numbers below.

Contact

Tel: 07792813409

Email: sales@bisonparts.co.uk



Contents

Product Ranges	Page Ref
Drag Links / Centre Rods	3
Track Rod / Tie Bars	6
Ball Joints / Drag Link & Track Rod Ends	7
Torque Rods	9
Repair Kits	10
Centre Bearings / Propshafts	11
Universal Joints	11
Suspension Parts	12
King Pin Kits	16
Fuel Caps	17
Air Brake	18
Miscellaneous / Sundry	19
Front & Side Lighting	24
Rear Lighting	28
Slack Adjusters	29

Disclaimer

Whilst every opportunity to ensure that the information contained in this catalogue is accurate Bison Parts do not accept liability for any inaccuracies

When ordering specific parts the fitter must ensure that the replacement part is suitable for the application required, as Bison Parts does not accept any liability for incorrect fitment.

BISON REF APPLICATION OE Ref DIMENSIONS

 <p>SCDL0001</p>	2 SERIES	352635	LENGTH
	82 92 112 122 142	278663	947mm
	3 SERIES	278664	
	93 113 143		PIPE SIZE
			Ø48mm
	*Adjustable end: SCBJ0001		
	CHASSIS NUMBERS TO 1165789 & 4297218		

BISON REF APPLICATION OE Ref DIMENSIONS

 <p>SCDL0005</p>	3 SERIES	1367641	LENGTH
	93 113 143	388941	1601mm
			PIPE SIZE
			Ø40mm
	STEERING BOX TO 1ST RELAY		

 <p>SCDL0002</p>	3 SERIES	1304571	LENGTH
	93 113 143		915mm
			PIPE SIZE
			Ø50mm
	*Adjustable end: SCBJ0001		
	CHASSIS NUMBERS FROM 1165790 & 4297219		

 <p>SCDL0006</p>	3 SERIES	388942	LENGTH
	93 113 143		1150mm
			PIPE SIZE
			Ø32mm
	1ST RELAY TO 2ND RELAY AXLE TO CHASSIS NUMBERS 1185688 & 4318994		

 <p>SCDL0003</p>	3 SERIES	352637	LENGTH
	93 113 143		947mm
			PIPE SIZE
			Ø48mm
	*Adjustable end: SCBJ0001		
	MULTI LEAF SPRINGS FITTED		

 <p>SCDL0007</p>	3 SERIES	388943	LENGTH
	93 113 143		611mm
			PIPE SIZE
			Ø40mm
	*Adjustable ends: SCBJ0001		
	1ST RELAY TO 2ND RELAY AXLE TO CHASSIS NUMBERS 1185688 & 4318994		

 <p>SCDL0004</p>	3 SERIES	389867	LENGTH
	93 113 143		784mm
			PIPE SIZE
			Ø42mm
	*Adjustable end: SCBJ0001		
	STEERING BOX TO 1ST AXLE		

<p>Sorry Picture Is not available</p>	3 SERIES	1334139	LENGTH
	93 113 143		786mm
			PIPE SIZE
			Ø40mm
	*Adjustable ends:		
	1ST RELAY TO 2ND RELAY AXLE FROM CHASSIS NUMBERS 1185689 & 4318995		

BISON REF	APPLICATION	OE Ref	DIMENSIONS
SCDL0009 	4 SERIES 94 114 124 144 164	1384027 1769597	LENGTH 1059mm
	P SERIES R SERIES		PIPE SIZE Ø52mm
*Adjustable end: SCBJ0001 STEERING BOX TO THE 1ST AXLE			

BISON REF	APPLICATION	OE Ref	DIMENSIONS
SCDL0013 	4 SERIES 94 114 124 144	1343278	LENGTH 2783mm
	P SERIES R SERIES		PIPE SIZE Ø62mm
PITMAN ARM TO 1ST SWIVEL LEVER NEAR SIDE 1ST RELAY TO 2ND RELAY			

BISON REF	APPLICATION	OE Ref	DIMENSIONS
SCDL0010 	4 SERIES 94 114 124 144 164	1394884	LENGTH 439mm
	P SERIES R SERIES		PIPE SIZE Ø40mm
*Adjustable end: NEAR SIDE FRONT AJUSTABLE END IS BIGGER THAN FIXED END			

BISON REF	APPLICATION	OE Ref	DIMENSIONS
SCDL0014 	4 SERIES 94 114 124 144	1343283 1759691	LENGTH 435mm
	P SERIES R SERIES		PIPE SIZE Ø38mm
*Adjustable ends: SCBJ0002 & 0003 1ST SWIVEL LEVER TO 2ND SWIVEL LEVER NEAR SIDE 2ND RELAY TO 2ND AXLE			

BISON REF	APPLICATION	OE Ref	DIMENSIONS
SCDL0011 	4 SERIES 94 114 124 144 164	1343264 1732635	LENGTH 1921mm
			PIPE SIZE Ø60mm
NEAR SIDE 1ST RELAY TO 2ND RELAY			

BISON REF	APPLICATION	OE Ref	DIMENSIONS

BISON REF	APPLICATION	OE Ref	DIMENSIONS
SCDL0012 	4 SERIES 94 114 124 144 164	1343266 1759690	LENGTH 495mm
			PIPE SIZE Ø40mm
*Adjustable ends: SCBJ0001 NEAR SIDE 2ND RELAY TO 2ND AXLE			

BISON REF	APPLICATION	OE Ref	DIMENSIONS

BISON REF APPLICATION OE Ref DIMENSIONS

BISON REF APPLICATION OE Ref DIMENSIONS

 <p>SCTR0001</p>	3 SERIES	395350	LENGTH
	4 SERIES	1734020	1736mm
	5 SERIES	1397866	
	P SERIES		PIPE SIZE
	R SERIES		Ø40mm
*Adjustable ends: SCBJ0001 & SCBJ0002			

--

 <p>SCTR0002</p>	4 SERIES	1385251	LENGTH
	5 SERIES	1409918	1601mm
	P SERIES	1501030	
	R SERIES	1737683	PIPE SIZE
		1723895	Ø50mm
	1897335		
*Adjustable end: SCBJ0001			

--

 <p>SCTR0003</p>	BUS	1361416	LENGTH
	K94 K114 K124	1395614	1743mm
	P SERIES		
	R SERIES		PIPE SIZE
			Ø62mm
*Adjustable end: SCBJ0003			

--

--

--

BISON REF	APPLICATION	OE Ref	DIMENSIONS
	2 SERIES	1738381	LENGTH
	3 SERIES	1767328	120mm
	4 SERIES	283784	THREAD
	5 SERIES	395010	M30 x 1.5mm RH
	P SERIES		CONE SIZE
	R SERIES		30mm

BISON REF	APPLICATION	OE Ref	DIMENSIONS
	2 SERIES	310979	LENGTH
	3 SERIES		168mm
			THREAD
			M52 x 1.5mm RH
			CONE SIZE
			30mm

BISON REF	APPLICATION	OE Ref	DIMENSIONS
	2 SERIES	3401170	LENGTH
	3 SERIES		120mm
	4 SERIES		THREAD
	5 SERIES		M30 x 1.5mm RH
	P SERIES		CONE SIZE
	R SERIES		30mm

BISON REF	APPLICATION	OE Ref	DIMENSIONS
	3 SERIES	0325614	LENGTH
	4 SERIES	1375228	95mm
	5 SERIES		THREAD
	P SERIES		M26 x 1.5mm RH
	R SERIES		CONE SIZE
			N/A

BISON REF	APPLICATION	OE Ref	DIMENSIONS
	4 SERIES	1357674	LENGTH
	5 SERIES		150mm
	P SERIES		THREAD
	R SERIES		M30 x 1.5mm
	BUS		CONE SIZE
			30mm

BISON REF	APPLICATION	OE Ref	DIMENSIONS
	3 SERIES	1384898	LENGTH
		305320	55mm
		371452	Inner Thread
			M12 x 1.75mm RH
			Outer Thread
			M10 x 1.5mm

BISON REF	APPLICATION	OE Ref	DIMENSIONS
	2 SERIES	310980	LENGTH
	3 SERIES		168mm
			THREAD
			M52 x 1.5mm RH
			CONE SIZE
			30mm

BISON REF	APPLICATION	OE Ref	DIMENSIONS
	3 SERIES	1384897	LENGTH
		305319	55mm
		371451	Inner Thread
			M12 x 1.75mm LH
			Outer Thread
			M10 x 1.5mm

BISON REF

APPLICATION

OE Ref

DIMENSIONS

BISON REF

APPLICATION

OE Ref

DIMENSIONS

3 SERIES

350270

LENGTH

85mm

THREAD



M14 x 1.5mm LH

CONE SIZE

12mm

SCBJ0009



BISON REF	APPLICATION	OE Ref	DIMENSIONS	BISON REF	APPLICATION	OE Ref	DIMENSIONS
 <p>SCTQ0001</p>	3 SERIES	1326775	LENGTH 522mm				
	4 SERIES		PIPE SIZE Ø46mm				
*Repair Kit: SCRK0001							
 <p>SCTQ0002</p>	3 SERIES	1399180	LENGTH 568mm				
	4 SERIES	1428347	PIPE SIZE Ø46mm				
*Repair Kit: SCRK0002							
 <p>SCTQ0003</p>	4 SERIES	1379423	LENGTH 522mm				
			PIPE SIZE Ø46mm				

BISON REF	APPLICATION	OE Ref	DIMENSIONS
REPAIR KIT	3 SERIES	550806	DIAMETER
SCRK0001 	4 SERIES	1104334	Ø75mm
		639370	LENGTH
			115mm
			HOLE SIZE
			17mm

BISON REF	APPLICATION	OE Ref	DIMENSIONS
REPAIR KIT	4 SERIES		DIAMETER
SCRK0005 	5 SERIES		Ø67mm
	P SERIES		LENGTH
	R SERIES		115mm
			HOLE SIZE
			19mm

BISON REF	APPLICATION	OE Ref	DIMENSIONS
REPAIR KIT	BUS	1953248	DIAMETER
SCRK0002 	K112 K113	1104334	Ø85mm
			LENGTH
			130mm
			HOLE SIZE
			19mm

BISON REF	APPLICATION	OE Ref	DIMENSIONS

BISON REF	APPLICATION	OE Ref	DIMENSIONS
REPAIR KIT	4 SERIES	550800	DIAMETER
SCRK0003 	5 SERIES		Ø67mm
	P SERIES		LENGTH
	R SERIES		115mm
			HOLE SIZE
			17mm

BISON REF	APPLICATION	OE Ref	DIMENSIONS

BISON REF	APPLICATION	OE Ref	DIMENSIONS
REPAIR KIT	4 SERIES	550799	DIAMETER
SCRK0004 	5 SERIES	0639370	Ø92.6mm
	P SERIES	1104334	LENGTH
	R SERIES	138653	115mm
		550806	HOLE SIZE
			17mm

BISON REF	APPLICATION	OE Ref	DIMENSIONS

BISON REF	APPLICATION	OE Ref	DIMENSIONS
SCPS0001	3 SERIES	294270	Ø60/87mm W22mm H86mm
			

SCPS0002	3 SERIES 4 SERIES	1113031	Ø60/82mm W22mm H86mm
			

SCPS0003	4 SERIES	365901 0294383 1541070 345810 365901 + MORE	Ø48mm
			

SCPS0004	4 SERIES	309225 0337060 0366437	Ø57mm
			

BISON REF	APPLICATION	OE Ref	DIMENSIONS
SCPS0005	4 SERIES	1111745	Ø38mm
			

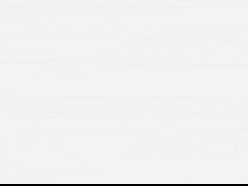
			
---	--	--	--

			
--	--	--	--

			
---	--	--	--

BISON REF	OE REF	DESCRIPTION / APPLICATION
 SCSP0001	385266	RUBBER BUFFER CAB
		2 SERIES
		3 SERIES

BISON REF	OE REF	DESCRIPTION / APPLICATION
 SCSP0007	153287	FRONT SHOCK ABSORBER (UPPER)
		REAR SHOCK ABSORBER
		(UPPER & LOWER)
		2 SERIES 3 SERIES
		Ø16mm / 56mm

BISON REF	OE REF	DESCRIPTION / APPLICATION
 SCSP0002	213604	FRONT STABILIZING BUSH
		2 SERIES
		3 SERIES
		Ø39mm x L120mm

BISON REF	OE REF	DESCRIPTION / APPLICATION
 SCSP0008	307113	FRONT SHOCK ABSORBER (UPPER)
		REAR SHOCK ABSORBER
		(UPPER & LOWER)
		2 SERIES 3 SERIES 4 SERIES
		Ø19mm / 60mm

BISON REF	OE REF	DESCRIPTION / APPLICATION
 SCSP0003	228483	FRONT STABILIZER BUSH
		2 SERIES
		3 SERIES
		4 SERIES
		Ø49mm x L100mm

BISON REF	OE REF	DESCRIPTION / APPLICATION
 SCSP0009	346085	PLASTIC BUSH
		2 SERIES
		3 SERIES

BISON REF	OE REF	DESCRIPTION / APPLICATION
 SCSP0004	1477867	STABILIZER BUSH FRONT & REAR
	310808	2 SERIES
	1429110	3 SERIES
		4 SERIES
		Ø20mm x L30mm

BISON REF	OE REF	DESCRIPTION / APPLICATION
 SCSP0010	295751	REAR STABILIZER BUSH
		3 SERIES
		Ø48mm x L96mm

BISON REF	OE REF	DESCRIPTION / APPLICATION
 SCSP0005	241922	SHOCK ABSORBER BUSH
		FRONT & REAR
		2 SERIES
		Ø21mm x L25mm

BISON REF	OE REF	DESCRIPTION / APPLICATION
 SCSP0011	1105972	CAB SUSPENSION BUSH
		3 SERIES
		Ø16.5/50mm x L66/80mm

BISON REF	OE REF	DESCRIPTION / APPLICATION
 SCSP0006	339188	SHOCK ABSORBER BUSH
		FRONT & REAR
		2 SERIES 3 SERIES
		4 SERIES
		Ø21mm x L25mm

BISON REF	OE REF	DESCRIPTION / APPLICATION
 SCSP0012	1394544	CAB SUSPENSION BUSH
	1377562	4 SERIES

	BISON REF	OE REF	DESCRIPTION / APPLICATION
	SCSP0013	1357381	CAB SHOCK ABSORBER BUSH
			4 SERIES

	BISON REF	OE REF	DESCRIPTION / APPLICATION
	SCSP0019	355145	SHACKEL PIN (*Mainly Front Pin)
		128681	2 SERIES
			3 SERIES
			4 SERIES
			M28mm x 4mm L166.5mm

	BISON REF	OE REF	DESCRIPTION / APPLICATION
	SCSP0014	1385170	CAB SUSPENSION WASHER
			4 SERIES

	BISON REF	OE REF	DESCRIPTION / APPLICATION
	SCSP0020	128680	SHACKEL BUSH (*Mainly Front Pin)
			2 SERIES
			3 SERIES
			4 SERIES
			M28 x 36mm L90mm

	BISON REF	OE REF	DESCRIPTION / APPLICATION
	SCSP0015	1481245	CAB RUBBER BUFFER
		1343134	4 SERIES

	BISON REF	OE REF	DESCRIPTION / APPLICATION
	SCSP0021	355147	SHACKEL PIN (*Mainly Rear Pin)
		135035	2 SERIES
			3 SERIES
			4 SERIES
			M36mm x 4mm L168.5mm

	BISON REF	OE REF	DESCRIPTION / APPLICATION
	SCSP0016	1349810	RUBBER BUFER CAB STOP
			4 SERIES

	BISON REF	OE REF	DESCRIPTION / APPLICATION
	SCSP0022	135036	SHACKEL BUSH (*Mainly Rear Pin)
			2 SERIES
			3 SERIES
			4 SERIES
			M36 x 46mm L90mm

	BISON REF	OE REF	DESCRIPTION / APPLICATION
	SCSP0017	1349805	CAB BUMP STOP
			4 SERIES

	BISON REF	OE REF	DESCRIPTION / APPLICATION
	SCSP0023	355148	SHACKEL PIN
		202333	2 SERIES
			3 SERIES
			4 SERIES
			M36mm x 4mm L187mm

	BISON REF	OE REF	DESCRIPTION / APPLICATION
	SCSP0018	1344190	REAR STABILIZER BAR BUSH
			4 SERIES
			Ø65mm x L104mm

	BISON REF	OE REF	DESCRIPTION / APPLICATION
	SCSP0024	135698	SHACKEL BUSH
			2 SERIES
			3 SERIES
			4 SERIES
			M36mm x 4mm L102mm

	BISON REF	OE REF	DESCRIPTION / APPLICATION
	SCSP0025	182929	SPRING O-RING
		128823	2 SERIES
			3 SERIES
			4 SERIES
			Ø36mm x Ø24mm x 6mm

	BISON REF	OE REF	DESCRIPTION / APPLICATION
	SCSP0031	1383858	WING STRAP
			4 SERIES
			5 SERIES
			P SERIES
			R SERIES

	BISON REF	OE REF	DESCRIPTION / APPLICATION
	SCSP0026	182931	SPRING O-RING
		135037	2 SERIES
			3 SERIES
			4 SERIES
			Ø44mm x Ø32mm x 6mm

	BISON REF	OE REF	DESCRIPTION / APPLICATION
	SCSP0032	285493	BUMP STOP REAR LEAF SPRING
			4 SERIES
			W28mm L103mm H45.5mm

	BISON REF	OE REF	DESCRIPTION / APPLICATION
	SCSP0027	391555	RADIATOR MOUNTING
			3 SERIES
			106 x 154 x 23

	BISON REF	OE REF	DESCRIPTION / APPLICATION
	SCSP0033	1363634	RADIATOR MOUNTING
			4 SERIES

	BISON REF	OE REF	DESCRIPTION / APPLICATION
	SCSP0028	1504160	CABIN BEARING / AIR BAG YORK
		1443114	4 SERIES
		1364293	
		1744210	

	BISON REF	OE REF	DESCRIPTION / APPLICATION
	SCSP0034	0389035	CLUTCH & BRAKE PEDEL RUBBER
			3 SERIES
			4 SERIES
			BUS

	BISON REF	OE REF	DESCRIPTION / APPLICATION
	SCSP0029	1744211	CABIN BEARING / AIR BAG YORK
		1426202	P SERIES
			R SERIES
			5 SERIES

	BISON REF	OE REF	DESCRIPTION / APPLICATION
	SCSP0035	1409889	REAR HUB OIL SEAL
			4 SERIES
			OD170mm

	BISON REF	OE REF	DESCRIPTION / APPLICATION
	SCSP0030	1336882	GEAR BOX MOUNTING
		1371225	4 SERIES

	BISON REF	OE REF	DESCRIPTION / APPLICATION
	SCSP0036	255315	SPRING EYE BOLT
			4 SERIES

	BISON REF	OE REF	DESCRIPTION / APPLICATION
	SCSP0037	0811911	SPRING EYE NUT 4 SERIES

	BISON REF	OE REF	DESCRIPTION / APPLICATION
	SCSP0043	1742449	CABIN REPAIR KIT 4 SERIES

	SCSP0038	1117830	SPRING EYE WASHER 4 SERIES

	SCSP0039	272449	SPRING EYE WASHER 4 SERIES

	SCSP0040	1382507	TIE ROD STEP 4 SERIES

	SCSP0041	237884	BUMP STOP REAR LEAF SPRINGS 4 SERIES
			H45mm, 102mm x 55mm

	SCSP0042	1324366	BUMP STOP FRONT PARABOLIC LEAF SPRINGS 4 SERIES



BISON REF	OE REF	DESCRIPTION / APPLICATION
SCKP001	550730	KING PIN KIT *WITH BEARING
	550729	3 SERIES
		L215mm Ø44.5mm / 55mm

BISON REF	OE REF	DESCRIPTION / APPLICATION
SCKP002	550257	KING PIN KIT *WITH BEARING
	550284	4 SERIES
		L223mm Ø40mm / 50mm

BISON REF

APPLICATION

OE Ref

DIMENSIONS

BISON REF

APPLICATION

OE Ref

DIMENSIONS

FUELCAP08



3 SERIES

308710

Ø60mm

Metal
Locking
Bayonet

FUELCAP09



3 SERIES

365565

Ø60mm

4 SERIES

1478450

Plastic
Locking
Bayonet
*With valve

FUELCAP10



4 SERIES

1432187

Ø60mm

P SERIES

1402004

Plastic

R SERIES

1369577

Locking

1369849

Screw

FUELCAP17





4 SERIES

1481301

Ø60mm

Plastic
Locking
Screw
*With Chain

	BISON REF	OE REF	DESCRIPTION / APPLICATION
	SCAB0001	1334037	SOLENOID VALVE
		1423566	3 SERIES
		1488083	4 SERIES
			P SERIES
			R SERIES

	BISON REF	OE REF	DESCRIPTION / APPLICATION
	SCAB0007	1105322	CLUTCH SERVO
		1114685	3 SERIES
		1361136	4 SERIES

	BISON REF	OE REF	DESCRIPTION / APPLICATION
	SCAB0002	1319557	SHIFT CYLINDER VALVE FOR SPLITTER TRANSMISSION (*INHIBITOR VALVE)
			3 SERIES
			4 SERIES

	BISON REF	OE REF	DESCRIPTION / APPLICATION
	SCAB0008	550464	CLUTCH SERVO REPAIR KIT FOR SCAB0007
			3 SERIES
			4 SERIES

	BISON REF	OE REF	DESCRIPTION / APPLICATION
	SCAB0003	1430545	LEVELLING VALVE
		1399776	4 SERIES
		1372512	
		4640070	

	BISON REF	OE REF	DESCRIPTION / APPLICATION
	SCAB0009	1380969	CLUTCH BOOT
			4 SERIES

	BISON REF	OE REF	DESCRIPTION / APPLICATION
	SCAB0004	0371612	CLUTCH SERVO
		1331770	2 SERIES
		575180	3 SERIES

	BISON REF	OE REF	DESCRIPTION / APPLICATION
Sorry Picture is not available	SCAB0010	1333518	KIT FOR SOLENOID VALVE
		1334096	SUITABLE FOR SCAB0001
		1338501	3 & 4 SERIES
		1364636	P SERIES
			R SERIES

	BISON REF	OE REF	DESCRIPTION / APPLICATION
	SCAB0005	1336159	CLUTCH SERVO REPAIR KIT FOR SCAB0004
		550455	
		550465	2 SERIES
			3 SERIES

	BISON REF	OE REF	DESCRIPTION / APPLICATION
	SCAB0011	1370354	SOLENOID VALVE
		1421325	3 SERIES
			4 SERIES

	BISON REF	OE REF	DESCRIPTION / APPLICATION
	SCAB0006	1367453	CLUTCH SERVO
		1421186	4 SERIES
		1469161	

	BISON REF	OE REF	DESCRIPTION / APPLICATION
	SCAB0012	1340232	SOLENOID VALVE
		1421323	3 SERIES
			4 SERIES

	BISON REF	OE REF	DESCRIPTION / APPLICATION
	SCA081	1366850	WINDOW REGULATOR - RH
		1366840	SCANIA 4 SERIES - 94 114 124 ect
		1442295	
			MANUAL

	BISON REF	OE REF	DESCRIPTION / APPLICATION
	SCA088	1358202	INTERCOOLER HOLE- OUTER WIRE
			*RED SILICONE
			SCANIA 4 SERIES - 94 114 124 ect
			Ø82/98mm L170mm

	BISON REF	OE REF	DESCRIPTION / APPLICATION
	SCA082	1366849	WINDOW REGULATOR - LH
		1366839	SCANIA 4 SERIES - 94 114 124 ect
		1442294	
			MANUAL

	BISON REF	OE REF	DESCRIPTION / APPLICATION
	SCA087	1385966	HEADER TANK / EXPANSION TANK
		1492421	SCANIA 4 SERIES - 94 114 124 ect
		1511775	

	BISON REF	OE REF	DESCRIPTION / APPLICATION
	SCA083	1525891	WINDSCREEN SPINDLE WIPER - LH
			SCANIA 4 SERIES - 94 114 124 ect

	BISON REF	OE REF	DESCRIPTION / APPLICATION
	SCA078	1406224	DOOR LOCK RH
		1789306	SCANIA 4 SERIES - 94 114 124 ect

	BISON REF	OE REF	DESCRIPTION / APPLICATION
	SCA084	1525892	WINDSCREEN SPINDLE WIPER - RH
			SCANIA 4 SERIES - 94 114 124 ect

	BISON REF	OE REF	DESCRIPTION / APPLICATION
	SCA079	1406225	DOOR LOCK LH
		1789305	SCANIA 4 SERIES - 94 114 124 ect

	BISON REF	OE REF	DESCRIPTION / APPLICATION
	SCA085	1525889	WIPER LINK ROD RH
			SCANIA 4 SERIES - 94 114 124 ect

	BISON REF	OE REF	DESCRIPTION / APPLICATION
	SCA073	1488410	DOOR HANDLE RH
		1544331	SCANIA 4 SERIES - 94 114 124 ect

	BISON REF	OE REF	DESCRIPTION / APPLICATION
	SCA086	1525890	WIPER LINK ROD LH
		1358288	SCANIA 4 SERIES - 94 114 124 ect

	BISON REF	OE REF	DESCRIPTION / APPLICATION
	SCA074	1488409	DOOR HANDLE LH
		1544330	SCANIA 4 SERIES - 94 114 124 ect

	BISON REF	OE REF	DESCRIPTION / APPLICATION
	SCA213	1375189	DIRECTIONAL INDICATOR SWITCH
		1402448	4 SERIES

	BISON REF	OE REF	DESCRIPTION / APPLICATION
	SCA219		INTERCOOLER HOLE
			*GRAY SILICONE
			3 SERIES
			Ø90mm L140mm

	SCA214	0360248	DIRECTIONAL INDICATOR SWITCH
		1358175	3 SERIES
		201725	

	SCA220	1425019	IGNITION CONNECTOR
			4 SERIES

	SCA215	1387022	IGNITION SWITCH
			9 PIN SWITCH
			3 SERIES
			4 SERIES

Sorry Picture is not available	SCA222	1523612	WIPER RELAY
		1741091	4 SERIES

	SCA216	1373190	DIRECTIONAL INDICATOR SWITCH
		1402449	C/W CRUISE CONTROL
			4 SERIES

	SCM011	1403271	FLYWHEEL
		324640	3 SERIES
			4 SERIES
			OD480mm

	SCA217	1440371	SEAT SWITCH *DRIVER SEAT
			4 SERIES

	SCM012	0393950	STARTER RING GEAR - 3 TEETH
		139625	3 SERIES
			OD480mm

	SCA218	488368	INTERCOOLER HOLE- OUTER WIRE
			*RED SILICONE
			3 SERIES
			4 SERIES
			Ø90mm L135mm

	SCA223	316640	MIRROR BRACKET RH & LH
			3 SERIES

	BISON REF	OE REF	DESCRIPTION / APPLICATION
	SCM013	393108	GEARBOX GEARSHIFT COVER
			3 SERIES

	BISON REF	OE REF	DESCRIPTION / APPLICATION
	SCM019	1105968	ACCELERATOR CABLE
			3 SERIES

	BISON REF	OE REF	DESCRIPTION / APPLICATION
	SCM014	1379952	CABIN FILTER
		1420197	4 SERIES

	BISON REF	OE REF	DESCRIPTION / APPLICATION
	SCA224	0296210	DOOR HANDLE - RH
		0356086	3 SERIES
		1306976	

	BISON REF	OE REF	DESCRIPTION / APPLICATION
	SCM015	290062	WHEEL BOLT
		397266	7/8 BSF 67mm
			3 SERIES

	BISON REF	OE REF	DESCRIPTION / APPLICATION
	SCM020	1428073	DRIVE ROD GEARBOX
		1515117	4SERIES R CAB

	BISON REF	OE REF	DESCRIPTION / APPLICATION
	SCM016	295953	WHEEL BOLT
			7/8 BSF 86mm
			3 SERIES

	BISON REF	OE REF	DESCRIPTION / APPLICATION
	SCM021	1426263	DRIVE ROD GEARBOX
		1515118	4SERIES P CAB

	BISON REF	OE REF	DESCRIPTION / APPLICATION
	SCM017	243956	WHEEL NUT
			7/8BSF
			3 SERIES

	BISON REF	OE REF	DESCRIPTION / APPLICATION
	SCM022	1379621	GEARBOX LINK ROD
			SQUARE SHAPE
			4 SERIES

	BISON REF	OE REF	DESCRIPTION / APPLICATION
	SCM018	1338238	RANGE SPEED LIMITER CABLE
			3 SERIES

	BISON REF	OE REF	DESCRIPTION / APPLICATION
	SCA080	1362071	GEAR KNOB
		1482997	4 SERIES

	BISON REF	OE REF	DESCRIPTION / APPLICATION
	SCM023	389500	STEERING BARREL & KEYS
			3 SERIES

	BISON REF	OE REF	DESCRIPTION / APPLICATION
	SCM029	1353717	IDLER WHEEL *SMOOTH
		1428940	4 SERIES
		1514086	
			OD 95mm x 32mm

	BISON REF	OE REF	DESCRIPTION / APPLICATION
	SCM024	1349840	AIR BELLOW CABIN
		1424231	4 SERIES

	BISON REF	OE REF	DESCRIPTION / APPLICATION
	SCM030	1487558	FLYWHEEL
			4 SERIES
			OD430mm

	BISON REF	OE REF	DESCRIPTION / APPLICATION
	SCM025	1381919	AIR BELLOW CABIN
		1476415	4 SERIES

	BISON REF	OE REF	DESCRIPTION / APPLICATION
	SCM031	1354395	BELT TENSIONER
		1371788	4 SERIES
		1493670	
		1776451	
		+ MORE	

	BISON REF	OE REF	DESCRIPTION / APPLICATION
	SCM026	1472771	LINK ROD DIAMOND SHAPE
			4 SERIES

	BISON REF	OE REF	DESCRIPTION / APPLICATION
	SCM032	1449287	GEARBOX MOUNTING
		1469287	
		1782737	

	BISON REF	OE REF	DESCRIPTION / APPLICATION
	SCM027	1301696	HYDRAULIC FILTER
			3 SERIES
			4 SERIES

	BISON REF	OE REF	DESCRIPTION / APPLICATION
	SCM033	1438702	GEAR KNOB
		1727377	

	BISON REF	OE REF	DESCRIPTION / APPLICATION
	SCM028	1413609	IDLER WHEEL *RIBBED
		1428941	4 SERIES
		1514087	
			OD 95mm x 34.3mm

	BISON REF	OE REF	DESCRIPTION / APPLICATION
	SCM034	1324712	OIL SEAL
			4 SERIES
			ID36mm OD52mm H7mm

	BISON REF	OE REF	DESCRIPTION / APPLICATION
	SCM035	1324713	BEARING 4 SERIES

	BISON REF	OE REF	DESCRIPTION / APPLICATION

	SCM036	1492747	RADIATOR SUSPENSION RH 4 SERIES
		1762624	

	SCM037	1492746	RADIATOR SUSPENSION LH 4 SERIES
		1762623	

	BISON REF	OE REF	DESCRIPTION / APPLICATION
	SCA010	269519	HEADLIGHT - RH
		289915	2 SERIES
		0301022701	3 SERIES

	SCA009	269520	HEADLIGHT - LH
		289916	2 SERIES
		0301022702	3 SERIES

	SCA012	1365969	INDICATOR LAMP - RH
		394767	2 SERIES
			3 SERIES

	SCA013	394766	INDICATOR LAMP - LH
			2 SERIES
			3 SERIES

	SCA014	313660	INDICATOR LENS - RH
			2 SERIES
			3 SERIES

	SCA015	313659	INDICATOR LENS - LH
			2 SERIES
			3 SERIES

	BISON REF	OE REF	DESCRIPTION / APPLICATION
	SCA190		9" (220mm) LAMP *C/W SIDE LIGHT - CLEAR
			NON-LED
			2 SERIES
			3 SERIES
			4 SERIES

	SCA191		9" (220mm) LAMP *C/W SIDE LIGHT - BLUE
			NON-LED
			2 SERIES
			3 SERIES
			4 SERIES

	SCA192		9" (220mm) LAMP *C/W SIDE LIGHT - GREEN
			NON-LED
			2 SERIES
			3 SERIES
			4 SERIES

	SCA193		9" (220mm) LED LAMP *C/W SIDE LIGHT
			- CLEAR
			LED
			2 SERIES
			3 SERIES, 4 SERIES

	SCA194		9" (220mm) LED LAMP *C/W SIDE LIGHT
			- BLUE
			LED
			2 SERIES
			3 SERIES, 4 SERIES

	SCA195		9" (220mm) LED LAMP *C/W SIDE LIGHT
			- GREEN
			LED
			2 SERIES
			3 SERIES, 4 SERIES

	BISON REF	OE REF	DESCRIPTION / APPLICATION
	SCA196		7" (175mm) LAMP *C/W SIDE LIGHT - CLEAR
			NON-LED
			2 SERIES
			3 SERIES
			4 SERIES

	SCA197		7" (175mm) LAMP *C/W SIDE LIGHT - BLUE
			NON-LED
			2 SERIES
			3 SERIES
			4 SERIES

	SCA198		7" (175mm) LAMP *C/W SIDE LIGHT - GREEN
			NON-LED
			2 SERIES
			3 SERIES
			4 SERIES

	SCA199		7" (175mm) LED LAMP *C/W SIDE LIGHT
			- CLEAR
			LED
			2 SERIES
			3 SERIES, 4 SERIES

	SCA200		7" (175mm) LED LAMP *C/W SIDE LIGHT
			- BLUE
			LED
			2 SERIES
			3 SERIES, 4 SERIES

	SCA201		7" (175mm) LED LAMP *C/W SIDE LIGHT
			- GREEN
			LED
			2 SERIES
			3 SERIES, 4 SERIES

	BISON REF	OE REF	DESCRIPTION / APPLICATION
	SCA202		DRIVING & SPOT LAMP - CLEAR
			4 SERIES

	SCA203		DRIVING & SPOT LAMP - BLUE
			4 SERIES

	SCA204		DRIVING & SPOT LAMP - GREEN
			4 SERIES

Sorry Picture Is not available	SCA205		MOUNTING BRACKET
			FOR FLUSH MOUNT LAMPS ABOVE
			4 SERIES

	SCA089	1431256	HEADLIGHT - RH
		1446588	4 SERIES
		1467003	P SERIES
		1732508	R SERIES

	SCA090	1385410	HEADLIGHT - LH
		1431257	4 SERIES
		1446587	P SERIES
		1732507	R SERIES

	BISON REF	OE REF	DESCRIPTION / APPLICATION
	SCA091	1387155	INDICATOR LAMP - RH
			4 SERIES
			P SERIES
			R SERIES
			210 x 60

	BISON REF	OE REF	DESCRIPTION / APPLICATION
	SCA098		SPOT & FOG LIGHT - LH *BLUE
			4 SERIES
			260 x 108

	BISON REF	OE REF	DESCRIPTION / APPLICATION
	SCA092	1385410	INDICATOR LAMP - LH
			4 SERIES
			P SERIES
			R SERIES
			210 x 60

	BISON REF	OE REF	DESCRIPTION / APPLICATION
	SCA094	1400209	BULB HOLDER
			USED WITH *SCA095 / 96 / 97 / 98
			4 SERIES

	BISON REF	OE REF	DESCRIPTION / APPLICATION
	SCA093	1385411	WIRING LOOM TO SUIT INDICATOR - LH & RH
		1467007	4 SERIES
		1732515	P SERIES
			R SERIES

	BISON REF	OE REF	DESCRIPTION / APPLICATION
	SCA206	1328548	FLASHER UNIT
		1401789	4 SERIES
			P SERIES
			R SERIES

	BISON REF	OE REF	DESCRIPTION / APPLICATION
	SCA095	1422992	SPOT & FOG LIGHT - RH *CLEAR
		1529071	4 SERIES
			260 x 108

	BISON REF	OE REF	DESCRIPTION / APPLICATION
	SCA159	1446354	SPOT LAMP - RH *CLEAR
		1511540	P SERIES
			R SERIES

	BISON REF	OE REF	DESCRIPTION / APPLICATION
	SCA096	1422991	SPOT & FOG LIGHT - LH *CLEAR
		1529070	4 SERIES
			260 x 108

	BISON REF	OE REF	DESCRIPTION / APPLICATION
	SCA160	1446353	SPOT LAMP - LH *CLEAR
		1511539	P SERIES
			R SERIES

	BISON REF	OE REF	DESCRIPTION / APPLICATION
	SCA097		SPOT & FOG LIGHT - RH *BLUE
			4 SERIES
			260 x 108

	BISON REF	OE REF	DESCRIPTION / APPLICATION
	SCA161	1446355	FOG LAMP - RH *CLEAR
			P SERIES
			R SERIES

	BISON REF	OE REF	DESCRIPTION / APPLICATION
	SCA162	1446356	FOG LAMP - LH *CLEAR
			P SERIES
			R SERIES

BISON REF	OE REF	DESCRIPTION / APPLICATION

	SCA163	1446354	SPOT LAMP - RH *BLUE
			P SERIES
			R SERIES

	SCA164	1446353	SPOT LAMP - LH *BLUE
			P SERIES
			R SERIES

	SCA165	1446355	FOG LAMP - RH *BLUE
			P SERIES
			R SERIES

	SCA166	1446356	FOG LAMP - LH *BLUE
			P SERIES
			R SERIES

	SCA220	0289929	FLASHER LAMP
		0334470	3 SERIES
		0365559	
		1334196	

	BISON REF	OE REF	DESCRIPTION / APPLICATION
	SCA169	1380819	LENS RH & LH
			4 SERIES
			P SERIES
			R SERIES
			510 x 125

	BISON REF	OE REF	DESCRIPTION / APPLICATION
	SCA006	1350340	REAR LAMP LH
			*WITH REG LAMP
			3 SERIES
			460 x 125

	SCA168	1371975	REAR LAMP RH
		1371978	*WITH REG LAMP, 2 STUD FIXING
		1414367	4 / P / R SERIES
		1436868	*CABLE ENTRY: UNDERSIDE DIRECT
		+ MORE	510 x 125

	SCA007	1350339	REAR LAMP LH
			*WITH REG LAMP
			3 SERIES
			460 x 125

	SCA167	1371974	REAR LAMP LH
		1371977	2 STUD FIXING
		1414366	4 / P / R SERIES
		1436867	*CABLE ENTRY: UNDERSIDE DIRECT
			510 x 125

	SCA008	1352746	REAR LENS
			3 SERIES
			460 x 125

	SCA208		REAR LAMP RH
			*WITH REG LAMP, 2 STUD FIXING
			4 / P / R SERIES
			*CABLE ENTRY: CENTRE PLUG
			473 x 116

	SCA210	345676	2 PIECE SILENT BLOCK KIT
		366006	"WITH 2 FIXING PIVOTS FOR REAR LAMPS
			4 SERIES

	SCA207		REAR LAMP LH
			*WITH REG LAMP, 2 STUD FIXING
			4 / P / R SERIES
			*CABLE ENTRY: CENTRE PLUG
			473 x 116

	SCA211		REAR LIGHT RH
			4 SERIES
			510 x 125

	SCA209	1350339	REAR LIGHT RH & LH
		1365963	"NO NUMBER PLATE LAMP
			VARIOUS
			466 x 130

	SCA212		REAR LIGHT LH
			4 SERIES
			510 x 125



To Fit:
Scania Truck and Bus
 Replaces Haldex:
72663
 Replaces OEM:
1112829
 Spline Type:
10 SAE 1-1/2" - 10c
 Control Arm:
Type 1
 Supplied with:

SCA2215 1112829, 72663, 72620, 72486 3 SERIES - ALL MODELS
 LH AXLE POSTION 1



To Fit:
Scania Truck and Bus
 Replaces Haldex:
72661
 Replaces OEM:
1112834
 Spline Type:
10 SAE 1-1/2" - 10c
 Control Arm:
Type 3
 Supplied with:

SCA2260 1112834, 72661, 72625, 72492 3 SERIES - 93, 113, 143
 RH AXLE POSTION 2 & 3

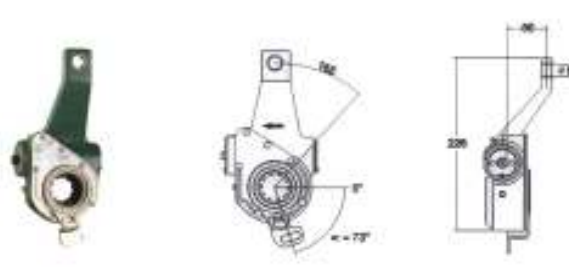

To Fit:
Scania Truck and Bus
 Replaces Haldex:
72664
 Replaces OEM:
1112830
 Spline Type:
10 SAE 1-1/2" - 10c
 Control Arm:
Type 1
 Supplied with:

SCA2210 1112830, 72664, 72621, 72487 3 SERIES - ALL MODELS
 RH AXLE POSTION 1



To Fit:
Scania Truck and Bus
 Replaces Haldex:
72727
 Replaces OEM:
394189
 Spline Type:
10 SAE 1-1/2" - 10c
 Control Arm:
Type 1
 Supplied with:

SCA2585 394189, 72727, 72529, 72483 3 SERIES - 93, 113, 143
 LH AXLE POSTION 3

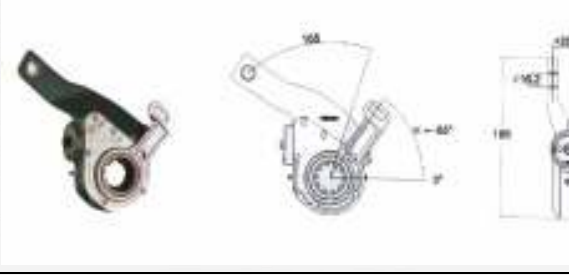

To Fit:
Scania Truck and Bus
 Replaces Haldex:
72660
 Replaces OEM:
1112833
 Spline Type:
10 SAE 1-1/2" - 10c
 Control Arm:
Type 3
 Supplied with:

SCA2220 1112833, 72660, 72624, 72491 3 SERIES - 93, 113, 143
 LH AXLE POSTION 2 & 3





To Fit:
Scania Truck and Bus
 Replaces Haldex:
72728
 Replaces OEM:
394190
 Spline Type:
10 SAE 1-1/2" - 10c
 Control Arm:
Type 1
 Supplied with:

SCA2585 394189, 72727, 72529, 72483 3 SERIES - 93, 113, 143
 RH AXLE POSTION 3

 <p>To Fit: Scania Truck Replaces Haldex: 72729 Replaces OEM: 394195 Spline Type: 10 SAE 1-1/2" - 10c Control Arm: Type 1 Supplied with: -</p>		
SCA3520	394195, 72729, 72478	3 SERIES - 93, 113, 143 LH AXLE POSTION 3

<p>Sorry Picture is not available</p>		
SCA2710	1112841, 72654, 72632, 74264	3 SERIES - 93, 113, 143 LH & RH AXLE POSTION 3

 <p>To Fit: Scania Truck Replaces Haldex: 72730 Replaces OEM: 394196 Spline Type: 10 SAE 1-1/2" - 10c Control Arm: Type 1 Supplied with: -</p>		
SCA3525	394196, 72730, 72479	3 SERIES - 93, 113, 143 RH AXLE POSTION 3

 <p>To Fit: Scania Truck and Bus Replaces Haldex: 79443 Replaces OEM: 1358635 Spline Type: 10 SAE 1-1/2" - 10c Control Arm: Type 1 Supplied with: -</p>		
SCA2740	1358635, 79443, 79034	4 SERIES - ALL MODELS LH AXLE POSITION 1

<p>Sorry Picture is not available</p>		
SCA2250	1112831, 72662, 72622, 72467	3 SERIES - 93, 113, 143 LH & RH AXLE POSTION 2 & 3

 <p>To Fit: Scania Truck and Bus Replaces Haldex: 79442 Replaces OEM: 1358634 Spline Type: 10 SAE 1-1/2" - 10c Control Arm: Type 1 Supplied with: -</p>		
SCA2735	1358634, 79442, 79033	4 SERIES - ALL MODELS RH AXLE POSITION 1

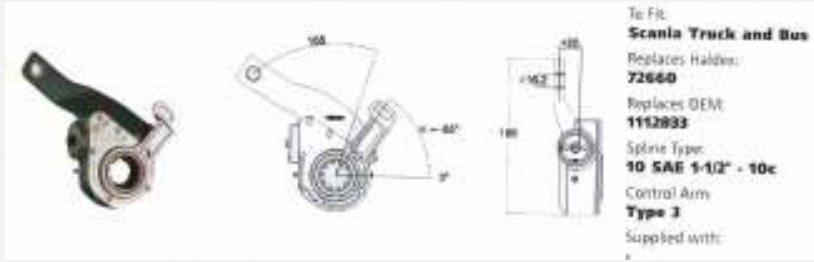

To Fit:
Scania Truck and Bus
 Replaces Haldex:
72660
 Replaces OEM:
1112833
 Spline Type:
10 SAE 1-1/2" - 10c
 Control Arm:
Type 3
 Supplied with:

SCA2220

1112833, 72660, 72624, 72491

4 SERIES - ALL MODELS
 LH AXLE POSITION 2, 3 & 4

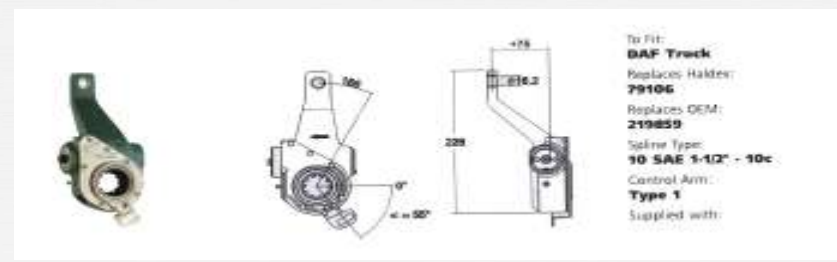

To Fit:
DAF Truck
 Replaces Haldex:
79106
 Replaces OEM:
219859
 Spline Type:
10 SAE 1-1/2" - 10c
 Control Arm:
Type 1
 Supplied with:

SCA3555

79106, 72808, 70664

4 SERIES - ALL MODELS
 RH AXLE POSITION 3 & 4

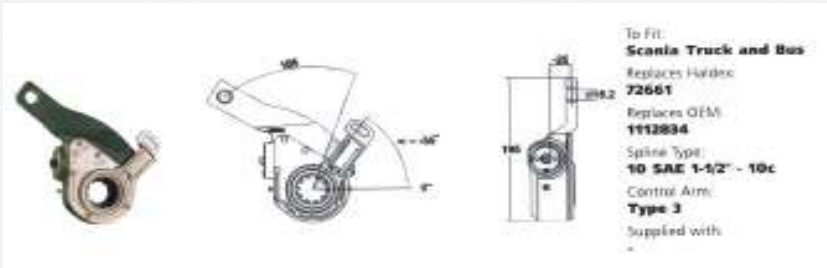

To Fit:
Scania Truck and Bus
 Replaces Haldex:
72661
 Replaces OEM:
1112834
 Spline Type:
10 SAE 1-1/2" - 10c
 Control Arm:
Type 3
 Supplied with:

SCA2260

1112834, 72661, 72625, 72492

4 SERIES - ALL MODELS
 RH AXLE POSITION 2, 3 & 4

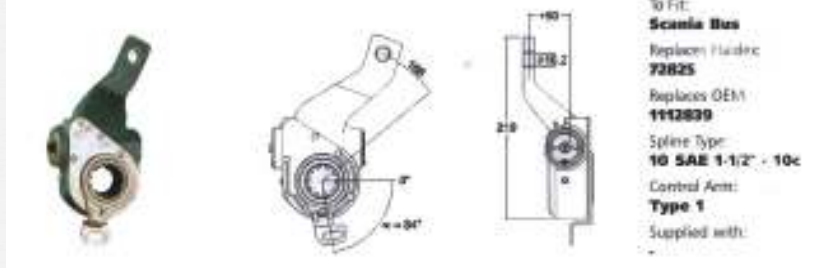

To Fit:
Scania Bus
 Replaces Haldex:
72825
 Replaces OEM:
1112839
 Spline Type:
10 SAE 1-1/2" - 10c
 Control Arm:
Type 1
 Supplied with:

SCA2360

1112839, 72825, 72630, 72488

BUS - K93, K113, L113, N113
 LH AXLE POSITION 1

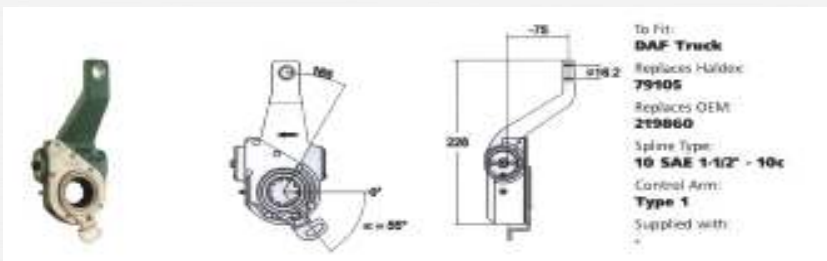

To Fit:
DAF Truck
 Replaces Haldex:
79105
 Replaces OEM:
219860
 Spline Type:
10 SAE 1-1/2" - 10c
 Control Arm:
Type 1
 Supplied with:

SCA3550

79105, 72807, 70665

4 SERIES - ALL MODELS
 LH AXLE POSITION 3 & 4

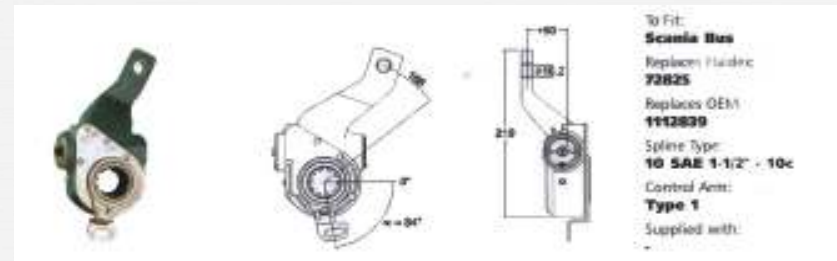

To Fit:
Scania Bus
 Replaces Haldex:
72825
 Replaces OEM:
1112839
 Spline Type:
10 SAE 1-1/2" - 10c
 Control Arm:
Type 1
 Supplied with:

SCA2595

1112840, 72826, 72631, 72489

BUS - K93, K113, L113, N113
 RH AXLE POSITION 1

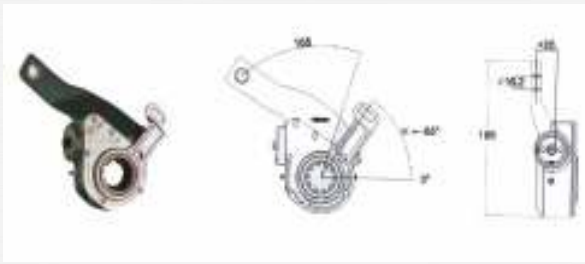

To Fit:
Scania Truck and Bus
 Replaces Haldex:
72660
 Replaces OEM:
1112833
 Spline Type:
10 SAE 1-1/2" - 10c
 Control Arm:
Type 3
 Supplied with:

SCA2220 1112833, 72660, 72624, 72491 BUS - K93, K113, L113, N113
 LH AXLE POSITION 2



To Fit:
Scania Truck and Bus
 Replaces Haldex:
72661
 Replaces OEM:
1112834
 Spline Type:
10 SAE 1-1/2" - 10c
 Control Arm:
Type 3
 Supplied with:

SCA2260 1112834, 72661, 72625, 72492 BUS - N113
 RH AXLE POSITION 3



To Fit:
Scania Truck and Bus
 Replaces Haldex:
72661
 Replaces OEM:
1112834
 Spline Type:
10 SAE 1-1/2" - 10c
 Control Arm:
Type 3
 Supplied with:

SCA2260 1112834, 72661, 72625, 72492 BUS - K93, K113, L113, N113
 RH AXLE POSITION 2

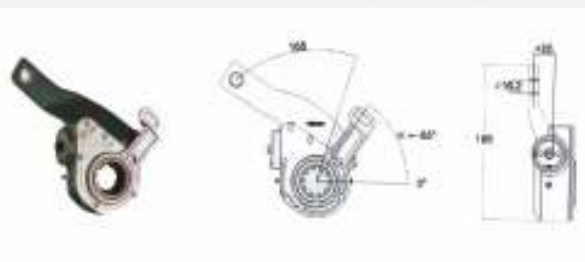
To Fit:
Scania Truck and Bus
 Replaces Haldex:
72660
 Replaces OEM:
1112833
 Spline Type:
10 SAE 1-1/2" - 10c
 Control Arm:
Type 3
 Supplied with:

SCA2220 1112833, 72660, 72624, 72491 BUS - N113
 LH AXLE POSITION 3

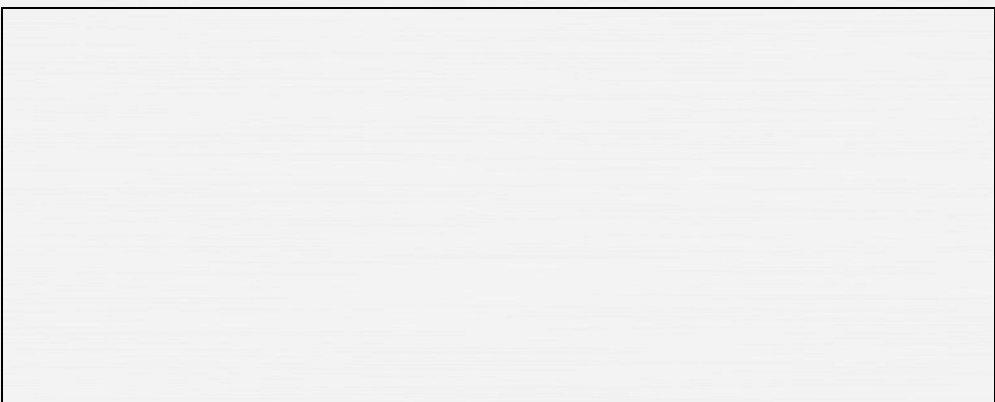

Company Address:
Bison Parts
C/O Fleet Services
Sheffield
S9 5EU

TEL: 07792813409

EMAIL: sales@bisonparts.co.uk

WWW: www.bisonparts.co.uk

