

# DAF

## Steering and Suspension Catalogue



Edition 1

# Introduction

Bison Parts are one of the UK fastest growing Commercial Vehicle specialists of steering, suspension and body components.

All products are new, unused and made to original equipment specification. Allowing peace of mind and easy assured fitment.

Our Steering Component range cover most major manufacturer including: Daf, Foden, Iveco, Man, Mercedes, Renault, Scania, and Volvo. We work hard to source new models and are always looking to add to our range.

Products we specialize in include: Drag links, Track Rods, Kingpin Kit, Suspension Bushes, Shackle Pins, Torque Rods, A frames, Repair Kits, Air Brake, Ball Joints, Propshaft Centre Bearing, Fuel Caps and Many More.

We pride ourselves on offering competitive prices on a wide range of quality products, while not compromising on price over quality.

We offer a next day delivery services (UK Mainland) on all orders placed before 4pm, subject to availability. So get all your products from a reliable and fast source!

Orders Over £150 are sent carriage FREE to UK Mainland. Orders under £150 will be charged an additional carriage amount for next day parcel service.

For items weighing under 2kg there are options to send by Royal Mail recorded from only £2.75

For More information or extra technical help please contact us on 07792813409 where we will be pleased to help you and take your order.

\*Do you run a fleet of vehicles or a small Factor Group? If so, why not contact us and see what we can do for you. If you require larger quantities then contact us for a bespoke quote.

If you can not find what you are looking for in our catalogue please contact our technical sales on the numbers below.

## **Contact**

Tel: 07792813409

Email: [sales@bisonparts.co.uk](mailto:sales@bisonparts.co.uk)



# Contents

Product Ranges	Page Ref
Drag Links / Centre Rods	4
Track Rod / Tie Bars	7
Ball Joints / Drag Link & Track Rod Ends	8
Torque Rods	12
A Frames / V Stays	12
Repair Kits	12
Centre Bearings / Propshafts	14
Suspension Parts	15
King Pin Kits	20
Fuel Caps	21
Air Brake	22
Miscellaneous / Sundry	24
Front & Side Lighting	25
Rear Lighting	27
Slack Adjusters	28
Cross Reference	33

## Disclaimer

Whilst every opportunity to ensure that the information contained in this catalogue is accurate Bison Parts do not accept liability for any inaccuracies

When ordering specific parts the fitter must ensure that the replacement part is suitable for the application required, as Bison Parts does not accept any liability for incorrect fitment.

**BISON REF APPLICATION OE Ref DIMENSIONS**

<b>DFDL0002</b> 	<b>45 EURO 2</b>	1700912	<b>LENGTH</b>
	<b>LF45</b>	1407144 AFRA498	880mm
			<b>PIPE SIZE</b>
			Ø38mm
	*Adjustable end: <b>DFBJ0006</b>		

<b>DFDL0007</b> 	<b>85</b>	1385493	<b>LENGTH</b>
	<b>75CF 85CF</b>	1257991 1351718	860mm
			<b>PIPE SIZE</b>
			Ø52mm
	*Steering Box to 1st Axle		
	*Adjustable end: <b>DFBJ0011</b>		

<b>DFDL0003</b> 	<b>LF55</b>	1405309	<b>LENGTH</b>
	<b>CF65</b>	AFRC970	925mm
			<b>PIPE SIZE</b>
			Ø45mm
	*Adjustable end: <b>DFBJ0006</b>		

<b>DFDL0008</b> 	<b>85</b>	1351745	<b>LENGTH</b>
	<b>75CF 85CF</b>	1385488 0593883 1351730	622mm
			<b>PIPE SIZE</b>
			Ø42mm
	*2nd Relay To 2nd Axle		
	*Adjustable end: <b>DFBJ0011</b>		

<b>DFDL0004</b> 	<b>65 75</b>	1283211	<b>LENGTH</b>
	<b>65CF 75CF 85CF</b>	1385497 1351714	876mm
			<b>PIPE SIZE</b>
			Ø52mm
	*Adjustable end: <b>DFBJ0011</b>		

<b>DFDL0009</b> 	<b>85</b>	1315530	<b>LENGTH</b>
	<b>75CF 85CF</b>	1283070 1283071 1351731	1673mm
			<b>PIPE SIZE</b>
			Ø52mm
	*1st Relay To 2nd Relay		

<b>DFDL0005</b> 	<b>75 85</b>	1283212	<b>LENGTH</b>
	<b>65CF 75CF 85CF</b>	1247957 1351715 1385492	848mm
			<b>PIPE SIZE</b>
			Ø52mm
	*Adjustable end: <b>DFBJ0011</b>		

<b>DFDL0010</b> 	<b>CF75 CF85</b>	1380417 1451129	<b>LENGTH</b>
			840mm
			<b>PIPE SIZE</b>
			Ø36mm
	*Adjustable end: <b>DFBJ0013</b>		

**BISON REF APPLICATION OE Ref DIMENSIONS**

<b>DFDL0011</b> 	<b>85</b>	0589943	<b>LENGTH</b>
	<b>95XF</b>		1058mm
			<b>PIPE SIZE</b>
		*2nd Relay To 2nd Axle	Ø36mm
		*Adjustable end: <b>DFBJ0015</b>	

<b>DFDL0015</b> 	<b>95</b>	0094038	<b>LENGTH</b>
		0525423	995mm
		0525433	
		0525443	<b>PIPE SIZE</b>
		0554765	Ø52mm
		*Adjustable end: <b>DFBJ0013</b>	

<b>DFDL0012</b> 	<b>85</b>	1257994	<b>LENGTH</b>
		1287409	1673mm
		1351722	
		1385509	<b>PIPE SIZE</b>
		*Steering Box To 1st Relay	Ø42mm

<b>DFDL0016</b> 	<b>95</b>	0094037	<b>LENGTH</b>
			998mm
			<b>PIPE SIZE</b>
		*Steering Box To 1st Axle	Ø42mm
		*Adjustable end: <b>DFBJ0013</b>	

<b>DFDL0013</b> 	<b>85</b>	1385490	<b>LENGTH</b>
	<b>75CF 85CF</b>	1257992	831mm
		1351732	
			<b>PIPE SIZE</b>
		*Relay To 2nd Axle	Ø36mm
		*Adjustable ends: <b>DFBJ0011 &amp; DFBJ0016</b>	

<b>DFDL0017</b> 	<b>95</b>	0071990	<b>LENGTH</b>
			1054mm
			<b>PIPE SIZE</b>
		*1st Relay To 2nd Relay	Ø40mm
		*Adjustable end: <b>DFBJ0015</b>	

<b>DFDL0014</b> 	<b>85CF</b>	1306333	<b>LENGTH</b>
	<b>XF95</b>	1351741	588mm
		1385487	
			<b>PIPE SIZE</b>
		*2nd Relay To 2nd Axle	Ø38mm
		*Adjustable end: <b>DFB00011</b>	

<b>DFDL0018</b> 	<b>95</b>	0094006	<b>LENGTH</b>
			620mm
			<b>PIPE SIZE</b>
		*2nd Relay To 2nd Axle	Ø40mm



**BISON REF APPLICATION OE Ref DIMENSIONS**

**BISON REF APPLICATION OE Ref DIMENSIONS**

<b>DFDL0019</b> 	<b>95XF</b>	1291060	<b>LENGTH</b>
		1351734	1005mm
		1385499	
			<b>PIPE SIZE</b> Ø52mm
	*Adjustable end: <b>DFBJ0011</b>		

--

<b>DFDL0020</b> 	<b>95XF</b>	1395994	<b>LENGTH</b>
	<b>XF105</b>		991mm
			<b>PIPE SIZE</b> Ø50mm
	*Adjustable end: <b>DFBJ0013</b>		

--

<b>DFDL0021</b> 	<b>95XF</b>	1311048	<b>LENGTH</b>
		1385498	998mm
		1351737	
			<b>PIPE SIZE</b> Ø36mm
	*Steering Box 1st Axle *Adjustable end: <b>DFBJ0011</b>		

--

<b>DFDL0001</b> 	<b>SB2300</b>	0094044	<b>LENGTH</b>
	<b>SB2700</b>	0274878	1130mm
	<b>SB3000</b>	1143323	
		1152427	<b>PIPE SIZE</b> Ø40mm
	*Adjustable end: <b>DFBJ0013</b>		

--

**BISON REF APPLICATION OE Ref DIMENSIONS**

**BISON REF APPLICATION OE Ref DIMENSIONS**

	<b>DFTR0002</b>	<b>LF55</b>	1270853	<b>LENGTH</b>
		<b>65CF 75CF 85CF</b>	1353391	1698mm
		<b>CF65 CF75 CF85</b>	1363391	
		<b>75 85</b>		<b>PIPE SIZE</b>
		<b>95XF</b>		Ø40mm
	<b>XF105</b>			
		*Adjustable ends: <b>DFBJ0011 &amp; DFBJ0012</b>		

--

	<b>DFTR0003</b>	<b>LF55</b>	1270854	<b>LENGTH</b>
		<b>65CF 75CF 85CF</b>	0288281	1734mm
		<b>CF65 CF75 CF85</b>	1337644	
		<b>75 85</b>		<b>PIPE SIZE</b>
		<b>95XF</b>		Ø40mm
	<b>XF105</b>			
		*Adjustable ends: <b>DFBJ0011 &amp; DFBJ0012</b>		

--

	<b>DFTR0004</b>	<b>75</b>	1286343	<b>LENGTH</b>
		<b>75CF</b>	1353396	1698mm
		<b>CF75 CF85</b>	0754922	
		<b>95XF</b>		<b>PIPE SIZE</b>
		<b>XF105</b>		Ø52mm
		*Adjustable end: <b>DFBJ0011</b>		

--

	<b>DFTR0005</b>	<b>CF85</b>	1297572	<b>LENGTH</b>
		<b>95XF</b>	1361155	1522mm
		<b>XF105</b>		
				<b>PIPE SIZE</b>
				Ø52mm
		*Adjustable end: <b>DFBJ0023</b>		

--

BISON REF	APPLICATION	OE Ref	DIMENSIONS
<b>DFBJ0001</b> 	<b>45</b>	ACU9242	<b>LENGTH</b>
	<b>F1200</b>	0110197	105mm
	<b>F1700</b>	0607451	<b>THREAD</b>
	<b>F1900</b>	0607453	M28 x 1.5mm RH
		1228114	<b>CONE SIZE</b>
		NAK9945	22mm

BISON REF	APPLICATION	OE Ref	DIMENSIONS
<b>DFBJ0005</b> 	<b>45 EURO 2</b>	AFRA888	<b>LENGTH</b>
	<b>LF45</b>		175mm
			<b>THREAD</b>
			M30 x 1.5mm RH
			<b>CONE SIZE</b>
			22mm

BISON REF	APPLICATION	OE Ref	DIMENSIONS
<b>DFBJ0002</b> 	<b>45</b>	ACU9241	<b>LENGTH</b>
	<b>F1200</b>	0110196	105mm
	<b>F1700</b>	0607452	<b>THREAD</b>
	<b>F1900</b>	067542	M28 x 1.5mm LH
		1373137	<b>CONE SIZE</b>
		NAK9946	22mm

BISON REF	APPLICATION	OE Ref	DIMENSIONS
<b>DFBJ0006</b> 	<b>45 EURO 2</b>	AFRA635	<b>LENGTH</b>
	<b>LF45</b>		115mm
			<b>THREAD</b>
			M30 x 1.5mm LH
			<b>CONE SIZE</b>
			22mm

BISON REF	APPLICATION	OE Ref	DIMENSIONS
<b>DFBJ0003</b> 	<b>45</b>	ACU9240	<b>LENGTH</b>
	<b>ROADRUNNER</b>	RAK1574	175mm
			<b>THREAD</b>
			M28 x 1.5mm RH
			<b>CONE SIZE</b>
			22mm

BISON REF	APPLICATION	OE Ref	DIMENSIONS
<b>DFBJ0007</b> 	<b>45 EURO 2</b>	AMPA346	<b>LENGTH</b>
	<b>50</b>	1689604	115mm
			<b>THREAD</b>
			M28 x 1.5mm RH
			<b>CONE SIZE</b>
			26mm

BISON REF	APPLICATION	OE Ref	DIMENSIONS
<b>DFBJ0004</b> 	<b>45</b>	ACU9239	<b>LENGTH</b>
	<b>ROADRUNNER</b>	RAK1575	175mm
			<b>THREAD</b>
			M28 x 1.5mm LH
			<b>CONE SIZE</b>
			22mm

BISON REF	APPLICATION	OE Ref	DIMENSIONS
<b>DFBJ0008</b> 	<b>45 EURO 2</b>	AMPA345	<b>LENGTH</b>
	<b>50</b>	1698605	115mm
			<b>THREAD</b>
			M28 x 1.5mm LH
			<b>CONE SIZE</b>
			26mm



BISON REF	APPLICATION	OE Ref	DIMENSIONS
<b>DFBJ0009</b> 	<b>50 60</b>	NAK3394 RLK1492	<b>LENGTH</b> 120mm <b>THREAD</b> M30 x 1.5mm RH <b>CONE SIZE</b> 28.6mm

BISON REF	APPLICATION	OE Ref	DIMENSIONS
<b>DFBJ0013</b> 	<b>CF75 CF85</b>	125890	<b>LENGTH</b> 120mm
	<b>95</b>	060981	<b>THREAD</b> M30 x 1.5mm RH
	<b>95XF</b>	0698450 160379	<b>CONE SIZE</b> 30mm

BISON REF	APPLICATION	OE Ref	DIMENSIONS
<b>DFBJ0010</b> 	<b>50 60</b>	NAK3395 RLK1493	<b>LENGTH</b> 120mm <b>THREAD</b> M30 x 1.5mm LH <b>CONE SIZE</b> 28.6mm









BISON REF	APPLICATION	OE Ref	DIMENSIONS
<b>DFBJ0014</b> 	<b>CF75 CF85</b>	0607053	<b>LENGTH</b> 120mm
	<b>95</b>	0696225	<b>THREAD</b> M30 x 1.5mm LH
	<b>95XF</b>	1228115	<b>CONE SIZE</b> 30mm

BISON REF	APPLICATION	OE Ref	DIMENSIONS
<b>DFBJ0011</b> 	<b>45 EURO 2</b>	ACHF242	<b>LENGTH</b> 115mm
	<b>LF55</b>	MAK1296	<b>THREAD</b> M30 x 1.5mm RH
	<b>50 65 75 85</b>	0586753	<b>CONE SIZE</b> 26mm
	<b>65CF 75CF 85CF</b>	0607999	
	<b>CF75 CF85</b>	0694298	
	<b>95XF</b>	1229944	
	<b>XF105</b>	1331925	

BISON REF	APPLICATION	OE Ref	DIMENSIONS
<b>DFBJ0015</b> 	<b>75CF 85CF</b>	1344684	<b>LENGTH</b> 115mm
	<b>95XF</b>	1384684	<b>THREAD</b> M24 x 1.5mm RH
			<b>CONE SIZE</b> 26mm

BISON REF	APPLICATION	OE Ref	DIMENSIONS
<b>DFBJ0012</b> 	<b>45 EURO 2</b>	ACHF241	<b>LENGTH</b> 115mm
	<b>LF55</b>	MAK1295	<b>THREAD</b> M30 x 1.5mm LH
	<b>50 65 75 85</b>	0607998	<b>CONE SIZE</b> 26mm
	<b>65CF 75CF 85CF</b>	1319838	
	<b>CF75 CF85</b>	1338714	
	<b>XF95</b>		
	<b>XF105</b>		

BISON REF	APPLICATION	OE Ref	DIMENSIONS
<b>DFBJ0016</b> 	<b>85</b>	1310760	<b>LENGTH</b> 141mm
	<b>85CF</b>	6117345	<b>THREAD</b> M30 x 1.5mm
			<b>CONE SIZE</b> 26mm

BISON REF	APPLICATION	OE Ref	DIMENSIONS	BISON REF	APPLICATION	OE Ref	DIMENSIONS
<b>DFBJ0021</b> 	LF45	1604248	<b>LENGTH</b> 145mm <b>THREAD</b> M28 x 1.5mm RH <b>CONE SIZE</b>	<b>DFBJ0026</b> 	60	PAX1458	<b>LENGTH</b> 150mm <b>THREAD</b> M48 x 1.5mm RH <b>CONE SIZE</b> 28mm
<b>DFBJ0022</b> 	LF45	1604247	<b>LENGTH</b> 145mm <b>THREAD</b> M28 x 1.5mm LH <b>CONE SIZE</b>	<b>DFBJ0027</b> 	60	PAX1459	<b>LENGTH</b> 150mm <b>THREAD</b> M48 x 1.5mm LH <b>CONE SIZE</b> 28mm
<b>DFBJ0024</b> 	LF55 65 75 85 95 65CF 75CF CF75 CF85 95XF	0067389	<b>LENGTH</b> 130mm <b>THREAD</b> M48 x 1.5mm RH <b>CONE SIZE</b>	<b>DFBJ0028</b> 	95 *N152 AXLE	1235515	<b>LENGTH</b> 133mm <b>THREAD</b> M52 x 1.5mm RH <b>CONE SIZE</b> 30mm
<b>DFBJ0025</b> 	LF55 65 75 85 95 65CF 75CF CF75 CF85 95XF	0067303	<b>LENGTH</b> 130mm <b>THREAD</b> M48 x 1.5mm LH <b>CONE SIZE</b>	<b>DFBJ0029</b> 	95 *N152 AXLE	1235514	<b>LENGTH</b> 133mm <b>THREAD</b> M52 x 1.5mm LH <b>CONE SIZE</b> 30mm

BISON REF	APPLICATION	OE Ref	DIMENSIONS
<b>DFBJ0017</b> 	<b>FA1700</b>	0608122	<b>LENGTH</b>
	<b>FA1900</b>		130mm
	<b>N122 AXLE</b>		<b>THREAD</b>
			M45 x 1.5mm RH
	<b>*Lesser Drop in arm, Castle Nut level with Bolts</b>		<b>CONE SIZE</b>
			30mm

BISON REF	APPLICATION	OE Ref	DIMENSIONS
<b>DFBJ0023</b> 	<b>55 75</b>	1320855	<b>LENGTH</b>
	<b>75CF 85CF</b>	1342026	151mm
	<b>CF75 CF85</b>	1389190	<b>THREAD</b>
	<b>95XF</b>		M30 x 1.5mm RH
	<b>XF105</b>		<b>CONE SIZE</b>
			26mm

BISON REF	APPLICATION	OE Ref	DIMENSIONS
<b>DFBJ0018</b> 	<b>FA1700</b>	0608123	<b>LENGTH</b>
	<b>FA1900</b>		130mm
	<b>N122 AXLE</b>		<b>THREAD</b>
			M45 x 1.5mm LH
	<b>*Lesser Drop in arm, Castle Nut level with Bolts</b>		<b>CONE SIZE</b>
			30mm

BISON REF	APPLICATION	OE Ref	DIMENSIONS
<b>DFBJ0030</b> 	<b>95 95XF</b>	0589333	<b>LENGTH</b>
	<b>FA1700 1900</b>	0656085	55mm RH
	<b>FA/FT 2100 2300 2500</b>	1249129	<b>INNER THREAD</b>
	<b>FA/FT 2700 2800 3300</b>		M12 x 1.75mm
	<b>FA/ FT 3600</b>		<b>OUTER THREAD</b>
			M10 x 1.5mm

BISON REF	APPLICATION	OE Ref	DIMENSIONS
<b>DFBJ0019</b> 	<b>FA1700 1900</b>	0606923	<b>LENGTH</b>
	<b>FA/FT 2100 2300 2500</b>		130mm
	<b>FA/FT 2700 2800 3300</b>		<b>THREAD</b>
	<b>N142 AXLE</b>		M45 x 1.5mm RH
	<b>*Higher Drop in arm, Castle Nuts just below level with Bolts line</b>		<b>CONE SIZE</b>
			30mm

BISON REF	APPLICATION	OE Ref	DIMENSIONS
<b>DFBJ0031</b> 	<b>95 95XF</b>	0592106	<b>LENGTH</b>
	<b>FA1700 1900</b>	0656084	55mm LH
	<b>FA/FT 2100 2300 2500</b>	1249088	<b>THREAD</b>
	<b>FA/FT 2700 2800 3300</b>		M12 x 1.75mm
	<b>FA/ FT 3600</b>		<b>CONE SIZE</b>
			M10 x 1.5mm

BISON REF	APPLICATION	OE Ref	DIMENSIONS
<b>DFBJ0020</b> 	<b>FA1700 1900</b>	0606922	<b>LENGTH</b>
	<b>FA/FT 2100 2300 2500</b>		130mm
	<b>FA/FT 2700 2800 3300</b>		<b>THREAD</b>
	<b>N142 AXLE</b>		M45 x 1.5mm LH
	<b>*Higher Drop in arm, Castle Nuts just below level with Bolts line</b>		<b>CONE SIZE</b>
			30mm

BISON REF	APPLICATION	OE Ref	DIMENSIONS
<b>DFBJ0032</b> 	<b>85CF</b>	0386930	<b>LENGTH</b>
			85mm
			<b>THREAD</b>
			M14 x 1.5mm
			<b>CONE SIZE</b>
			N/A

BISON REF	APPLICATION	OE Ref	DIMENSIONS
<b>DFTQ0001</b> 	<b>75 85</b>	1294251	<b>LENGTH</b> 606mm
	75CF 85CF CF75 CF85		<b>PIPE SIZE</b> Ø40mm
*Repair Kit: <b>DFRK0001</b>			

BISON REF	APPLICATION	OE Ref	DIMENSIONS
<b>DFRK0001</b> 	<b>75 85</b>	1321936	<b>DIAMETER</b> Ø67mm
	75CF 85CF CF75 CF85	93163617	<b>LENGTH</b> 130mm <b>HOLE SIZE</b> 19mm

BISON REF	APPLICATION	OE Ref	DIMENSIONS
<b>DFVS0001</b> 	<b>65 75 85</b>	1390932	<b>LENGTH</b> 608mm
	75CF 85CF CF75 CF85 XF95 XF105	1361651 1368270 1617096	<b>PIPE SIZE</b> Ø50mm
FA/FT 2100 2300 FA/FT 2500 2700			
*Centre Kit: <b>DFRK0004</b> Outer Kit: <b>DFRK0005</b>			

BISON REF	APPLICATION	OE Ref	DIMENSIONS
<b>DFRK0002</b> 	<b>CF65 CF75 CF85</b>	0513757	<b>DIAMETER</b> Ø67mm
	95XF XF105 95	0691709	<b>LENGTH</b> 130mm <b>HOLE SIZE</b> 21mm

BISON REF	APPLICATION	OE Ref	DIMENSIONS
<b>DFVS0002</b> 	<b>CF75 CF85</b>	1361151	<b>LENGTH</b> 550mm
	85 95 85CF XF105	0649819	<b>PIPE SIZE</b> Ø58mm
FA/FT 2100 2300 FA/FT 2500 2700			
*Centre Kit: <b>DFRK0006</b> Outer Kit: <b>DFRK0007</b>			

BISON REF	APPLICATION	OE Ref	DIMENSIONS
<b>DFRK0003</b> 	<b>FT2800 3300 3600</b>	0693778	<b>DIAMETER</b> Ø80mm
	R4		<b>LENGTH</b> 152mm <b>HOLE SIZE</b> 21mm

BISON REF	APPLICATION	OE Ref	DIMENSIONS
<b>DFVS0003</b> 	<b>CF75</b>	1361652	<b>LENGTH</b> 608mm
	85 85CF	1620436	<b>PIPE SIZE</b> Ø48mm
*Centre Kit: <b>DFRK0006</b> Outer Kit: <b>DFRK0005</b>			

BISON REF	APPLICATION	OE Ref	DIMENSIONS
<b>DFRK0008</b> 	<b>DAF BUSES</b>	1252284	<b>DIAMETER</b> Ø75mm
	85CF		<b>LENGTH</b> 130mm <b>HOLE SIZE</b> 21mm



BISON REF	APPLICATION	OE Ref	DIMENSIONS
REPAIR KIT	<b>65 75 85</b>	0069600	<b>DIAMETER</b>
<b>DFRK0004</b>	75CF 85CF	0694701	Ø60mm
	CF75 CF85	1398368	
	XF95 XF105	0691704	
	FA/FT 2100 2300		
	FA/FT 2500 2700		
*Repair kit for DFVS0001			

BISON REF	APPLICATION	OE Ref	DIMENSIONS
REPAIR KIT	<b>75 85 95</b>	0689748	<b>DIAMETER</b>
<b>DFSP0048</b>	75CF 85CF		Ø75mm
	CF75 CF85		<b>LENGTH</b>
	95XF XF95 XF105		152mm
			<b>HOLE SIZE</b>
			23mm

BISON REF	APPLICATION	OE Ref	DIMENSIONS
REPAIR KIT	<b>65 75 85</b>	0698724	<b>DIAMETER</b>
<b>DFRK0005</b>	75CF 85CF		Ø85mm
	CF75 CF85		<b>LENGTH</b>
	XF95 XF105		152mm
	FA/FT 2100 2300		<b>HOLE SIZE</b>
	FA/FT 2500 2700		23mm
*Repair kit for DFVS0001			

BISON REF	APPLICATION	OE Ref	DIMENSIONS
	<b>65 75 85 95</b>	1376730	<b>DIAMETER</b>
<b>DFSP0051</b>	65CF 75CF 85CF		Ø65mm
	95XF		

BISON REF	APPLICATION	OE Ref	DIMENSIONS
REPAIR KIT	<b>CF75 CF85</b>	0696320	<b>DIAMETER</b>
<b>DFRK0006</b>	85 95		Ø90mm
	85CF XF105		
	FA/FT 2100 2300		
	FA/FT 2500 2700		
*Repair kit for DFVS0002 & DFVS0003			

--	--	--	--

BISON REF	APPLICATION	OE Ref	DIMENSIONS
REPAIR KIT	<b>CF75 CF85</b>	0696321	<b>DIAMETER</b>
<b>DFRK0007</b>	85 95		Ø90mm
	85CF XF105		<b>LENGTH</b>
	FA/FT 2100 2300		
	FA/FT 2500 2700		<b>HOLE SIZE</b>
*Repair kit for DFVS0002			

--	--	--	--



BISON REF	APPLICATION	OE Ref	DIMENSIONS
<b>DFPS0002</b> 	<b>65 75 85 95</b>	1298157	
	<b>65CF 75CF 85CF</b> <b>F1700 1900 2300</b> <b>F2700</b>		Ø65mm W18mm HC190mm H72mm

BISON REF	APPLICATION	OE Ref	DIMENSIONS
<b>DFPS0005</b>  Sorry Picture Is not available	<b>65CF 75CF 85CF</b>	1288220	
	<b>95XF</b>	1323765 1435557	Ø65mm HC200mm

BISON REF	APPLICATION	OE Ref	DIMENSIONS
<b>DFPS0001</b> 	<b>85 95</b>	1235569	
	<b>85CF</b> <b>95XF</b> <b>DB250</b> <b>F3200 3300 3600</b>		Ø70mm W20mm HC220mm H90mm

BISON REF	APPLICATION	OE Ref	DIMENSIONS
<b>DFPS0006</b> 	<b>85CF</b>	1288231	
	<b>95XF</b> <b>CF65 CF75 CF85</b> <b>XF95</b>	1364376 1425157	Ø75mm HC220mm

BISON REF	APPLICATION	OE Ref	DIMENSIONS
<b>DFPS0004</b> 	<b>95</b>	0102204	
	<b>DB250</b> <b>F1700 1900 2100</b> <b>F2300 2500 2700</b> <b>F2800 2900 3200</b> <b>F3300 3600</b>		Ø60mm W36mm HC200mm H83mm

BISON REF	APPLICATION	OE Ref	DIMENSIONS

BISON REF	APPLICATION	OE Ref	DIMENSIONS
<b>DFPS0003</b> 	<b>F1600 1800</b>	0608924	
			Ø35mm W17mm HC168mm H60mm

BISON REF	APPLICATION	OE Ref	DIMENSIONS

PROPSHAFT KEY GUIDE: Ø = BEARING DIAMETER, W = BEARING WIDTH, HC = HOLES CENTRE DISTANCE, H = CENTRE HEIGHT

	BISON REF	OE REF	DESCRIPTION / APPLICATION
	<b>DFSP0001</b>	0299106	STABILISER BUSH
		0259524	<b>DB250</b>
		0290825	<b>65CF 75CF 85CF CF65 CF75</b>
			<b>95XF</b>
			Ø33mm x L = 66mm

	BISON REF	OE REF	DESCRIPTION / APPLICATION
	<b>DFSP0038</b>	0698429	FRONT & REAR SHOCK ABSORBER
			<b>75CF 85CF 95XF</b>
			<b>F1700 1900 2100 2300 2500 2700</b>
			<b>2800 2900 3200 3300 3600</b>
			ID24.5mm OD40/42.5 L43mm

	BISON REF	OE REF	DESCRIPTION / APPLICATION
	<b>DFSP0002</b>	0268044	REAR STABILISER BUSH
			<b>F1700 1900 65 75 85 95</b>
			<b>65CF 75CF 85CF CF75 CF85</b>
			<b>XF95 95XF XF105</b>
			ID55 OD70mm L82mm

	BISON REF	OE REF	DESCRIPTION / APPLICATION
	<b>DFSP0039</b>	0699425	FRONT & REAR SHOCK ABSORBER
			<b>65 75 85</b>
			<b>65CF 75CF 85CF 95XF</b>
			<b>F1900 F2300 2700</b>
			Ø34mm x L = 59mm

	BISON REF	OE REF	DESCRIPTION / APPLICATION
	<b>DFSP0033</b>	0538329	FRONT STABILISER BUSH
			<b>65 75 85 95</b>
			<b>65CF 75CF 85CF</b>
			<b>F1700 1900 2100 2300 2500 2700</b>
			ID42mm OD74/84mm L60mm

	BISON REF	OE REF	DESCRIPTION / APPLICATION
	<b>DFSP0032</b>	0119140	FRONT & REAR SHOCK ABSORBER
			<b>75 85 95</b>
			<b>75CF 85CF CF85 95XF</b>
			<b>F1900 2300 2500</b>
			Ø25mm x L = 26mm

	BISON REF	OE REF	DESCRIPTION / APPLICATION
	<b>DFSP0034</b>	0268045	REAR STABILISER BUSH
			<b>F1700 1900 2100 2300 2500 2700</b>
			<b>65 75 85 95 CF75 CF85</b>
			<b>65CF 75CF 85CF 95XF XF95 XF105</b>
			ID50mm OD70/82.5mm L75mm

	BISON REF	OE REF	DESCRIPTION / APPLICATION
	<b>DFSP0035</b>	0274651	REAR STABILISER BUSH
			<b>65CF 75CF 85CF</b>
			<b>75 85 95 95XF</b>
			<b>F2300 2700</b>
			ID50mm OD59/70mm L23.5mm

	BISON REF	OE REF	DESCRIPTION / APPLICATION
	<b>DFSP0036</b>	0763523	FRONT STABILISER BUSH
			<b>F1700 75 85 95</b>
			<b>75CF 85CF</b>
			<b>CF75 CF85 XF95 95XF XF105</b>
			ID50mm OD74/85mm L60mm

	BISON REF	OE REF	DESCRIPTION / APPLICATION
	<b>DFSP0003</b>	1283618	REAR STABILISER BUSH
			<b>LF55 XF105</b>
			<b>65CF 75CF 85CF 95XF</b>
			ID = 20mm x OD = 60mm x L = 59.5mm

	BISON REF	OE REF	DESCRIPTION / APPLICATION
	<b>DFSP0037</b>	0274650	FRONT & REAR STABILISER BUSH
			<b>F1700 1900 2300 2700</b>
			<b>65 75 85 95</b>
			<b>65CF 75CF 85CF 95XF</b>
			ID40mm OD60mm L24mm

	BISON REF	OE REF	DESCRIPTION / APPLICATION
	<b>DFSP0004</b>	1273279	FRONT STABILISER BUSH
			<b>LF55 XF105</b>
			<b>65CF 75CF 85CF 95XF</b>
			ID = 16mm x OD = 51.5mm x L50mm

BISON REF	OE REF	DESCRIPTION / APPLICATION
	<b>DFSP0005</b>	1396202
		CAB MOUNTING
		<b>65 75 85 95</b>
		<b>CF65</b>
		ID = 20mm x OD = 85mm x L = 24mm

BISON REF	OE REF	DESCRIPTION / APPLICATION
	<b>DFSP0011</b>	0299039
		SPRING PIN
		<b>65CF</b>
		<b>CF75 CF85 95XF</b>
		Ø25mm x L = 158mm

BISON REF	OE REF	DESCRIPTION / APPLICATION
	<b>DFSP0006</b>	1233247
		MOUNTING SNORKEL FASTENING
		<b>65 75 85</b>
		<b>65CF 75CF 85CF 95XF</b>
		M10 x 1.5mm M8 x 1.25mm L= 6.5mm

BISON REF	OE REF	DESCRIPTION / APPLICATION
	<b>DFSP0012</b>	0266411
		SPRING BUSH
		<b>65CF</b>
		<b>CF75 CF85 95XF</b>
		ID = 37mm x OD = 49mm x L = 95mm

BISON REF	OE REF	DESCRIPTION / APPLICATION
	<b>DFSP0007</b>	1328885
		METAL BUSH
		<b>65CF 85CF</b>
		Ø20mm x L = 29mm

BISON REF	OE REF	DESCRIPTION / APPLICATION
	<b>DFSP0013</b>	0361477
		RUBBER BEARING
		<b>65CF</b>
		<b>CF75 CF85 95XF</b>
		ID = 58mm x OD = 74mm x L = 17mm

BISON REF	OE REF	DESCRIPTION / APPLICATION
	<b>DFSP0008</b>	0679254
		SPRING BUSH
		<b>65CF 95</b>
		<b>CF75 CF85 95XF</b>
		ID = 31mm x OD = 39mm x L = 75.7mm

BISON REF	OE REF	DESCRIPTION / APPLICATION
	<b>DFSP0014</b>	0388486
		RUBBER MOUNTING
		<b>65CF</b>
		<b>CF75 CF85 95XF</b>
		M10 x 1.5mm L = 90mm

BISON REF	OE REF	DESCRIPTION / APPLICATION
	<b>DFSP0009</b>	0679253
		SPRING BUSH
		<b>65CF 95</b>
		<b>CF75 CF85 95XF</b>
		ID = 26mm x OD = 31mm x L = 52.5mm

BISON REF	OE REF	DESCRIPTION / APPLICATION
	<b>DFSP0018</b>	1387980
		SPRING MOUNTING
		<b>65CF</b>
		<b>75CF 85CF 95XF</b>
		Ø72mm x L = 144.5mm

BISON REF	OE REF	DESCRIPTION / APPLICATION
	<b>DFSP0010</b>	0389071
		SPRING PIN
		<b>65CF 75CF 85CF</b>
		<b>CF75 CF85 95XF</b>
		Ø26mm x L = 136mm

BISON REF	OE REF	DESCRIPTION / APPLICATION
	<b>DFSP0015</b>	0266031
		BUMP STOP
		<b>65 75 85 65CF 75CF 85CF</b>
		<b>CF75 CF85 95XF XF95</b>
		Ø65mm x L = 66mm

	BISON REF	OE REF	DESCRIPTION / APPLICATION
	<b>DFSP0019</b>	1366868	BUSH
			<b>65CF</b>
			<b>75CF 85CF</b>
			ID = 20mm x OD = 74.5mm x L = 62mm

	BISON REF	OE REF	DESCRIPTION / APPLICATION
	<b>DFSP0025</b>	1288000	STABILIZING BUSH (FRONT)
			<b>65CF</b>
			<b>75CF 85CF 95XF</b>
			ID = 39mm x OD = 69mm x L = 60mm

	BISON REF	OE REF	DESCRIPTION / APPLICATION
	<b>DFSP0020</b>	1371070	BUSH
			<b>65CF</b>
			<b>75CF 85CF</b>
			ID = 31mm x OD = 73.5mm x L = 26mm

	BISON REF	OE REF	DESCRIPTION / APPLICATION
	<b>DFSP0030</b>	0750928	SPRING PIN
			<b>CF65 CF75 CF85</b>
			Ø25mm x L = 130mm

	BISON REF	OE REF	DESCRIPTION / APPLICATION
	<b>DFSP0021</b>	1436209	CABIN BRACKET
			<b>65CF</b>
			<b>75CF 85CF</b>
			Ø30mm x L = 128mm

	BISON REF	OE REF	DESCRIPTION / APPLICATION
	<b>DFSP0027</b>	1291233	FRONT STABILISER BUSH
		1732887	<b>75CF 85CF 95XF XF95 XF105</b>
			<b>CF75 CF85 75 85 95</b>
			ID = 43mm x OD = 61.5mm x L = 60mm

	BISON REF	OE REF	DESCRIPTION / APPLICATION
	<b>DFSP0022</b>	1357764	FRONT SPRING BUSH
		029569	<b>65CF</b>
			<b>75CF 85CF 95XF</b>
			ID = 24mm x OD = 63mm x L = 86mm

	BISON REF	OE REF	DESCRIPTION / APPLICATION
	<b>DFSP0028</b>	1254641	CAP STABILIZER BUSH
			<b>75CF 85CF</b>
			ID = 26.5mm x OD = 60mm x L = 26mm

	BISON REF	OE REF	DESCRIPTION / APPLICATION
	<b>DFSP0023</b>	1368283	FRONT SPRING BUSH
			<b>65CF 75CF 85CF CF65 CF75 CF85</b>
			<b>95XF</b>
			ID = 24mm x OD = 63mm x L100mm

	BISON REF	OE REF	DESCRIPTION / APPLICATION
	<b>DFSP0029</b>	0298498	HALF BUSH
			<b>75CF 85CF</b>
			<b>85 95</b>
			Ø46.5mm x L = 80mm

	BISON REF	OE REF	DESCRIPTION / APPLICATION
	<b>DFSP0024</b>	0654792	REAR SPRING BUSH
			<b>65CF</b>
			<b>75CF 85CF 95XF</b>
			ID = 34mm x OD = 50mm x L = 144mm

	BISON REF	OE REF	DESCRIPTION / APPLICATION
	<b>DFSP0016</b>	0109860	REAR SHOCK ABSORBER BUSH
			<b>75CF 85CF 95XF</b>
			<b>95</b>
			ID = 20mm x OD = 60mm x L = 32mm





	BISON REF	OE REF	DESCRIPTION / APPLICATION
	<b>DFSP0026</b>	1314545	CAB MOUNTING
			<b>95 95XF XF95 XF105</b>
			ID = 20mm x OD = 90mm x L = 70mm

	BISON REF	OE REF	DESCRIPTION / APPLICATION
	<b>DFSP0044</b>	1290795	DAMPER VIBRATION BUSH - CAB
			<b>95 95XF</b>
			ID51mm OD84mm D8mm

	BISON REF	OE REF	DESCRIPTION / APPLICATION
	<b>DFSP0017</b>	0221342	RUBBER RADIATOR MOUNTING
			<b>95XF</b>
			M12 x 1.5mm x L = 88mm

	BISON REF	OE REF	DESCRIPTION / APPLICATION
	<b>DFSP0045</b>	0756919	DAMPER VIBRATION BUSH - CAB
		1290794	<b>95 95XF</b>

	BISON REF	OE REF	DESCRIPTION / APPLICATION
	<b>DFSP0040</b>	0366351	BUMP STOP - REAR AXLE
			<b>75CF 85CF CF75 CF85</b>
			<b>75 85 95</b>
			<b>XF95 XF105 LF55</b>
			ID65mm OD85mm L60mm

	BISON REF	OE REF	DESCRIPTION / APPLICATION
	<b>DFSP0046</b>	1266426	PLAIN BEARING MOUNTING
			BUSH - CAB
			<b>65CF 75CF 85CF</b>
			<b>65 75 85 95 XF95 XF105</b>
			ID25mm OD51mm H20.3mm

	BISON REF	OE REF	DESCRIPTION / APPLICATION
	<b>DFSP0041</b>	0268043	FRONT STABILISER BUSH
			<b>65 75 85 95</b>
			<b>CF65</b>
			ID25mm OD35/45mm L23mm

	BISON REF	OE REF	DESCRIPTION / APPLICATION
	<b>DFSP0047</b>	1271385	SEALING RING CAB SUSPENSION
		1271753	<b>65CF 75CF 85CF</b>
			<b>65 75 85 95 XF95 95XF XF105</b>
			ID48.4mm OD62mm D5.7mm

	BISON REF	OE REF	DESCRIPTION / APPLICATION
	<b>DFSP0042</b>	0096109	FRONT STABILISER BUSH
			<b>65 95</b>
			<b>65CF 75CF 85CF 95XF</b>
			ID45mm OD74/84mm L60mm

	BISON REF	OE REF	DESCRIPTION / APPLICATION
	<b>DFSP0052</b>	1401539	SPRING BUSH
		AFRB104	<b>LF45 LF45</b>
			ID16.5mm OD45mm L82mm

	BISON REF	OE REF	DESCRIPTION / APPLICATION
Sorry Picture Is not available	<b>DFSP0043</b>	0010761	STABILISER BUSH
			<b>65 75 85 95</b>
			ID40mm OD69mm L79mm

	BISON REF	OE REF	DESCRIPTION / APPLICATION
	<b>DFSP0049</b>	0295726	SILENT BLOCK STABILIZER
			BAR BUSH
			<b>65 85 95</b>
			ID20mm OD55mm L55mm



	BISON REF	OE REF	DESCRIPTION / APPLICATION		BISON REF	OE REF	DESCRIPTION / APPLICATION
	<b>DFSP0050</b>	0558864	RUBBER MOUNTING STABILIZER BAR BUSH				
			<b>75CF 85CF 95XF</b>				
			<b>65 75 95</b>				
			ID60mm OD86mm L60mm				

BISON REF	OE REF	DESCRIPTION / APPLICATION
 DFKP0009	0681706	KING PIN KIT - WHEEL SET
		<b>65 75 85 95</b>
		<b>85CF 95XF</b>
		270mm Length Ø31.5/50mm

BISON REF	OE REF	DESCRIPTION / APPLICATION
 DFKP0005	KPKW007	KING PIN KIT - WHEEL SET
	KPK007	<b>45</b> - With Old Metal Type Bushes
	KPK7	- 10 Tonne
		165mm Length Ø25.3/31.8mm

BISON REF	OE REF	DESCRIPTION / APPLICATION
 DFKP0010	KPKW009	KING PIN KIT - WHEEL SET
	KPK9	<b>70 80 90</b>
		<b>CONSTRUCTOR, FREIGHTER</b>
		<b>ROADTRAIN</b>
		215mm Length Ø38/48mm

BISON REF	OE REF	DESCRIPTION / APPLICATION
Sorry Picture Is not available	DFKP0006	KPKW029
		KPKW028
		<b>45</b> - 10 Tonne
		With New Roller Bearing Type Bushes
		165mm Length Ø25.3/31.8mm

BISON REF	OE REF	DESCRIPTION / APPLICATION
 DFKP0002	0118086	KING PIN KIT - WHEEL SET
		<b>MB200</b>
		<b>F2100 2105 2200 2205 2300 2305 3300</b>
		270mm Length Ø31.5mm/50mm

BISON REF	OE REF	DESCRIPTION / APPLICATION
 DFKP0007	KPKW027	KING PIN KIT - WHEEL SET
	KPKW27	<b>45 50 60</b> - 10 Tonne
	KPK27	(8 Wheel Stud)
	HKP27	171mm Length Ø32/40mm

BISON REF	OE REF	DESCRIPTION / APPLICATION
 DFKP0001	0681621	KING PIN KIT - WHEEL SET
	0680374	<b>MB200 MB230 SB/R2300 3000</b>
		<b>F1600 2300 2305 2800 2805 3300</b>
		<b>F3305 F3600</b>
		270mm Length Ø31.5/50mm





BISON REF	OE REF	DESCRIPTION / APPLICATION
 DFKP0011	0683469	KING PIN KIT - WHEEL SET
		<b>LF45</b> - 7.5 Tonne
		171mm Length Ø32/40mm

BISON REF	OE REF	DESCRIPTION / APPLICATION
 DFKP0003	KPKW008	KING PIN KIT - WHEEL SET
	HKP1378	<b>45</b> - Up To 1996 7.5 Tonne
	KPK8	(6 Stud Wheel)
		*Without Top Cap
		165mm Length Ø25.3/3.8mm

BISON REF	OE REF	DESCRIPTION / APPLICATION

BISON REF	OE REF	DESCRIPTION / APPLICATION
 DFKP0004	KPKW030	KING PIN KIT - WHEEL SET
	KPKW025	<b>45</b> - Up To 1996 7.5 Tonne
	KPK30	(6 Stud Wheel)
	KPK25	*With Top Cap
		165mm Length Ø25.3/3.8mm

BISON REF	OE REF	DESCRIPTION / APPLICATION

BISON REF	APPLICATION	OE Ref	DIMENSIONS	BISON REF	APPLICATION	OE Ref	DIMENSIONS
<b>FUELCAP02</b> 	75 - 85 - 95	1699734 2534687	Ø80mm Metal Locking Bayonet				
<b>FUELCAP04</b> 	75 - 85 - 95	0288491 0288639	Ø80mm Metal Non Locking Bayonet				
<b>FUELCAP01</b> 	75 - 85 - 95	1699734 2534687	Ø80mm Plastic Locking Bayonet				
<b>FUELCAP03</b> 	75 - 85 - 95	0288491 0288639	Ø80mm Plastic Non Locking Bayonet				

BISON REF	OE REF	DESCRIPTION / APPLICATION
 <b>DFAB0016</b>	1265209	CLUTCH MASTER CYLINDER
		<b>75CF 85CF</b>
		<b>75 85 95</b>

BISON REF	OE REF	DESCRIPTION / APPLICATION
 <b>DFAB0014</b>	628275	CLUTCH SERVO
	625111	<b>85</b>
	626580	
	626784	

 <b>DFAB0017</b>	0094660	CLUTCH MASTER CYLINDER
	0223443	<b>75CF 85CF</b>
	0894880	<b>75 85 95</b>

 <b>DFAB0009</b>	9700514230	CLUTCH SERVO
	9700514070	
		Ø100mm x 85mm Stroke x 6000 Force

 <b>DFAB0018</b>	1291190	CLUTCH MASTER CYLINDER
		<b>75CF 85CF</b>
		<b>95</b>
		<b>95XF XF95</b>

 <b>DFAB0008</b>	0659807	CLUTCH SERVO
	9700511140	
	9700511147	
	0501202572	
	0501204975	Ø75mm, x 67mm Stroke x 4000 Force

 <b>DFAB0019</b>	1339412	CLUTCH MASTER CYLINDER
		<b>CF65</b>
		<b>75 85 95</b>
		<b>85CF</b>

 <b>DFAB0001</b>	1379776	SOLENOID VALVE
	1457276	<b>65CF 75CF 85CF</b>
		<b>CF65 CF75 CF85</b>
		<b>95XF</b>

 <b>DFAB0020</b>	1330770	CLUTCH SERVO
	1346864	<b>75</b>
	1443530	

 <b>DFAB0002</b>	1286867	SOLENOID VALVE
	1303948	<b>65CF</b>
	1379772	<b>75CF 85CF</b>
	1457275	<b>95XF</b>

 <b>DFAB0021</b>	1242618	CLUTCH SERVO
	1443520	<b>75CF 85CF</b>
	1443521	<b>95XF</b>

 <b>DFAB0003</b>	1353582	FOOT BRAKE VALVE
	1209116	<b>65 75 85 95</b>
	1337184	<b>CF65 CF75 CF85</b>
	1136045	<b>XF95</b>





	BISON REF	OE REF	DESCRIPTION / APPLICATION
	DFAB0022	0759050	LEVELLING VALVE
		1341990	<b>75CF 85CF</b>
		1445900	<b>95XF</b>
		1600469	<b>CF75 CF85</b>
		1604351	

	BISON REF	OE REF	DESCRIPTION / APPLICATION
	DFAB0004	1518085	DIRECTIONAL CONTROL VALVE
		4630370010	

	BISON REF	OE REF	DESCRIPTION / APPLICATION
	DFAB0023	1504925	LEVELLING VALVE
			<b>VARIOUS</b>

	BISON REF	OE REF	DESCRIPTION / APPLICATION
	DFAB0005	0642909	3/2 DIRECTIONAL CONTROL VALVE
		4630220200	

	BISON REF	OE REF	DESCRIPTION / APPLICATION
	DFAB0015	0084266	LOAD SENSING VALVE
		1302096	(VOSS CONNECTIONS)
		1518126	<b>85</b>
		1518969	
		4757110680	

	BISON REF	OE REF	DESCRIPTION / APPLICATION
	DFAB0006	1505078	3/2 WAY VALVE
		4630132100	

	BISON REF	OE REF	DESCRIPTION / APPLICATION
	DFAB0012	4757111260	LOAD SENSING VALVE
		4757110680	*AIR SUSPENSION
		4757110687	CONTROL PRESSURE 0.5 TO 5.9 BAR
		4757111267	VOSS FITTING

	BISON REF	OE REF	DESCRIPTION / APPLICATION
	DFAB0007	1518078	3/2 WAY VALVE
		0501207522	
		4630131140	

	BISON REF	OE REF	DESCRIPTION / APPLICATION
	DFAB0013	4757120000	LOAD SENSING VALVE
		4757120007	*MECHANICAL

	BISON REF	OE REF	DESCRIPTION / APPLICATION
	DFAB0010	9730093000	TRAILER CONTROL VALVE
		9730093007	

	BISON REF	OE REF	DESCRIPTION / APPLICATION
	DFAB0011	9730112050	RELAY VALVE
		9730112000	*OVERLOAD PROTECTION
		9730112057	M22 x M16 x 1.5 VOSS C/W SILENCER

	BISON REF	OE REF	DESCRIPTION / APPLICATION



BISON REF	OE REF	DESCRIPTION / APPLICATION
	<b>DFM0001</b>	REAR AXLE SPRAY SUPPRESSION TRUCK FLAPS
		<b>CF65 CF75 CF85 XF95 95XF XF105</b>
		TOP WIDTH - 620mm - BOTTOM WIDTH 690mm
		FULL LENGH - 1000mm BOTTOM OUT- CROPED HEIGHT - 400mm

BISON REF	OE REF	DESCRIPTION / APPLICATION
	<b>DFM0007</b>	AMPB334 HAND BRAKE CABLE - LH
		<b>45</b>
		(LONG)

	<b>DFM0002</b>	1681575	AIR DRYER FILTER
			<b>CF65 CF75 CF85</b>
			<b>XF95 95XF XF105</b>

	<b>DFM0008</b>	0620646	WHEEL STUD FRONT
		0620647	<b>CF65 CF85</b>
		1309191	<b>XF105</b>
			L85mm

	<b>DFM0003</b>	0295024	THERMOSTAT
		0750562	<b>75 85 95</b>
		1293885	<b>95XF</b>
			*75 DEGREES

	<b>DFM0009</b>	0890763	WHEEL STUD FRONT
		1309190	<b>65CF</b>
		1356736	
			L94mm

	<b>DFM0004</b>		THERMOSTAT
			<b>75 85 95</b>
			<b>95XF</b>
			*80 DEGREES

	<b>DFM0010</b>	0620648	WHEEL STUD REAR
		0620649	<b>75CF 85CF</b>
		1308038	<b>CF65 CF75 CF85</b>
		1373007	<b>XF95 95XF XF105</b>
		L100mm	

	<b>DFM0005</b>	1204236	INTERCOOLER HOSE
			<b>75 85 95</b>
			<b>95XF</b>
			ID 100mm x OD 110mm x L125mm

	<b>DFM0011</b>	0652575	WHEEL NUT
		1356737	<b>75CF 85CF</b>
			<b>CF65 CF75 CF85</b>
			<b>XF95 95XF XF105</b>

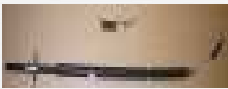
	<b>DFM0006</b>	AMPB333	HAND BRAKE CABLE - RH
			<b>45</b>
			(SHORT)

	<b>DFM0012</b>	1300662	RELAY VALVE, SPLITTER
		1374724	<b>CF75 CF85</b>
			<b>XF95</b>

	BISON REF	OE REF	DESCRIPTION / APPLICATION
	<b>DAF016</b>	1620627	HEADLIGH T W/O LEVELING - RH
		1641755	<b>LF CF XF</b>
		1699306	
		1699319	
		1641747	

	BISON REF	OE REF	DESCRIPTION / APPLICATION
	<b>DAF023</b>		SPOT & FOG LAMP - RH *BLUE
			<b>LF CF XF</b>

	BISON REF	OE REF	DESCRIPTION / APPLICATION
	<b>DAF017</b>	1620626	HEADLIGH T W/O LEVELING - LH
		1699305	<b>LF CF XF</b>
		1641754	
		1699318	
		1641746	

	BISON REF	OE REF	DESCRIPTION / APPLICATION
	<b>DAF022</b>		SPOT & FOG LAMP - LH *BLUE
			<b>LF CF XF</b>

	BISON REF	OE REF	DESCRIPTION / APPLICATION
	<b>DAF018</b>	1699303	HEADLIGH T WITH LEVELING - RH
		1621895	<b>LF CF XF</b>
		1621897	
		1624719	

	BISON REF	OE REF	DESCRIPTION / APPLICATION
	<b>DAF025</b>	1449529	SPOT & FOG LAMP BRACKET - RH
			<b>LF CF XF</b>

	BISON REF	OE REF	DESCRIPTION / APPLICATION
	<b>DAF019</b>	1699302	HEADLIGH T WITH LEVELING - LH
		1641756	<b>LF CF XF</b>
		1699302	
		1743688	

	BISON REF	OE REF	DESCRIPTION / APPLICATION
	<b>DAF026</b>	1449528	SPOT & FOG LAMP BRACKET - LH
			<b>LF CF XF</b>

	BISON REF	OE REF	DESCRIPTION / APPLICATION
	<b>DAF021</b>	1328861	SPOT & FOG LAMP - RH *CLEAR
			<b>LF CF XF</b>

	BISON REF	OE REF	DESCRIPTION / APPLICATION
	<b>DAF105</b>	1725270	SPOT & FOG LAMP - RH
			<b>LF CF XF</b>

	BISON REF	OE REF	DESCRIPTION / APPLICATION
	<b>DAF020</b>	1328860	SPOT & FOG LAMP - LH CLEAR
			<b>LF CF XF</b>

	BISON REF	OE REF	DESCRIPTION / APPLICATION
	<b>DAF104</b>	1725271	SPOT & FOG LAMP - RH
			<b>LF CF XF</b>

	BISON REF	OE REF	DESCRIPTION / APPLICATION
	<b>DAF124</b>	1293371	HEADLIGH T - RH <b>65 75 85</b>
	<b>DAF126</b>	1318145	REPLACEMENT GLASS - RH

	BISON REF	OE REF	DESCRIPTION / APPLICATION
	<b>DAF088</b>	1293364	HEADLIGH T - LH <b>XF95 1st Series</b>

	<b>DAF123</b>	1293370	HEADLIGH T - LH <b>65 75 85</b>
	<b>DAF125</b>	1318143	REPLACEMENT GLASS - LH



	<b>DAF116</b>		HEADLIGH T - RH <b>95</b>
	<b>DAF118</b>		REPLACEMENT GLASS - RH



	<b>DAF115</b>		HEADLIGH T - LH <b>95</b>
	<b>DAF117</b>		REPLACEMENT GLASS - LH



	<b>DAF131</b>		INDICATOR RH & LH <b>95 95XF 1st Series</b>

	<b>DAF087</b>	1293365	HEADLIGH T - RH <b>XF95 1st Series</b>



BISON REF	OE REF	DESCRIPTION / APPLICATION
	<b>0867500</b>	COMPLETE REAR LAMP ASSEMBLY – RH
		*WITH REG LAMP
		<b>VARIOUS</b>
		*CABLE ENTRY: UNDERSIDE DIRECT
		510 X 125

BISON REF	OE REF	DESCRIPTION / APPLICATION
	<b>1357075</b>	COMPLETE REAR LAMP ASSEMBLY – LH
	<b>1625985</b>	*WITH REG LAMP 460 X 125
		<b>75CF 85CF CF75 CF85</b>
		<b>LF45 LF55 XF95 XF105</b>
		*CABLE ENTRY: SINGLE 6 PIN SIDE ENTRY SOCKET

	<b>0867499</b>	COMPLETE REAR LAMP ASSEMBLY – LH
		<b>VARIOUS</b>
		*CABLE ENTRY: UNDERSIDE DIRECT
		510 X 125

	<b>067569</b>	REAR LIGHT LENS RH & LH
		<b>VARIOUS</b>
		340 X 140

	<b>1304788</b>	COMPLETE REAR LAMP ASSEMBLY – RH
		<b>65CF 75CF 85CF 95XF</b>
		<b>65 75 85 95</b>
		*CABLE ENTRY: SINGLE 6 PIN SOCKET CENTRE
		460 X 125

	<b>0698603</b>	REAR LIGHT LENS RH & LH
		<b>VARIOUS</b>
		412 X 132

	<b>1304789</b>	COMPLETE REAR LAMP ASSEMBLY – LH
		<b>65CF 75CF 85CF 95XF</b>
		<b>65 75 85 95</b>
		*CABLE ENTRY: SINGLE 6 PIN SOCKET CENTRE
		460 X 125

	<b>DAF063</b>	COMPLETE REAR LAMP ASSEMBLY - RH
		*WITHOUT REG LAMP
		<b>LF45 LF55</b>
		350 x 130

	<b>1272653</b>	REAR LENS
		<b>75CF 85CF CF75 CF85</b>
		<b>LF45 LF55 XF95 XF105</b>
		460 X 125

	<b>DAF062</b>	COMPLETE REAR LAMP ASSEMBLY – LH
		*WITH REG LAMP
		<b>LF45 LF55</b>
		350 x 130

	<b>1357076</b>	COMPLETE REAR LAMP ASSEMBLY – RH
	<b>1625986</b>	*WITH REG LAMP 460 X 125
		<b>75CF 85CF CF75 CF85</b>
		<b>LF45 LF55 XF95 XF105</b>
		*CABLE ENTRY: SINGLE 6 PIN SIDE ENTRY SOCKET

	<b>DAF064</b>	<b>1451482</b>	REPLACEMENT LENS RH & LH
			<b>LF45 LF55</b>
			350 x 130



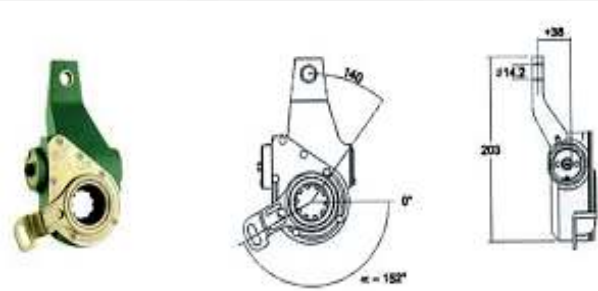

To Fit:  
**DAF Truck and Bus**  
 Replaces Haldex:  
**72524**  
 Replaces OEM:  
**0159557**  
 Spline Type:  
**10 SAE 1-1/2" - 10c**  
 Control Arm:  
**Type 4**  
 Supplied with:  
 \*

DAF2015      0159557, 72524, 72108

**55, 75, 85, 95 -**  
**LH AXLE POSITION 1**

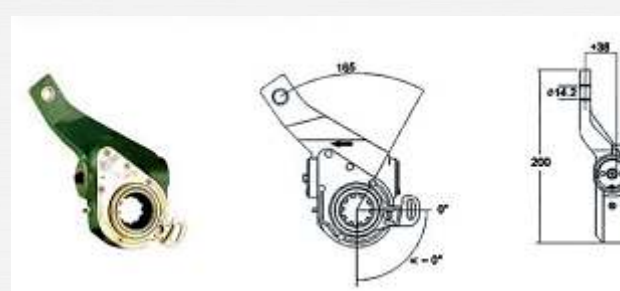

To Fit:  
**DAF Truck**  
 Replaces Haldex:  
**72542**  
 Replaces OEM:  
**0159561**  
 Spline Type:  
**10 SAE 1-1/2" - 10c**  
 Control Arm:  
**Type 1**  
 Supplied with:  
 \*

DAF2105      0159561, 72542, 72310

**75, 85, 95 -**  
**RH AXLE POSITION 2**

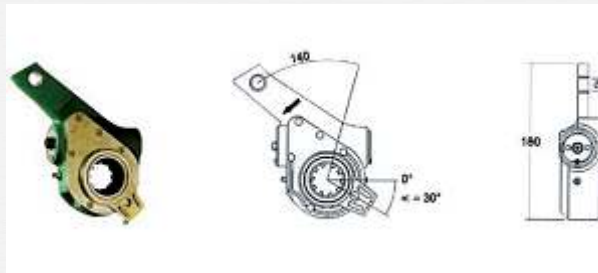

To Fit:  
**DAF Truck and Bus**  
 Replaces Haldex:  
**70871**  
 Replaces OEM:  
 \*  
 Spline Type:  
**10 SAE 1-1/2" - 10c**  
 Control Arm:  
**Type 5**  
 Supplied with:  
**Peg Bolt**

DAF2010      0159556, 72523, 72107

**55, 75, 85, 95 -**  
**RH AXLE POSITION 1**

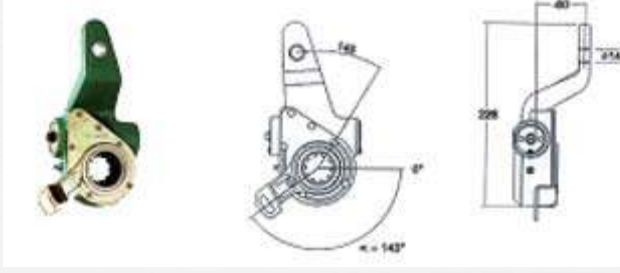

To Fit:  
**DAF Truck**  
 Replaces Haldex:  
**72887**  
 Replaces OEM:  
**1263486**  
 Spline Type:  
**10 SAE 1-1/2" - 10c**  
 Control Arm:  
**Type 4**  
 Supplied with:  
 \*

DAF3425      1282111, 79024

**75, 85 -**  
**LH AXLE POSITION 3**

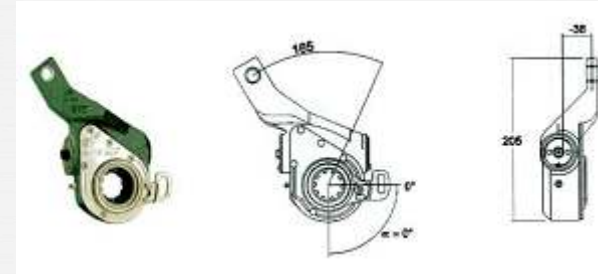

To Fit:  
**DAF Truck**  
 Replaces Haldex:  
**72543**  
 Replaces OEM:  
**0159562**  
 Spline Type:  
**10 SAE 1-1/2" - 10c**  
 Control Arm:  
**Type 1**  
 Supplied with:  
 \*

DAF2035      0159562, 72543, 72311

**75, 85, 95 -**  
**LH AXLE POSITION 2**

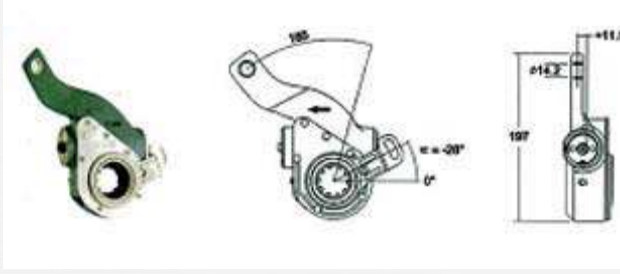

To Fit:  
**DAF Truck**  
 Replaces Haldex:  
**79024**  
 Replaces OEM:  
**1282111**  
 Spline Type:  
**10 SAE 1-1/2" - 10c**  
 Control Arm:  
**Type 4**  
 Supplied with:  
 \*

DAF3430      1282112, 79025

**75, 85 -**  
**RH AXLE POSITION 3**

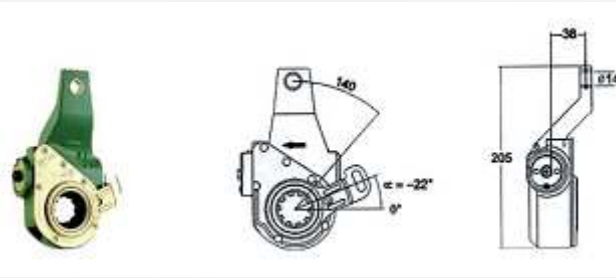

To Fit:  
**DAF Truck and Bus**  
 Replaces Haldex:  
**72525**  
 Replaces OEM:  
**0159558**  
 Spline Type:  
**10 SAE 1-1/2" - 10c**  
 Control Arm:  
**Type 4**  
 Supplied with:  
 .

DAF2115                      0159558, 72525, 72109                      **75, 85 -**  
 LH AXLE POSITION 2

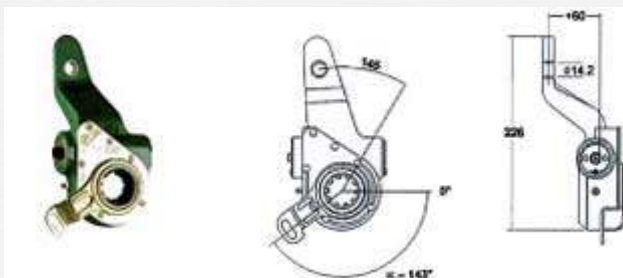

To Fit:  
**DAF Truck**  
 Replaces Haldex:  
**72886**  
 Replaces OEM:  
**1263485**  
 Spline Type:  
**10 SAE 1-1/2" - 10c**  
 Control Arm:  
**Type 4**  
 Supplied with:  
 .

DAF2725                      1263485, 72886                      **75, 85 -**  
 RH AXLE POSITION 3

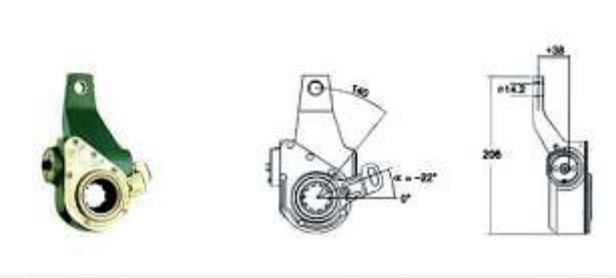

To Fit:  
**DAF Truck and Bus**  
 Replaces Haldex:  
**72526**  
 Replaces OEM:  
**0159559**  
 Spline Type:  
**10 SAE 1-1/2" - 10c**  
 Control Arm:  
**Type 4**  
 Supplied with:  
 .

DAF2125                      0159559, 72526, 72110                      **75, 85 -**  
 RH AXLE POSITION 2

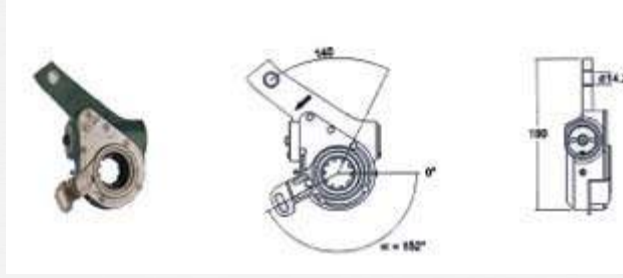

To Fit:  
**DAF Bus**  
 Replaces Haldex:  
**72535**  
 Replaces OEM:  
**0159565**  
 Spline Type:  
**10 SAE 1-1/2" - 10c**  
 Control Arm:  
**Type 4**  
 Supplied with:  
 .

DAF2515                      72535                      **75 - RH & LH AXLE POSITION 3**

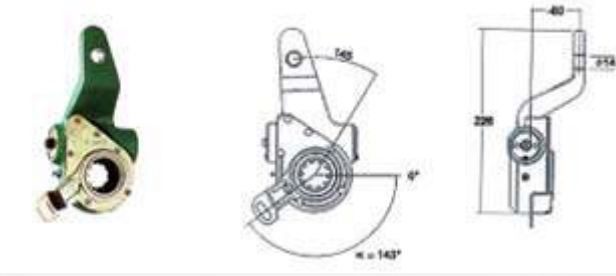

To Fit:  
**DAF Truck**  
 Replaces Haldex:  
**72887**  
 Replaces OEM:  
**1263486**  
 Spline Type:  
**10 SAE 1-1/2" - 10c**  
 Control Arm:  
**Type 4**  
 Supplied with:  
 .

DAF2730                      1263486, 72887                      **75, 85 -**  
 LH AXLE POSITION 3

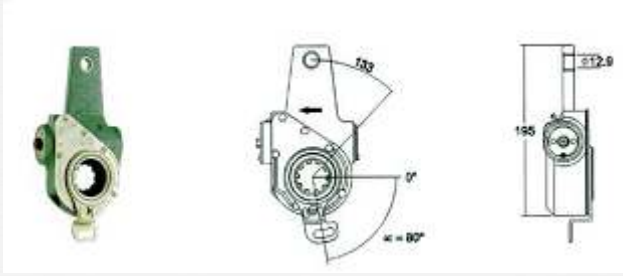

To Fit:  
**Leyland Truck**  
 Replaces Haldex:  
**72406**  
 Replaces OEM:  
**ACU8347**  
 Spline Type:  
**10 SAE 1-1/2" - 10c**  
 Control Arm:  
**Type 1**  
 Supplied with:  
 .

DAF2180                      ACU8347, 72406                      **80 - LH & RH AXLE POSITION 2**

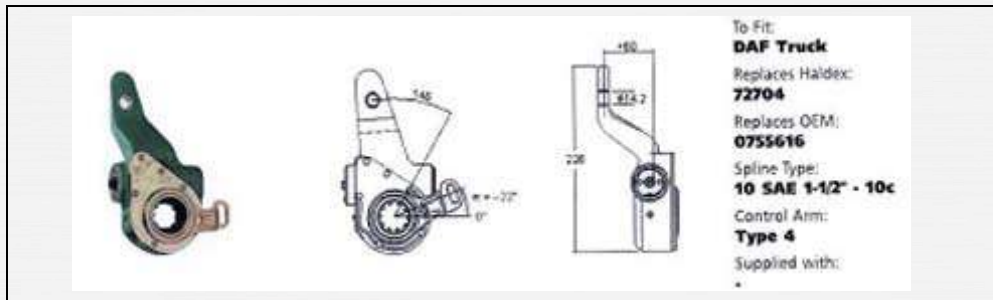

To Fit:  
**DAF Truck**  
 Replaces Haldex:  
**72704**  
 Replaces OEM:  
**0755616**  
 Spline Type:  
**10 SAE 1-1/2" - 10c**  
 Control Arm:  
**Type 4**  
 Supplied with:

DAF3700                      0755616, 72704                      **85, 95 -**  
 LH AXLE POSITION 4

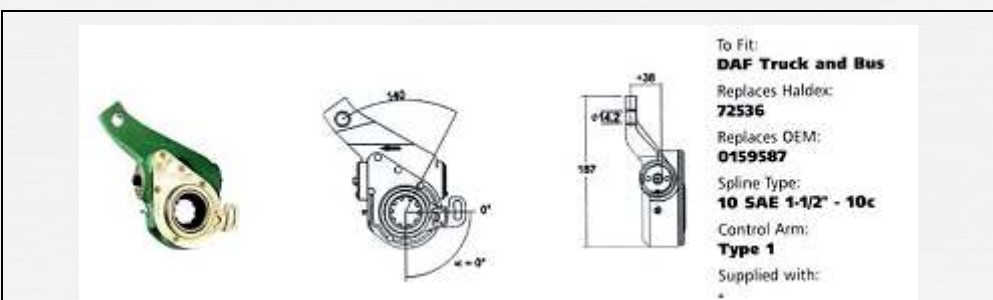

To Fit:  
**DAF Truck and Bus**  
 Replaces Haldex:  
**72536**  
 Replaces OEM:  
**0159587**  
 Spline Type:  
**10 SAE 1-1/2" - 10c**  
 Control Arm:  
**Type 1**  
 Supplied with:

DAF2110                      0159587, 72536, 72223,                      **55, 95 -**  
 LH AXLE POSITION 2

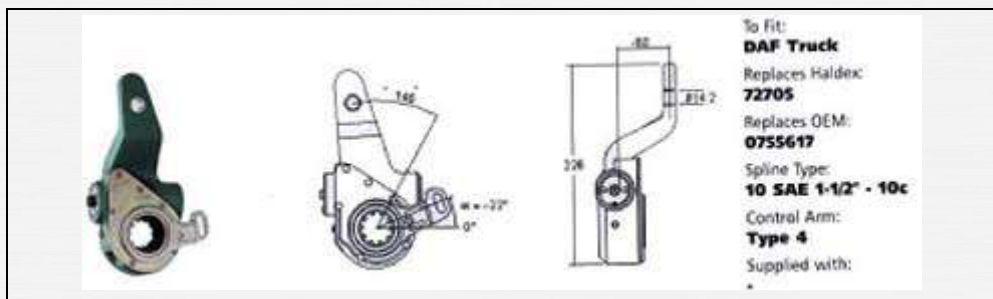

To Fit:  
**DAF Truck**  
 Replaces Haldex:  
**72705**  
 Replaces OEM:  
**0755617**  
 Spline Type:  
**10 SAE 1-1/2" - 10c**  
 Control Arm:  
**Type 4**  
 Supplied with:

DAF3705                      0755617, 72705                      **85, 95 -**  
 RH AXLE POSITION 4

Sorry Picture Is not available

DAF2120                      0159588, 72537, 72224                      **55, 95 -**  
 LH AXLE POSITION 2

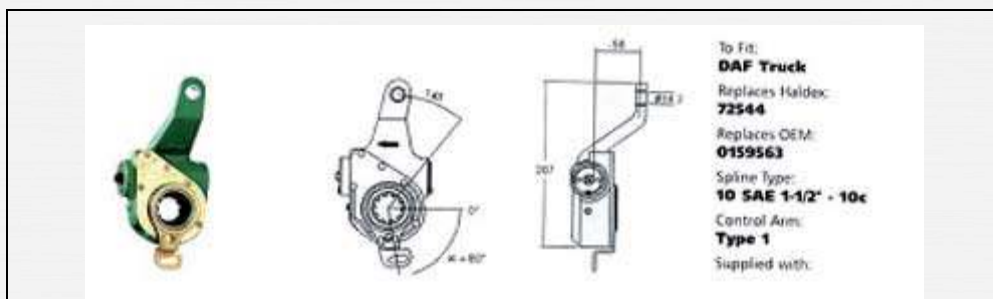

To Fit:  
**DAF Truck**  
 Replaces Haldex:  
**72544**  
 Replaces OEM:  
**0159563**  
 Spline Type:  
**10 SAE 1-1/2" - 10c**  
 Control Arm:  
**Type 1**  
 Supplied with:

DAF3655                      0159563, 72544, 72312                      **95 -** LH AXLE POSITION 2 & 3

Sorry Picture Is not available

DAF4175                      72695                      **65 -**  
 LH AXLE POSITION 1 & 2



Sorry Picture Is not available

DAF4180

72696

**65 -**  
LH AXLE POSITION 1 & 2

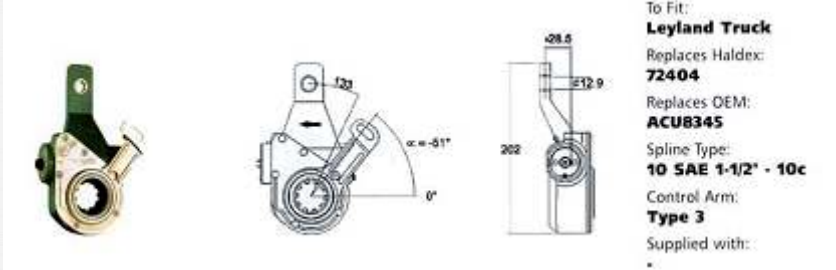

DAF2190

ACU8345, 72404

**80 -**  
LH AXLE POSITION 1

Sorry Picture Is not available

DAF2185

ACU8344, 72403

**80 -**  
RH AXLE POSITION 1



Sorry Picture Is not available

DAF2020

0159589, 72538, 12302

**85, 95 -**  
LH AXLE POSITION 2

Sorry Picture Is not available

DAF2025

0159590, 72536, 72301

**85, 95 -**  
RH AXLE POSITION 2

Company Address:

Bison Parts

C/O Fleet Services

Sheffield

S9 5EU

TEL: 07792813409

EMAIL: [sales@bisonparts.co.uk](mailto:sales@bisonparts.co.uk)

WWW: [www.bisonparts.co.uk](http://www.bisonparts.co.uk)

