

Belcom

PR04815-1

Digital Video SDV, HDTV, DTV

“The
Future is
HDTV”

The digital revolution has created a demand for the fidelity that HDTV brings to radio and television broadcasters.

HDTV requires the highest technology advances in cable engineering. This is brought to you with Belcom's range of HD coaxial cables.



Event
Audio & Broadcast Cables

plasa
member

CEDIA
CUSTOM
ELECTRONIC
DESIGN &
INSTALLATION
ASSOCIATION

Member

T: 01279 871150 | F: 01279 871129 | www.belcom.co.uk

HD Serial Digital Video Cable 75 Ω LSZH FireFighter

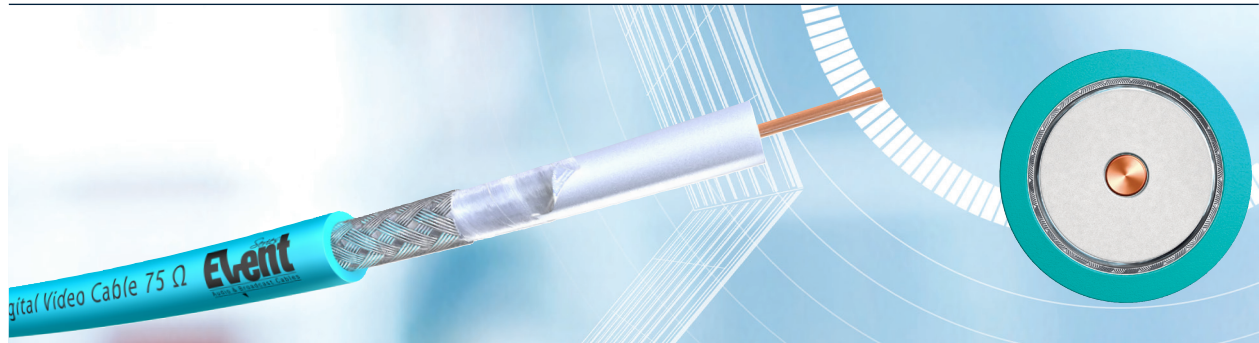

Description

EventSeries HD Series 75 Ohm digital coaxial, small and light suitable for serial digital & analogue video signal transmission.

- Public buildings, schools, government & marine.
- Low Loss & Extremely Low Loss Versions

Technical Description

Conductor	bare copper wire
Formation	Bare copper conductor with Foam Dielectric and shield
Screen Type	Type 1° - Aluminium/polyester/Aluminium screen + Tinned copper wire braid Type 2° - Tinned copper wire braid + Tinned copper wire braid (Dual braid)
Outer Jacket	LSZH FireFighter® IEC 60332-1
Colours	see specification table

Specification

Part Number	Colour	Construction	Screen Type	Attenuation 100MHz/100m	Overall Diameter (mm)
HD300	■	1 x 0,30 mm	Type 1°	22 dB	2,54
HD600	■ ■ ■ ■	1 x 0,65 mm	Type 1°	10 dB	4,50
HD720	■	1 x 0,80 mm	Type 1°	7,5 dB	5,90
HD850-01	■	7 x 0,29 mm	Type 2°	9,8 dB	6,00
HD1000	■	1 x 1,00 mm	Type 1°	6,4 dB	6,80
HD1300	■	1 x 1,30 mm	Type 1°	4,7 dB	9,00
HD1630	■	1 x 1,63 mm	Type 1°	4,2 dB	10,20

Maximum Transmission Length for HD Serial Digital Video Cable

Data Rate	143 Mb/s	177 Mb/s	270 MB/s	1.5 Gb/s	3 Gb/s
Spec	SMPTE 259M	ITU-R BT601	SMPTE 259M	SMPTE 292M (SMPTE 372M)	SMPTE 424M
Application	Composite NTSC	Composite PAL	Composite SDI	720p -1080i (Dual Link 1080p)	1080p
Part No.	Calculated Transmission Length (m)	Calculated Transmission Length (m)	Calculated Transmission Length (m)	Calculated Transmission Length (m)	Calculated Transmission Length (m)
HD300	152	137	116	34	24
HD600	320	311	261	87	52
HD720	436	326	338	94	67
HD850	366	415	253	66	44
HD1000	573	521	436	122	82
HD1300	740	665	537	146	100
HD1630	838	756	622	168	110

Application		Composite Video FBAS	S-Video S-VHS,Y/C	Component Video RGB , YUV
Part No.	Attenuation 100MHz/100m	Calculated Transmission Length (m)	Calculated Transmission Length (m)	Calculated Transmission Length (m)
HD300	22dB	50	50	50
HD600	10dB	121	121	121
HD720	7.5dB	149	149	149
HD850	9.8dB	105	105	105
HD1000	6.4dB	208	208	208
HD1300	4.7dB	320	320	320
HD1630	4.2dB	329	329	329

The calculated transmission distances are based on a formula in the SMPTE standards , in many cases tested distances are greater. Please use calculated distances prior to testing and allow sufficient headroom.

BNC HD Crimp plug to suit HD Series coaxial Cables

High performance true 75Ω BNC has been developed specifically for HD BNC applications and has return loss aimed for the outside broadcast environment.

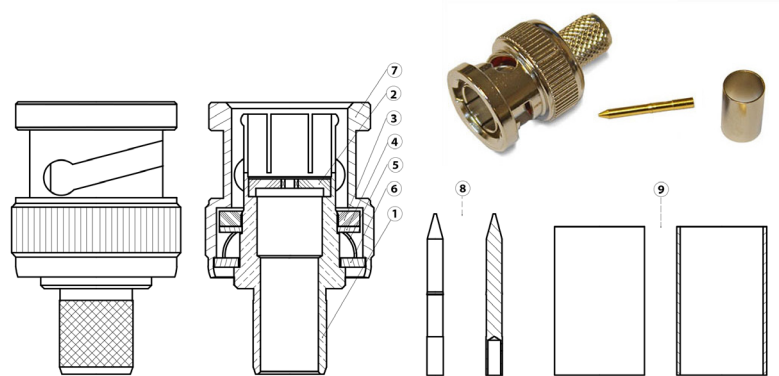

1 - Body 2 - Insulator 3 - Gasket 4 - Spring 5 - C Ring 6 - Washer 7 - Shell 8 - Contact Pin 9 - Ferrule

HD Crimp Tool Kit [TL9565](#)

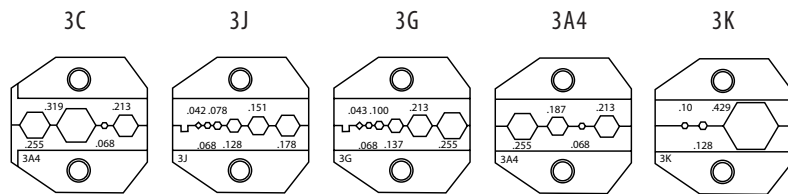
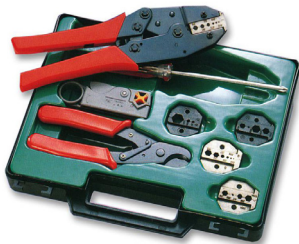

Die Sets

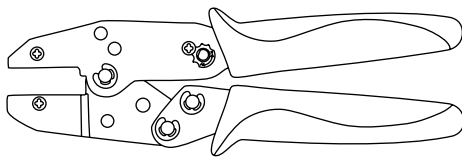

Crimp Tool Frame

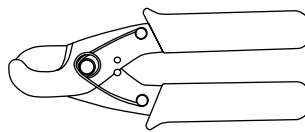

Cutter Tool

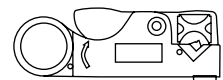

Stripper Tool

Connector Part #	To suit cable type	Tool Kit Part #	Ferrule Die Set	Contact Die Set
BNC1CHD300	HD300	TL-9565	3J	3J or 3G
BNC1CHD600	HD600	TL-9565	3A4	3J or 3G
BNC1CHD720	HD720	TL-9565	3C	3J or 3G
BNC1CHD850	HD850	TL-9565	3C	3J or 3G
BNC1CHD1000	HD1000	TL-9565	3C	3J or 3G