

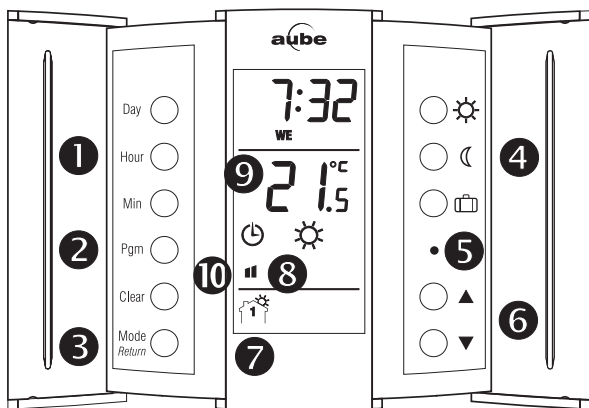

Control Module TH132 A/F/AF Owner's Guide

Thank you for choosing the Aube TH132, a programmable thermostat that provides both energy savings and total comfort.



TH132 Description

- 1 DAY/HOUR/MIN—Set the day and clock settings.
- 2 PGM—Program the schedule (programs).
- 3 MODE—Select the operating mode.
RETURN—To exit a function.
- 4 To configure temperature setpoints:
☀ Comfort, ☾ Economy and 🗑 Vacation.
- 5 Adjust the floor temperature limit (AF only).
- 6 ▲▼—Increase and decrease temperature.
- 7 🌡️ 🌡️* 🌡️** 🌡️***—Indicates the number of the current program when Automatic mode is enabled.
- 8 Current operating mode (auto ☺ / manual 🌡️). In Auto mode, the program's associated setpoint icon is also displayed (☀ ☾).
- 9 Indicates the room OR floor temperature.
- 10 Heating indicators (see "Temperature Control" below).

Models Overview

TH132-A

This model has been designed to control a room's ambient temperature.
The TH132-A has one temperature sensor located in the control module.

TH132-AF

This model is designed to use a floor sensor to control the room temperature.

The TH132-AF has two temperature sensors:

- The first one, installed in the control module, controls the ambient temperature.
- The second one, installed in the floor (and connected to the power base), limits the temperature of the floor (the default setting of this limit is 82°F).

TH132-F

This model is designed to control floor heating systems.
The TH132-F has one temperature sensor installed in the floor (sensor is connected to the power base).

1 Configure the Switches

The TH132 has two switches, located on the upper-left part on the rear of the control module, which are used to set the following options:

Early Start

When the Early Start function is enabled (disabled by default), the TH132 calculates the optimum system start time to obtain the desired temperature by the set time. To enable this function:

- ▶ Position switch #1 down.

Note: When this function is enabled, the system can be activated before the program's start time.

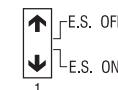

Temperature Display

By default, the TH132 displays the temperature in °C. If you wish to change to °F:

- ▶ Position switch #2 up.

Note: When you switch from °C to °F or vice versa, the ☀, ☾ and 🗑 setpoints must be redefined.



2 Install the Control Module

Align the bracket tabs on the control module with the holes located on top of the power base.

This control module must be installed on a PB130 series power base.

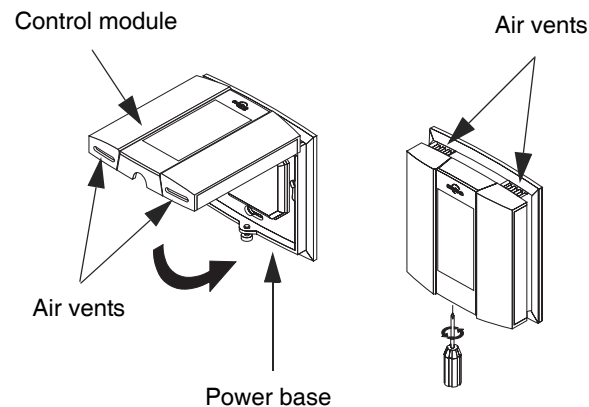

Note: Keep the thermostat's air vents clean and free from obstructions.

Note: The screw cannot be removed completely.

First Power ON

On the first installation, the screen displays: 0:00, MO, 🌡️ and temperature (room/floor).

For Floor Heating Installations:

One of the two following messages may be displayed when a problem occurs:

LO: The floor temperature is below 32°F (0°C), or the temperature sensor is defective, or not connected.

The heating indicator 🌡️🌡️🌡️ is displayed and the relay is closed (energized).

HI: The floor temperature is above 140°F (60°C), or the temperature sensor is defective.

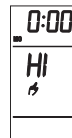
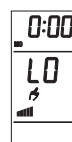

3 Set the Time and Day

- 1 Set the time (HOUR - MIN).
- 2 Set the day (DAY).

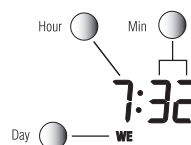

If you remove the module from its base for more than 2 hours, the time and day will have to be reprogrammed.

4 Adjust the Temperature Setpoints

Comfort ☀ and Economy ☾ Setpoints

These setpoints are associated with the schedule's programs (prog. 1 & 3 = Comfort, prog. 2 & 4 = Economy) and are preprogrammed as follows:

- ▶ A & AF models—☀ 68°F, ☾ 64°F
- ▶ F model—☀ 82°F, ☾ 68°F

To modify a setpoint:

- 1 Set the temperature using ▲▼ and press and hold the ☀ or ☾ button until it is displayed on the screen.
- 2 Press MODE/RETURN to exit.

Vacation 🗑 Setpoint

The vacation setpoint is associated to the Vacation operating mode and is preprogrammed to 50°F. To modify this setpoint, repeat above steps.

Floor Temperature Setpoint (AF model only)

The floor temperature limit is preprogrammed to 82°F to avoid damage to your floor.
To modify, press the adjustment button (below 🗑) using a pointed object, set the desired temperature using ▲▼ and press MODE/RETURN to exit.

5 Select the Operating Mode

The TH132 offers three operating modes:

Automatic ☺—Executes the schedule.

- 1 Press MODE to select ☺. The current program number is displayed.

You can temporarily bypass the current program by setting a specific temperature setpoint ▲▼ or by selecting one of the pre-defined setpoint buttons (☀ ☾). The new setpoint will be maintained until the beginning of the next program.

Manual 🌡️—Maintains a constant temperature.

- 1 Press MODE to select 🌡️.
- 2 Set temperature ▲▼ or select one of the pre-defined setpoint buttons (☀ ☾).

Vacation 🗑—Maintains the Vacation setpoint during a prolonged absence.

- ▶ Press 🗑.

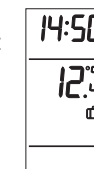
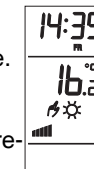

6 Program Your Schedule

The schedule is used with the Automatic mode. The schedule controls the heating system to automatically switch between the Comfort and Economy temperature setpoints at the times you have programmed.

The schedule consists of 4 programs per day defined as follows:

Programs	Setpoint	Time ⁱ
		Wake-up
		Leave home
		Back home
		Night

i. The programs' start time can be different for each day of the week.

To enter the programs' start time

To shorten programming, you simply have to enter the start time for each program.

- Press PGM.
- Press DAY to select the day (hold for 3 seconds to select all days of the week).

Note: It is sometimes faster to program the same schedule for the entire week and then to modify the exception days.

- Press PGM to select the program number (e.g. 1).
- Press HOUR and MIN to set the start time.
- Repeat steps 3 to 4 for remaining programs (e.g. 2, 3 and 4).
- Press MODE/RETURN to exit.

Note: After 60 seconds of inactivity, the thermostat will automatically exit programming mode.

To clear a program time:

When you clear a program time entry, the TH132 will maintain the temperature setpoint of the last executed program until the beginning of the next program.

- Repeat steps 1 to 3 above.
- Press CLEAR to erase the time entry. The time portion of the LCD indicates --:-- when the program is inactive.
- Press MODE/RETURN to exit.

Programming Example

Programs	MO	TU	WE	TH	FR	SA	SU
	6:00	6:00	6:00	6:00	6:00	6:00	6:00
	8:30	8:30	8:30	8:30	8:30	--:--	--:--
	16:00	16:00	16:00	16:00	16:00	--:--	--:--
	23:00	23:00	23:00	23:00	23:00	23:00	23:00

Comfort :

- Monday to Friday, between 6:00 and 8:30 and between 16:00 and 23:00.
- Saturday and Sunday, between 6:00 and 23:00.

Economy :

- Monday to Friday, between 8:30 and 16:00 and between 23:00 and 6:00.
- Saturday and Sunday, between 23:00 and 6:00.

To program this schedule

- Press PGM.
- Press and hold DAY for 3 seconds to select all days of the week.
- Press PGM to select program 1.
Set the time (6:00) using the HOUR and MIN buttons.

- Press PGM to select program 2.
Set the time (8:30) using the HOUR and MIN buttons.
- Repeat step 4 for remaining programs: program 3 (16:00) and program 4 (23:00).
- When all programs are configured, press MODE/RETURN to exit.

To erase programs 2 and 3 for Saturday and Sunday

- Press PGM.
- Press PGM to select program 2.
- Press DAY to select SAaturday (SA).
- Press CLEAR to erase the time (--:--).
- Press DAY to select SUneday (SU).
- Press CLEAR to erase the time (--:--).
- Press PGM to select program 3.
- Repeat steps 3 to 6.
- Press MODE/RETURN to exit.

Temperature Control

The TH132 thermostat works differently than conventional electromechanical thermostats.

It is equipped with a proportional integral adaptive (PIA) controller which determines heating cycles by analyzing the temperature behavior history within the room.

The PIA controller reduces temperature swings providing accurate temperature control while increasing user comfort.

The controller determines the amount of power required by the heating system to maintain the setpoint temperature.

When the heating system is activated, one of the following icons is displayed:

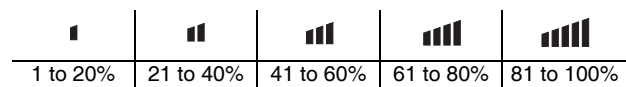

Technical Specifications

Model: TH132 A / AF / F

Display range: 32°F to 140°F (0°C to 60°C)

Setting range (ambient): 40°F to 86°F (5°C to 30°C)

Setting range (floor): 40°F to 104°F (5°C to 40°C)

Pre-programmed temperature setpoints:

- Comfort:** A/AF: 68°F (20°C) and F: 82°F (28°C)
- Economy:** A/AF: 64°F (18°C) and F: 68°F (20°C)
- Vacation:** A/F/AF: 50°F (10°C)
- Floor limit:** AF: 82°F (28°C)

Temperature resolution display scale: 0.1°

Storage: -4°F to 120°F (-20°C to 50°C)

Software: Class A

Controller: Electronic

Temperature control: Proportional integral adaptive, 15-minute heating cycles

Programming protection: Protected memory

Clock protection: 2 hours

Size (H/W/D): 3.3 x 3.1 x 0.5 in (83 x 79 x 13 mm)

Warranty

AUBE TECHNOLOGIES INC. TWO (2) YEAR LIMITED WARRANTY

This product is guaranteed against workmanship defects for a two-year period following the initial date of purchase. During this period, AUBE Technologies Inc. will repair or replace, at our option and without charge, any defective product which has been used under normal conditions.

The warranty does not cover delivery costs and does not apply to products poorly installed or randomly damaged following installation.

This warranty cancels and replaces any other manufacturer's express or implied warranty as well as any other company commitment. AUBE Technologies Inc. cannot be held liable for related or random damages following the installation of this product.

The defective product as well as the purchase invoice must be returned to the place of purchase or mailed, prepaid and insured, to the nearest shipping address.

If you have any questions concerning the programming of the TH132 programmable thermostat, call our technical support team at:



705 Montrichard
Saint-Jean-sur-Richelieu
Quebec, Canada J2X 5K8

10 rue Ampère
95500 Gonesse
France

Tel.: (450) 358-4600
Toll Free: 1-800-831-AUBE

33 (0) 1 34 07 99 00

Fax: (450) 358-4650

33 (0) 1 34 07 99 19

Email: service@aubetech.com advaube@comintes.com

For more information on our products, visit us at:

www.aubetech.com



As an ENERGY STAR® partner, Aube Technologies has determined that this product meets the ENERGY STAR guidelines for energy efficiency.

1 Introduction

The PB130-230 power base is used to power a TH13x Series control module. The resistive load must not exceed 3450 watts (NI) @ 230 VAC (15 A).

2 Installation Guidelines

Turn off power to the heating system at the main power panel to avoid electrical shock. Installation should be carried out by an electrician.

- ▶ All work must conform to the applicable country standards for electrical installations and wiring.
- ▶ This thermostat should be connected on a circuit equipped with a fuse or a circuit breaker. It must be installed on a certified electrical box.
- ▶ For a new installation, choose a location about 1.5 m above the floor.
- ▶ For electric baseboards, convectors and fan-forced heaters, the thermostat must be installed facing the heating system.
- ▶ The thermostat must be installed on an inside wall.
- ▶ Avoid locations where there are air drafts (top of staircase, air outlet), dead air spots (behind a door), direct sunlight or concealed chimneys or stove pipes.

3 Included Parts

- 1 One (1) PB130-230 power base
- 2 One (1) floor sensor (for AF and F control modules only)
- 3 One (1) wall plate (optional, in certain countries)

Technical Specifications

Model: PB130A-230

Supply: 230 VAC, 50 Hz

Load: 15 A maximum (resistive only)

Power: 3450 Watts (NI) @ 230 VAC

Conformity: EN60730-2-9 / EN50081-1 / EN50082-2

Storage: -20°C to 50°C

Protection: Class 2

Protection degree: IP20

Automatic action: Type 1.B

Environment: Normally polluted

Size (H • W • D) : 2.95 x 2.95 x 0.55 in. (75 x 75 x 14 mm)

NOTE: The terminals are designed to handle a cross-section of wire measuring 0.33 to 3.1 mm².

If you have any questions concerning the installation of the PB130-230 power base, contact our technical support team at:



705 Montrichard
Saint-Jean-sur-Richelieu
Quebec, Canada J2X 5K8

Tel.: (450) 358-4600
Toll Free: 1-800-831-AUBE
Fax: (450) 358-4650
Email: service@aubetech.com



10 rue Ampère
95500 Gonesse
France

33 (0) 1 34 07 99 00
33 (0) 1 34 07 99 19
advaube@comintes.com

For more information on our products, visit us at
www.aubetech.com

4 Installation and Wiring

- 1 Remove the screw holding the control module to the power base and lift the lower part upwards. The screw cannot be completely removed.

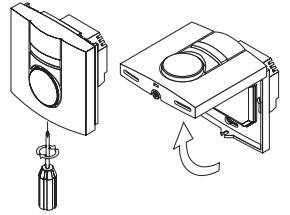

- 2 Before making the connections, make sure that the base covers the electrical box entirely. If not, install a wall plate at the back of the base as shown.

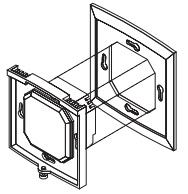

- 3 Connect the wires:

- **Power:**
Terminals 1 & 5
- **Load:**
Terminals 2 & 4
see note 1
- **Pilot Wire:**
Terminal 3
see note 2
- **Floor sensor:**
Terminals 6 & 7
(no polarity)
see note 3

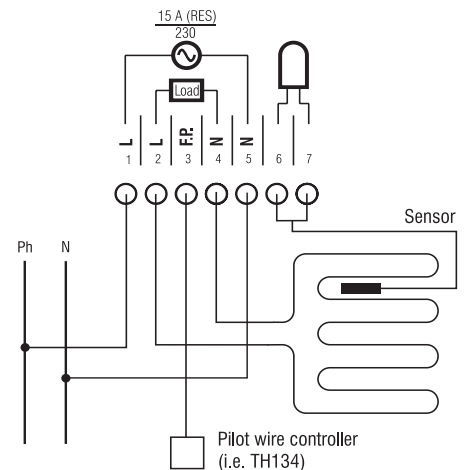

Note 1 If a contactor is used between the thermostat and the load, install a snubber at the contactor's coil terminal to ensure the proper operation of the thermostat.

Note 2 This connection is required on some models only.

Note 3 For the proper operation of the thermostat, the floor sensor must be centered between two heater wires having a maximum temperature of 80°C. The floor sensor wire must not cross any heater wire or be placed close to it.

- 5 Push wires into the electrical box and secure the base to the electrical box anchorage. The head of the screw must be less than 2 mm thick.

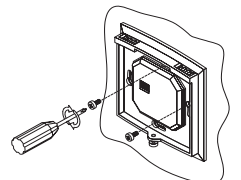

- 6 BEFORE installing the control module onto the base, set the configuration switches (if any) on the control module (refer to the user guide).

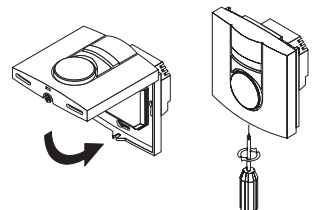

WARNING: This power base must be used **only** with **15-minute** heating cycles. If your control module has a selector switch for choosing the heating cycle, ensure that the switch is correctly set.

- 7 Return power to the heating system.

AUBE TECHNOLOGIES INC. TWO (2) YEAR LIMITED WARRANTY

This product is guaranteed against workmanship defects for a two-year period following the initial date of purchase. During this period, AUBE Technologies Inc. will repair or replace, at our option and without charge, any defective product which has been used under normal conditions.

The warranty does not cover delivery costs and does not apply to products poorly installed or randomly damaged following installation. This warranty cancels and replaces any other manufacturer's express or implied warranty as well as any other company commitment.

AUBE Technologies Inc. cannot be held liable for related or random damages following the installation of this product. The defective product as well as the purchase invoice must be returned to the place of purchase or mailed, prepaid and insured, to the nearest location.