

inox
lighting innovators

7 DAY DELIVERY

inox *xpress* **7**

t: 0845 643 9533 e: sales@inox.co.uk

www.inox.co.uk

Series 01

System luminaires made of small aluminium profiles - elox

inoxpress **7**
7 DAY DELIVERY

Code:

- 01-050K-1054E, E

Variant:

- Recessed

Power:

- 1x 54W T5 G5

Accessories:

- 01-0003, N - straight connector
- 01-0008, E - end cap for recessed luminaires

Optic:

- Opal diffuser: LOR = 25%

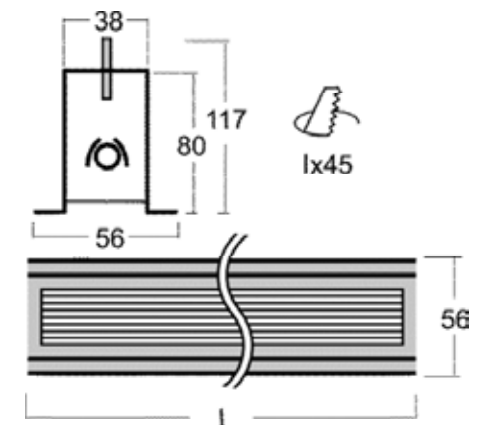
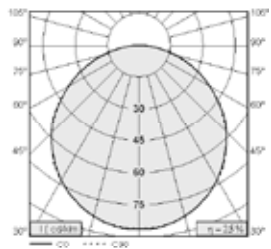
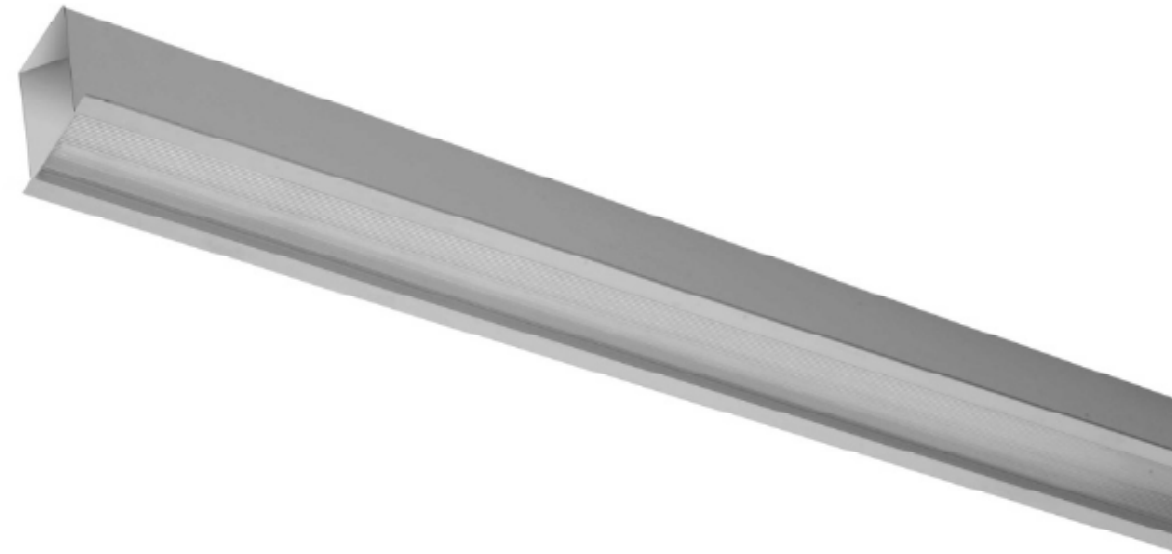

Series 01

System luminaires made of small aluminium profiles - elox

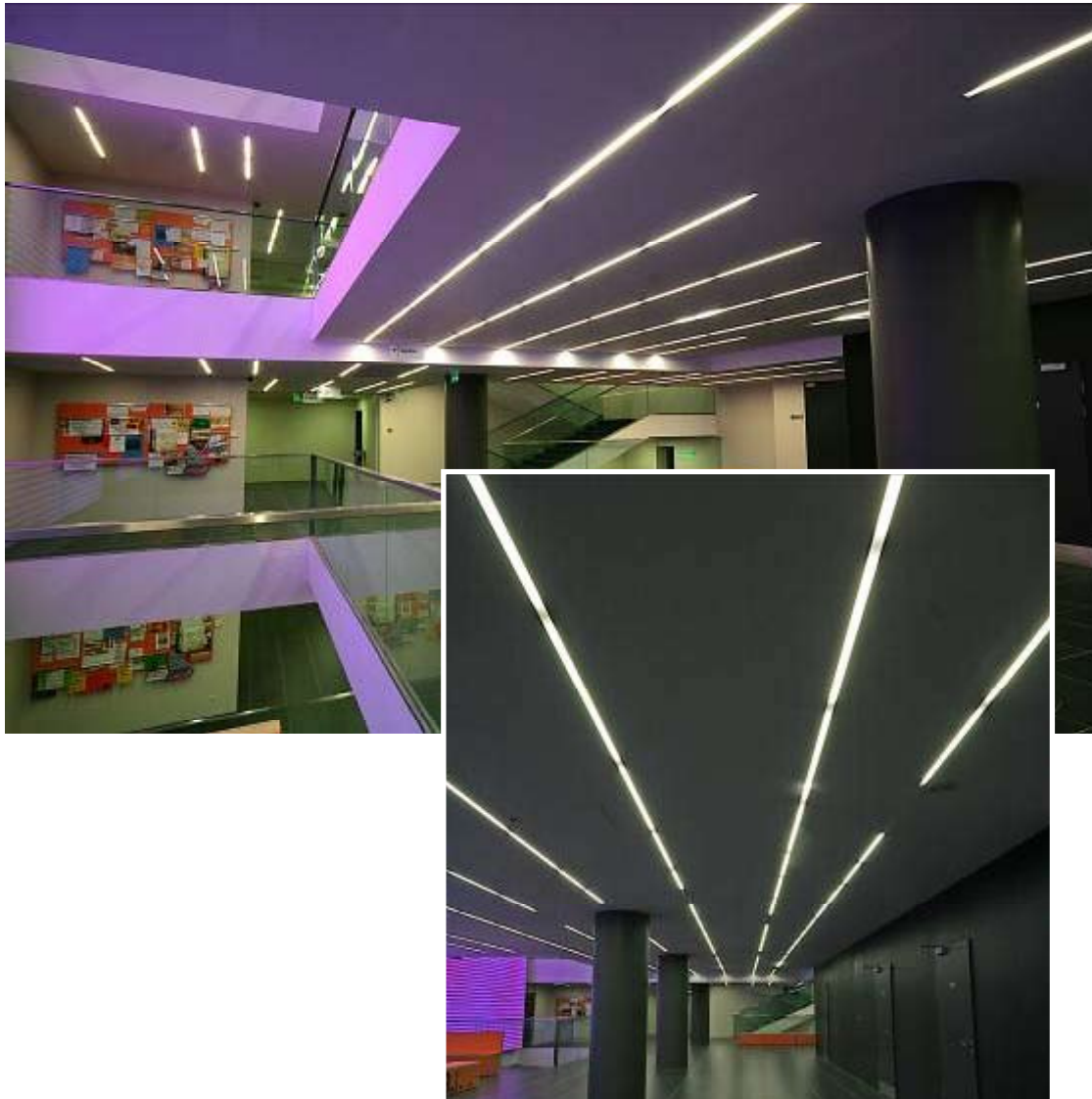

Series 01

System luminaires made of small aluminium profiles - elox

inoxpress ^{7 DAY DELIVERY}



Series 03

System luminaires made of aluminium profiles - elox

Code:

- 03-550A-1054E, E

Variant:

- Pendant/surface

Power:

- 1x 54W T5 G5

Accessories:

- 01-0003, N - straight connector
- 03-0006, E - end cap for pendant luminaires
- 03-0007, N - wire suspension 2000mm

Optic:

Parabolic louvre: LOR = 70%, L < 200cd/m²

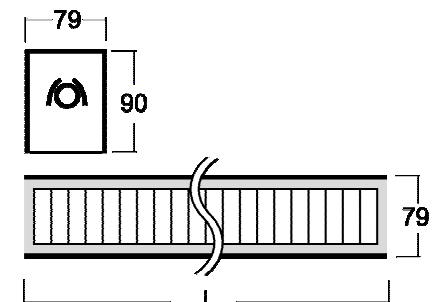
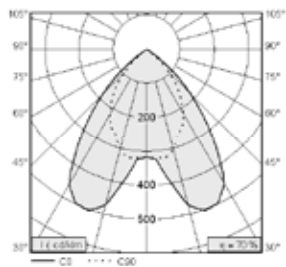

Series 03

System luminaires made of aluminium profiles - elox

inoxpress ^{7 DAY DELIVERY}



Series 03

System luminaires made of aluminium profiles - elox

inoxpress ^{7 DAY DELIVERY}

Code:

- Single and double electric units for HO lamps
- Single and double profiles

Variant:

- Pendant/surface
- Recessed

Accessories:

- 01-0003, N - straight connector
- 03-0003, E - 'L' coupler - pendant
- 03-0006, E - end cap for pendant luminaires
- 03-0007, N - wire suspension 2000mm
- 03-0018, E - end cap for recessed luminaires
- 03-0029, E - 'L' coupler - recessed

Optic:

- Opal diffuser PMMA: LOR = 39%

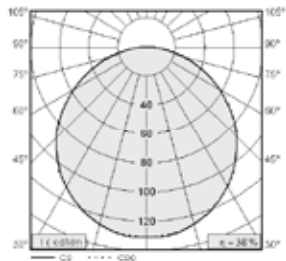
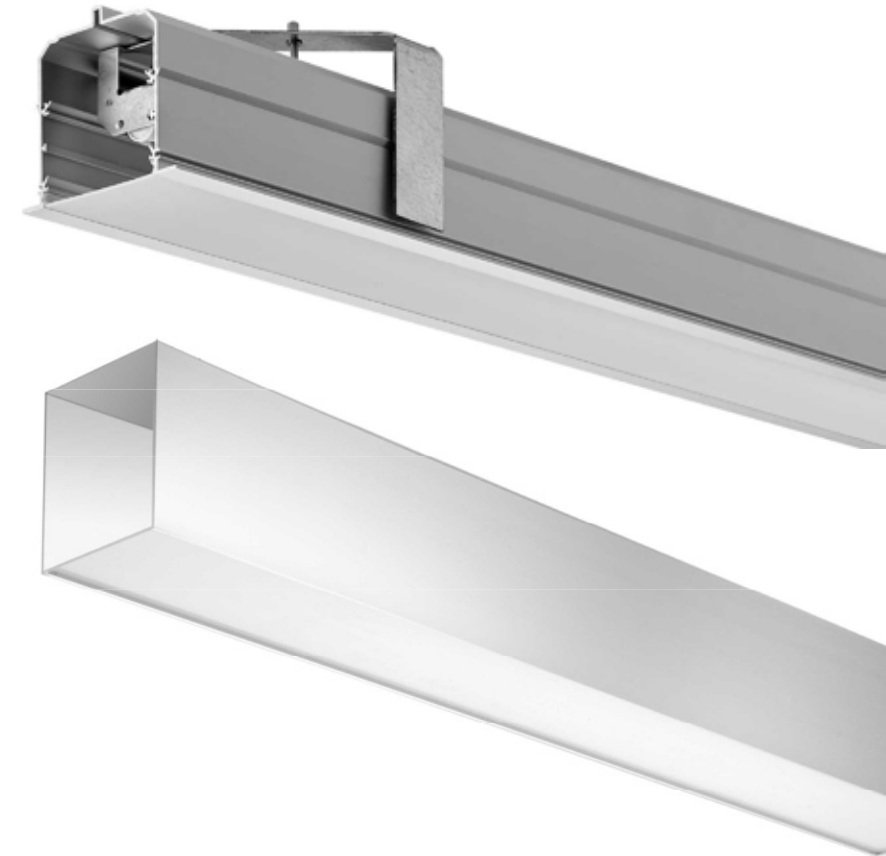

Series 03

System luminaires made of aluminium profiles - elox

inoxpress ^{7 DAY DELIVERY}

Electric module

Electric units:

- 1 x T5 24, 39, 54 and 80W
- 2 x T5 24, 39, 54 and 80W (double)

Profile:

- Start / independent
- Continuous
- Sizes profiles for 1 to 2 units
- Configuration of luminaires

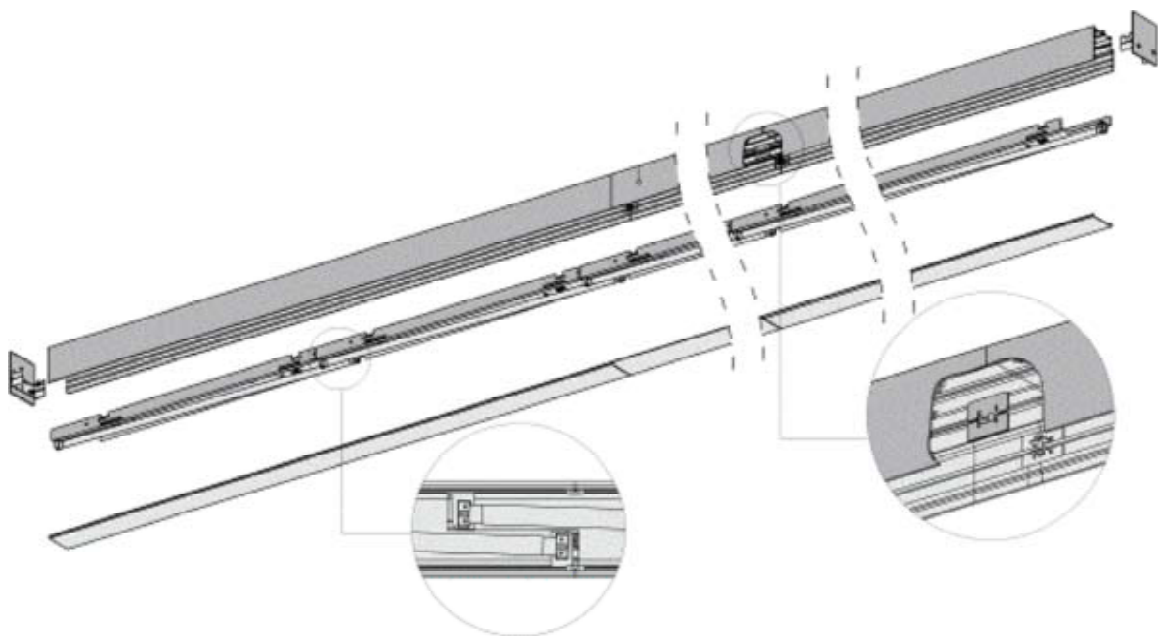

Series 03

System luminaires made of aluminium profiles - elox

inoxpress ^{7 DAY DELIVERY}



Series 03

System luminaires made of aluminium profiles - elox

inoxpress ^{7 DAY DELIVERY}

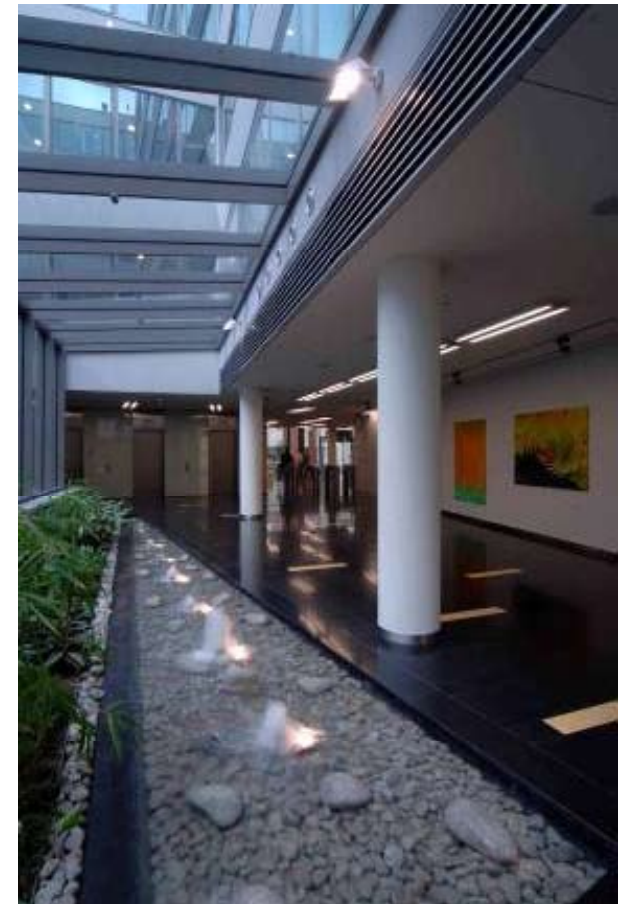

Series 03

System luminaires made of aluminium profiles - elox

inoxpress ^{7 DAY DELIVERY}



Series 03

System luminaires made of aluminium profiles - elox

inoxpress ^{7 DAY DELIVERY}



Series 10

System luminaires made of aluminium profiles - elox

Code:

- 10-571A-2054E-P, E
- 10-551K-2054E-P, E
- 10-550N-1100R-P, E

Variant:

- Pendant

Power:

- 2x 54W T5 G5

Accessories:

- 10-0002, N - straight connector
- 10-0003, E - 'L' coupler
- 10-0006, N - wire suspension 2000mm, 'Y' shaped
- 10-0007, E - profile end cap

Optic:

- Parabolic louvre: LOR = 93%, $L < 1000\text{cd/m}^2$
- Opal diffuser: LOR = 82%, $L < 1000\text{cd/m}^2$

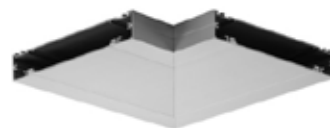
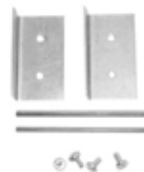
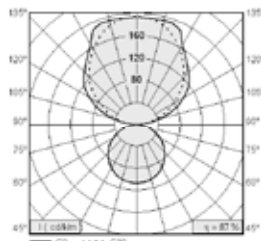
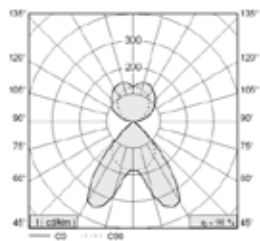

Series 10

System luminaires made of aluminium profiles - elox

inoxpress ^{7 DAY DELIVERY}



Series 10

System luminaires made of aluminium profiles - elox

inoxpress ^{7 DAY DELIVERY}



Series 10

System luminaires made of aluminium profiles - elox

inoxpress ^{7 DAY DELIVERY}



Series 13

Luminaires made of aluminium profiles - anodised

Code:

- 13-200K-4024E, E
- 13-240K-2024E, E
- 13-250K-1V1UE, E

Variant:

- Surface/pendant

Power:

- 4x 24W T5 G5
- 2x 24W TC-L 2G11
- 1x 22W + 1x 40W T16-R 2GX13

Accessories:

- 13-0001, S - wire suspension kit for square luminaires
- 13-0002, S - wire suspension kit for round luminaires

Optic:

- Opal diffuser: LOR = 56-61%

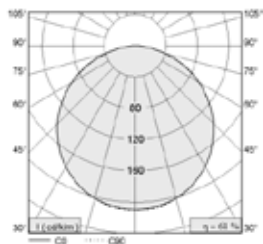
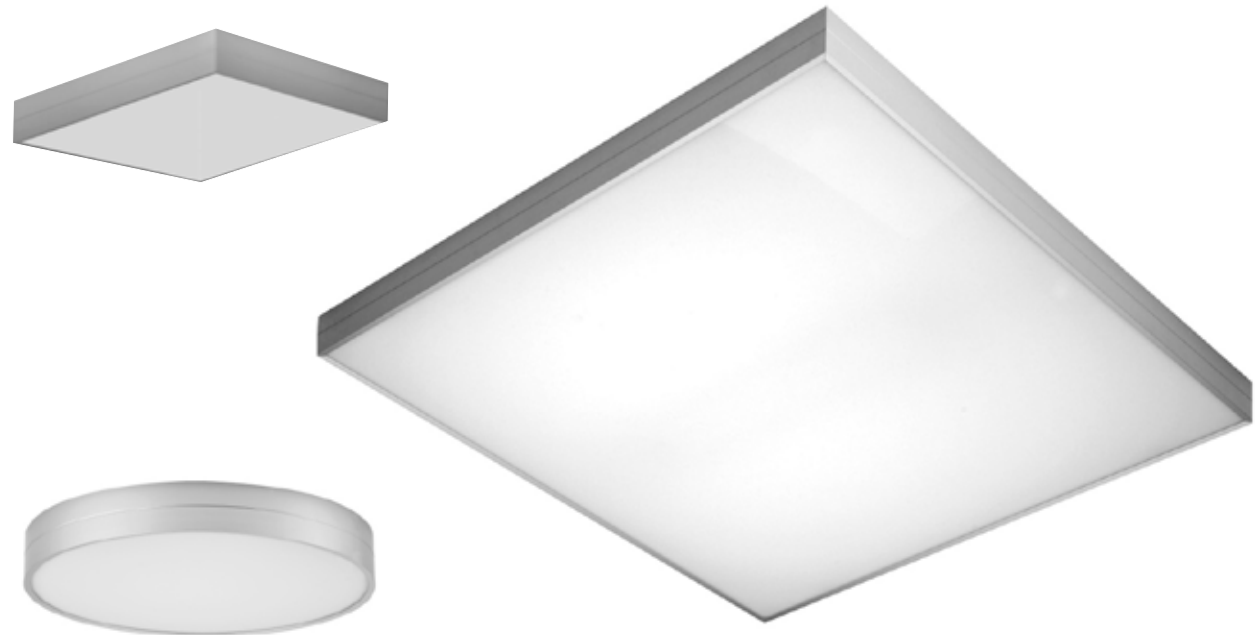

Series 13

Luminaires made of aluminium profiles - anodised

inoxpress **7**
7 DAY DELIVERY

Code:

- 13-511A-2054E, EB
- 13-511A-2054E, EW

Variant:

- Pendant

Power:

- 2x 54W T5 G5

Optic:

- Parabolic louvre: LOR = 92%, L < 1000cd/m²

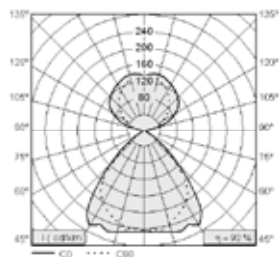
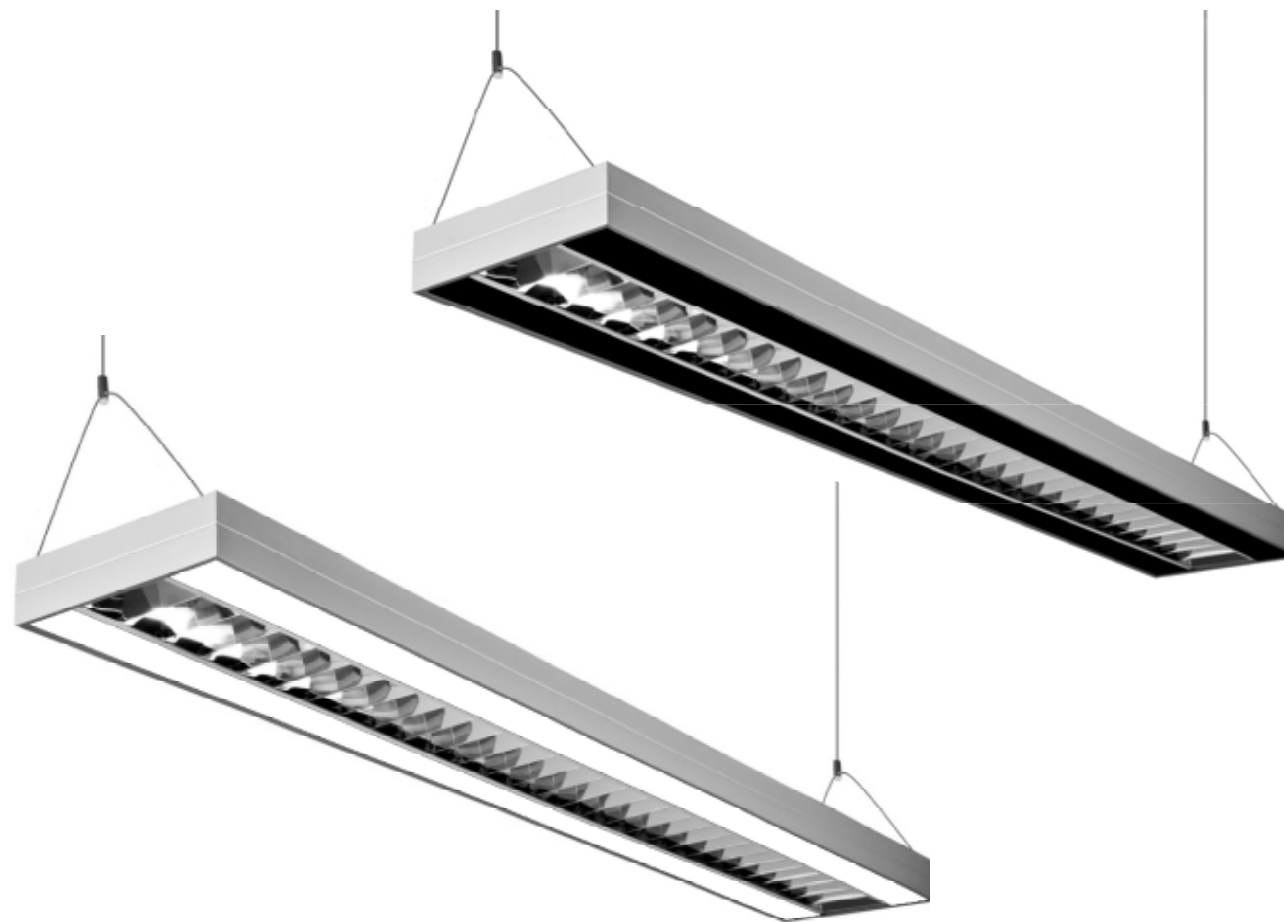

Series 13

Luminaires made of aluminium profiles - anodised

inoxpress **7**
7 DAY DELIVERY



Series 13

Luminaires made of aluminium profiles - anodised

inoxpress **7**
7 DAY DELIVERY



Series 13

Luminaires made of aluminium profiles - anodised

inoxpress ^{7 DAY DELIVERY}



Series 21

inoxpress 7 DAY DELIVERY

Luminaires for accent illumination made from powder coated steel sheet - structural silver

Code:

- 21-000N-1100R, S
- 21-000N-2100R, S
- 21-001N-1, S
- 21-001N-2, S

Variant:

- Recessed

Power:

- 1-2x 100W max. QR 111 G53
- 1-2x 35W and 70W HIPAR 111 GX8,5

Electric units:

- 70-0004I - for metal halide lamps 1x35W, connection E
- 70-0005I - for metal halide lamps 1x70W, connection E
- 70-0011I - for metal halide lamps 2x35W, connection E
- 70-0012I - for metal halide lamps 2x70W, connection E



Series 21

inoxpress **7**
7 DAY DELIVERY

Luminaires for accent illumination made from powder coated steel sheet - elox

Code:

- 21-540N-4100R, E

Variant:

- Pendant

Power:

- 4x 100W max. QR 111 G53



Series 21

Luminaires for accent illumination made from powder coated steel sheet - elox



Series 21

Luminaires for accent illumination made from powder coated steel sheet - elox



Series 50

Recessed plastic luminaire - white

inoxpress **7**
7 DAY DELIVERY

Code:

- 50-005P-2018E, W - electronic ballast
- 50-005P-2018K, W - magnetic ballast
- 50-005P-2026E, W - electronic ballast
- 50-005P-2026K, W - magnetic ballast

Variant:

- Recessed

Power:

- 2x 18W TC-D/TC-DEL
- 2x 26W TC-D/TC-DEL

Accessories:

- 50-020N - radial louvre
- 50-050N - polycarbonate opal cover, IP440

Optic:

- Without accessories: LOR = 72%
- Radial louvre: LOR = 48%
- Opal diffuser: LOR = 47%

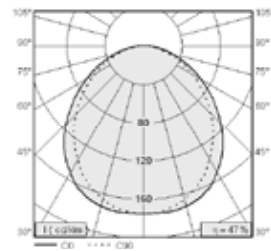
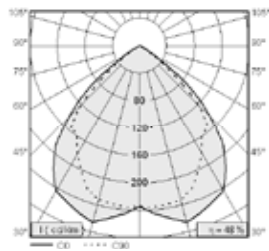
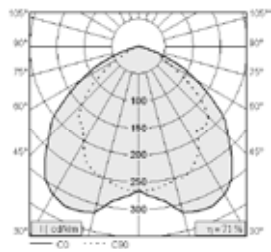

Series 50

Recessed plastic luminaire - white

inoxpress ^{7 DAY DELIVERY}



Series 66

Square recessed luminaires made from aluminium frame - anodised

Code:

- 66-003L-2018E, E
- 66-003L-2018K, E

Variant:

- Recessed

Power:

- 2x 18W TC-DEL
- 2x 26W TC-DEL

Accessories:

- 66-0002, W - opal cover, IP40

Optic:

- Without accessories: LOR = 62%
- Opal diffuser: LOR = 34%

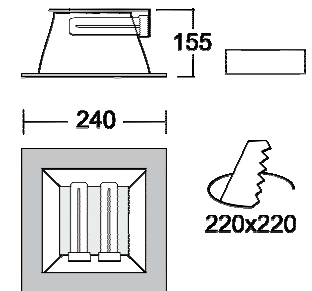
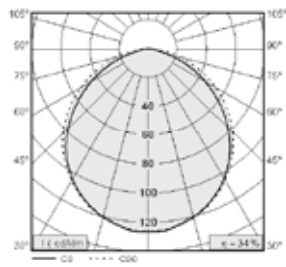
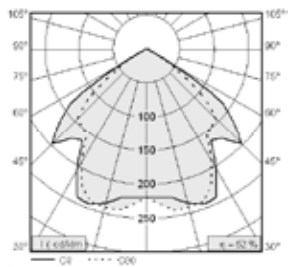
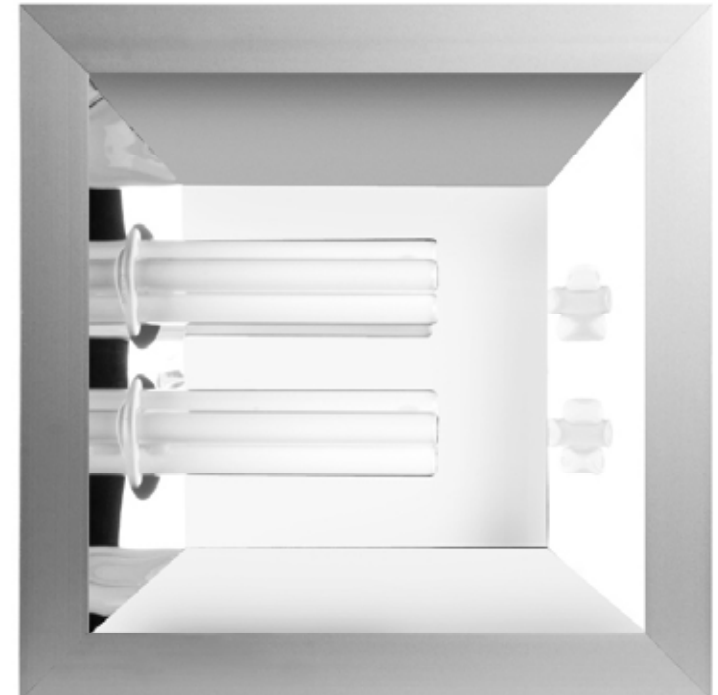

Series 66

Square recessed luminaires made from aluminium frame - anodised

inoxpress ^{7 DAY DELIVERY}



Series 66

Square recessed luminaires made from aluminium frame - anodised

inoxpress **7**
7 DAY DELIVERY





Inox Technical Lighting Ltd.
Unit 22 Brookside Centre
Sumpters Way, Temple Farm Industrial Estate
Southend-on-Sea SS2 5RR

t: 0845 643 9533 | e: sales@inox.co.uk

www.inox.co.uk