

CERAMIC & TRIMLESS DOWNLIGHTS

Ceram, Artus & Jazz Series

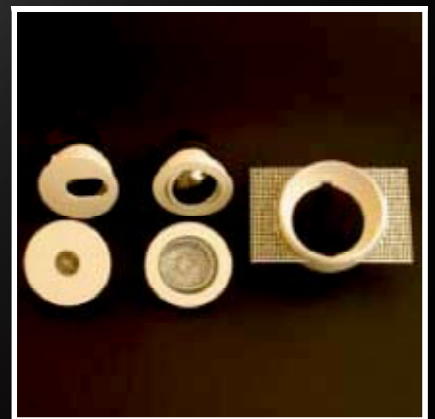

inox lighting
innovators

t +44(0)845 643 9533 f +44(0)845 280 1651 e sales@inox.co.uk w inox.co.uk

Ceram 3S



The light housing CERAM 3S is suitable for installation in plasterboard ceilings of 12mm thickness. It is made of cast ceramic material with an inner downlight component of cast aluminium. Versions are offered for 12V halogen, 230V halogen or LED and compact metal halide lamps.

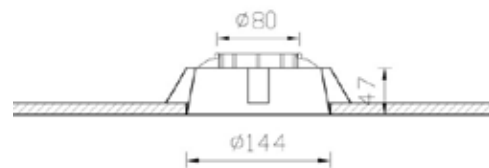

Lamps:



ES 50, max 50W, GU10, 230V
HALOGEN LAMP



QR-CBC 51, max 50W, GU5.3, 12V
HALOGEN LAMP WITH
DICHROIC REFLECTOR

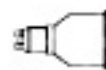

CFL, max 9W, GU10, 230V
COMPACT FLUORESCENT LAMP
/ 9W TOSHIBA LED



ES 50, max 35W, GX10
METAL HALIDE LAMP, BRITESPOT

Colours: Uncoloured



EN ISO 9001 : 2008



Design Production & Commerce of Lighting Products
Application Study of lighting System



ISO 14001 : 2004 + Cor1 : 2009



inox lighting
innovators

t +44(0)845 643 9533 f +44(0)845 280 1651

e sales@inox.co.uk w inox.co.uk

Ceram 3S 2F



The light housing CERAM 3S2F is suitable for installation in plasterboard ceilings of 12mm thickness. It is made of cast ceramic material with an inner downlight component of cast aluminium. Versions are offered for 12V halogen, 230V halogen or LED and compact metal halide lamps.

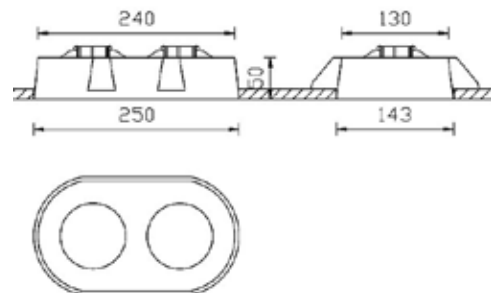

Lamps:

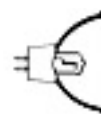

QR-CBC 51, max 50W,
GU5.3, 12V
HALOGEN LAMP WITH
DICHROIC REFLECTOR



ES 50, max 50W, GU10, 230V
HALOGEN LAMP

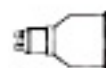

CFL, max 9W, GU10, 230V
COMPACT FLUORESCENT LAMP
/ 9W TOSHIBA LED



ES 50, max 35W, GX10
METAL HALIDE LAMP, BRITESPOT

Colours: Uncoloured



EN ISO 9001 : 2008



Design Production & Commerce of Lighting Products
Application Study of lighting System



ISO 14001 : 2004 + Cor1 : 2009



inox lighting
innovators

t +44(0)845 643 9533 f +44(0)845 280 1651

e sales@inox.co.uk w inox.co.uk

Ceram 4S



The light housing CERAM 4S is suitable for installation in plasterboard ceilings of 12mm thickness. It is made of cast ceramic material with an inner downlight component of cast aluminium. Versions are offered for 12V halogen, 230V halogen or LED and compact metal halide lamps.

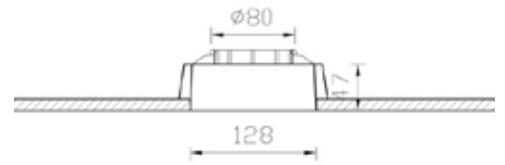

Lamps:

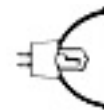

QR-CBC 51, max 50W, GU5.3, 12V
HALOGEN LAMP WITH
DICHROIC REFLECTOR



ES 50, max 50W, GU10, 230V
HALOGEN LAMP

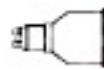

CFL, max 9W, GU10, 230V
COMPACT FLUORESCENT LAMP
/ 9W TOSHIBA LED



ES 50, max 35W, GX10
METAL HALIDE LAMP, BRITESPOT

Colours: Uncoloured



EN ISO 9001 : 2008
Design Production & Commerce of Lighting Products
Application Study of lighting System



inox lighting
innovators

t +44(0)845 643 9533 f +44(0)845 280 1651

e sales@inox.co.uk w inox.co.uk

Ceram 4S 2F



The light housing CERAM 4S2F is suitable for installation in plasterboard ceilings of 12mm thickness. It is made of cast ceramic material with an inner downlight component of cast aluminium. Versions are offered for 12V halogen, 230V halogen or LED and compact metal halide lamps.

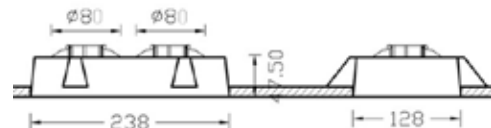

Lamps:



QR-CBC 51, max 50W, GU5.3, 12V
HALOGEN LAMP WITH
DICHROIC REFLECTOR



ES 50, max 50W, GU10, 230V
HALOGEN LAMP

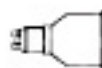

CFL, max 9W, GU10, 230V
COMPACT FLUORESCENT LAMP
/ 9W TOSHIBA LED



ES 50, max 35W, GX10
METAL HALIDE LAMP, BRITESPOT

Colours: Uncoloured



EN ISO 9001 : 2008



Design Production & Commerce of Lighting Products
Application Study of lighting System



ISO 14001 : 2004 + Cor1 : 2009



inox lighting
innovators

t +44(0)845 643 9533 f +44(0)845 280 1651

e sales@inox.co.uk w inox.co.uk

Artus 1



The luminaire ARTUS 1 is suitable for plasterboard ceilings. It is made of cast aluminium and fits flush for a trimless appearance. Four inner housings are available, offering choice of fixed, adjustable, pinhole and adjustable pinhole styles. Versions are available of 230V and 12V halogen or LED lamps.

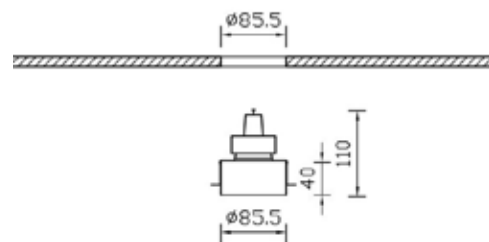

Lamps:



QR-CBC 51, max 50W, GU5.3, 12V HALOGEN LAMP WITH DICHROIC REFLECTOR



ES 50, max 50W, GU10, 230V HALOGEN LAMP



ES50 LED / 9W TOSHIBA LED

Colours: White, black & grey



Design Production & Commerce of Lighting Products
Application Study of lighting System



inox lighting
innovators

t +44(0)845 643 9533 f +44(0)845 280 1651

e sales@inox.co.uk w inox.co.uk

Artus Square 1

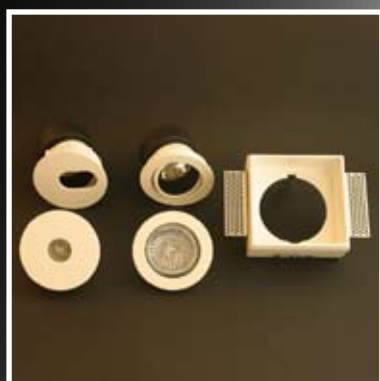

The luminaire ARTUS SQUARE 1 is suitable for plasterboard ceilings. It is made of cast aluminium and fits flush for a trimless appearance. Four inner housings are available, offering choice of fixed, adjustable, pinhole and adjustable pinhole styles. Versions are available of 230V and 12V halogen or LED lamps.

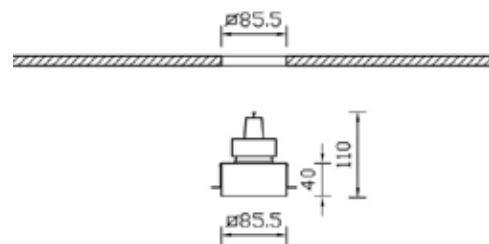

Lamps:



QR-CBC 51, max 50W, GU5.3, 12V HALOGEN LAMP WITH DICHROIC REFLECTOR



ES 50, max 50W, GU10, 230V HALOGEN LAMP



ES50 LED / 9W TOSHIBA LED

Colours: White, black & grey



Design Production & Commerce of Lighting Products
Application Study of lighting System



inox lighting
innovators

t +44(0)845 643 9533 f +44(0)845 280 1651

e sales@inox.co.uk w inox.co.uk

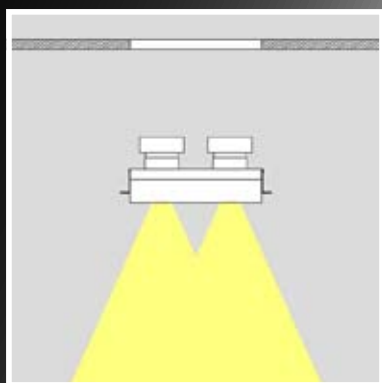

Orbis 2F

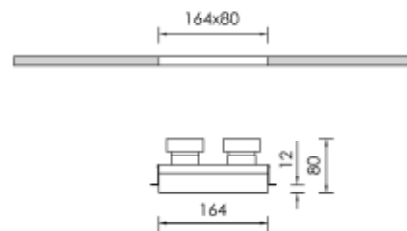

The luminaire ORBIS 2F is suitable for plasterboard ceilings and fits flush for a trimless appearance. It is made of cast aluminium and has a holder system of two steel strings. Two inner bodies may be selected from fixed, adjustable, pinhole and adjustable pinhole options. Versions are available for 230V and 12V halogen and LED lamps.



Lamps:

-  CFL, max 50W, GU10, 230V
COMPACT FLUORESCENT LAMP
-  ES 50, max 50W, GU10, 230V
HALOGEN LAMP
-  QR-CBC 51, max 50W, GU5.3, 12V
HALOGEN LAMP WITH
DICHROIC REFLECTOR
-  ES50 LED

Colours: White, black & grey



inox lighting
innovators

t +44(0)845 643 9533 f +44(0)845 280 1651
e sales@inox.co.uk w inox.co.uk



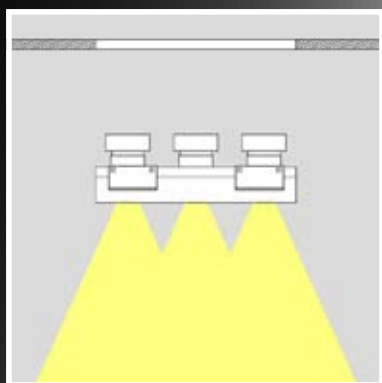

Orbis 3F

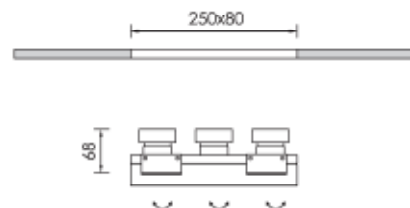

The luminaire ORBIS 3F is suitable for plasterboard ceilings and fits flush for a trimless appearance. It is made of cast aluminium and has a holder system of two steel strings. Two inner bodies may be selected from fixed, adjustable, pinhole and adjustable pinhole options. Versions are available for 230V and 12V halogen and LED lamps.

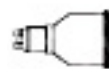

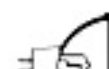
Lamps:

-  CFL, max 50W, GU10, 230V
COMPACT FLUORESCENT LAMP
-  ES 50, max 50W, GU10, 230V
HALOGEN LAMP
-  QR-CBC 51, max 50W, GU5.3, 12V
HALOGEN LAMP WITH
DICHROIC REFLECTOR
-  ES50 LED

Colours: White, black & grey



inox lighting
innovators

t +44(0)845 643 9533 f +44(0)845 280 1651
e sales@inox.co.uk w inox.co.uk

Ceram 3



The light housing CERAM 3 is suitable for installation in plasterboard ceilings of 12mm thickness. It is made of cast ceramic material with an inner downlight component of cast aluminium. Versions are offered for 12V halogen, 230V halogen or LED and compact metal halide lamps.

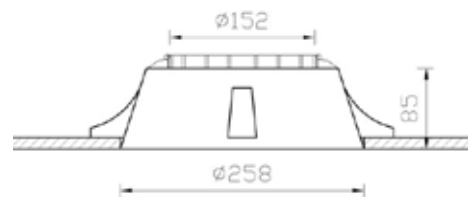

Lamps:



HIT, max 150W, G12
METAL HALIDE LAMP



QR 111, max 100W, G53, 12V
HALOGEN LAMP



PAR 36, max 50W, M4, 12V
HALOGEN LAMP



CDM R111, max 70W, GX8.5
METAL HALIDE LAMP



HCI T, max 70W, G8.5
METAL HALIDE LAMP



QT 18, max 150W, B15d, 230V
HALOGEN LAMP



ES 111, max 75W, GU10, 230V
HALOGEN LAMP

Colours: Uncoloured



Design Production & Commerce of Lighting Products
Application Study of lighting System



inox lighting
innovators

t +44(0)845 643 9533 f +44(0)845 280 1651

e sales@inox.co.uk w inox.co.uk

Ceram 3L



The light housing CERAM 3 is suitable for installation in plasterboard ceilings of 12mm thickness. It is made of cast ceramic material with an inner downlight component of cast aluminium. Versions are offered for 12V halogen, 230V halogen or LED and compact metal halide lamps.

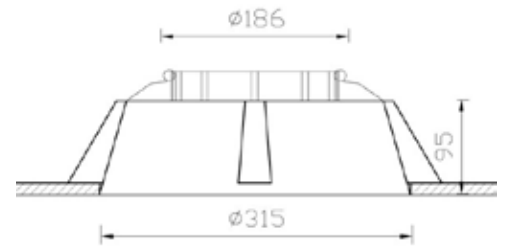

Lamps:



HIT, max 150W, G12
METAL HALIDE LAMP



TC-DE, max 2x32W, 4Pins, G24q
COMPACT FLUORESCENT LAMP



TC-D, max 2x26W, 2Pins, G24d
COMPACT FLUORESCENT LAMP



QT DE 12, max 300W, R7s,
230V, 118mm
HALOGEN LAMP



HIT DE, max 150W, RX7s
METAL HALIDE LAMP

Colours: Uncoloured



inox lighting
innovators

t +44(0)845 643 9533 f +44(0)845 280 1651

e sales@inox.co.uk w inox.co.uk

Ceram 4M



The light housing CERAM 4M is suitable for installation in plasterboard ceilings of 12mm thickness. It is made of cast ceramic material with an inner downlight component of cast aluminium. Versions are offered for 12V halogen, 230V halogen or LED and compact metal halide lamps.

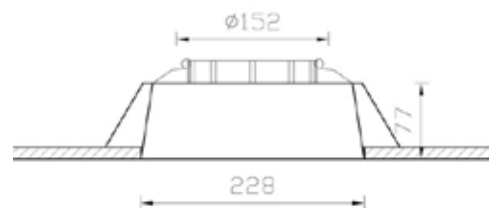

Lamps:



ES 111, max 75W, GU10, 230V
HALOGEN LAMP



QT 18, max 150W, B15d, 230V
HALOGEN LAMP



HCI T, max 70W, G8.5
METAL HALIDE LAMP



CDM R111, max 70W, GX8.5
METAL HALIDE LAMP



PAR 36, max 50W, M4, 12V
HALOGEN LAMP



QR 111, max 100W, G53, 12V
HALOGEN LAMP



HIT, max 150W, G12
METAL HALIDE LAMP

Colours: Uncoloured



EN ISO 9001 : 2008
Design Production & Commerce of Lighting Products
Application Study of lighting System



inox lighting
innovators

t +44(0)845 643 9533 f +44(0)845 280 1651

e sales@inox.co.uk w inox.co.uk

Ceram 4L



The light housing CERAM 4L is suitable for installation in plasterboard ceilings of 12mm thickness. It is made of cast ceramic material with an inner downlight component of cast aluminium. Versions are offered for 12V halogen, 230V halogen or LED and compact metal halide lamps.

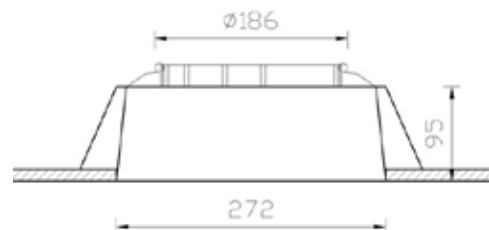

Lamps:



TC-DE, max 2x32W, 4Pins, G24q
COMPACT FLUORESCENT LAMP



TC-D, max 2x26W, 2Pins, G24d
COMPACT FLUORESCENT LAMP



QT DE 12, max 300W, R7s,
230V, 118mm
HALOGEN LAMP



HIT DE, max 150W, RX7s
METAL HALIDE LAMP



HIT, max 150W, G12
METAL HALIDE LAMP

Colours: Uncoloured



inox lighting
innovators

t +44(0)845 643 9533 f +44(0)845 280 1651

e sales@inox.co.uk w inox.co.uk

Jazz

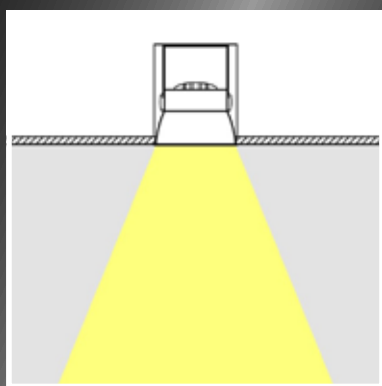

The luminaire JAZZ is suitable for plasterboard ceilings. It is made of cast aluminium. The inner part rotates and tilts. It operates at 230V/50-60Hz. Versions are available for 230V and 12V halogen and LED lamps.

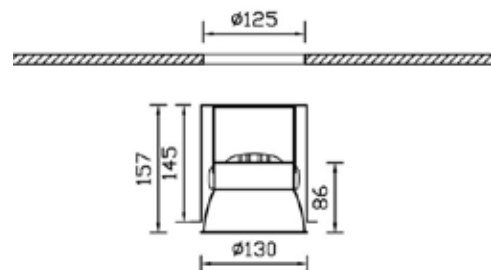

Lamps:



QR-CBC 51, max 50W, GU5.3, 12V
HALOGEN LAMP WITH
DICHROIC REFLECTOR



ES 50, max 50W, GU10, 230V
HALOGEN LAMP



ES 50, max 35W, GX10
METAL HALIDE LAMP, BRITESPOT

Colours: White, black & grey

inox lighting
innovators

t +44(0)845 643 9533 f +44(0)845 280 1651
e sales@inox.co.uk w inox.co.uk



Jazz Max

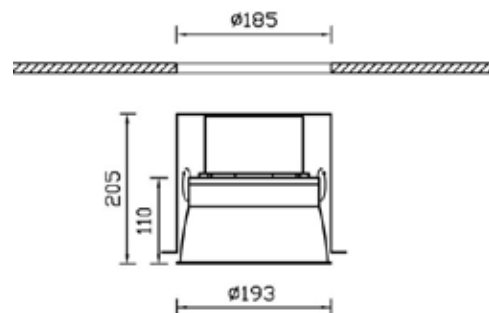

Lamps:



ES 111, max 75W, GU10, 230V
HALOGEN LAMP



PAR 36, max 50W, M4, 12V
HALOGEN LAMP



QR 111, max 100W, G53, 12V
HALOGEN LAMP



The luminaire JAZZ MAX is suitable for plasterboard ceilings. It is made of cast aluminium. The inner part rotates and tilts. It operates at 230V/50-60Hz. Versions are available for 230V and 12V halogen and LED lamps.

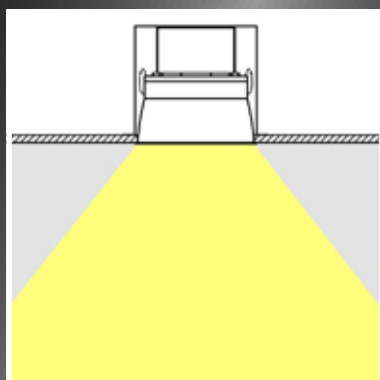

Colours: White, black & grey

inox lighting
innovators

t +44(0)845 643 9533 f +44(0)845 280 1651
e sales@inox.co.uk w inox.co.uk



EN ISO 9001 : 2008
Design Production & Commerce of Lighting Products
Application Study of lighting System



ISO 14001 : 2004 + Cor1 : 2009
Environmental Management System