



BLUEPRINT JOINERY
ONLINE JOINERY SOLUTIONS



CHESHIRE
mouldings

Love the home you're in

Decking Collection 2011



axxys DEK shown in Red Hardwood





Balustrades for a great outdoor experience

Cheshire Mouldings is the UK's leading manufacturer of outdoor balustrade components. We source only the finest quality timbers, from sustainable sources, to create fabulous decking solutions you'll be proud of season after season, year after year.

BenchMark Turned & Contemporary

Our outdoor ranges have something for every taste. From our **BenchMark** range, traditional turned, double reeded and stop chamfered designs bring classical elegance to any decking feature, whilst our expanding **axxys Dek** portfolio remains at the cutting edge of outdoor balustrade design with its use of toughened glass and cast metal details.

Quality that lasts

At Cheshire Mouldings we take just as much pride in our decking components as we do in our indoor stairparts and mouldings. That's why all our softwood balustrades come pre-treated with TANALITH E preservative to help protect your deck from the inside out. Other than pressure washing down and re-sealing once or twice a season, the only thing left to do with your deck is enjoy it.

Our red hardwood components are even easier to keep in great condition. Just a little decking oil once or twice a year will help prevent natural 'greying' and revitalise this beautiful timber.

Decking done the right way

As members of the Timber Decking Association we understand just how important good design and using the best materials can be for your decking project. Above all we understand that a good deck is a safe deck, which is why many of our balustrade systems are tested to BSBS6180:1999

Decks can also be substantial features in their own right and so our advice to homeowners and contractors alike is to always check with your local planning authority before you start your project.



Cheshire Mouldings & Woodturnings Ltd Unit 7, Normans Road, Sutton, St. Helens WA9 4JQ
Telephone +44 (0)1744 811 545 Fax +44(0)1744 811 475 Email enquiries@cheshiremouldings.co.uk
www.cheshiremouldings.co.uk
www.axxys.co.uk

© 2010 Cheshire Moulding & Woodturnings Ltd. For domestic use only. Stairparts have been tested by FIRA to BS6180:1999

For domestic use only. **axxys**® has been tested by FIRA to BS6180:1999

- 4 **axxys DEK** Stop Chamfered Softwood
- 6 **axxys DEK** Contemporary Softwood
- 8 **BenchMark** Bow & Eden Aluminium
- 10 **BenchMark** Turned Red Hardwood
- 12 **BenchMark** Stop Chamfered Red Hardwood
- 14 **axxys DEK** Stop Chamfered Red Hardwood
- 16 **axxys DEK** ClearView Softwood
- 18 **BenchMark** Stop Chamfered Softwood
- 19 **BenchMark** Double Reed Softwood
- 20 **BenchMark** Square Softwood
- 21 **BenchMark** Turned Softwood
- 22 **BenchMark** American Softwood
- 24 **BenchMark** Roman Softwood
- 26 **axxys DEK**² Squared Red Hardwood & Aluminium
- 28 Components



FSC Certification
FSC (Forest Stewardship Council) is an independent, not-for-profit organisation concerned with the responsible management of the world's forests.



PEFC Accreditation
PEFC promotes sustainable, socially beneficial and economically viable management of forests for present and future generations.





axxys® DEK

Stop Chamfered softWOOD

axxys dek is a contemporary range of decking products designed to inspire.

A modular system of pine timbers with metal and ABS components, **axxys dek** removes the rigid boundary between your indoor and outdoor spaces to create a complete living environment.

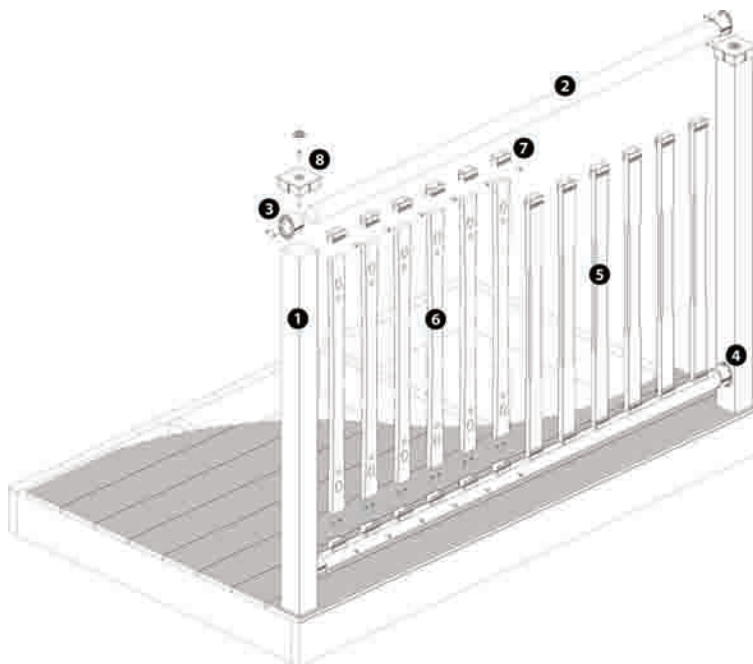

axxys DEK Stop chamfered softWOOD				
Product code	Description	Timber	Pk Qty	
1	ADNP13/ADNP15	axxys DEK Square newel post	Treated pine	1
2	ADRAIL1.8	axxys DEK Universal rail	Treated pine	1
3	ADHRCONA	axxys DEK Handrail connector	Zamac3	1 Pair
4	ADBRCONA	axxys DEK Baserail connector	Zamac3	1 Pair
5	ADSTB	axxys DEK Stop chamfered baluster	Treated pine	1
6	ADFTB	axxys DEK Fretted baluster	Treated pine	1
7	ADTBA	axxys DEK Baluster brackets	ABS	1 Pair
8	ADCAPA	axxys DEK Newel cap	ABS	1





axxys® DEK

Contemporary SOFTWOOD

Easy to install, use **axxys dek** to create a brand new decking feature from the ground up or to add modern touches to an existing deck platform.

Engineered to last, **axxys dek** is the contemporary choice for all seasons.

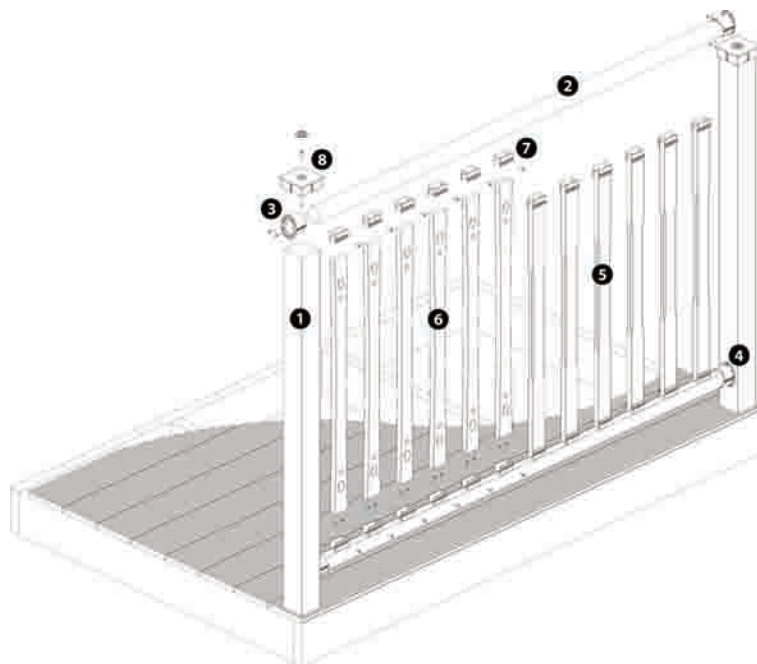

axxys DEK Contemporary SOFTWOOD				
Product code	Description	Timber	Pk Qty	
1	ADNP13/ADNP15	axxys DEK Square newel post	Treated pine	1
2	ADRAIL1.8	axxys DEK Universal rail	Treated pine	1
3	ADHRCONA	axxys DEK Handrail connector	Zamac3	1 Pair
4	ADBRCONA	axxys DEK Baserail connector	Zamac3	1 Pair
5	ADSTB	axxys DEK Stop chamfered baluster	Treated pine	1
6	ADFTB	axxys DEK Fretted baluster	Treated pine	1
7	ADTBA	axxys DEK Baluster brackets	ABS	1 Pair
8	ADCAPA	axxys DEK Newel cap	ABS	1





BenchMark

Bow & Eden ALUMINIUM

New for 2011 our Bow and Eden balusters are the perfect way to customise your decking project.

Their subtle curvatures give visual depth to your balustrade just as their jet-black finish adds another layer of texture to any garden.

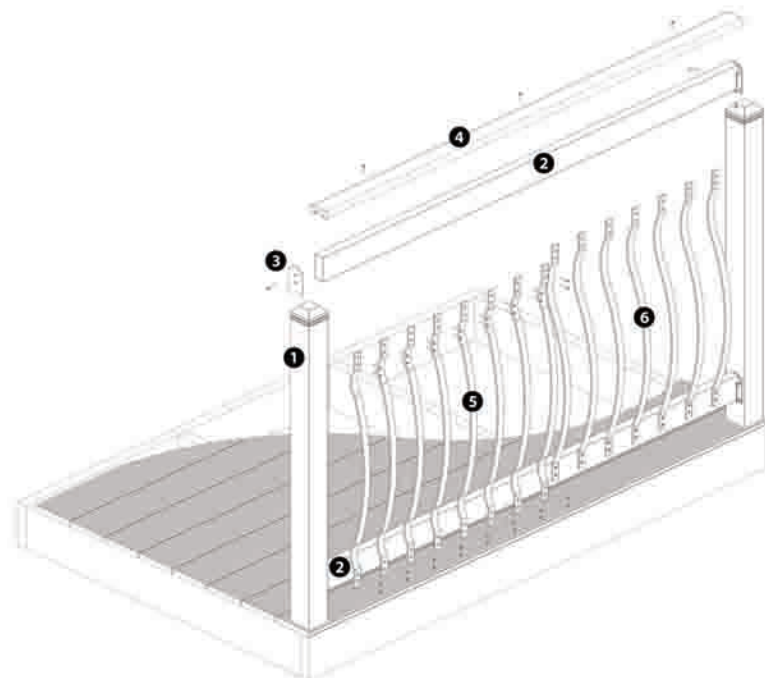
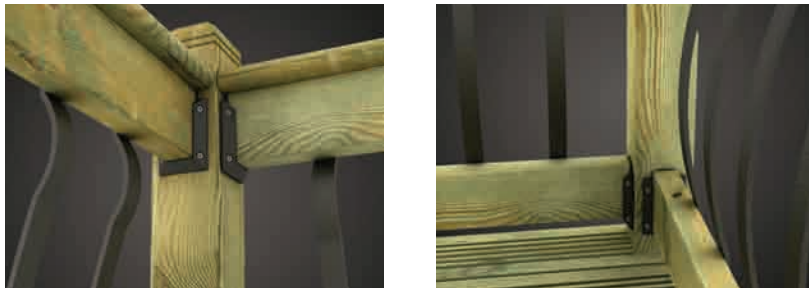

axxys DEK Bow & Eden ALUMINIUM

Product code	Description	Timber	Pk Qty
1 DEP12CB/DEP24CB	Benchmark Chamfered & Beaded newel	Treated pine	1
2 DCMR	Benchmark Metal baluster pine rail	Treated pine	1
3 DCVRB	Benchmark Rail fixing brackets	ABS	2
4 DCAP18	Benchmark Capping rail	Treated pine	1
5 DEK-BOW	Benchmark Metal balusters	Black powder coated	5
6 DEK-EDEN	Benchmark Metal balusters	Black powder coated	5





BenchMark

Turned RED HARDWOOD

Stunning is the only way to describe the red hardwood version of our traditional turned **BenchMark** range.

The colour. The feel. The quality. There's no better deck.

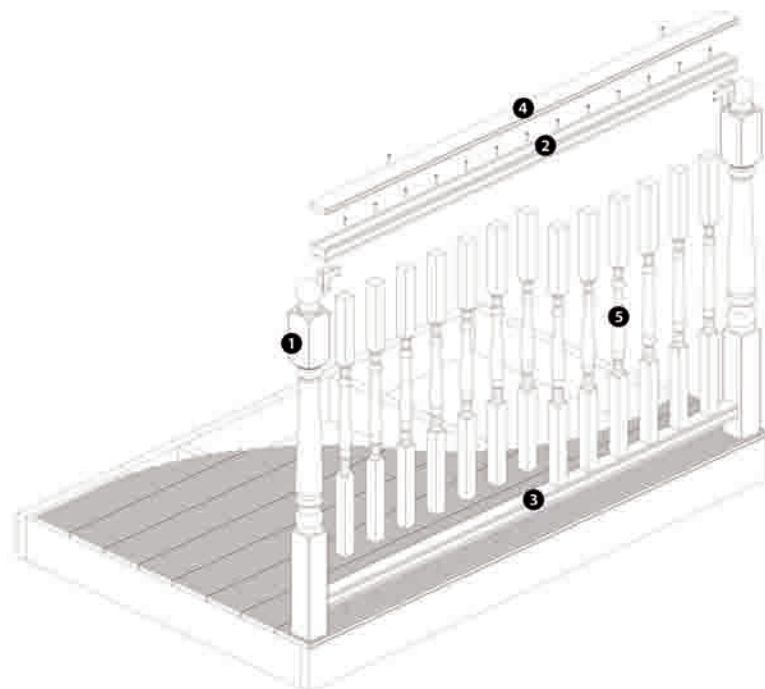

BenchMark Turned RED HARDWOOD

Product code	Description	Timber	Pk Qty
1 DEP15CAPM	Benchmark Turned newel post	Red hardwood	1
2 DHR1.2/1.8M	Benchmark Handrail	Red hardwood	1
3 DBR1.2/1.8M	Benchmark Baserail	Red hardwood	1
4 DCAP1.2/1.8M	Benchmark Handrail cap	Red hardwood	1
5 DED90M	Benchmark Turned spindle	Red hardwood	1





BenchMark

Stop Chamfered RED HARDWOOD

Stop chamfered is the perfect design for red hardwood.

Its simplicity lets us focus on the main attraction: one of nature's finest timbers and a species whose rightful place is the great outdoors.

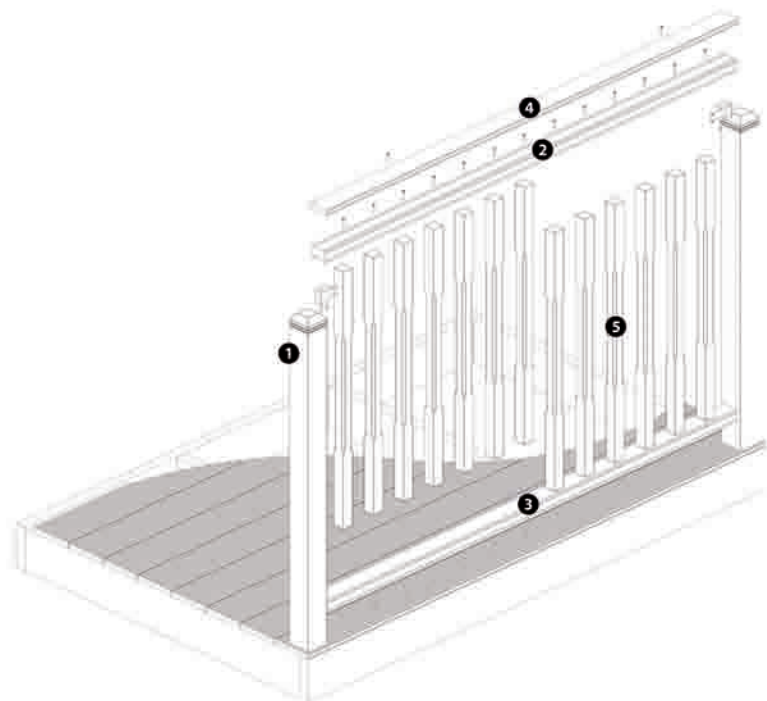

BenchMark Stop Chamfered RED HARDWOOD

Product code	Description	Timber	Pk Qty
1 DEP15CBM	BenchMark Chamfered & beaded newel	Red hardwood	1
2 DHR1.2/1.8M	BenchMark Hardwood rail	Red hardwood	1
3 DBR1.2/1.8M	BenchMark Hardwood baserail	Red hardwood	1
4 DCAP1.2/1.8M	BenchMark Rail cap	Red hardwood	1
5 DEDST9041M	BenchMark Stop chamfered spindle	Red hardwood	1





axxys® DEK

Stop Chamfered RED HARDWOOD

We didn't think it possible to make **axxys dek** any better.

Until we launched our red hardwood version that is!

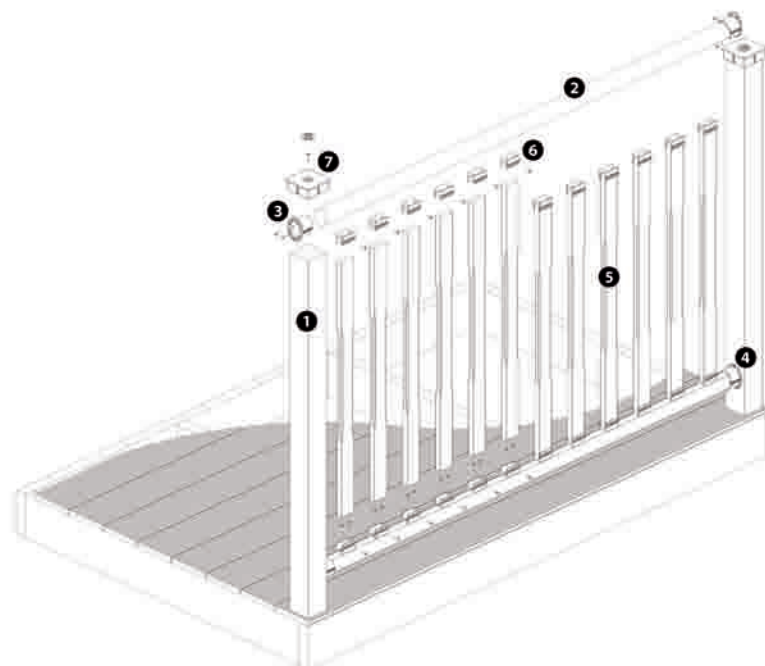

axxys DEK Stop Chamfered RED HARDWOOD

Product code	Description	Timber	Pk Qty	
1	ADNP15M	axxys DEK Square Newel post	Red hardwood	1
2	ADRAIL1.8M	axxys DEK Universal rail	Red hardwood	1
3	ADHRCONA	axxys DEK Handrail connector	Zamac3	1 Pair
4	ADBRCONA	axxys DEK Baserail connector	Zamac3	1 Pair
5	ADSTBM	axxys DEK Stop chamfered baluster	Red hardwood	1
6	ADTBA	axxys DEK Baluster brackets	ABS	1 Pair
7	ADCAPA	axxys DEK Newel cap	ABS	1





axxys® DEK

ClearView SOFTWOOD

ClearView blends the organic warmth of quality decking timbers with stunning glass balusters for a deck that blends traditional and contemporary.

The result is a brilliant frame to nature's perfect backdrop.

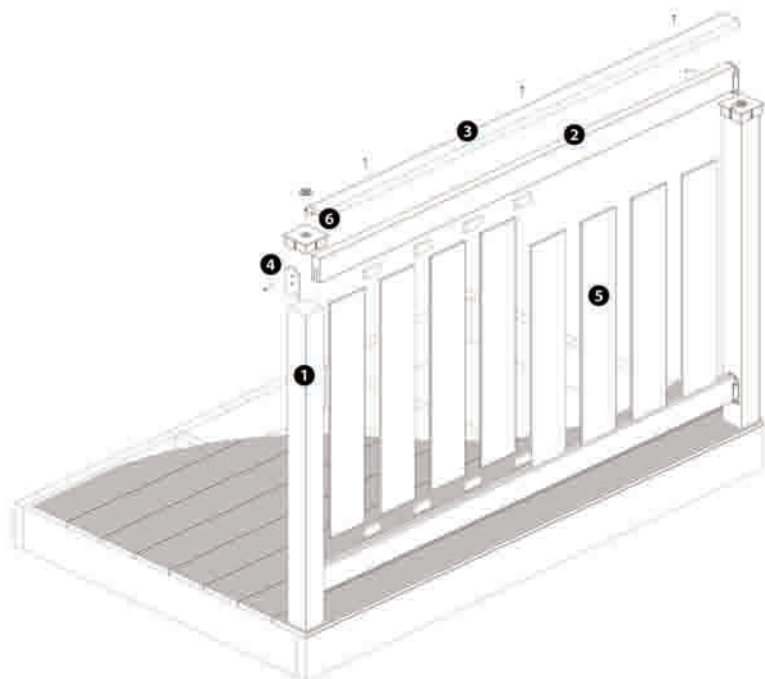

axxys DEK ClearView SOFTWOOD

Product code	Description	Timber	Pk Qty	
1	ADNP13/ADNP15	axxys DEK Square newel post	Treated pine	1
2	DCLRAIL	axxys DEK ClearView rail	Treated pine	1
3	DCAP18	axxys DEK ClearView capping rail	Treated pine	1
4	DCVRB	axxys DEK ClearView rail fixing brackets	ABS	1 Pair
5	DCLPAN	axxys DEK ClearView panels	Toughened glass	7
6	ADCAPA	axxys DEK Newel cap	ABS	1



BenchMark



Stop Chamfered softwood

The solidity of our stop chamfered range can take everything nature can throw at it and still look great as the sun goes down.

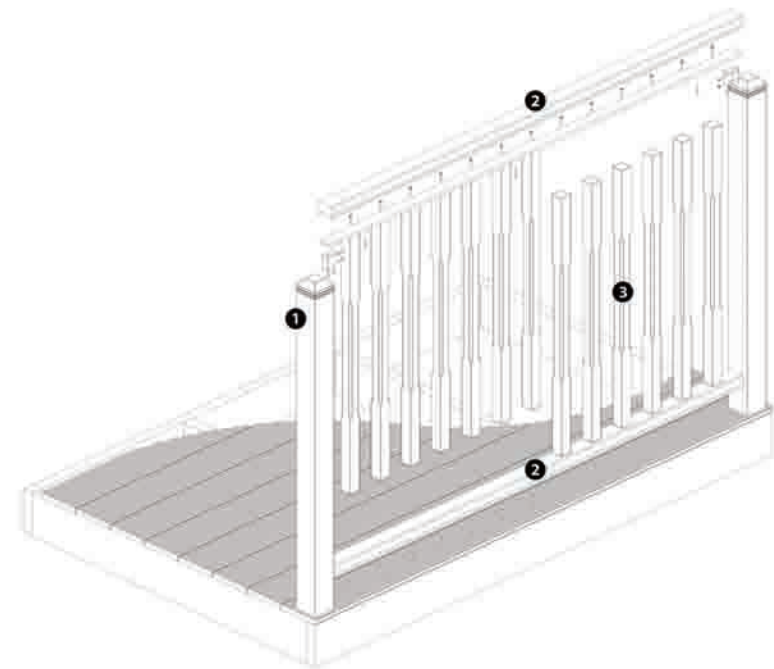

BenchMark Stop Chamfered softwood

	Product code	Description	Timber	Pk Qty
1	DEP12CB/DEP24CB	Benchmark Chamfered & beaded newel	Treated pine	1
2	DHU1.8/2.4	Benchmark Universal rail	Treated pine	1
3	DEDST9041P	Benchmark Stop chamfered baluster	Treated pine	1



BenchMark

Double Reed softwood

We take just as much pride in our decking components as we do in our indoor stairparts and mouldings.

That's why all our pine decking comes pre-treated with TANALITH E to help protect it from the inside out.

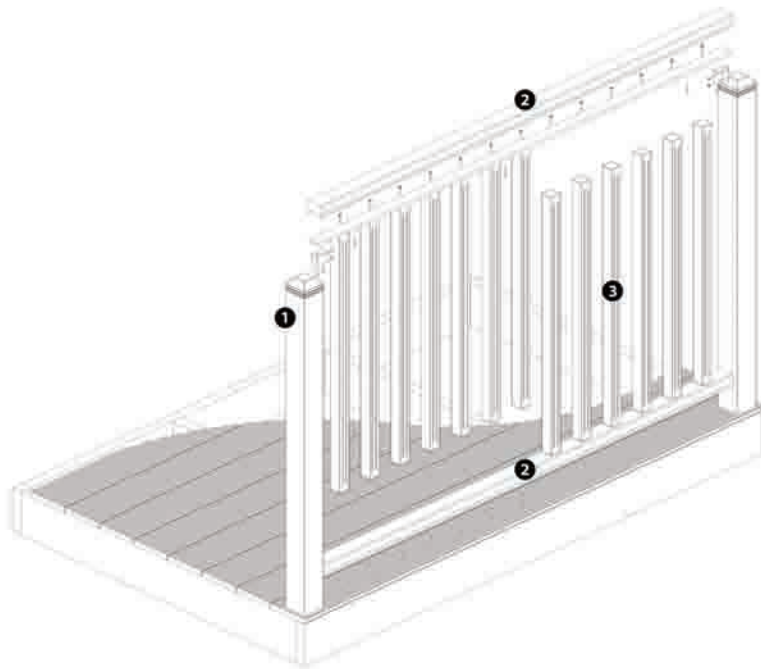

BenchMark Double Reed softwood

Product code	Description	Timber	Pk Qty
1 DEP12CB/DEP24CB	BenchMark Chamfered & beaded newel	Treated pine	1
2 DHU1.8/DHU2.4	BenchMark Universal rail	Treated pine	1
3 DECREED	BenchMark Double Reeded baulster	Treated pine	1



BenchMark



Square SOFTWOOD

For those that like to keep it simple our square blanks are just perfect.

They're also made from the same great quality pine as the rest of our decking range so there's no sacrificing quality even if the function's more important than the form.

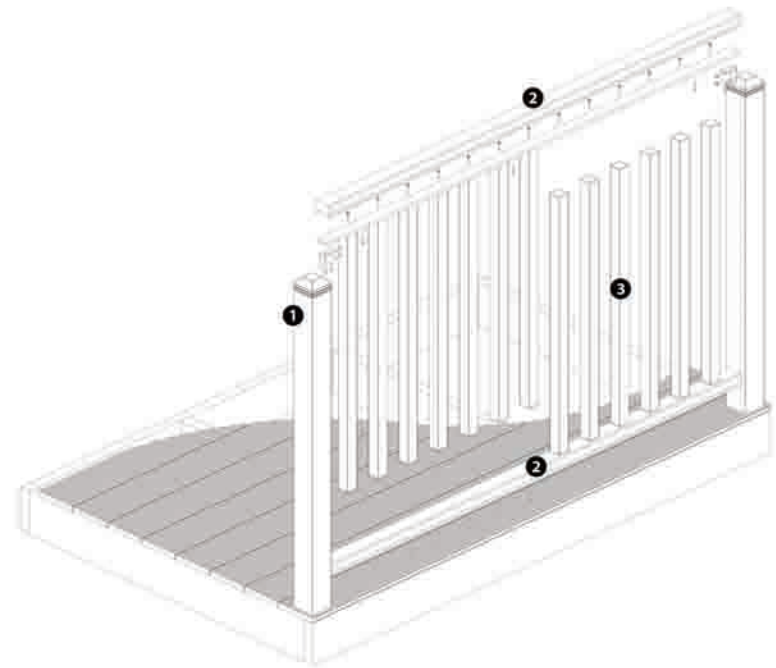

BenchMark Square SOFTWOOD

Product code	Description	Timber	Pk Qty
1 DEP12CB/DEP24CB	BenchMark Chamfered & beaded newel	Treated pine	1
2 DHU1.8/2.4	BenchMark Universal decking rail	Treated pine	1
3 41PBTR	BenchMark Treated deck blank	Treated pine	1



BenchMark

Turned SOFTWOOD

Seasons come and go but our turned decking range is a timeless classic.

It's also one of our most flexible designs and works beautifully in gardens of all shapes and sizes.

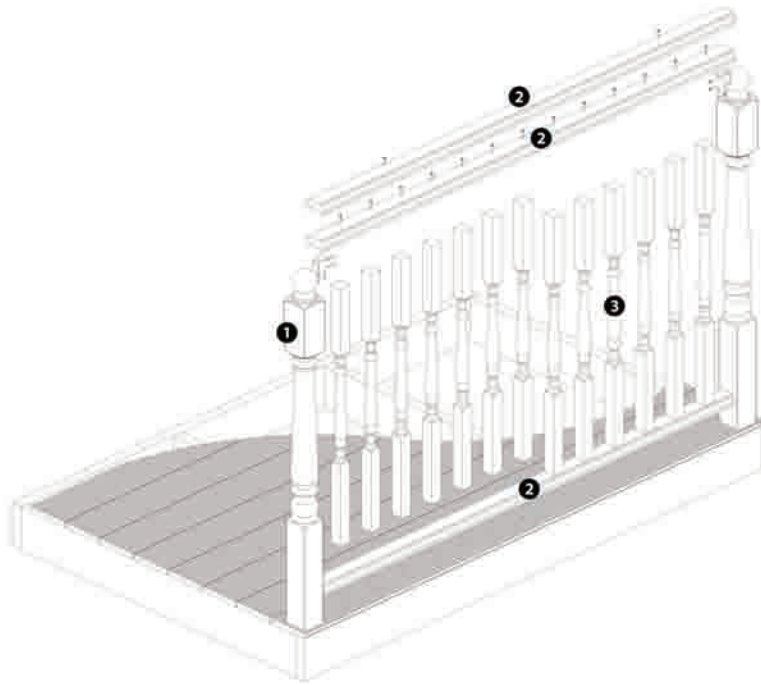

BenchMark Turned SOFTWOOD

Product code	Description	Timber	Pk Qty
1 DEP12CAP	Benchmark Turned newel	Treated pine	1
2 DHNEW1.8/2.4	Benchmark Double stack universal rail	Treated pine	1
3 DED90	Benchmark Turned spindle	Treated pine	1

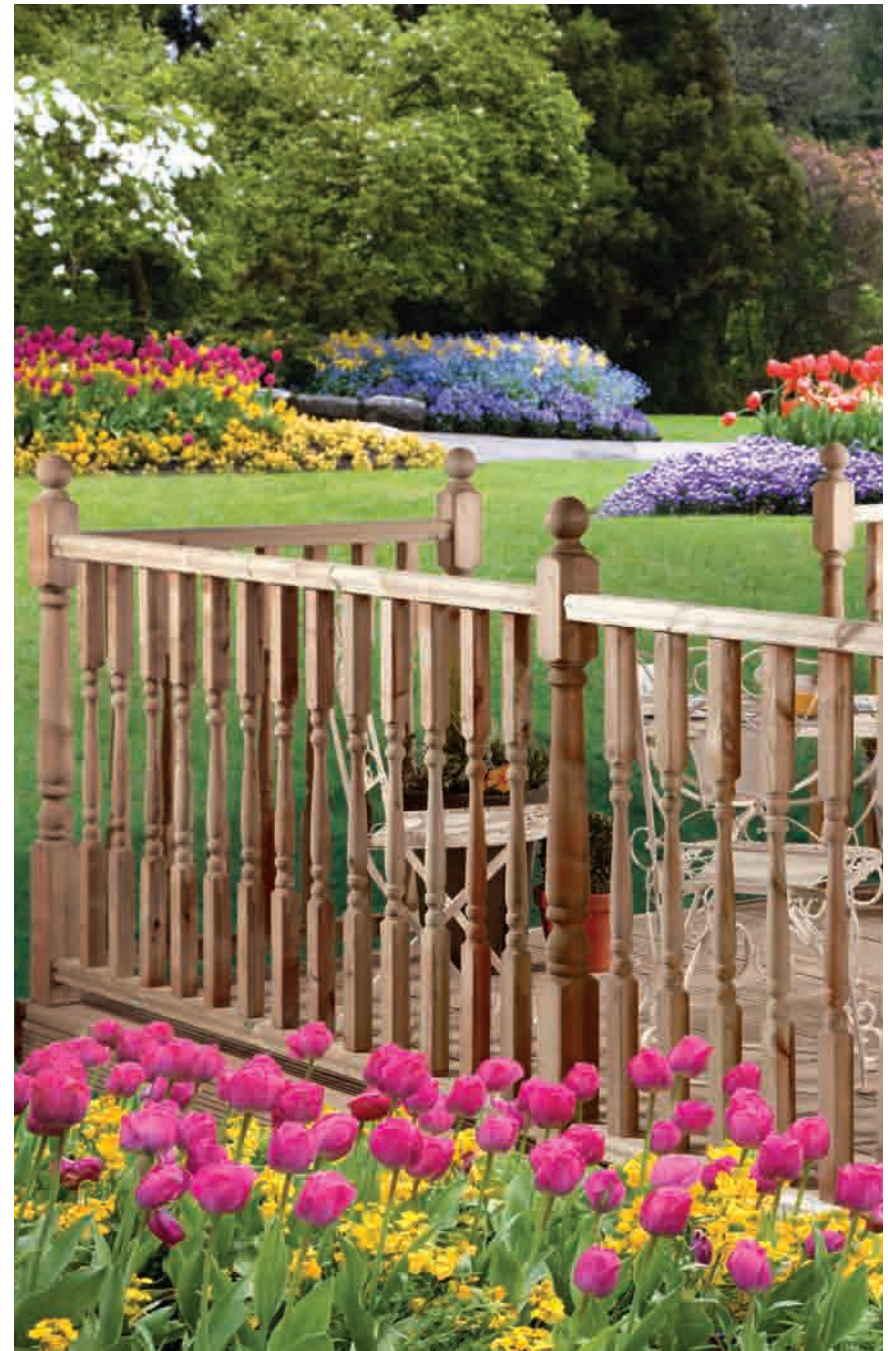



BenchMark

American SOFTWOOD

There's no doubt the design of our American range is engrained with its colonial heritage, but by adding our flat-top universal handrail we've made these decks more practical and a great place to while away the hours.

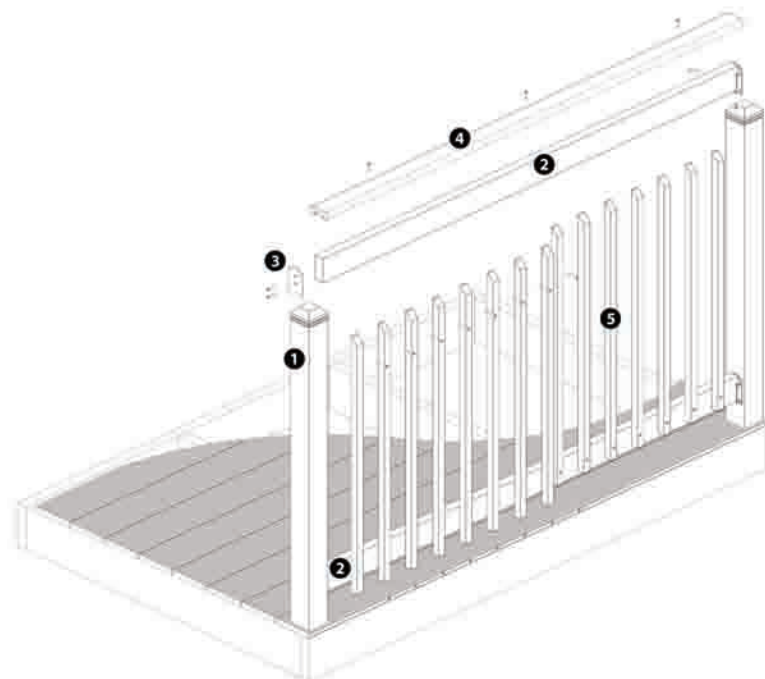

BenchMark		American SOFTWOOD		
Product code	Description	Timber	Pk Qty	
1	DEP12CB/DEP24CB	Benchmark Chamfered & beaded newel	Treated pine	1
2	DCMR	Benchmark Pine rail	Treated pine	1
3	DCVRB	Benchmark Rail fixing brackets	ABS	2
4	DCAP18	Benchmark Capping rail	Treated pine	1
5	DECAM	Benchmark American baluster	Treated pine	1



BenchMark



Roman SOFTWOOD

Cheshire Mouldings' Roman range is a sturdy and reliable balustrade option.

Purposely undersized in height, Roman has been designed to let your garden be the main attraction whilst retaining a solid border to your decking space.

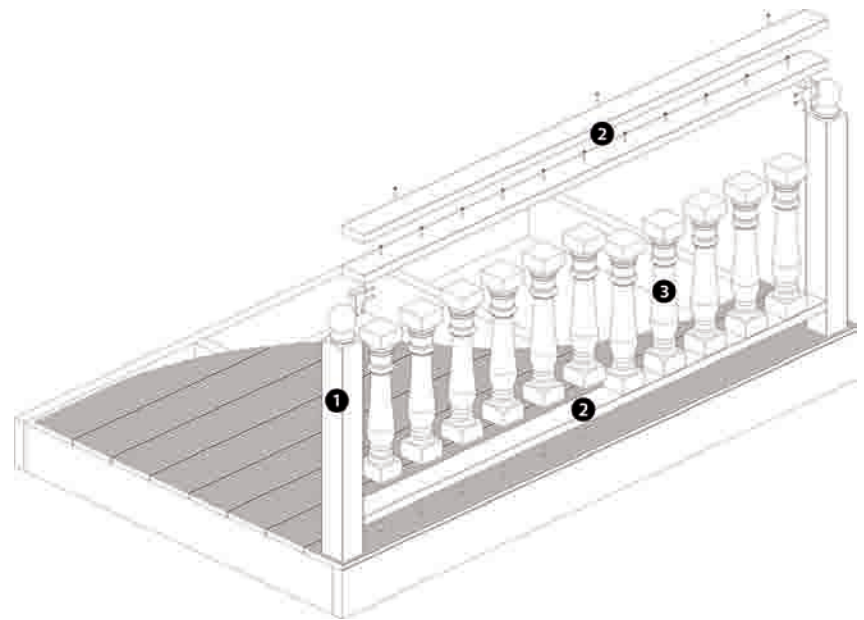

BenchMark Roman SOFTWOOD

Product code	Description	Timber	Pk Qty
1 DEPRC	Benchmark Roman column newel	Treated pine	1
2 DERCR	Benchmark Roman decking rail	Treated pine	1
3 DECROM	Benchmark Roman column	Treated pine	1



The very best protection for your decking timbers

The full range of softwood timbers used for our decking products have been pressure treated within our own facilities with TANALITH E wood preservative. This latest generation, environmentally advanced formulation treatment provides a proven and superior long term protection that will give you real confidence for your decking project. The resulting TANALISED E treated components are fully protected against all forms of wood decay and insect attack, giving a typical service life of 15 years and beyond.

The treated timber is initially pale green in colouration, slowly weathering to a honey brown and eventually to a silver grey. TANALISED E pressure treated timber does not need to be painted or stained to maintain the preservative protection, although a decorative coating can be added, if desired.

What is TANALITH E?

TANALITH E is a unique, highly effective preservative protection system based on patented copper triazole technology, developed by Arch, world leaders in timber protection technology. The copper is derived from recycled sources and is well known for its fungicidal and insecticidal properties. Combining copper with a dual triazole system broadens its spectrum of activity to give complete protection against all wood decay organisms. The triazoles used in TANALITH E are biodegradable and are commonly used to protect many of the food crops we eat.

Proven performance

TANALITH E wood preservative has now been used successfully in the UK for over 12 years and is the premium wood preservative in more than 35 countries worldwide. Not only does it meet the requirements of the industry standard BS8417, but its performance credentials exceed other wood preservatives on the market. TANALITH E has been tested in more than 20 independent field sites around the world under a wide variety of conditions.

Our preservative treatments are strictly controlled by our own fully trained treatment plant operators to ensure the correct level of protection for the timbers.

Working with TANALISED E pressure treated timber

With the preservative fully impregnated into the wood, TANALISED E pressure treated timber is a safe and versatile construction material. The normal precautions that would be used with untreated timber should be employed – a detailed consumer information leaflet is available on request.

If any cutting, notching or drilling is made to the treated timber components, any exposed surfaces must be liberally swabbed with ENSELE end grain preservative to maintain the integrity of the treatment. ENSELE end grain preservative is available through Cheshire Mouldings.

© Ensele, Tanalith and Tanalised are registered trademarks of Arch Timber Protection.



PRESSURE TREATED TIMBER



The Treatment Process

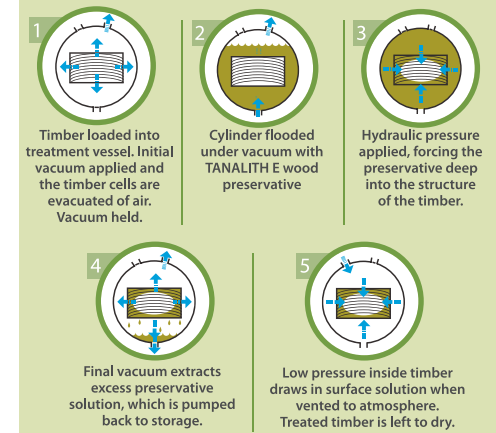



axxys® DEK²

Squared HARDWOOD

We're really excited about **axxys** dek squared and it's a design that's been shaped by modern, urban life.

Quality aluminium components in a choice of finishes keep maintenance to an absolute minimum, while their inherent strength make this range perfect for raised decks and outdoor spaces where the emphasis is on being social and living life to the full.

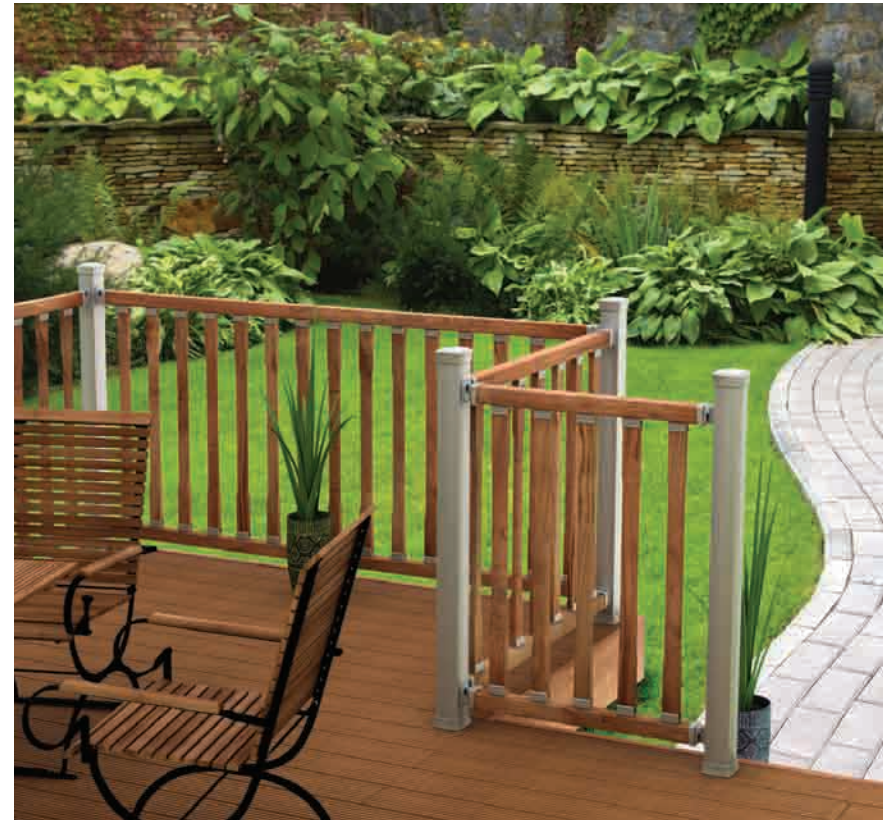
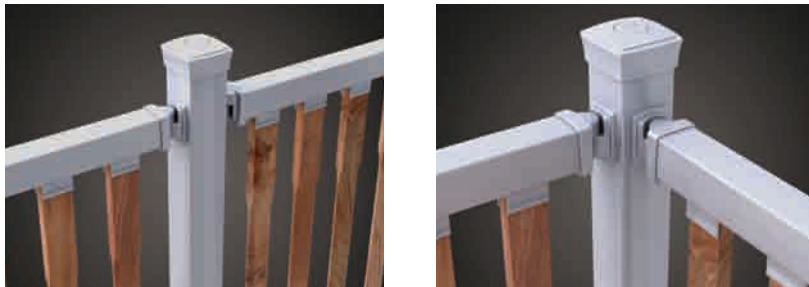

axxys DEK ²		Square HARDWOOD	
Product code	Description	Timber	Pk Qty
1	DAXSQNL-A/DAXSQNL-P axxys DEK² Newel post	Aluminium	1
2	DAXSQUR-A/P/M axxys DEK² Universal rail	Aluminium/Red hardwood	1
3	DAXSQHRB axxys DEK² Handrail brackets	Zamac3	1 Pair
4	DAXSQBRB axxys DEK² Baserail brackets	Zamac3	1 Pair
5	DAXSQCAP axxys DEK² Newel cap	Zamac3	1
6	DAXSQBS axxys DEK² Newel base	Zamac3	1
7	ADSTBM axxys DEK² Stop chamfered baluster	Red hardwood	1
8	ADTBA axxys DEK² baluster bracket	ABS	1 Pair



Decking - Components

Softwood Decking
Hardwood Decking
ClearView Decking
axxys® Dek
axxys® Dek²



Softwood Decking - Components

Timber Product Code Size Qty Pack Qty RRP

Handrails & Baserails

TREATED PINE	DHU18	1800 x 44 x 68	1
TREATED PINE	DHU24	2400 x 44 x 68	1
TREATED PINE	DHNEW1.8	1800 x 29 x 68	1
TREATED PINE	DHNEW24	2400 x 29 x 68	1

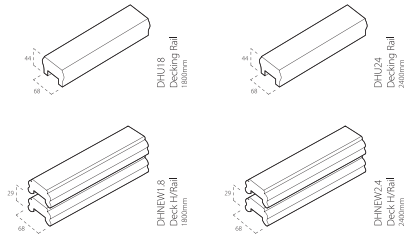

Spindles

TREATED PINE	DED90	895 x 41 x 41	1
TREATED PINE	DEDST9041P	895 x 41 x 41	1
TREATED PINE	DECREED	895 x 41 x 41	1
TREATED PINE	41PBTR	895 x 41 x 41	1

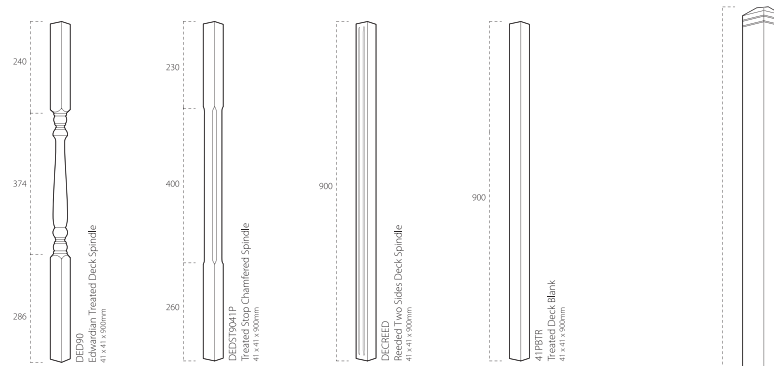

Deck Posts

TREATED PINE	DEP12CAP	1250 x 82 x 82	1
TREATED PINE	DEP12BLANK	1250 x 82 x 82	1
TREATED PINE	DEP12CB	1250 x 82 x 82	1
TREATED PINE	DEP24CB	2400 x 82 x 82	1

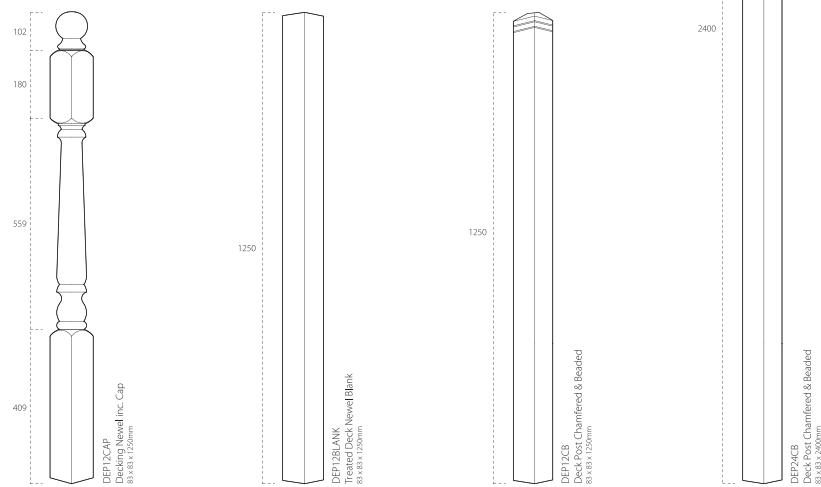

PEFC certified



Softwood Decking - Components

Timber	Product Code	Size	Pack Qty	RRP
--------	--------------	------	----------	-----

Deck Panels

TREATED PINE	DESUN	1130 x 760 x 32	1	
TREATED PINE	DEHAT	1130 x 760 x 32	1	

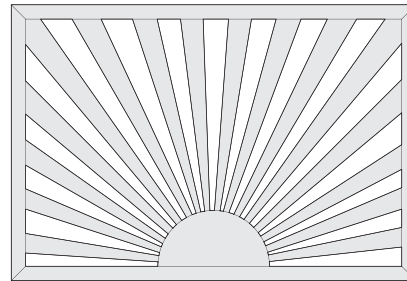

DESUN
Sunburst Decking Panel
1130 x 760 x 32mm

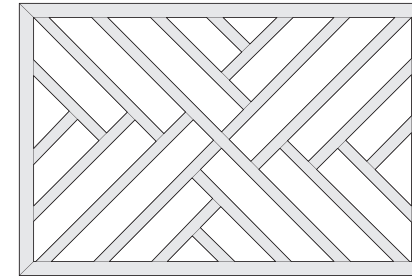

DEHAT
Cross-Hatch Decking Panel
1130 x 760 x 32mm

Roman Range

TREATED PINE	DERCR	1795 x 89 x 28	1	
TREATED PINE	DECROM	83 x 83 x 457	1	
TREATED PINE	DEPRC	91 x 91 x 875	1	

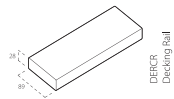

DERCR
Decking Rail
1795 x 89 x 28mm



DECROM
Moulded Roman Column
83 x 83 x 457mm



DEPRC
Column Novelty Inc. Cap
91 x 91 x 875mm

American Range

TREATED PINE	DCMR	1795 x 35 x 88	1	
TREATED PINE	DECAM	27 x 27 x 895	1	

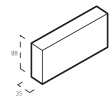

DCMR
Baluster Pine Rail
1795 x 35 x 88mm

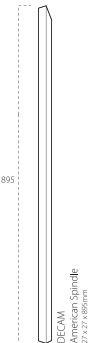

DECAM
Spindle
27 x 27 x 895mm

Caps

TREATED PINE	DEB	132 x 85 x 85	1	
TREATED PINE	DEAC	132 x 84 x 84	1	
TREATED PINE	DEPTC	27 x 115 x 115	1	

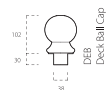

DEB
Deck Ball Cap



DEAC
Deck Acorn Cap



DEPTC
Deck Patire Cap

PEFC certified



Softwood Decking - Components

Timber	Product Code	Size	Pack Qty	RRP
--------	--------------	------	----------	-----

Tread Strings

TREATED PINE	DS3	245 x 868 x 44	1	
TREATED PINE	DS5	245 x 1447 x 44	1	

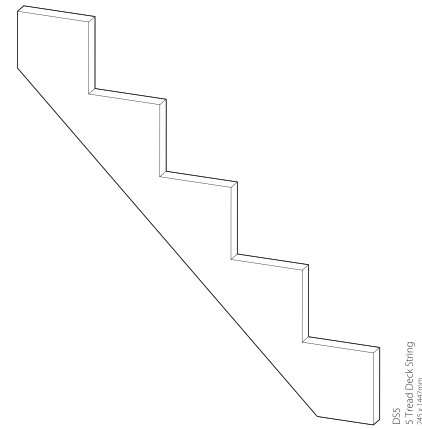
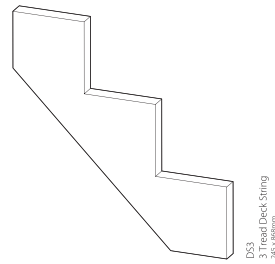

Fixings

ZINC STEEL	DSCREW100	100mm	50	
ZINC STEEL	DSCREW150	150mm	50	
ZINC STEEL	DSCREW40	40mm	150	
ZINC STEEL	DSCREW50	50mm	200	
ZINC STEEL	DSCREW63	60mm	200	
ZINC STEEL	DSCREW75	75mm	200	
ZINC STEEL	DECKIT	N/A	1pr	



Metal Balusters - Aluminium is black powder coated

ALUMINIUM	DEK-EDEN	820 x 26 x 6	5	
ALUMINIUM	DEK-BOW	820 x 26 x 6	5	
TREATED PINE	DCMR	1795 x 35 x 88	1	
ABS	DCVRB	N/A	1pr	

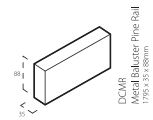
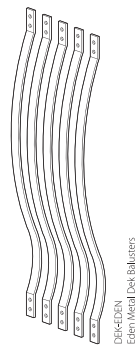
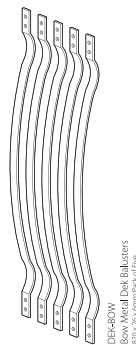

PEFC certified



Hardwood Decking - Components

Timber Product Code Size Pack Qty RRP

Handrails, Baseraills & Capping Rails

REDHARDWOOD DHR1.8M	1800 x 58 x 44	1
REDHARDWOOD DHR1.2M	1200 x 58 x 44	1
REDHARDWOOD DBR1.8M	1800 x 58 x 44	1
REDHARDWOOD DBR1.2M	1200 x 58 x 44	1
REDHARDWOOD DCAP18M	1800 x 71 x 20	1
REDHARDWOOD DCAP12M	1200 x 71 x 20	1

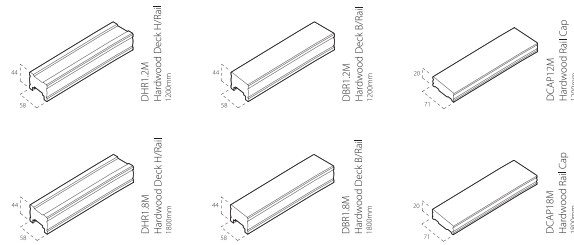

Newels

REDHARDWOOD DEP15CAPM	1500 x 91
REDHARDWOOD DEP15CBM	1500 x 91

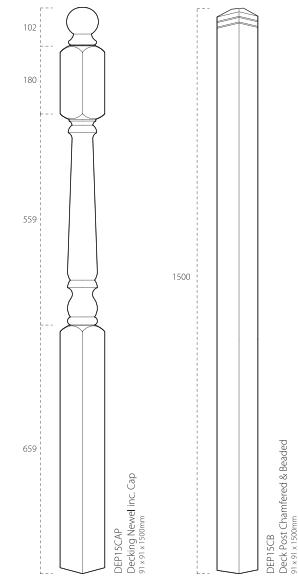

Spindles

REDHARDWOOD DED90M	895 x 41 x 41	1
REDHARDWOOD DED110M	1100 x 41 x 41	1
REDHARDWOOD 41PBTRM	895 x 41 x 41	1
REDHARDWOOD 41PBTR110M	1100 x 41 x 41	1

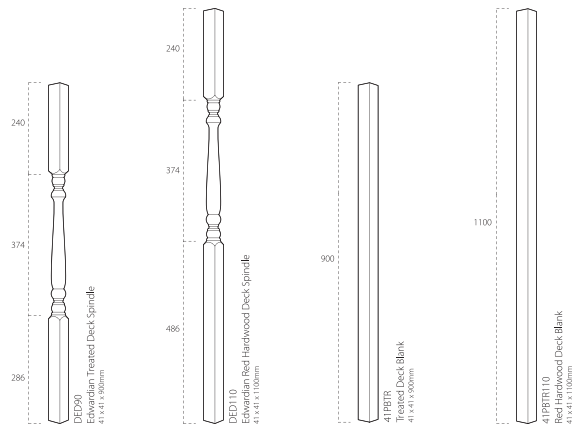

PEFC certified



Clearview & Axxys Dek - Components

Timber Product Code Size Pack Qty RRP

Clearview

TREATED PINE	DCLRAIL	1795 x 28 x 85	1
TREATED PINE	DCAP18	1750 x 80 x 26	1
BLACK	DCVRB	N/A	1pr
GLASS	DCLPAN	8 x 150 x 820	7

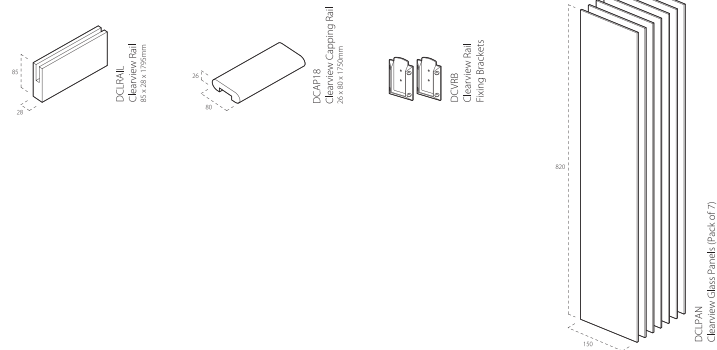

Axxys Dek

TREATED PINE	ADRAIL1.8	1795 x 54 x 54	1
REDHARDWOOD	ADRAIL1.8M	1795 x 54 x 54	1
TREATED PINE	ADNP13	81 x 81 x 1250	1
TREATED PINE	ADNP15	81 x 81 x 1495	1
REDHARDWOOD	ADNP15M	81 x 81 x 1500	1
TREATED PINE	ADSTB	55 x 21 x 887	1
REDHARDWOOD	ADSTBM	55 x 21 x 887	1
TREATED PINE	ADFTB	55 x 21 x 887	1
ALUMINIUM	ADCAPA	100 x 100 x 35	1
BLACK	ADCAPB	100 x 100 x 35	1
ALUMINIUM	ADHRCONA	N/A	1pr
ALUMINIUM	ADBRCONA	N/A	1pr
BLACK	ADHRCONB	N/A	1pr
BLACK	ADBRCONB	N/A	1pr
ALUMINIUM	ADTBA	N/A	1pr
ALUMINIUM	ADTBAB	N/A	10prs
BLACK	ADTBB	N/A	1pr
BLACK	ADTBAB	N/A	10prs

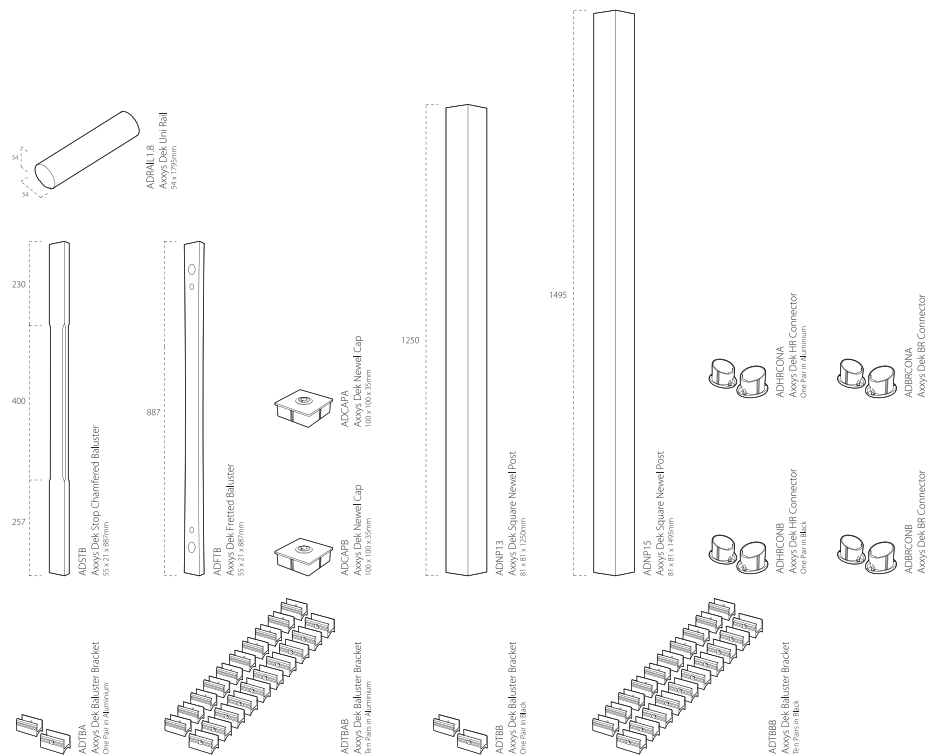

*NOTE FOR STOCKISTS - AXXYS DEK COMPONENTS MUST BE STORED UNDER COVER

PEFC certified



Axxys Dek²

Timber Product Code Size Pack Qty

Universal Rail (Hand & Base)

ALUMINIUM (ANODISED)	DAXSQUR-A	62 x 55 x 2100	1
ALUMINIUM (GREY POWDER COATED)	DAXSQUR-P	62 x 55 x 2100	1
RED HARDWOOD	DAXSQUR-M	62 x 55 x 2100	1

Handrail, Baserail & Spindle Brackets

ALUMINIUM (ANODISED)	DAXSQHRB-A	N/A	1pr
ALUMINIUM (GREY POWDER COATED)	DAXSQHRB-P	N/A	1pr
ALUMINIUM (ANODISED)	DAXSQBRB-A	N/A	1pr
ALUMINIUM (GREY POWDER COATED)	DAXSQBRB-P	N/A	1pr
ALUMINIUM	ADTBA	N/A	1pr

Newel Base, Posts & Caps

ALUMINIUM (ANODISED)	DAXSQBS-A	N/A	1
ALUMINIUM (GREY POWDER COATED)	DAXSQBS-P	N/A	1
ALUMINIUM (ANODISED)	DAXSQNL-A	82 x 82 x 1200	1
ALUMINIUM (GREY POWDER COATED)	DAXSQNL-P	82 x 82 x 1200	1
ALUMINIUM (ANODISED)	DAXSQCAP-A	N/A	1
ALUMINIUM (GREY POWDER COATED)	DAXSQCAP-P	N/A	1

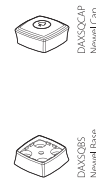
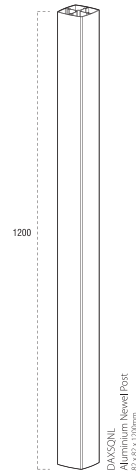
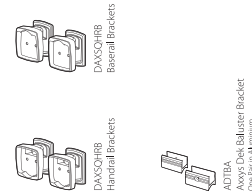
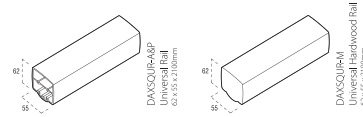

Timber Product Code Size Pack Qty

Spindles

RED HARDWOOD	ADSTBM	55 x 21 x 887	1
--------------	--------	---------------	---

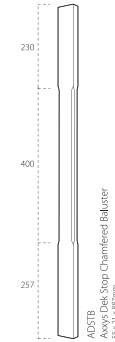

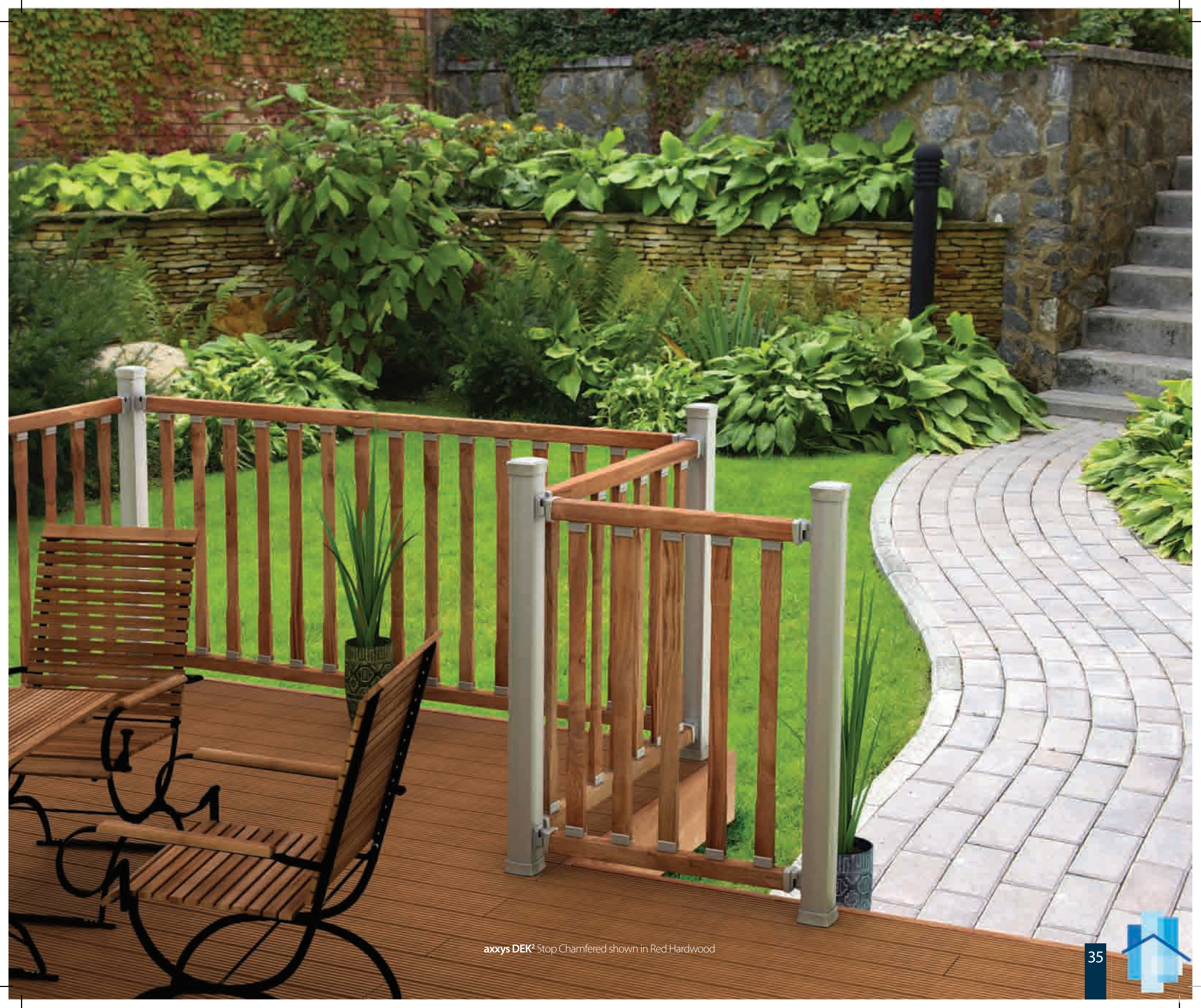

axxys DEK[®] Stop Chamfered shown in Red Hardwood





axxys contemporary stairparts



Benchmark stairparts



Price list



Cheshire Mouldings & Woodturnings Ltd Unit 7, Normans Road, Sutton, St. Helens WA9 4JQ
Telephone +44 (0)1744 811 545 Fax +44(0)1744 811 475 Email enquiries@cheshiremouldings.co.uk
www.cheshiremouldings.co.uk
www.axxys.co.uk

© 2010 Cheshire Moulding & Woodturnings Ltd. For domestic use only. Stairparts have been tested by FIRA to BS6180:1999

