

UDL
up to
500
kg

QUICK
assembly

boltless
system

Expo Shelving

Adaptable Boltless System





“ Expo shelving has been sold
to thousands of customers
for the past 23 years “

Index

- 4 Expo Systems Overview
- 5 Expo 4 | Expo 3 Shelf Overview
- 6 - 7 Loadings & Application
- 8 - 9 Uprights & Frames
- 10 - 11 Shelves, Clips & Shelf Carrier
- 13 Bracing, Wall and Floor Fixing
- 14 - 15 Cladding, Mesh, Louvre, Plinth
- 16 Dividers
- 18 Roll Out Drawer, Binning System
- 19 Shelf Trays, Bins & Spigots
- 20 Cupboard Doors, Filing Frame, Reference Shelf
- 21 Combi Shelf, Lateral Rail, Free Standing Divider
- 22 Tyre Rack, Garment Rail, Vertical Divider Arm
- Two Tier Components
- 23 Components Chart

Expo Overview

EXPO shelving is a market leader for small part and multi-level storage systems. Providing flexible and adaptable solutions to a variety of industries; which offer the customer the potential to maximise their current storage space, whilst meeting the demands of the future.

EXPO shelving has been designed around a single upright profile which enables the system to be completely interchangeable across both shelf designs, all accessories and fittings. Quality is ensured throughout the lifecycle of the product due to the highest levels of design and the latest manufacturing processes used. The ability to meet client's specific demands has meant the system has evolved into offering the broadest range of accessories from one single shelving system.

This means EXPO shelving can be used in a variety of sectors, including Industrial, Retail and Office applications. It has the capability to be built either as just a few simple bays of shelving or a complete self-supporting storage structure, which could be configured as rack supported floors, two or three tier installations or high bay racks which use automated or guided picking equipment.

Compatibility Guide: Expo 3  Expo 4  Both 

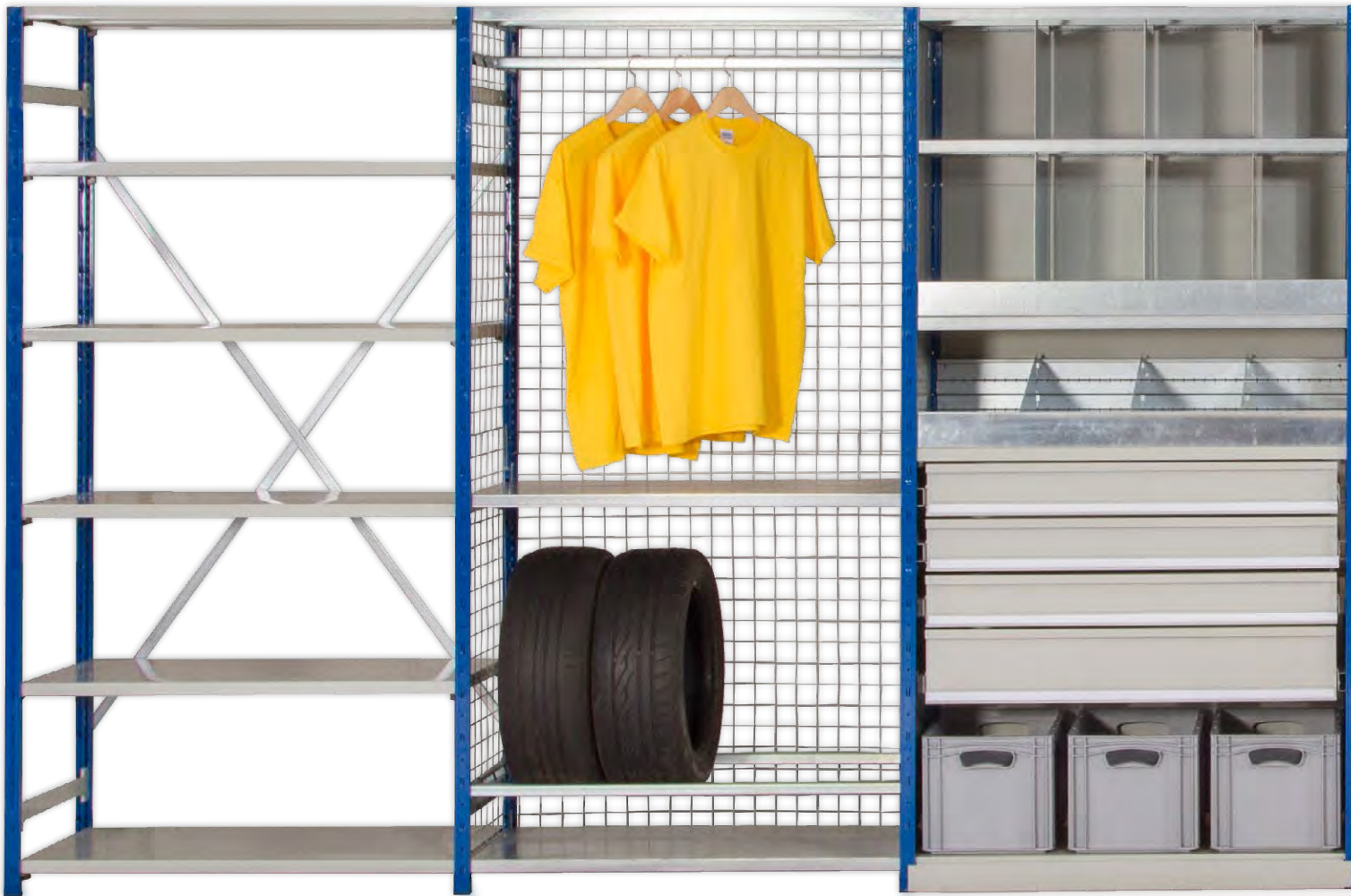

Expo 4 Shelf Overview ⁴

The EXPO 4 shelf design comprises a single shelf panel that sits on a steel clip in each corner. This allows quick and simple installation and adjustment of each level.

Using the latest design and manufacturing technologies the shelf has been designed to provide a "friction fit" due to the unique connection between the shelf, shelf clip and upright. This provides additional strength and stability to the shelf and the bay through its unique design.

The shelves are available in a variety of modular sizes and can also be fitted with either one or two reinforcing ribs depending on the shelf capacity required. The shelves are finished in a hard wearing epoxy powder paint finish.

Expo 3 Shelf Overview ³

The unique design of the EXPO 3 style shelf brings the possibility for a greater range of shelf sizes and capacities. The use of a shelf carrier at each end of the shelf, which supports a combination of shelf panels in a variety of depths, provides capacities up to 500kgs UDL.

This also means the shelf is available in widths from 550 to 1500mm and depths from 200 to 1000mm. The Expo 3 shelf design can also create compartment shelving with the addition of a slotted panel and a fixed height divider. As there is no additional bracing to the end frames, each bay can offer open access on all four sides.



Loadings

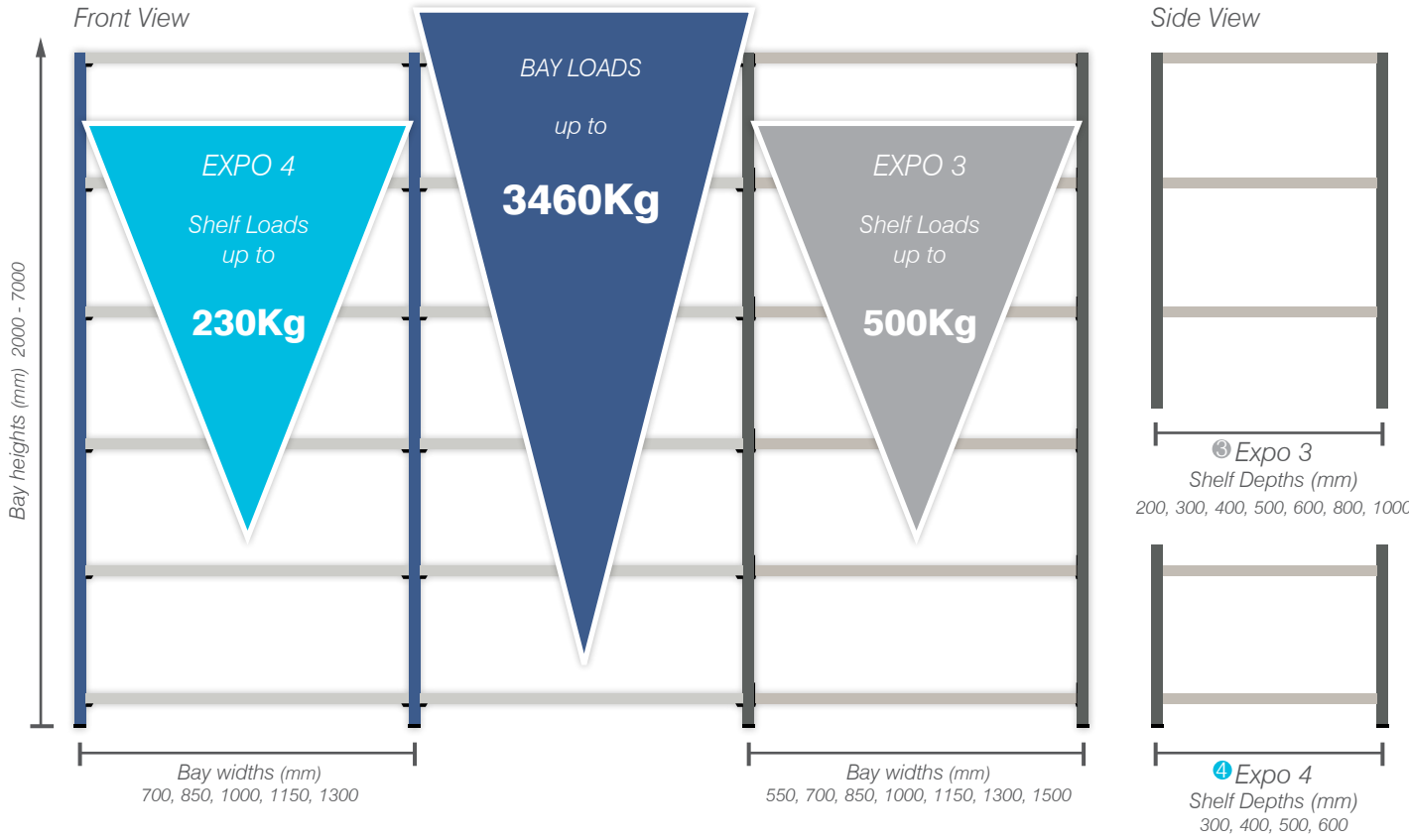

Small Parts Shelving



Industrial Solution

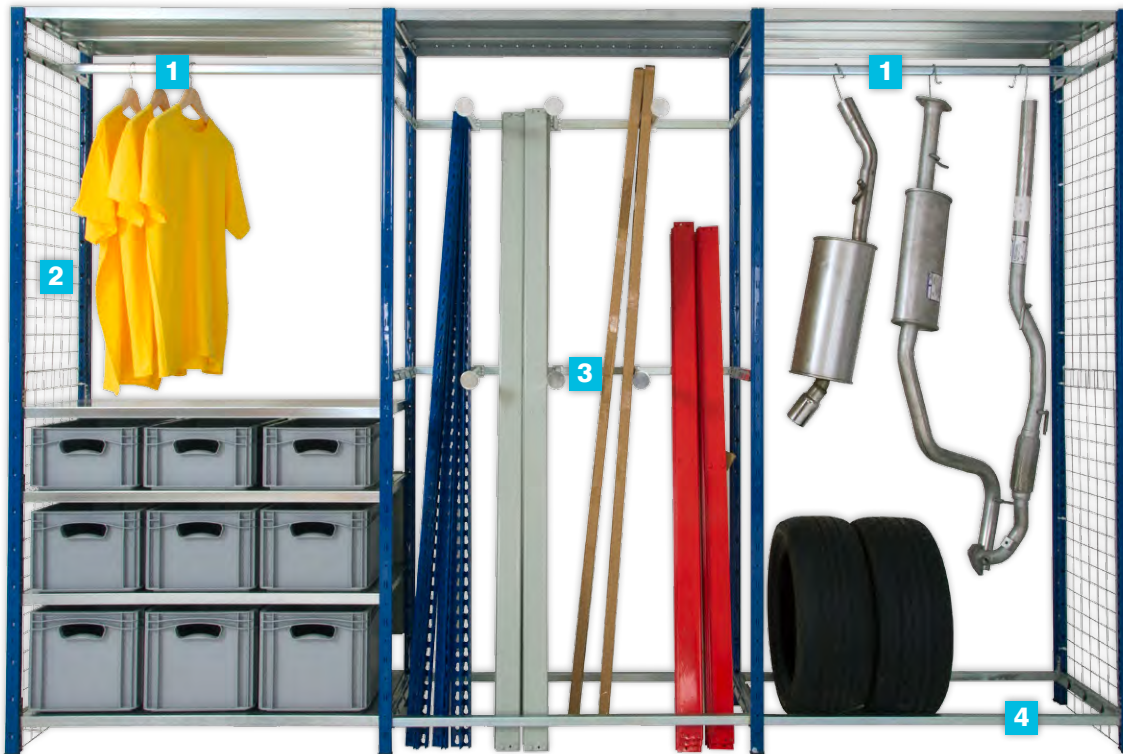

1. Garment / Hanging Rail
2. Mesh Side Panel
3. Vertical Dividers
4. Tyre Rack

Office Solution



1. Hinged Cupboard Door
2. Combination Shelf
3. Roll Out Reference Shelf
4. Roll Out Filing Frame
5. Plinth
6. Free Standing Divider
7. Side Cladding

Uprights ³⁴

The unique cold rolled "T section" upright provides incredible strength and versatility and allows both shelf designs to be totally interchangeable. It can be manufactured in 1.0, 1.2 and 1.5 mm thick steel and in lengths from 2000mm – 7000mm, offering bay capacities up to 3500kgs. The upright can be made in pre-galvanised steel or painted with epoxy powder for a hard wearing and clean finish.

Galvanised

Powder Coated



Dimensions

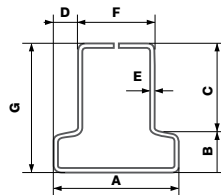
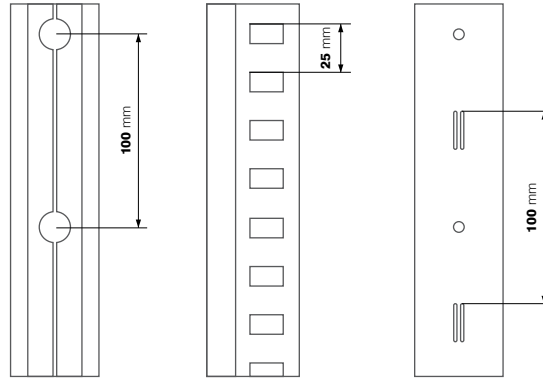

A	B	C	D	E	F	G	
36	11	26	7	1.0	22	37	▲
36	11	26	7	1.2	22	37	●
36	11	26	7	1.5	22	37	■

Bay Loadings / kgs

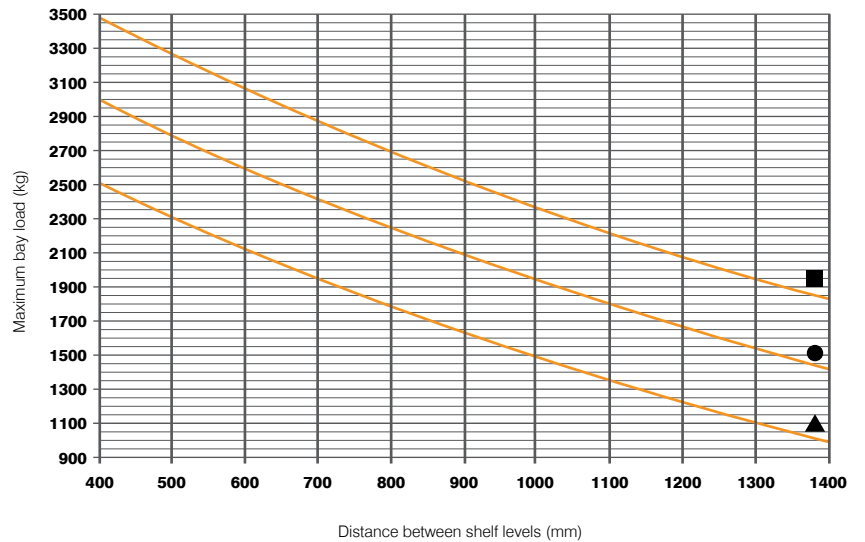

Feet ³⁴

Metal Foot/Upright

Metal Foot

Plastic Foot



The system comes supplied with a plastic foot which stops the upright marking floors. The metal foot allows the system to be secured to the floor for increased stability when bays are above the recommended height to depth ratio.



Side Frame Assembly – EXPO 4 only

Below is the recommended position of horizontal side battens for Expo 4 side frames. They simply tap in to the uprights at the locations indicated and held in place via a safety tongue which eliminates accidental removal. Frames are available from 2000mm to 7000mm and 300, 400, 500 and 600mm deep.

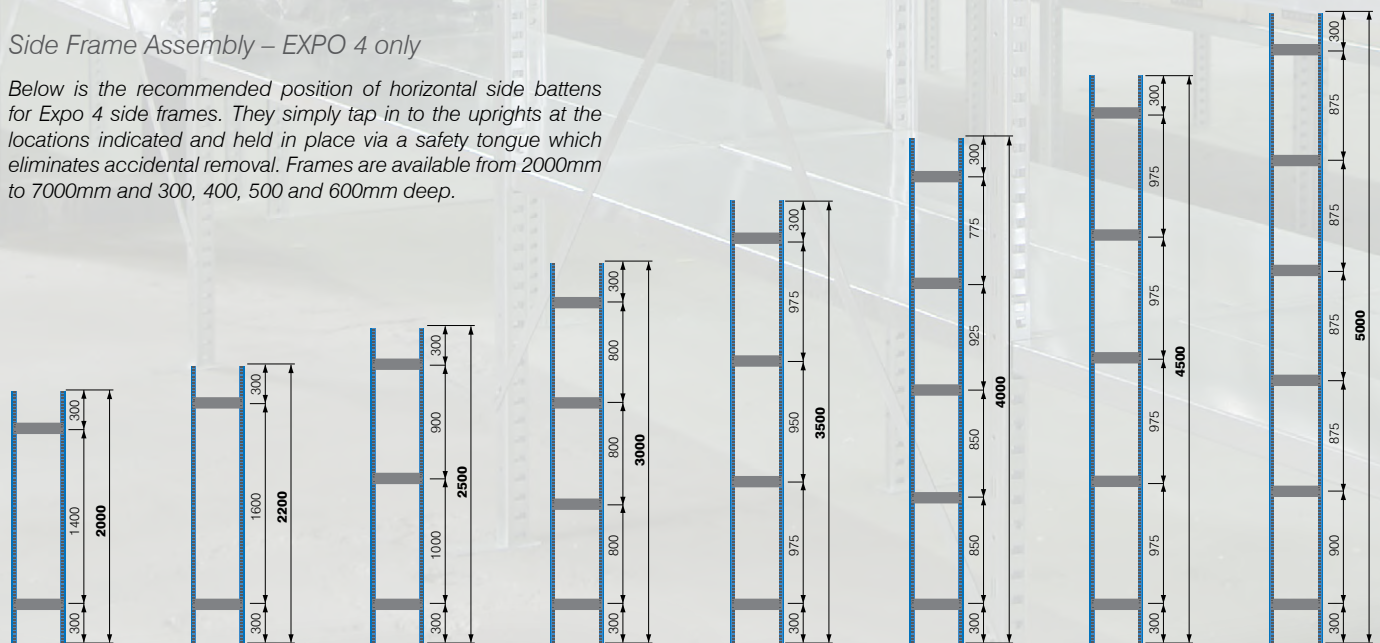

Expo 4 Shelving

Expo 4 Shelf

Available in widths 700, 850, 1000, 1150 and 1300mm wide and 300, 400, 500 and 600mm deep. The shelves come supplied in a variety of capacities and when a single or double reinforcing rib is added capacities of 210kgs can be achieved. The shelf is 30mm thick and sits on a steel clip in each corner, the shelf can be adjusted on a pitch of 25mm.

Expo 4 Shelf - Heavy Duty



Expo 4 shelf design fitted with additional reinforcing ribs to provide additional strength and load bearing capacity.

Expo 4 Shelf - Standard Duty



Standard Expo 4 shelf design with no additional reinforcing ribs, the 400mm deep is designed to be used as a combination shelf where 330mm laterals files can be hung underneath.

Expo 4 Shelf Clip



U shape steel clip, which slots into the upright at 25mm increments. The unique shape engages into the underneath of the shelf providing a "friction fit" which offers greater strength and stability to the shelf and bay.

Horizontal Side Batten



Horizontal side battens are used to build the Expo 4 side frames. They simply tap in to the uprights and held in place via a safety tongue which eliminates accidental removal. Available 300, 400, 500 and 600mm and finished in a hard wearing epoxy powder finish.

EXPO 4 Shelf

Maximum Uniformly Distributed Load (UDL/Kg)

Width (mm)	Length (mm)		
	700	1000	1150
300	140	110	90
400	130	110	90
400 R	220	200	180
500 R	200	180	150
600 R	180	-	-
600 RR	230	200	150

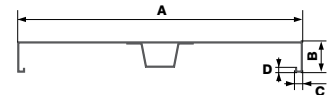
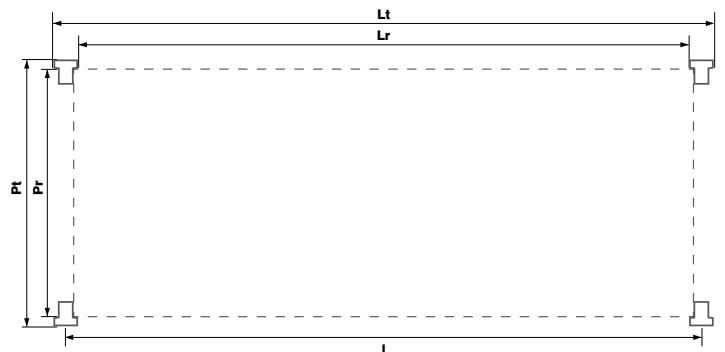

Image: Shelf with Single Reinforcing Rib

A	B	C	D
300	30	36	10
400	30	36	10
500	30	36	10
600	30	36	10

R - Single Reinforcing Rib
RR - Two Reinforcing Ribs



Description	Code	Expo 3 Shelf	Expo 4 Shelf
Nominal Length	Ln	List Measurement	List Measurement
Real Length	Lr	$Lr = Ln - 20 \text{ mm}$	$Lr = Ln - 14 \text{ mm}$
Total Length	Lt	$Lt = l + 36 \text{ mm}$	$Lt = l + 36 \text{ mm}$
Centre Distance	l	$l = Ln + 6 \text{ mm}$	$l = Ln + 6 \text{ mm}$
Nominal Depth	Pn	List Measurement	List Measurement
Real Depth	Pr	$Pr = Pn$	$Pr = Pn$
Total Depth	Pt	$Pt = Pn + 20 \text{ mm}$	$Pt = Pn + 20 \text{ mm}$

Expo 3 Shelf

EXPO 3 shelf panels can be manufactured in lengths from 550 to 1500 mm long and two thicknesses of steel, depending on the load requirements. The panels are made 100, 200, 300 and 400mm deep and are used in combinations to make up the overall depth of the bay. This means the design of each shelf can match each customer's requirements in terms of both loadings and costs. All shelves are manufactured in pre-galvanised steel.

Shelf Panel (200mm wide) ③

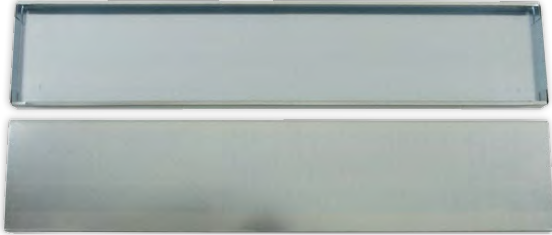

Shelf Panel (100mm wide) ③



Maximum Load Bearing Capacity (kg UDL) 0.6 mm steel

Width (mm)	Length (mm)					
	550	700	850	1000	1150	1300
100	100	100	80	70	60	50
200	100	100	80	70	60	50
300	100	100	80	70	60	50

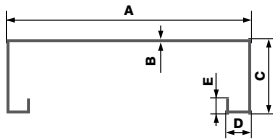

A	B	C	D	E
100	0.6	30	10	6
200	0.6	30	10	6
300	0.6	30	10	6

Maximum Load Bearing Capacity (kg UDL) 0.8 mm steel

Width (mm)	Length (mm)						
	550	700	850	1000	1150	1300	1500
100	140	120	110	100	90	70	50
200	140	120	110	100	90	70	50
300	120	110	100	90	70	50	-
400	120	110	100	90	70	50	-

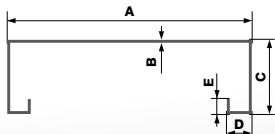

A	B	C	D	E
100	0.8	30	10	6
200	0.8	30	10	6
300	0.8	30	10	6
400	0.8	30	10	6

Shelf Carrier ③ (single (top), double (bottom))

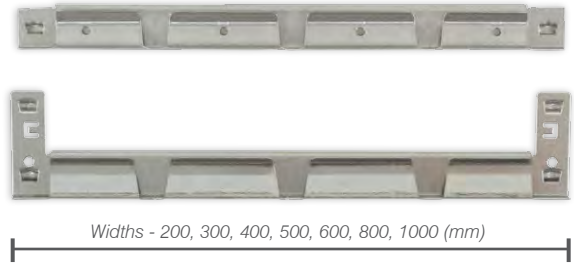

The EXPO 3 shelf carrier comes in either a single tongue or double tongue connector. The single carrier is used at the top of each bay to provide a flush finish, whilst the double carrier is used on all other levels. The double carrier also provides the bracing for each side frame, in turn provides uninterrupted access to each frame.

The carrier design offers full support across the depth of the shelf and by adding multiple shelf panels, increases the load bearing capacity up to 500kgs. Shelf carriers are available in pre-galvanised steel and can be made from 200 – 1000mm deep.

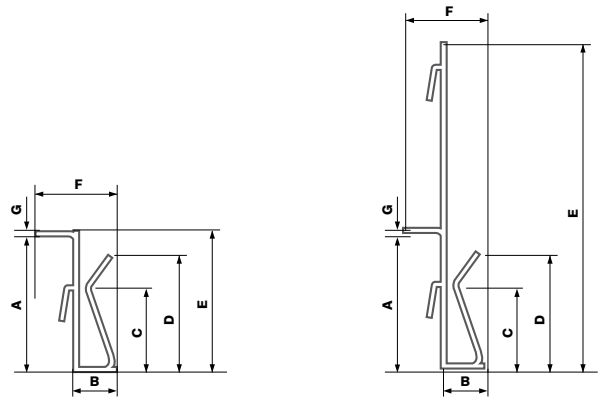

Single Small Beam

A	B	C	D	E	F	G
30	10	19	27	32	20	1.2

Double Small Beam

A	B	C	D	E	F	G
30	10	19	27	75	20	1.2



④ EXPO 4 shelf on shelf clips



③ EXPO 3 shelf on shelf carrier



Bracing the Bays



Application of Cross Bracing on a run of bays

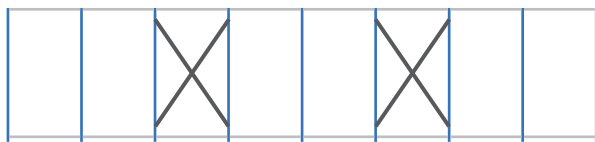

One cross brace every four bays

Horizontal Back Brace ③④

The Horizontal Back Brace is bolted to the front and rear of every second bay within the run. They are fixed at the same level as a shelf which also means the bay has access from both sides.



Back Cross Brace ③④

The simple Cross Brace is bolted to the back of the shelving bay. The rolled strips are held securely with nuts and bolts and are slotted to provide adjustment when leveling. One Cross Brace is fitted every four bays within the run.



Application of Horizontal Bracing on a run of bays

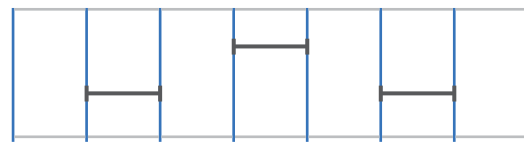

Two horizontal braces every two bays

Wall Tie Bracket ③④



The Wall Tie Bracket simply slots into the top of the EXPO upright and is then secured to the wall. The bracket is cranked to allow the shelving to be set slightly forward to avoid any small obstructions on the wall.

Metal Foot ③④



The metal foot allows the system to be secured to the floor for increased stability when bays are above the recommended height to depth ratio.

Cladding Options

Back Cladding

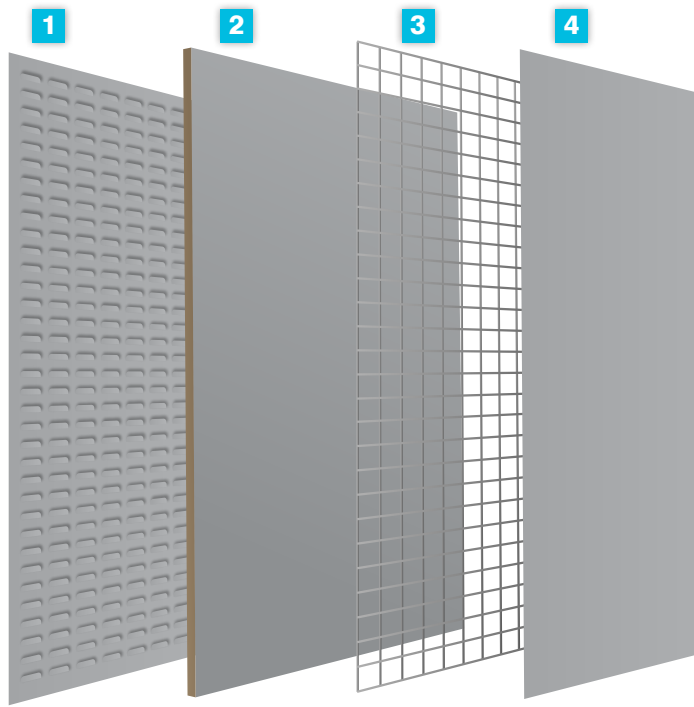

Side Cladding

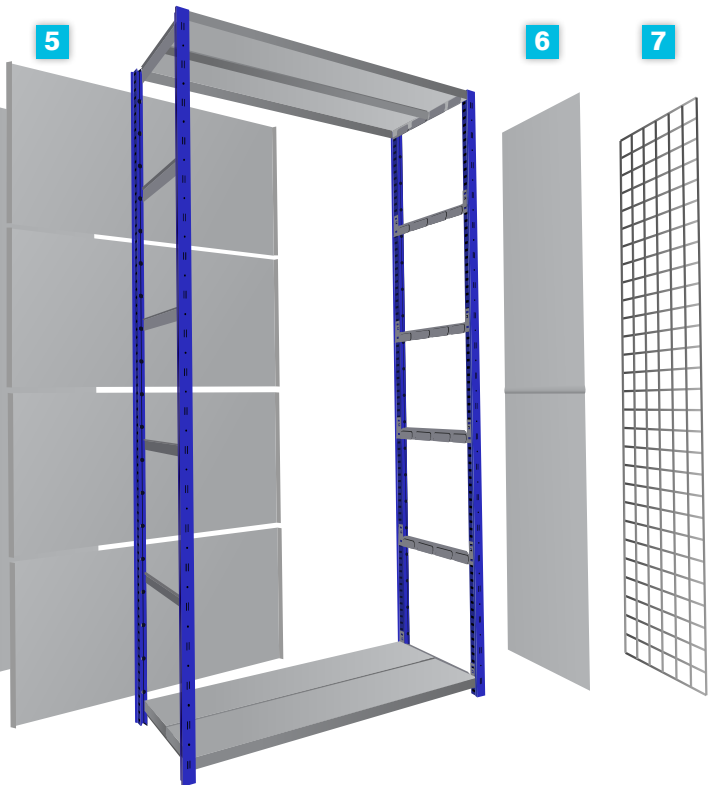

The EXPO system can have a variety of side and back cladding, simply and quickly fitted to the bays. Whether the system needs to be solid or mesh clad, MDF or steel, there is a solution to meet any requirement. The use of louvre panels extends the flexibility of the system still further.

1 Louvre Back Panel ③④

To create picking areas at the back and front of the bay, can be fitted with plastic storage bins or steel spigots and hooks.

2 MDF Board ③④

MDF board with a light grey foil, provides a secure, cost effective back panel.

3 Mesh Back Panel ③④

Light yet incredibly strong and secure welded mesh wire panels also provide light and ventilation around the stored product

4 Steel Back Cladding ③④

Steel side cladding that is positioned between back to back runs of shelving. (Note : not suitable for single sided runs)

5 Hook-In Back Panel ③④

Steel panels that simply hook into the back of the uprights, hooks directly into the slots on the face of the upright. First panel must be installed 100mm from the floor - suitable for single and double sided runs of shelving

6 Steel Side Cladding ③④

Steel side cladding that simply and securely slides into the frame with no fixings. Each side frame is supplied in sections to suit the different heights with each section connected by a plastic joining rib.

7 Mesh Side Panel (EXPO 4 only) ④

Light yet incredibly strong and secure welded mesh wire panels also provide light and ventilation around the stored product. (Note : only compatible with EXPO 4 side frames)

Plinth ③④



Simple clip in steel plinth that eliminates dust and debris getting under the bottom shelf.



Hook-In Back Cladding 34

How to connect back panels



Hook In Steel Back panels that simply clip into the slots on the face of the upright. Panels are available in all bay widths and come in 400 and 500mm sections. The first panel is positioned 100mm from the floor, then a combination of the two heights are used to clad the entire height of the bay. (Note: suitable for single and double sided runs of shelving).

Mesh Panel

Mesh Side Panel 4

Mesh Back Panel 34

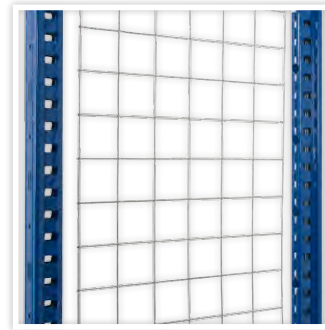

2 x 2" pre-welded galvanized mesh



Light yet incredibly strong and secure, welded mesh wire panels also provide light and ventilation around the stored product.

Side Cladding 34

Joining Rib Detail



Steel side cladding that simply and securely slides into the frame with no fixings. Each side frame is supplied in sections to suit the overall height of the frame, each section is connected by a plastic joining rib.



Louvre Panel 34

Galvanised Steel Louvre Panels

Louvre Panels create picking areas at the back and front of the shelving, designed to fit the 1000mm wide bays. The panels can then have semi-open fronted plastic storage bins or retail style display spigots and hooks attached.



Expo Compartment Shelving

Fixed Height Dividers

Compartment shelving is suitable for sub-dividing shelves to keep items organized and in their own location. By using a specially slotted EXPO3 Shelf panel and a vertical steel divider, multiple compartments can be created within each shelf.

The dividers can be positioned every 50mm along the shelf and made any height in increments of 25mm. The addition of a bin front and back panel means smaller items can also be stored.

Bin Front Detail

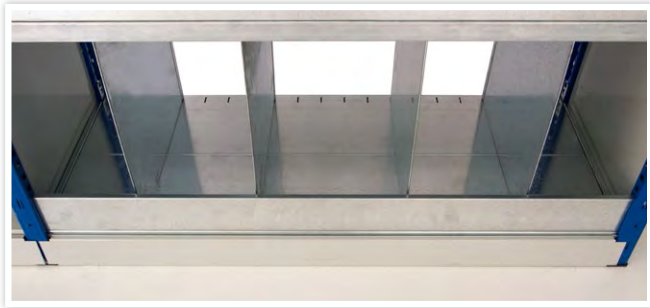

Slotted Shelf

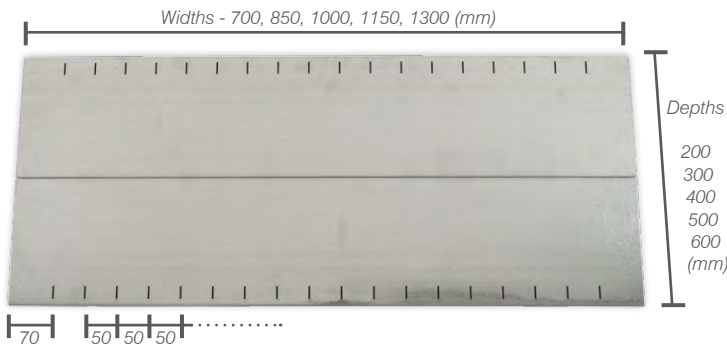

Fixed Divider

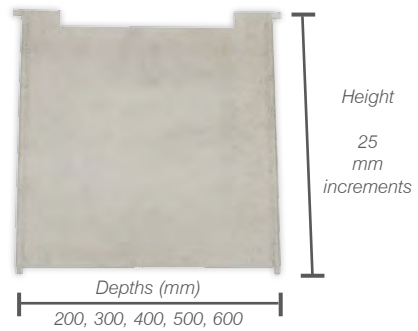

Free Standing Divider



A simple divider that clips on to the shelf and then moved along the entire shelf to exact position required. The standard divider stands 200mm high; other sizes can be manufactured to order.

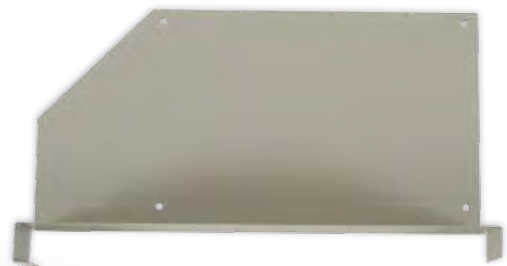



Roll Out Compartment Drawer ③④

Compartment drawer mounted on telescopic slides



Roll Out Compartment drawers are suitable for high density storage of small parts and components. The drawers can be sub divided front to back and then a cross divider can be added to further create smaller compartments within the drawer. The drawers are available 1000mm wide and in two heights – 120 and 170mm.



Drawer Dividers

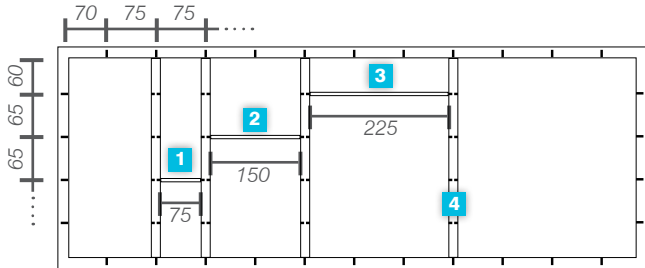

1 2 3 side to side dividers
75, 150, 225 mm
4 front to back dividers
400, 500, 600 mm

Binning System ③④

Adjustable divider based picking system

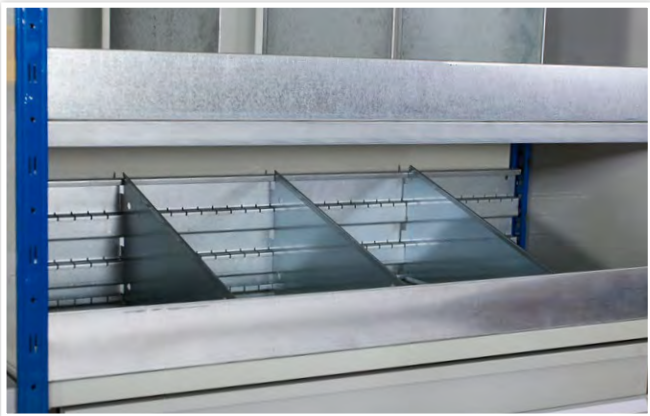

The shelf mounted adjustable binning system is ideal for retrieval of loose components. The dividers can be adjusted every 20mm allowing for multiple picking locations as well as the location size being adjusted to suit changes in stock levels.

Parts



Back wall, front wall and divider

Shelf Trays 4

The Heavy Duty Shelf Trays have been designed specifically to fit the EXPO 4 shelving and maximise the density of storing small parts within small part shelving bays.

Each tray fits perfectly within the 1000mm wide modules and is available in two widths, two heights and three depths, all of which can be sub divided by a simple slot in divider.

The trays and dividers have a large reference label for clear identification which means selecting the correct item is much easier. The addition of the sprung loaded shelf stop allows the tray to be safely withdrawn and held in position without the risk of the tray falling.

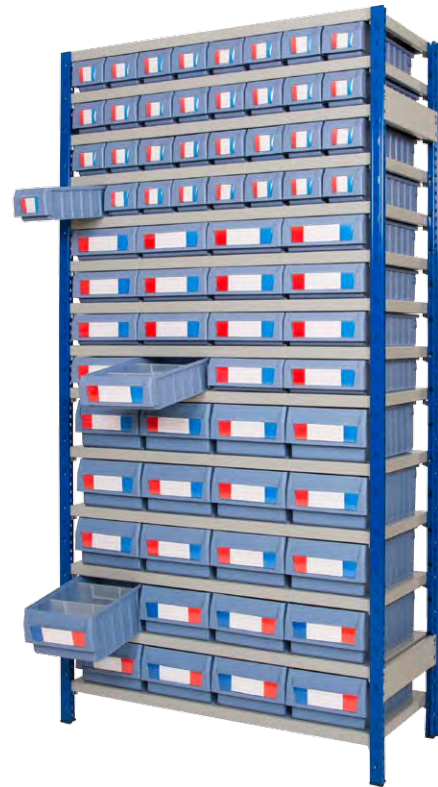

Display Spigots 34

A selection of Display Spigots for retail storage and display, all finished in epoxy powder paint and designed to be hung on our standard louvre panels.

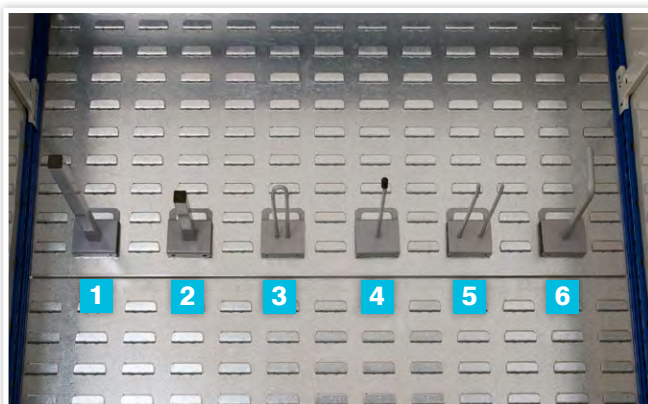

1	Square tube spigot	300mm
2	Square tube spigot	150mm
3	Euro hook spigot	200mm
4	Single prong spigot	200mm
5	Double prong spigot	200mm
6	Steel hook spigot	200mm

Louvre Plastic Bins 34

Rhino Tuff plastic storage bins that are available in red, blue and yellow as well as a recycled light grey and 8 sizes. All sizes can be hung on louvre panels and come with a lifetime guarantee.

	Code	Size (W x D x H)
1	ARTB05	106x106x49
2	ARTB10	106x136x76
3	ARTB20	106x187x76
4	ARTB25	140x205x127
5	ARTB30	140x274x127
6	ARTB40	210x375x179
7	ARTB50	280x457x254
8	ARTB60	415x375x179

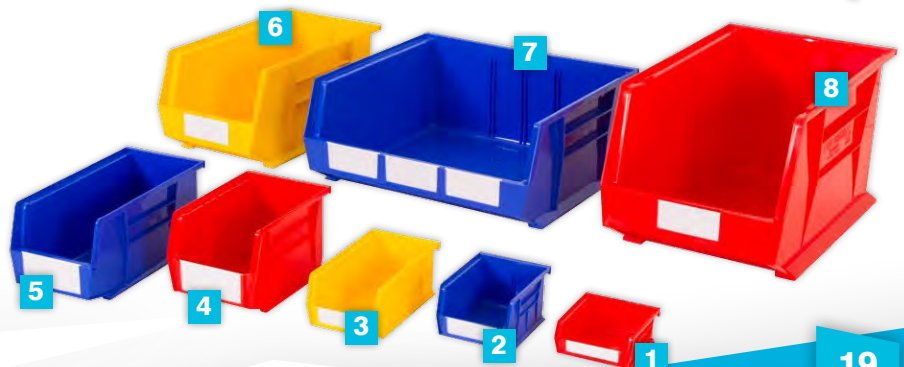

Cupboard Doors 34

Sliding Doors



Hinged Doors



Sliding Doors

Modular double sliding door 2000mm wide x 2000mm high, which comes as a two part kit assembled on site and then attached to the front of the shelving. All finished in epoxy powder paint and comes with a cylinder lock and two keys.

Hinged Doors

Modular double hinged door 1000mm wide x 2000mm high, the doors pre-hung within a fully welded frame, which is then attached to the front of the bay. All finished in epoxy powder paint and comes with a cylinder lock and two keys.

Roll Out Filing Frame 34

Filing frame mounted on telescopic runners



Roll Out Filing Frames that are designed to hold all leading sizes of suspension files. The frame is designed to hold A4 files across the cradle or Foolscap files can be accommodated in two rows, front to back with the addition of two filing bars.



Roll Out Reference Shelf 34

Roll Out Reference Shelf provides a useable shelf that can be extended from the shelving, ideal when working or retrieving documents from the bay itself. Designed to suit the 1000mm wide bays and comes finished in epoxy powder paint.



Combi Shelf ⁴

Combi Shelf with files



Combi Shelf detail



The Combination Shelf is a 1000 x 400mm shelf, without a reinforcing rib. This means standard 330mm lateral files can be suspended underneath the shelf as well as using it as a normal storage level. The shelf has the capacity to hold 0.95 l/m of lateral filing.

Lateral Rail ³⁴

Lateral Rail with Files



Lateral Rail detail



The adjustable rails fit into a standard EXPO 3 shelf carrier enabling them to be adjusted to suit various sizes of lateral files, including the most popular 330mm and 276mm files.

Free Standing Divider ³⁴

Free Standing Divider Detail

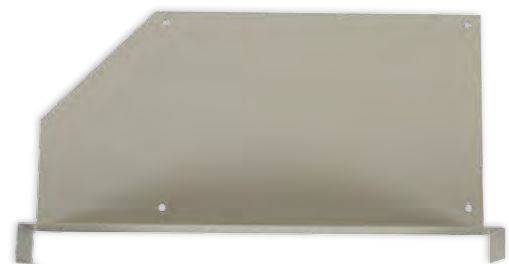

A simple Free Standing Divider that clips on to the shelf and then can be moved along the shelf to exact position required. The standard divider stands 200mm, other sizes can be manufactured to order.

Tyre Rack

Square Tube Rails for Tyres



Two square tube rails that fit into a standard EXPO 3 shelf carrier, which can be used for storing tyres and alloy wheels etc.

Garment Rail

Fitted Garment Rail



An oval tube garment rail that fits into a standard EXPO 3 shelf carrier, will sit centrally in 400 and 600mm carriers.

Vertical Divider Arm

Dividers for Long items



Clip on divider arm that creates compartments for vertical storage, it is simply slid into the required position. The arms are used with the square tube rails and EXPO 3 carriers.

Two Tier Components

Upright Splice



Internal splice used to join two uprights together so the height of the bay can be increased. It has been designed as an internal connection, so shelves and accessories can be used at the connection point.

Floor Support Brackets

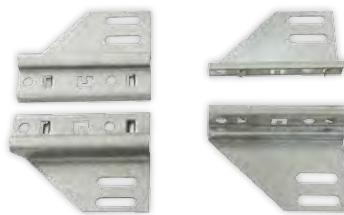

Clip in brackets that are used to support the floor construction used in multi-tier and rack supported floors. Available in 4 styles, LH and RH inline and cross aisle brackets, which allow Floor Angle to be bolted to the face, this then supports either chipboard or steel flooring panels.

Floor Angle



Two sizes of angle that can be supplied in a variety of lengths that are bolted to the floor support brackets.



Expo Components

Compatibility & Sizes Chart

Component	System	Page	Depths (mm)								Widths (mm)						
			100	200	300	400	500	600	800	1000	550	700	850	1000	1150	1300	1150
Upright	③ ④	06															
Plastic Foot	③ ④	06															
Metal Foot	③ ④	06															
Metal Shim	③ ④	--															
Horizontal Side Batton	④	10			●	●	●	●									
Expo 4 Shelf	④	10				●	●	●					●	●	●	●	
Expo 4 R Shelf	④	10							●				●	●	●	●	
Expo 4 RR Shelf	④	10											●	●	●	●	
Expo 4 Shelf Clip	④	10															
Back Cross Brace	③ ④	13											●	●	●	●	●
Wall tie Bracket	③ ④	13															
Horizontal Back Brace	③ ④	13										●	●	●	●	●	●
Single Shelf Carrier	③	11		●	●	●	●	●	●	●							
Double Shelf Carrier	③	11		●	●	●	●	●	●	●							
Expo 3 Shelf Panel	③	11	●	●	●	●						●	●	●	●	●	●
Solid Side Clad	③ ④	15			●	●	●	●									
Mesh Side Panel	④	15			●	●	●	●									
Mesh Back Panel	③ ④	15											●	●			
Solid Back Cladding	③ ④	15												●			
Hook-In Back Panel	③ ④	15										●	●	●	●	●	
MDF Back Panel	③ ④	15											●	●			
Louvre Back Panel	③ ④	15												●			
Plinth	③ ④	14											●	●			
Expo 3 Slotted Shelf	③	16	●	●	●	●							●	●	●	●	
Expo 3 Fixed Divider	③	16			●	●	●	●									
Free Standing Divider	③ ④	16			●	●	●	●									
Roll Out Drawer H120	③ ④	18				●	●	●						●			
Roll Out Drawer H170	③ ④	18				●	●	●						●			
Binning System	③ ④	18			●	●	●	●				●	●	●	●	●	●
Plastic Shelf Tray	④	19			●	●	●							●			
Louvre Plastic Bins	③ ④	19															
Display Spigots	③ ④	19															
Sliding Cupboard Doors	③ ④	20													*		
Hinged Cupboard Doors	③ ④	20													●		
Roll Out Filing Frame	③ ④	20				●									●		
Roll Out Reference Shelf	③ ④	20				●									●		
Combi-Shelf	④	21				●									●		
Lateral Filing Rail	③ ④	21				●									●		
Tyre Rack	③	22				●	●	●							●		
Garment Rail	③	22										●	●	●	●	●	●
Vertical Divider Arm	③	22															
Upright Splice	③ ④	22															
Floor Support Bracket	③ ④	22															
Floor Angle	③ ④	22															

④ EXPO 4 system

③ EXPO 3 system

● Size Availability

■ Size Independent Components

* 2000mm wide door frame fits two 1000mm bays

