

S
Y
S
T
E
M
S



Product Catalog



CHICK
Efficiency Through Workholding Innovation

5



Part Change Efficiency

5



Set Up Efficiency

5



Tool Change Efficiency

5



Ease Of Use Efficiency

5

WHAT IS CHICK WORKHOLDING? Efficiency Through Workholding Innovation.

WORKHOLDING DESIGNED FOR YOUR MACHINING CENTER

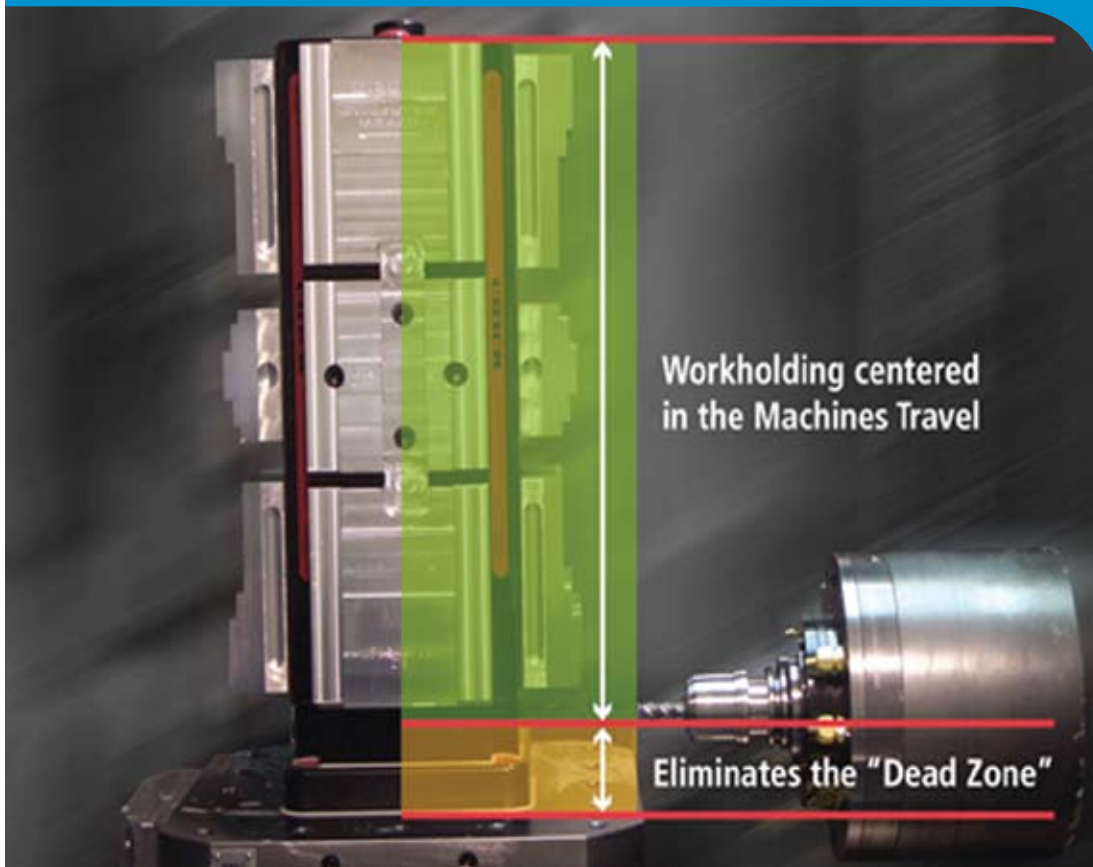

Chick has taken the work out of choosing workholding for your machine by designing Workholding Packages specifically for your vertical or horizontal machining center. Every Workholding Package from Chick is designed to optimize your machining center's work envelope and ships complete with all necessary hardware required for installation.

WORKHOLDING PACKAGES INCREASE YOUR EFFICIENCY WITH:

- OPTIMAL PLACEMENT IN YOUR WORK ENVELOPE
- ELIMINATION OF THE 'DEAD ZONE' ON YOUR HMC
- OPTIMUM PRODUCTIVITY ON YOUR VMC
- ENHANCED RIGIDITY COMPARED TO OTHER DESIGNS
- OUT-OF-THE-BOX INSTALLATION

MOST POPULAR HORIZONTAL WORKHOLDING PACKAGES

Each Workholding Package is designed for your machine with all of the corresponding hardware and interface equipment that makes efficiency as simple as putting your package on your machine and making parts.

Haas EC-400



5HP-HAAS-00025

Mazak HCN 5000



5HP-MAZA-00048

Kitamura HX-300iF



5HP-KITA-00034

Matsuura H+300



5HP-MATS-00058

Doosan Infracore DHP 4000



5HP-DAEW-00049

Haas EC-300



5HP-HAAS-00016

Kitamura HX-400iF



5HP-KITA-00035

Makino A-61



5HP-MAKI-00021

Makino A-51



5HP-MAKI-00039

Mori-Seiki NH-4000



5HP-MORI-00066

Mori-Seiki NH-5000



5HP-MORI-00077

Okuma MA-400



5HP-OKUM-00057

Additional Workholding Packages are available for these and other machining centers at www.ChickWorkholding.com or call 1-800-332-4425.

MOST POPULAR VERTICAL WORKHOLDING PACKAGES

Each Workholding Package is designed for your machine with all of the corresponding hardware and interface equipment that makes efficiency as simple as putting your package on your machine and making parts.

Haas VF-3



5VP-HAAS-00198

Mazak Nexus 510C



5VP-MAZA-00063

Fadal VMC 4020



5VP-FADA-00024

Fanuc RoboDrill Mate



5VP-ROBO-00021

Doosan Infracore DMV 4020



5VP-DAEW-00044

Fadal VMC 3016



5VP-FADA-00039

Haas VF-5



5VP-HAAS-00101

Haas VF-2



5VP-HAAS-00192

Haas MiniMill



5VP-HAAS-00218

Hurco VM-1



5VP-HURC-00002

Mori-Seiki NV-5000B



5VP-MORI-00088

Okuma MCV 4020



5VP-OKUM-00037

Additional Workholding Packages are available for these and other machining centers at www.ChickWorkholding.com or call 1-800-332-4425.

VERTICAL WORKHOLDING

FOUNDATION

The Foundation's standard grid pattern simplifies designing, cataloging, and utilization of your fixtures, providing consistency and repeatability to your set-ups.

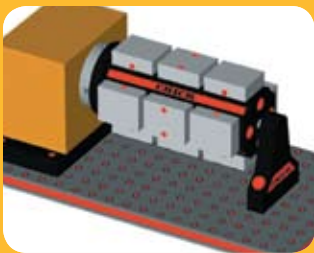
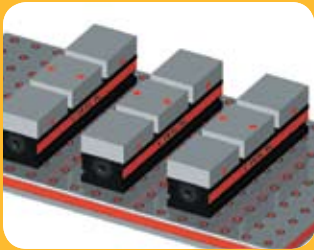

The perfect solution for repeat fixture setups.

- Precision ground cast iron to 35mm thick.
- Length and width tailored to the machine's work envelope.
- 50mm grid pattern of bushed and tapped holes.

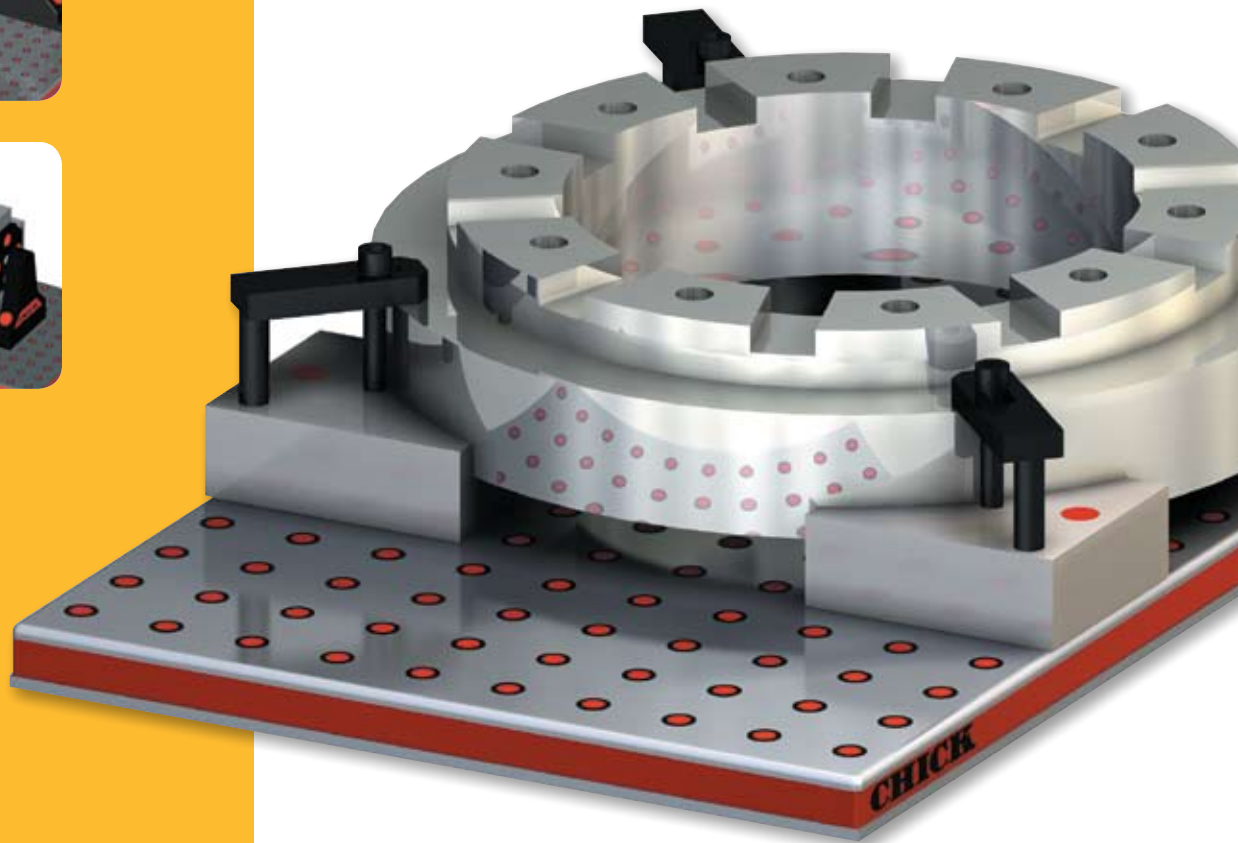

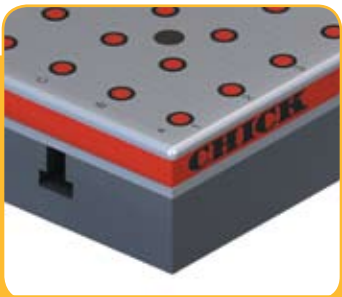

FOUNDATION DESIGN

All Foundations incorporate an alpha-numeric labeling system to simplify building and cataloging of fixtures.



FIXTURE MOUNTING HOLES

Each hole within the 50mm grid pattern has a 12mm bushing for accurate location and an M12 thread for bolt down. These holes are sealed with patented chip plugs preventing the build up of chips.



MACHINE INTERFACE MOUNTING HOLES

Customized for each machining center. The hardware necessary to mount the Foundation to your table is included.

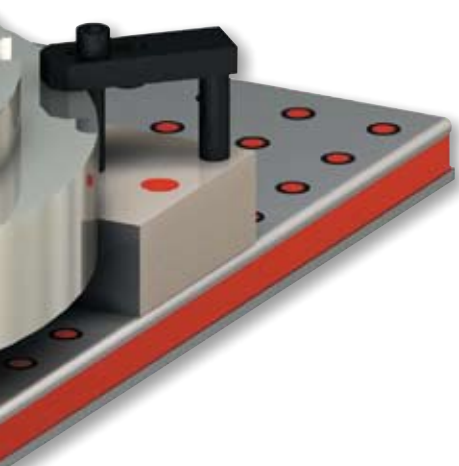

ACCESSORIES

FOUNDATION BLOX

050-0001



Foundation Blox are blank, high strength aluminum blocks that are machined into a dedicated component of your set-up. Ideal for designing component modular fixtures on Foundations. Use Accurate Bolts for unparallelled repeatability.

ACCURATE BOLTS

050-0002



These M12 bolts have a ground shoulder that provides precision repeatability when using Foundation Blox or any other modular fixturing components.

Each Foundation is tailored to fit your machine's specifications. Due to the variety of machines, please contact CHICK to obtain the appropriate Foundation order number.

VERTICAL WORKHOLDING

QWIK-LOKS

Take advantage of the dual station clamping benefits thus increasing productivity twofold and amortizing tool change time. Select a base of either high strength aluminum or cast iron and design your fixturing from there. CHICK's wide variety of QwikChange™ accessories (pg's 22-31), provide you with the most flexible system in the industry.



Nested Subplates
For 50mm systems only.
(See page 35 for information)



Qwik-Loks are most efficient when machining on one or opposing part sides.

All dimensions and systems include standard jaws.

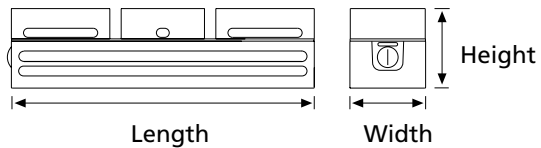

Holding Capacity

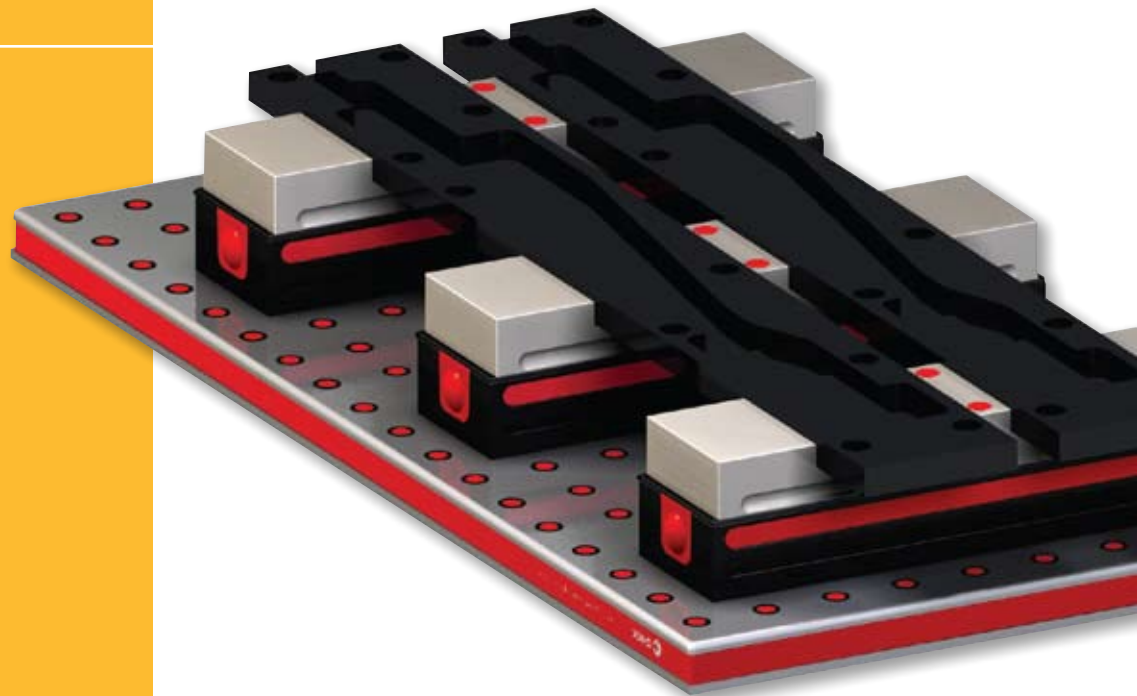
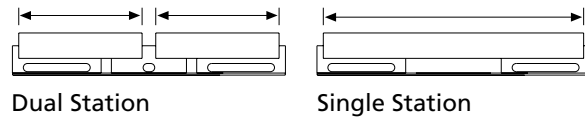

0520 Qwik-Lok
081-1200



Dimensions	mm	(inch)
Height	75	(2.95)
Width	50	(1.97)
Length	203	(7.99)

Weight	kg	(lbs)
	2	(5)

Maximum Holding Capacity		
	mm	(inch)
Dual Station	85	(3.35)
2 - Workholding Stations		
Single Station	185	(7.28)
1 - Workholding Station		

Maximum Recommended Torque Clamping Force
2,520 lbs. @ 14 ft-lbs.
(11.2 kN @ 19 N-m)

1030 Qwik-Lok
5QL1030-AL



Dimensions	mm	(inch)
Height	95	(3.74)
Width	100	(3.94)
Length	305	(12.01)

Weight	kg	(lbs)
	9	(19)

Maximum Holding Capacity		
	mm	(inch)
Dual Station	130	(5.12)
2 - Workholding Stations		
Single Station	280	(11.02)
1 - Workholding Station		

Maximum Recommended Torque Clamping Force
5,000 lbs. @ 52 ft-lbs.
(22.0 kN @ 70 N-m)

1540 Qwik-Lok
5QL1540-AL



Dimensions	mm	(inch)
Height	120	(4.72)
Width	150	(5.91)
Length	407	(16.02)

Weight	kg	(lbs)
	21	(46)

Maximum Holding Capacity		
	mm	(inch)
Dual Station	175	(6.89)
2 - Total Workholding Stations		
Single Station	380	(14.96)
1 - Workholding Station		

Maximum Recommended Torque Clamping Force
9,000 lbs. @ 118 ft-lbs.
(40.0 kN @ 160 N-m)

0525 Qwik-Lok
081-1205



Dimensions	mm	(inch)
Height	75	(2.95)
Width	50	(1.97)
Length	253	(9.96)

Weight	kg	(lbs)
	3	(6)

Maximum Holding Capacity		
	mm	(inch)
Dual Station	110	(4.33)
2 - Workholding Stations		
Single Station	235	(9.25)
1 - Workholding Station		

Maximum Recommended Torque Clamping Force
2,520 lbs. @ 14 ft-lbs.
(11.2 kN @ 19 N-m)

1040 Qwik-Lok
Aluminum Base **5QL1040-AL**
Cast Iron Base **5QL1040-CI**



Dimensions	mm	(inch)
Height	95	(3.74)
Width	100	(3.94)
Length	405	(15.94)

Weight	kg	(lbs)
Aluminum Base	11	(24)
Cast Iron Base	18	(39)

Maximum Holding Capacity		
	mm	(inch)
Dual Station	180	(7.09)
2 - Workholding Stations		
Single Station	380	(14.96)
1 - Workholding Station		

Maximum Recommended Torque Clamping Force
5,000 lbs. @ 52 ft-lbs.
(22.0 kN @ 70 N-m)

1550 Qwik-Lok
Aluminum Base **5QL1550-AL**
Cast Iron Base **5QL1550-CI**



Dimensions	mm	(inch)
Height	120	(4.72)
Width	150	(5.91)
Length	507	(19.96)

Weight	kg	(lbs)
Aluminum Base	24	(54)
Cast Iron Base	41	(89)

Maximum Holding Capacity		
	mm	(inch)
Dual Station	225	(8.86)
2 - Workholding Stations		
Single Station	480	(18.90)
1 - Workholding Station		

Maximum Recommended Torque Clamping Force
9,000 lbs. @ 118 Ft-lbs.
(40.0 kN @ 160 N-m)



VERTICAL WORKHOLDING

INDEXER SUBSYSTEM

Obtain the benefits of a horizontal CNC machine on a vertical CNC machine, by using CHICK's Indexer Subsystem package (ISS). Utilize the indexer you have and marry it to one of CHICK's Multi-Loks. The ISS gives you the ability to machine on multiple part sides with only one clamping, therefore decreasing the cycle time and increasing accuracy of your part.



Indexer Subsystem (ISS) is most commonly used when fractional degree indexing is required.

All dimensions and systems include standard jaws. Indexer not included. Additional center height is available with riser blocks.

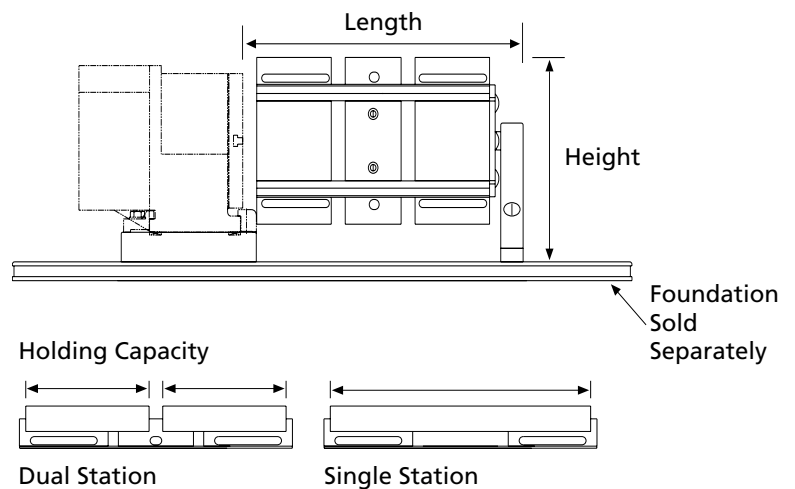

0520 (X2) 4 Sided ISS
ISS-082-4202



Dimensions mm (inch)
Length 505 (19.88)
Height 305 (12.01)
Multi-Lok Specifications, Pages 15-20

Maximum
Holding Capacity mm (inch)
Dual Station 85 (3.35)
16 - Workholding Stations
Single Station 185 (7.28)
8 - Workholding Stations

Maximum Recommended Torque Clamping Force
2,520 lbs. @ 14 ft-lbs.
(11.2 kN @ 19 N-m)

1040 6 Sided ISS
5IS1040-61



Dimensions mm (inch)
Length 505 (19.88)
Height 350 (13.76)
Multi-Lok Specifications, Pages 15-20

Maximum
Holding Capacity mm (inch)
Dual Station 180 (7.09)
12 - Workholding Stations
Single Station 380 (14.96)
6 - Workholding Stations

Maximum Recommended Torque Clamping Force
5,000 lbs. @ 52 ft-lbs.
(22.0 kN @ 70 N-m)

1550 4 Sided ISS
5IS1550-41



Dimensions mm (inch)
Length 605 (23.82)
Height 450 (17.72)
Multi-Lok Specifications, Pages 15-20

Maximum
Holding Capacity mm (inch)
Dual Station 225 (8.86)
8 - Workholding Stations
Single Station 480 (18.90)
4 - Workholding Stations

Maximum Recommended Torque Clamping Force
9,000 lbs. @ 118 ft-lbs.
(40.0 kN @ 160 N-m)

0525 4 Sided ISS
ISS-082-4201



Dimensions mm (inch)
Length 355 (13.98)
Height 305 (12.01)
Multi-Lok Specifications, Pages 15-20

Maximum
Holding Capacity mm (inch)
Dual Station 110 (4.33)
8 - Workholding Stations
Single Station 235 (9.25)
4 - Workholding Stations

Maximum Recommended Torque Clamping Force
2,520 lbs. @ 14 ft-lbs.
(11.2 kN @ 19 N-m)

1040 4 Sided ISS
5IS1040-41



Dimensions mm (inch)
Length 505 (19.88)
Height 320 (12.60)
Multi-Lok Specifications, Pages 15-20

Maximum
Holding Capacity mm (inch)
Dual Station 180 (7.09)
8 - Workholding Stations
Single Station 380 (14.96)
4 - Workholding Stations

Maximum Recommended Torque Clamping Force
5,000 lbs. @ 52 ft-lbs.
(22.0 kN @ 70 N-m)



All Indexer Subsystems are compatible with CHICK's 4 Sided, 6 Sided and Specialty (small parts) Multi-Loks.

If you don't find the product you are looking for here, select a Multi-Lok from pages 15-20.

VERTICAL WORKHOLDING

PNEU-DEX

Take the Indexer Subsystem concept a step further. Pneu-Dex's slim indexer allows the Pneu-Dex to be mounted in the Y axis, thus providing usable space to mount either multiple Pneu-Dex's, a Pneu-Dex with large plate work or a Pneu-Dex with several Qwik-Loks. Included with the purchase of any Pneu-Dex package is a Foundation and factory installation by CHICK.



All dimensions and systems include standard jaws. Additional center height is available with riser blocks.

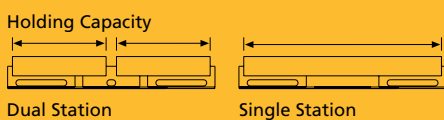
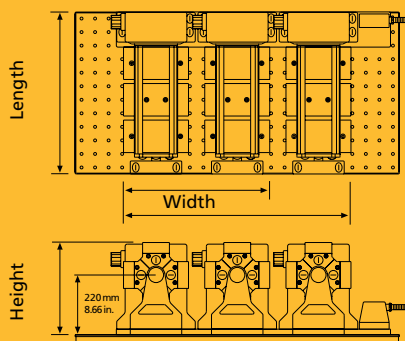

Pneu-Dex is the optimal solution for your machine, combining all of the following features into one footprint:

- Zero Index time with multiple Pneu-Dex.
- Machine three part sides with only one clamping.
- QwikChange™ flexibility.
- Amortization of tool change time.
- Accurate 5° incremental indexing.
- Off center rigidity of 515 ft-lbs. (700N-m)
- Accuracy of ± 5 arc seconds.



0520 (X2)
4 Sided Double Pneu-Dex
MPD082-4202-2



Dimensions	mm	(inch)
Length	598	(23.54)
Width	590	(23.23)
Height	370	(14.57)

Multi-Lok Specifications, Page 15

Maximum Holding Capacity	mm	(inch)
Dual Station	85	(3.35)
32 - Workholding Stations		
Single Station	185	(7.28)
16 - Workholding Stations		

Maximum Recommended Torque Clamping Force
 2,520 lbs. @ 14 ft-lbs.
 (11.2 kN @ 19 N-m)

1040
4 Sided Double Pneu-Dex
SPD1040-41-02



Dimensions	mm	(inch)
Length	598	(23.54)
Width	590	(23.23)
Height	375	(14.76)

Multi-Lok Specifications, Page 15

Maximum Holding Capacity	mm	(inch)
Dual Station	180	(7.09)
16 - Workholding Stations		
Single Station	380	(14.96)
8 - Workholding Stations		

Maximum Recommended Torque Clamping Force
 5,000 lbs. @ 52 ft-lbs.
 (22.0 kN @ 70 N-m)

0525
4 Sided Double Pneu-Dex
MPD082-4201-2

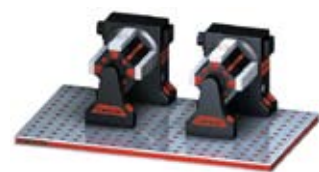

Dimensions	mm	(inch)
Length	448	(17.64)
Width	590	(23.23)
Height	370	(14.57)

Multi-Lok Specifications, Page 15

Maximum Holding Capacity	mm	(inch)
Dual Station	110	(4.33)
16 - Workholding Stations		
Single Station	235	(9.25)
8 - Workholding Stations		

Maximum Recommended Torque Clamping Force
 2,520 lbs. @ 14 ft-lbs.
 (11.2 kN @ 19 N-m)

0520 (X2)
4 Sided Triple Pneu-Dex
MPD082-4202-3



Dimensions	mm	(inch)
Length	598	(23.54)
Width	890	(35.04)
Height	370	(14.57)

Multi-Lok Specifications, Page 15

Maximum Holding Capacity	mm	(inch)
Dual Station	85	(3.35)
48 - Workholding Stations		
Single Station	185	(7.28)
24 - Workholding Stations		

Maximum Recommended Torque Clamping Force
 2,520 lbs. @ 14 ft-lbs.
 (11.2 kN @ 19 N-m)

1040
4 Sided Triple Pneu-Dex
SPD1040-41-03



Dimensions	mm	(inch)
Length	598	(23.54)
Width	890	(35.04)
Height	375	(14.76)

Multi-Lok Specifications, Page 15

Maximum Holding Capacity	mm	(inch)
Dual Station	180	(7.09)
24 - Workholding Stations		
Single Station	380	(14.96)
12 - Workholding Stations		

Maximum Recommended Torque Clamping Force
 5,000 lbs. @ 52 ft-lbs.
 (22.0 kN @ 70 N-m)



All Pneu-Dex systems are compatible with 50mm (2") or 100mm (4") 4 Sided, 6 Sided and Specialty (small parts) Multi-Loks.

If you don't find the product you are looking for here, select a Multi-Lok from pages 15-20.

Single Pneu-Dex solutions are also available.

HORIZONTAL WORKHOLDING

4 SIDED MULTI-LOKS

4 Sided Multi-Loks take full advantage of your horizontal CNC machine by providing the accessibility of three part sides (per station), thus decreasing the cycle time and increasing the accuracy of your part.



All dimensions and systems include standard jaws.

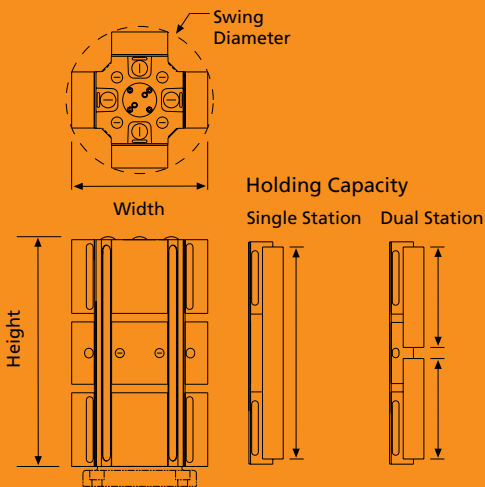

Baseplate not included.
For Baseplate information, see pages 32-33.

4 Sided Multi-Loks are the most versatile products of their kind.

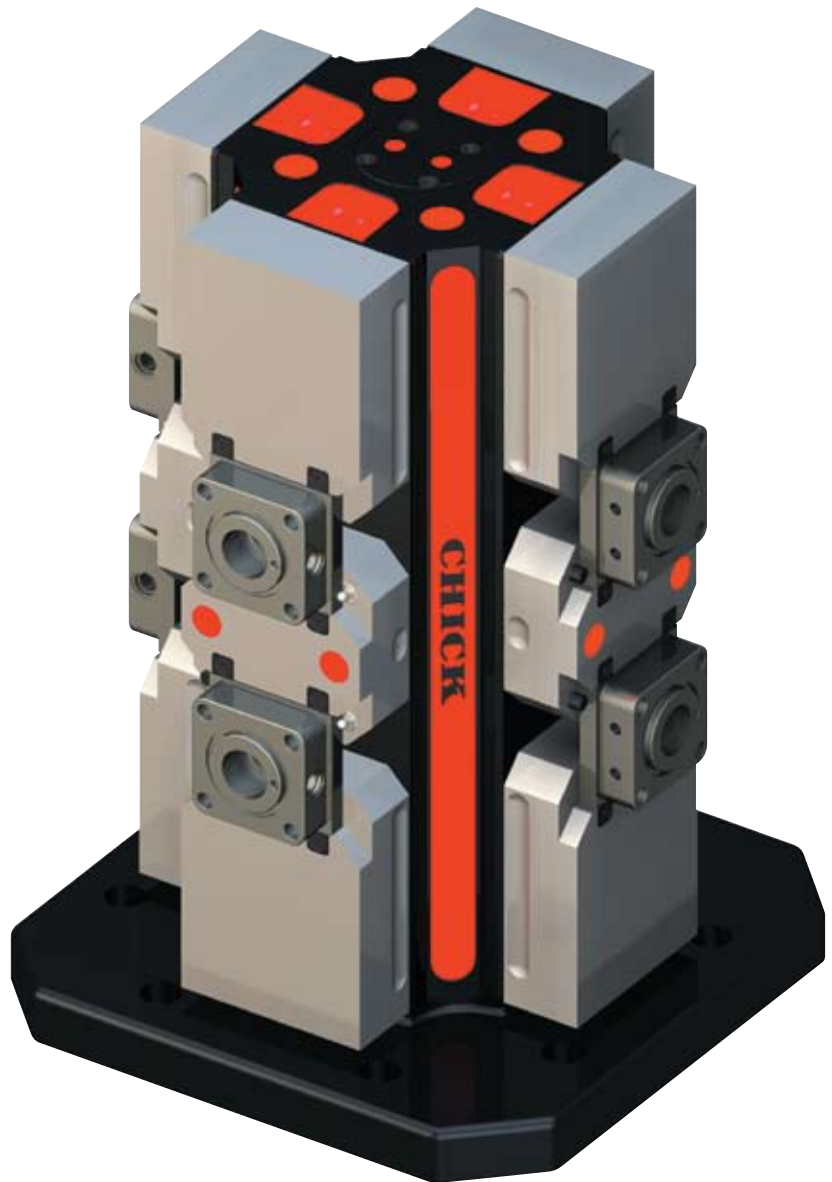

0520 4 sided Multi-Lok
082-4200



Dimensions	mm	(inch)
Height	203	(7.99)
Width	210	(8.27)
Swing Diameter	216	(8.49)

Weight	kg	(lbs)
	15	(33)

Maximum Holding Capacity	mm	(inch)
Dual Station	85	(3.35)
8 - Workholding Stations		
Single Station	185	(7.28)
4 - Workholding Stations		

Maximum Recommended Torque Clamping Force

2,520 lbs. @ 14 ft-lbs.
(11.2 kN @ 19 N-m)

1030 4 sided Multi-Lok
5ML1030-41



Dimensions	mm	(inch)
Height	305	(12.01)
Width	240	(9.45)
Swing Diameter	260	(10.24)

Weight	kg	(lbs)
	37	(81)

Maximum Holding Capacity	mm	(inch)
Dual Station	130	(5.12)
8 - Workholding Stations		
Single Station	280	(11.02)
4 - Workholding Stations		

Maximum Recommended Torque Clamping Force

5,000 lbs. @ 52 ft-lbs.
(22.0 kN @ 70 N-m)

1540 4 sided Multi-Lok
5ML1540-41



Dimensions	mm	(inch)
Height	407	(16.02)
Width	300	(11.81)
Swing Diameter	334	(13.15)

Weight	kg	(lbs)
	80	(177)

Maximum Holding Capacity	mm	(inch)
Dual Station	175	(6.89)
8 - Workholding Stations		
Single Station	380	(14.96)
4 - Workholding Stations		

Maximum Recommended Torque Clamping Force

9,000 lbs. @ 118 ft-lbs.
(40.0 kN @ 160 N-m)

0525 4 sided Multi-Lok
082-4201

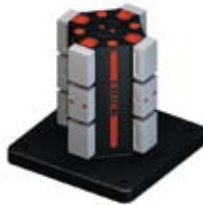

Dimensions	mm	(inch)
Height	253	(9.96)
Width	210	(8.27)
Swing Diameter	216	(8.49)

Weight	kg	(lbs)
	19	(42)

Maximum Holding Capacity	mm	(inch)
Dual Station	110	(4.33)
8 - Workholding Stations		
Single Station	235	(9.25)
4 - Workholding Stations		

Maximum Recommended Torque Clamping Force

2,520 lbs. @ 14 ft-lbs.
(11.2 kN @ 19 N-m)

1040 4 sided Multi-Lok
5ML1040-41



Dimensions	mm	(inch)
Height	405	(15.94)
Width	240	(9.45)
Swing Diameter	260	(10.24)

Weight	kg	(lbs)
	47	(103)

Maximum Holding Capacity	mm	(inch)
Dual Station	180	(7.09)
8 - Workholding Stations		
Single Station	380	(14.96)
4 - Workholding Stations		

Maximum Recommended Torque Clamping Force

5,000 lbs. @ 52 ft-lbs.
(22.0 kN @ 70 N-m)

1550 4 sided Multi-Lok
5ML1550-41



Dimensions	mm	(inch)
Height	507	(19.96)
Width	300	(11.81)
Swing Diameter	334	(13.15)

Weight	kg	(lbs)
	93	(206)

Maximum Holding Capacity	mm	(inch)
Dual Station	225	(8.86)
8 - Workholding Stations		
Single Station	480	(18.90)
4 - Workholding Stations		

Maximum Recommended Torque Clamping Force

9,000 lbs. @ 118 ft-lbs.
(40.0 kN @ 160 N-m)

HORIZONTAL WORKHOLDING

6 SIDED MULTI-LOKS

6 Sided Multi-Loks provide the flexibility and versatility of six complete dual station workspaces in one compact footprint maximizing the quantity of parts presented to the spindle.



All dimensions and systems include standard jaws.

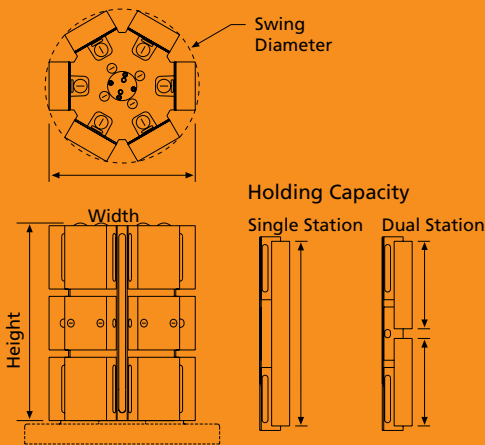

Baseplate not included.
For Baseplate information, see pages 32-33.

6 Sided Multi-Loks are most commonly used with applications requiring high volume production.

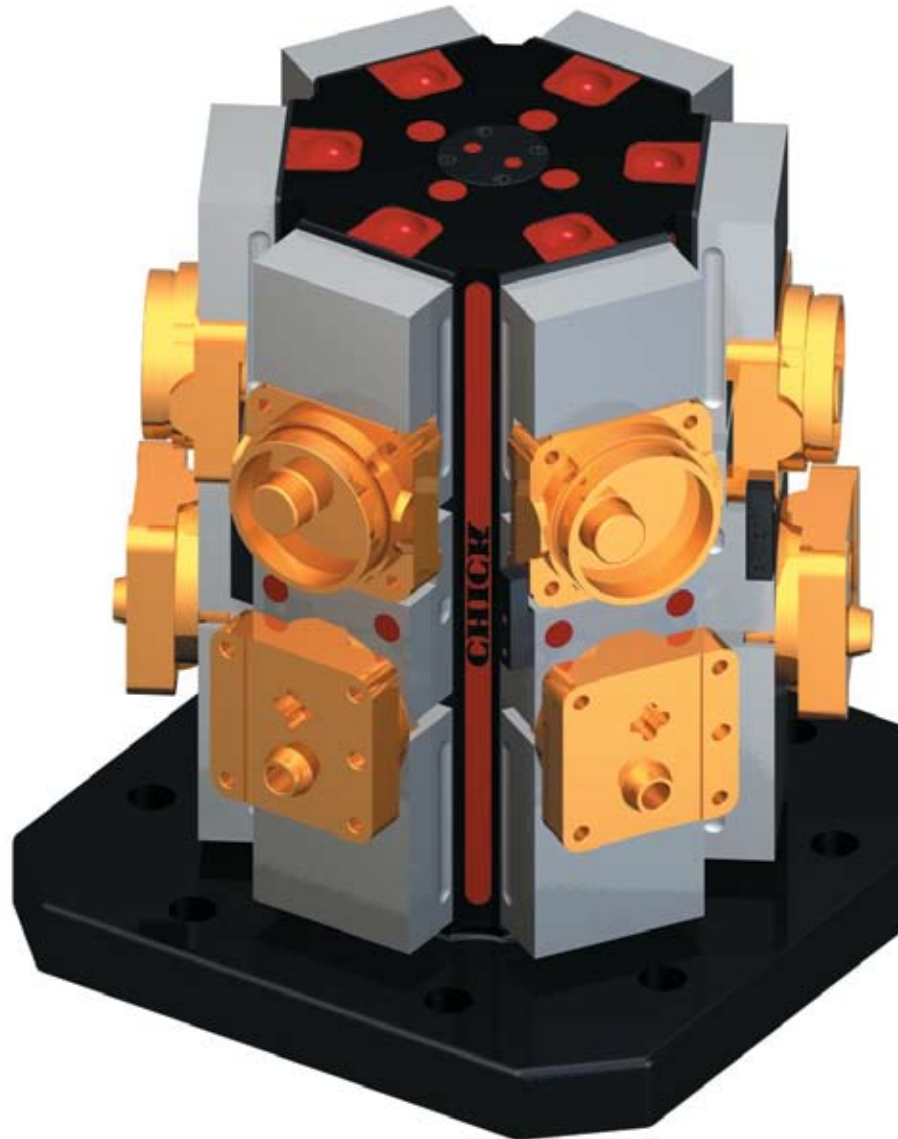

**0520 6 sided Multi-Lok
082-6200**



Dimensions	mm	(inch)
Height	203	(7.99)
Width	230	(9.06)
Swing Diameter	235	(9.25)

Weight	kg	(lbs)
	20	(44)

Maximum Holding Capacity	mm	(inch)
Dual Station 12 - Workholding Stations	85	(3.35)
Single Station 6 - Workholding Stations	185	(7.28)

**Maximum Recommended
Torque Clamping Force**

2,520 lbs. @ 14 ft-lbs.
(11.2 kN @ 19 N-m)

**1030 6 sided Multi-Lok
5ML1030-61**



Dimensions	mm	(inch)
Height	305	(12.01)
Width	300	(11.81)
Swing Diameter	316	(12.44)

Weight	kg	(lbs)
	58	(128)

Maximum Holding Capacity	mm	(inch)
Dual Station 12 - Workholding Stations	130	(5.12)
Single Station 6 - Workholding Stations	280	(11.02)

**Maximum Recommended
Torque Clamping Force**

5,000 lbs. @ 52 ft-lbs.
(22.0 kN @ 70 N-m)

**1540 6 sided Multi-Lok
5ML1540-61**



Dimensions	mm	(inch)
Height	407	(16.02)
Width	410	(16.14)
Swing Diameter	436	(17.17)

Weight	kg	(lbs)
	138	(304)

Maximum Holding Capacity	mm	(inch)
Dual Station 12 - Workholding Stations	175	(6.89)
Single Station 6 - Workholding Stations	380	(14.96)

**Maximum Recommended
Torque Clamping Force**

9,000 lbs. @ 118 ft-lbs.
(40.0 kN @ 160 N-m)

**0525 6 sided Multi-Lok
082-6201**

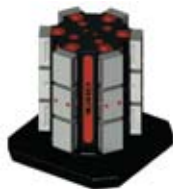

Dimensions	mm	(inch)
Height	253	(9.96)
Width	230	(9.06)
Swing Diameter	235	(9.25)

Weight	kg	(lbs)
	23	(51)

Maximum Holding Capacity	mm	(inch)
Dual Station 12 - Workholding Stations	110	(4.33)
Single Station 6 - Workholding Stations	235	(9.25)

**Maximum Recommended
Torque Clamping Force**

2,520 lbs. @ 14 ft-lbs.
(11.2 kN @ 19 N-m)

**1040 6 sided Multi-Lok
5ML1040-61**



Dimensions	mm	(inch)
Height	405	(15.94)
Width	300	(11.81)
Swing Diameter	316	(12.44)

Weight	kg	(lbs)
	75	(165)

Maximum Holding Capacity	mm	(inch)
Dual Station 12 - Workholding Stations	180	(7.09)
Single Station 6 - Workholding Stations	380	(14.96)

**Maximum Recommended
Torque Clamping Force**

5,000 lbs. @ 52 ft-lbs.
(22.0 kN @ 70 N-m)

**1550 6 sided Multi-Lok
5ML1550-61**



Dimensions	mm	(inch)
Height	507	(19.96)
Width	410	(16.14)
Swing Diameter	436	(17.17)

Weight	kg	(lbs)
	162	(356)

Maximum Holding Capacity	mm	(inch)
Dual Station 12 - Workholding Stations	225	(8.86)
Single Station 6 - Workholding Stations	480	(18.90)

**Maximum Recommended
Torque Clamping Force**

9,000 lbs. @ 118 ft-lbs.
(40.0 kN @ 160 N-m)

HORIZONTAL WORKHOLDING

SPECIALTY MULTI-LOKS (SMALL PARTS)

Specialty Multi-Loks are designed with specific applications in mind. CHICK has developed a group of Multi-Loks for small part applications or machines with a limited work envelope, without sacrificing the simplicity and flexibility of the System 5 product line.

Finally, workholding designed with your application in mind!



All dimensions and systems include standard jaws.

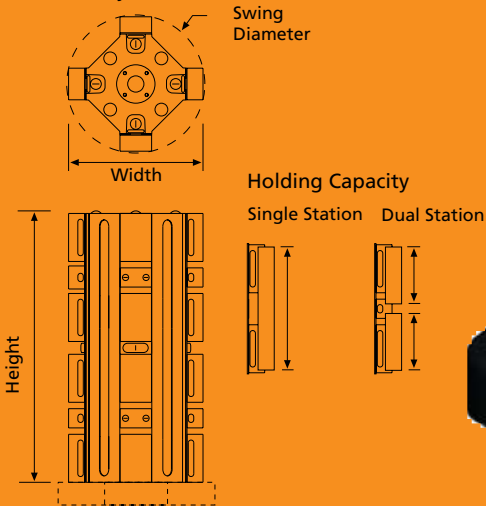

Baseplate not included.
For Baseplate information, see pages 32-33.

Specialty Multi-Loks are the perfect solution for small part applications or machines with a limited work envelope.



**0520 (x2) 4 sided Multi-Lok
082-4202**



Dimensions		mm	(inch)
Height		423	(16.65)
Width		210	(8.27)
Swing Diameter		216	(8.49)

Weight		kg	(lbs)
		30	(65)

Maximum Holding Capacity		mm	(inch)
Dual Station		85	(3.35)
16 - Workholding Stations			
Single Station		185	(7.28)
8 - Workholding Stations			

Maximum Recommended Torque Clamping Force

2,520 lbs. @ 14 ft-lbs.
(11.2 kN @ 19 N-m)

**0520 (x2) 6 sided Multi-Lok
082-6202**

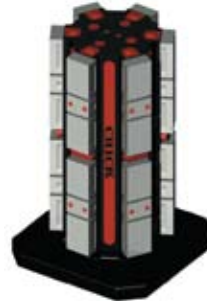

Dimensions		mm	(inch)
Height		423	(16.65)
Width		230	(9.06)
Swing Diameter		235	(9.25)

Weight		kg	(lbs)
		40	(88)

Maximum Holding Capacity		mm	(inch)
Dual Station		85	(3.35)
24 - Workholding Stations			
Single Station		185	(7.28)
12 - Workholding Stations			

Maximum Recommended Torque Clamping Force

2,520 lbs. @ 14 ft-lbs.
(11.2 kN @ 19 N-m)

HORIZONTAL WORKHOLDING

SPECIALTY MULTI-LOKS (LARGE PARTS)

This grouping of Specialty Multi-Loks is designed to hold large parts while maximizing the efficiency of your machine. No need to waste time completely switching fixtures. Simply, select the Multi-Lok that fits in your machining envelope and change your setups in minutes.

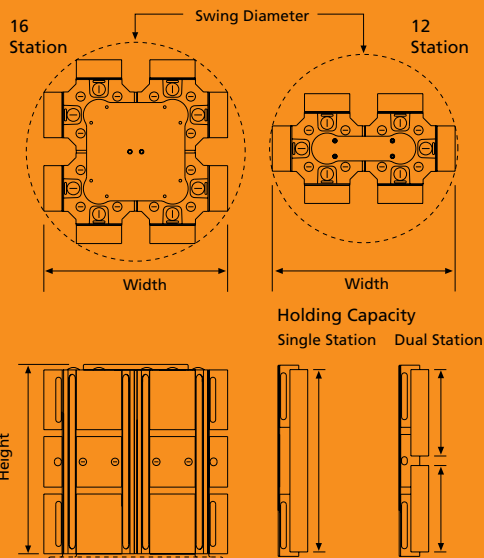

All dimensions and systems include standard jaws.

Every 12- and 16-Station Multi-Lok must be shipped with a baseplate.

For Baseplate information, see pages 32-33.

12 & 16 Station Multi-Loks provide the flexibility of being able to hold one extremely large part over multiple stations or clamping multiple average sized parts.



1040 12 Station Multi-Lok
5ML1040-41-12



Dimensions	mm	(inch)
Height	412	(16.22)
Width	400	(15.75)
Swing Diameter	412	(16.22)

Weight	kg	(lbs)
	82	(180)

Maximum Holding Capacity	mm	(inch)
Dual Station	180	(7.09)
12 - Workholding Stations		
Single Station	380	(14.96)
6 - Workholding Stations		

Maximum Recommended Torque Clamping Force

5,000 lbs. @ 52 ft-lbs.
(22.0 kN @ 70 N-m)

1550 12 Station Multi-Lok
5ML1550-41-12



Dimensions	mm	(inch)
Height	519	(20.43)
Width	500	(19.69)
Swing Diameter	520	(20.51)

Weight	kg	(lbs)
	188	(414)

Maximum Holding Capacity	mm	(inch)
Dual Station	225	(8.86)
16 - Workholding Stations		
Single Station	480	(18.90)
8 - Workholding Stations		

Maximum Recommended Torque Clamping Force

9,000 lbs. @ 118 ft-lbs.
(40.0 kN @ 160 N-m)

1040 16 Station Multi-Lok
5ML1040-41-16



Dimensions	mm	(inch)
Height	412	(16.22)
Width	400	(15.75)
Swing Diameter	476	(18.74)

Weight	kg	(lbs)
	140	(308)

Maximum Holding Capacity	mm	(inch)
Dual Station	180	(7.09)
12 - Workholding Stations		
Single Station	380	(14.96)
6 - Workholding Stations		

Maximum Recommended Torque Clamping Force

5,000 lbs. @ 52 ft-lbs.
(22.0 kN @ 70 N-m)

1550 16 Station Multi-Lok
5ML1550-41-16



Dimensions	mm	(inch)
Height	519	(20.43)
Width	500	(19.69)
Swing Diameter	609	(23.98)

Weight	kg	(lbs)
	274	(603)

Maximum Holding Capacity	mm	(inch)
Dual Station	225	(8.86)
16 - Workholding Stations		
Single Station	480	(18.90)
8 - Workholding Stations		

Maximum Recommended Torque Clamping Force

9,000 lbs. @ 118 ft-lbs.
(40.0 kN @ 160 N-m)

ACCESSORIES (QWIKCHANGE™)

ONE SYSTEM ENDLESS OPPORTUNITIES

Chick Workholding was designed with flexibility in mind!

Maximize your productivity and drastically reduce your repeat setup time, thereby unleashing milling profitability.

GRIPPERS



Ideal for workpieces that require aggressive clamping

See pages 32-33 for ordering information.

Dual Station Machinable Jaw Sets

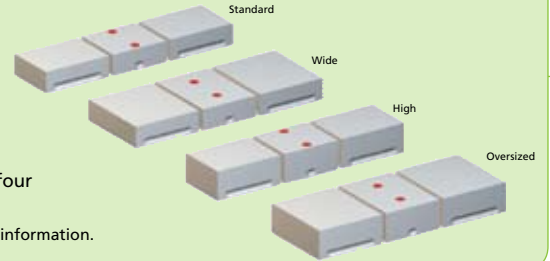

Ideal for holding two or four 3" to 8" parts.

See pages 24-25 for ordering information.

Single Station Machinable Jaw Sets

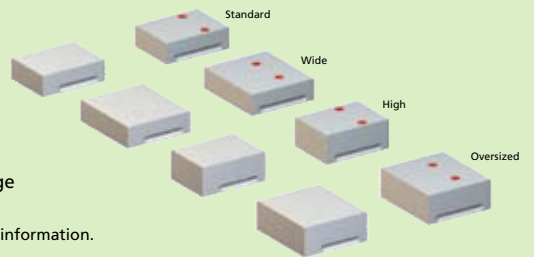

Ideal for holding one large 8" to 19" part.

See pages 26-27 for ordering information.

Machinable Faceplates

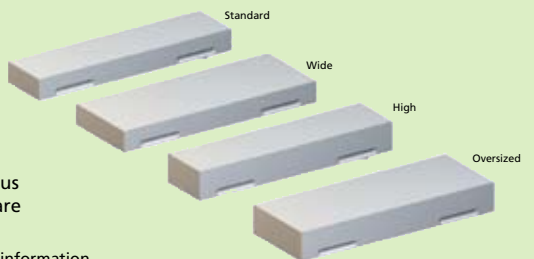

Ideal for holding numerous small parts or parts that are difficult to clamp.

See pages 28-29 for ordering information.

Jaw Carrier Sets

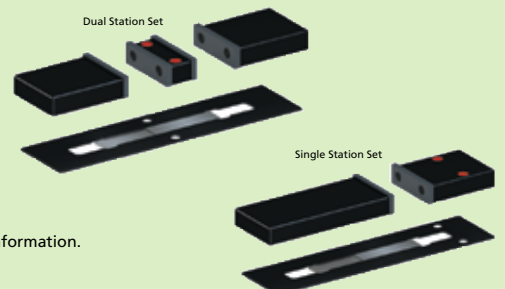

Ideal for "vise like" setup

See pages 30-31 for ordering information.

Conversion Faceplates

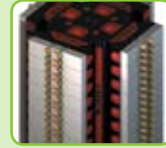
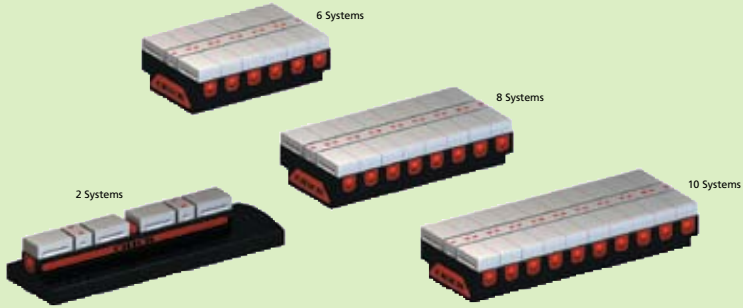

Ideal for clamping a variety of part sizes.
See pages 32-33 for ordering information.

Select from a wide variety of easy set-up machinable accessories:

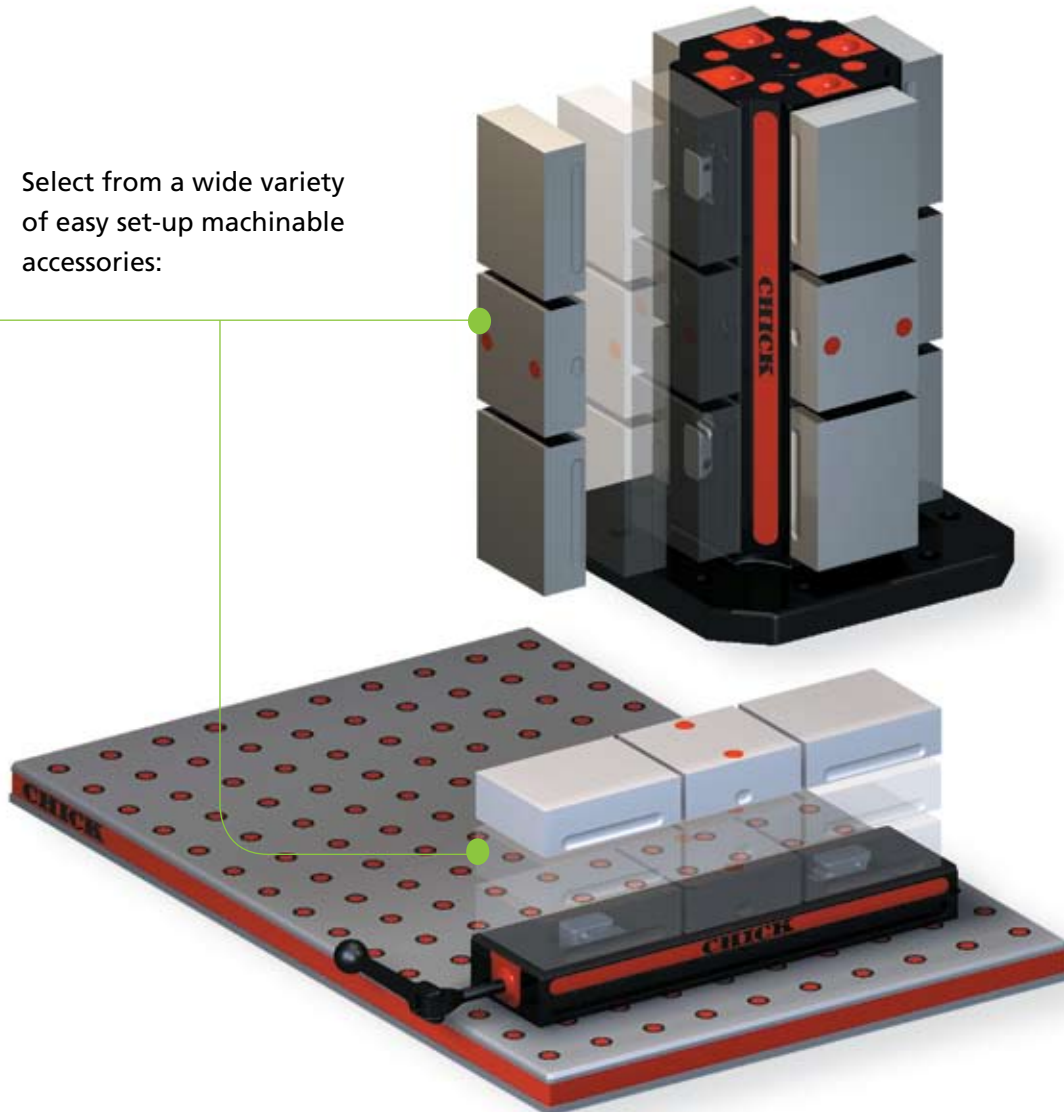

ACCESSORIES (QWIKCHANGE™)

DUAL STATION MACHINABLE JAW SETS

The Dual Station Machinable Jaw Sets clamp with an equal and opposing inward force, thus eliminating the potential for jaw lift. The safe low profile jaw interface maximizes the amount of machinable area, giving the ability to hold larger parts.



Machinable accessories are the optimal solution for repeat set-ups. The standard height and width is suitable for most applications. CHICK has designed wide, high and oversized accessories to provide a cost effective solution for those unique applications.

Standard Jaw Set

Dual Station Machinable

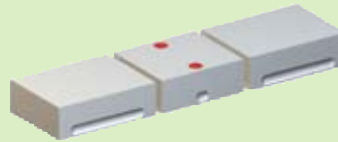

Set includes:
(2) Moveable Jaws
(1) Fixed Center Jaw

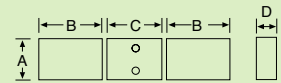

Size

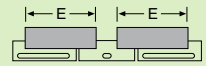

*Max Holding Capacity

High Jaw Set

Dual Station Machinable



Set includes:
(2) Moveable Jaws
(1) Fixed Center Jaw

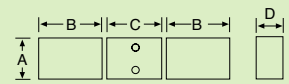

Size

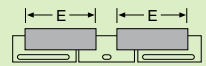

*Max Holding Capacity

Wide Jaw Set

Dual Station Machinable



Set includes:
(2) Moveable Jaws
(1) Fixed Center Jaw

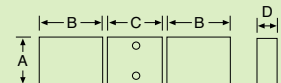

Size

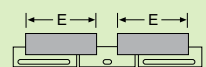

*Max Holding Capacity

Oversized Jaw Set

Dual Station Machinable



Set includes:
(2) Moveable Jaws
(1) Fixed Center Jaw

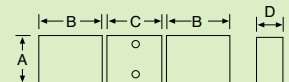

Size

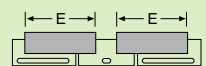

*Max Holding Capacity

For machinable area visit or website www.ChickWorkholding.com

System Sizes

	0520 and 0525		1030 and 1040		1540 and 1550	
Order No.	080-2500	080-2505	5DS 1030-10-40	5DS 1040-10-40	5DS 1540-15-50	5DS 1550-15-50
Dimensions	mm (inch)	mm (inch)	mm (inch)	mm (inch)	mm (inch)	mm (inch)
A	49 (1.93)	49 (1.93)	99 (3.90)	99 (3.90)	148 (5.83)	148 (5.83)
B	75 (2.95)	75 (2.95)	105 (4.13)	130 (5.12)	135 (5.31)	160 (6.30)
C	36 (1.42)	76 (2.99)	70 (2.76)	110 (4.33)	100 (3.94)	140 (5.51)
D	25 (0.98)	25 (0.98)	40 (1.57)	40 (1.57)	50 (1.97)	50 (1.97)
E	85 (3.35)	110 (4.33)	130 (5.12)	180 (7.09)	175 (6.89)	225 (8.86)
Order No.	NOT AVAILABLE IN THIS SIZE		5DS 1030-10-55	5DS 1040-10-55	5DS 1540-15-70	5DS 1550-15-70
Dimensions			mm (inch)	mm (inch)	mm (inch)	mm (inch)
A			99 (3.90)	99 (3.90)	148 (5.83)	148 (5.83)
B			105 (4.13)	130 (5.12)	135 (5.31)	160 (6.30)
C			70 (2.76)	110 (4.33)	100 (3.94)	140 (5.51)
D			55 (2.17)	55 (2.17)	70 (2.76)	70 (2.76)
E	130 (5.12)	180 (7.09)	175 (6.89)	225 (8.86)		
Order No.	NOT AVAILABLE IN THIS SIZE		5DS 1030-15-40	5DS 1040-15-40	5DS 1540-20-50	5DS 1550-20-50
Dimensions			mm (inch)	mm (inch)	mm (inch)	mm (inch)
A			148 (5.83)	148 (5.83)	198 (7.80)	198 (7.80)
B			105 (4.13)	130 (5.12)	135 (5.31)	160 (6.30)
C			70 (2.76)	110 (4.33)	100 (3.94)	140 (5.51)
D			40 (1.57)	40 (1.57)	50 (1.97)	50 (1.97)
E	130 (5.12)	180 (7.09)	175 (6.89)	225 (8.86)		
Order No.	080-2502	080-2506	5DS 1030-15-55	5DS 1040-15-55	5DS 1540-20-70	5DS 1550-20-70
Dimensions	mm (inch)	mm (inch)	mm (inch)	mm (inch)	mm (inch)	mm (inch)
A	80 (3.15)	80 (3.15)	148 (5.83)	148 (5.83)	198 (7.80)	198 (7.80)
B	75 (2.95)	75 (2.95)	105 (4.13)	130 (5.12)	135 (5.31)	160 (6.30)
C	36 (1.42)	76 (2.99)	70 (2.76)	110 (4.33)	100 (3.94)	140 (5.51)
D	35 (1.38)	35 (1.38)	55 (2.17)	55 (2.17)	70 (2.76)	70 (2.76)
E	85 (3.35)	110 (4.33)	130 (5.12)	180 (7.09)	175 (6.89)	225 (8.86)

ACCESSORIES (QWIKCHANGE™)

SINGLE STATION MACHINABLE JAW SETS

Single Station Machinable Jaw Sets increase the flexibility of your system by eliminating the need to completely switch fixtures for jobs requiring greater holding capacity. Simply QwikChange™ the jaws and the set-up is ready in minutes.



Machinable accessories are the optimal solution for repeat set-ups. The standard height and width is suitable for most applications. CHICK has designed wide, high and oversized accessories to provide a cost effective solution for those unique applications.

Standard Jaw Set

Single Station Machinable



Set includes:
(1) Moveable Jaw
(1) Fixed Single Station Jaw

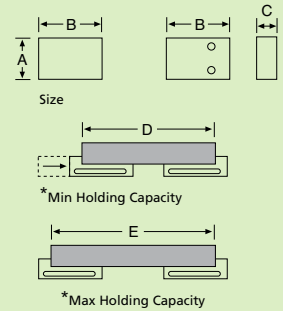

High Jaw Set

Single Station Machinable



Set includes:
(1) Moveable Jaw
(1) Fixed Single Station Jaw

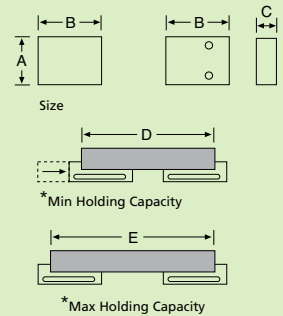

Wide Jaw Set

Single Station Machinable



Set includes:
(1) Moveable Jaw
(1) Fixed Single Station Jaw

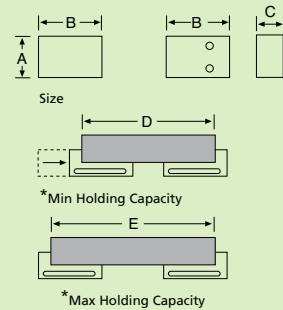

Oversized Jaw Set

Single Station Machinable



Set includes:
(1) Moveable Jaw
(1) Fixed Single Station Jaw

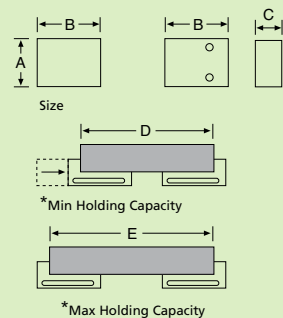

For machinable area visit or website www.ChickWorkholding.com

*CHICK provides a variety of coverplates for extended travel.
Contact CHICK for additional information.

System Sizes

	0520 and 0525		1030 and 1040		1540 and 1550	
Order No.	082-2580	080-2580	5SS 1030-10-40	5SS 1040-10-40	5SS 1540-15-50	5SS 1550-15-50
Dimensions	mm (inch)	mm (inch)	mm (inch)	mm (inch)	mm (inch)	mm (inch)
A	49 (1.91)	49 (1.91)	99 (3.90)	99 (3.90)	148 (5.83)	148 (5.83)
B	75 (2.95)	75 (2.95)	105 (4.13)	130 (5.12)	135 (5.31)	160 (6.30)
C	25 (0.98)	25 (0.98)	40 (1.57)	40 (1.57)	50 (1.97)	50 (1.97)
D	54 (2.13)	99 (3.90)	90 (3.54)	125 (4.92)	125 (4.92)	170 (6.69)
E	185 (7.28)	235 (9.25)	280 (11.02)	380 (14.96)	380 (14.96)	480 (18.90)
Order No.	NOT AVAILABLE IN THIS SIZE		5SS 1030-10-55	5SS 1040-10-55	5SS 1540-15-70	5SS 1550-15-70
Dimensions			mm (inch)	mm (inch)	mm (inch)	mm (inch)
A			99 (3.90)	99 (3.90)	148 (5.83)	148 (5.83)
B			105 (4.13)	130 (5.12)	135 (5.31)	160 (6.30)
C			55 (2.17)	55 (2.17)	70 (2.76)	70 (2.76)
D			90 (3.54)	125 (4.92)	125 (4.92)	170 (6.69)
E	280 (11.02)	380 (14.96)	380 (14.96)	480 (18.90)		
Order No.	NOT AVAILABLE IN THIS SIZE		5SS 1030-15-40	5SS 1040-15-40	5SS 1540-20-50	5SS 1550-20-50
Dimensions			mm (inch)	mm (inch)	mm (inch)	mm (inch)
A			148 (5.83)	148 (5.83)	198 (7.80)	198 (7.80)
B			105 (4.13)	130 (5.12)	135 (5.31)	160 (6.30)
C			40 (1.57)	40 (1.57)	50 (1.97)	50 (1.97)
D			90 (3.54)	125 (4.92)	125 (4.92)	170 (6.69)
E	280 (11.02)	380 (14.96)	380 (14.96)	480 (18.90)		
Order No.	080-2582	080-2582	5SS 1030-15-55	5SS 1040-15-55	5SS 1540-20-70	5SS 1550-20-70
Dimensions	mm (inch)	mm (inch)	mm (inch)	mm (inch)	mm (inch)	mm (inch)
A	80 (3.15)	80 (3.15)	148 (5.83)	148 (5.83)	198 (7.80)	198 (7.80)
B	75 (2.95)	75 (2.95)	105 (4.13)	130 (5.12)	135 (5.31)	160 (6.30)
C	35 (1.38)	35 (1.38)	55 (2.17)	55 (2.17)	70 (2.76)	70 (2.76)
D	54 (2.13)	99 (3.90)	90 (3.54)	125 (4.92)	125 (4.92)	170 (6.69)
E	185 (7.28)	235 (9.25)	280 (11.02)	380 (14.96)	380 (14.96)	480 (18.90)

ACCESSORIES (QWIKCHANGE™)

MACHINABLE FACEPLATES

Machinable Faceplates provide QwikChange™ dedicated fixturing for those awkward parts that are too difficult to clamp. A mini pallet changer can be created by utilizing two Faceplates.

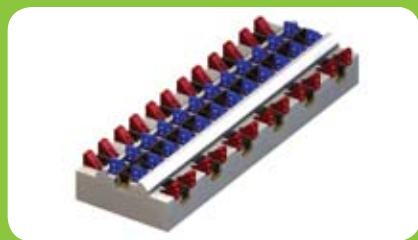

Machinable accessories are the optimal solution for repeat set-ups. The standard height and width is suitable for most applications. CHICK has designed wide, high and oversized accessories to provide a cost effective solution for those unique applications.

Standard Faceplates

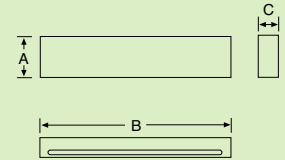

High Faceplates

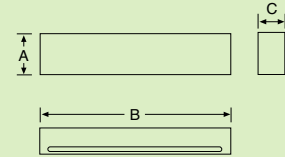

Wide Faceplates

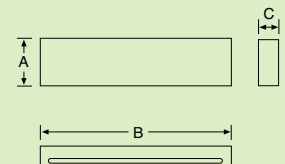

Oversized Faceplates

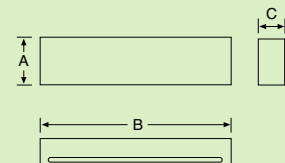

For machinable area detail, visit our website www.ChickWorkholding.com.

System Sizes

	0520 and 0525		1030 and 1040		1540 and 1550	
Order No.	080-2621	080-2625	5FP 1030-10-40	5FP 1040-10-40	5FP 1540-15-50	5FP 1550-15-50
Dimensions	mm (inch)	mm (inch)	mm (inch)	mm (inch)	mm (inch)	mm (inch)
A	49 (1.91)	49 (1.91)	99 (3.90)	99 (3.90)	148 (5.83)	148 (5.83)
B	198 (7.80)	248 (9.76)	298 (11.73)	398 (15.67)	398 (15.67)	498 (19.61)
C	25 (0.98)	25 (0.98)	40 (1.57)	40 (1.57)	50 (1.97)	50 (1.97)
Order No.	NOT AVAILABLE IN THIS SIZE		5FP 1030-10-55	5FP 1040-10-55	5FP 1540-15-70	5FP 1550-15-70
Dimensions			mm (inch)	mm (inch)	mm (inch)	mm (inch)
A			99 (3.90)	99 (3.90)	148 (5.83)	148 (5.83)
B			298 (11.73)	398 (15.67)	398 (15.67)	498 (19.61)
C			55 (2.17)	55 (2.17)	70 (2.76)	70 (2.76)
Order No.	NOT AVAILABLE IN THIS SIZE		5FP 1030-15-40	5FP 1040-15-40	5FP 1540-20-50	5FP 1550-20-50
Dimensions			mm (inch)	mm (inch)	mm (inch)	mm (inch)
A			148 (5.83)	148 (5.83)	198 (7.80)	198 (7.80)
B			298 (11.73)	398 (15.67)	398 (15.67)	498 (19.61)
C			40 (1.57)	40 (1.57)	50 (1.97)	50 (1.97)
Order No.	080-2622	080-2626	5FP 1030-15-55	5FP 1040-15-55	5FP 1540-20-70	5FP 1550-20-70
Dimensions	mm (inch)	mm (inch)	mm (inch)	mm (inch)	mm (inch)	mm (inch)
A	80 (3.15)	80 (3.15)	148 (5.83)	148 (5.83)	198 (7.80)	198 (7.80)
B	198 (7.80)	248 (9.76)	298 (11.73)	398 (15.67)	398 (15.67)	498 (19.61)
C	35 (1.38)	35 (1.38)	55 (2.17)	55 (2.17)	70 (2.76)	70 (2.76)

ACCESSORIES (QWIKCHANGE™)

JAW CARRIER SETS

Jaw Carriers broaden your modern workholding flexibility by offering vise-like fixturing. Simply QwikChange™ the jaws and your modern workholding is ready for vise-like set-ups.



Jaw Carriers are the optimal solution for one-time set-ups or small batch sizes. Jaw Carriers are available in inch and metric as Single Station, Single Station Deluxe and Dual Station Sets for CHICK's 1040 and 1550 workholding systems.

Single Station Set Jaw Carriers

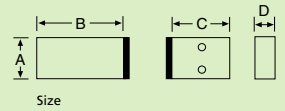
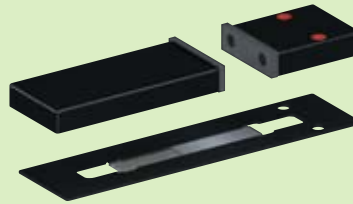

Size

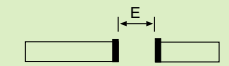

*Holding Capacity
(Max, Min = 0)

- Set includes:
- (1) Long Moveable Jaw Carrier
 - (1) Fixed Single Station Jaw Carrier
 - (1) Single Station Extended Travel Coverplate
- * Hard Jaws not included.

Single Station Deluxe Set Jaw Carriers

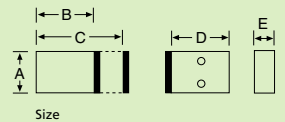
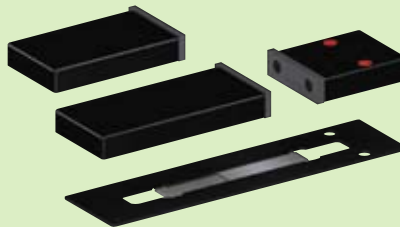

Size

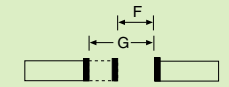

*Short Holding Capacity
(Min, Max)

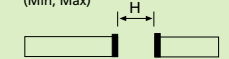

*Long Holding Capacity
(Max, Min = 0)

- Set includes:
- (1) Short Moveable Jaw Carrier
 - (1) Long Moveable Jaw Carrier
 - (1) Fixed Single Station Jaw Carrier
 - (1) Single Station Extended Travel Coverplate
- * Hard Jaws not included.

Dual Station Set Jaw Carriers

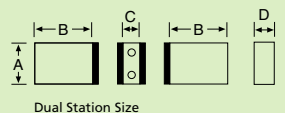
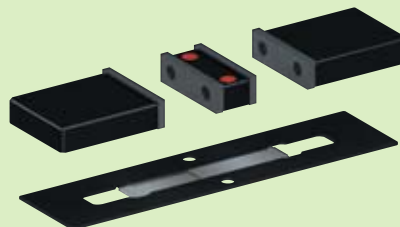

Dual Station Size



*Dual Station Holding Capacity
(Max, Min = 0)

- Set includes:
- (2) Moveable Jaw Carriers
 - (1) Fixed Center Jaw Carrier
 - (1) Dual Station Extended Travel Coverplate
- * Hard Jaws not included.

*The Holding Capacity dimensions are calculated using CHICK's standard Hard Jaws. See **Hard Jaws** dimensional information to make adjustments.

Metric Jaw Carrier Sets are also available, for details contact CHICK.

System Sizes

1040 and 1550

	5JC 1040-SS-IN		5JC 1550-SS-IN	
	mm	(inch)	mm	(inch)
Order No.				
Dimensions				
A	98	(3.86)	148	(5.83)
B	217	(8.54)	287	(11.30)
C	116	(4.57)	135	(5.31)
D	28	(1.10)	38	(1.50)
Holding Capacity				
E	102	(4.00)	110	(4.33)

	5JC 1040-XS-IN		5JC 1550-XS-IN	
	mm	(inch)	mm	(inch)
Order No.				
Dimensions				
A	98	(3.86)	148	(5.83)
B	166	(6.54)	190	(7.48)
C	217	(8.54)	287	(11.30)
D	116	(4.57)	135	(5.31)
E	28	(1.10)	38	(1.50)
Holding Capacity				
F	51	(2.00)	97	(3.82)
G	152	(6.00)	208	(8.19)
H	102	(4.00)	110	(4.33)

	5JC 1040-DS-IN		5JC 1550-DS-IN	
	mm	(inch)	mm	(inch)
Order No.				
Dimensions				
A	98	(3.86)	148	(5.83)
B	116	(4.57)	151	(5.94)
C	50	(1.97)	46	(1.80)
D	28	(1.10)	38	(1.50)
Holding Capacity				
E	52	(2.03)	54	(2.13)

Hard Jaws



These steel hard jaws are perfect for one part applications. Bolt them onto CHICK's jaw carriers and the system is ready to go.

1040 Workholding Systems

Order No. **JH4STD**

Dimensions	mm	(inch)
Height	31	(1.22)
Thickness	9	(0.35)
Width	101	(3.99)

1550 Workholding Systems

Order No. **JH6STD**

Dimensions	mm	(inch)
Height	44	(1.72)
Thickness	12	(0.48)
Width	152	(5.99)

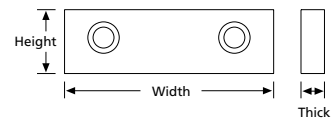

ACCESSORIES (CONVERSION FACEPLATES AND GRIPPERS)

CONVERSIONS FACEPLATES

Maximize your flexibility with the Conversion Faceplates. Conversion Faceplates are ideal for those manufacturer's required to machine a variety of part sizes. Conversion Faceplates can easily convert a system that can hold one 10" part or convert to 10 small systems that hold 20 4" parts.

CONVERSION FACEPLATES



Vertical Conversion Faceplates

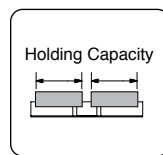

Horizontal Conversion Faceplates

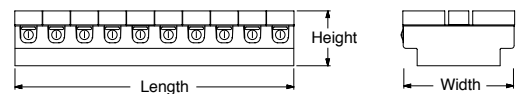

Dimensions include standard dual station 0520 QwikChange machinable jaws.

GRIPPERS

CHICK Grippers are ideal for heavy machining applications in which fixture wear is a major concern. The hardened steel surface provides a clamping interface that eliminates wearing caused by rough cast irons, tool steels, or other hard metals. The CHICK Grippers also increase the holding power of your fixture, since the serrated surface "bites" into the part, for more aggressive workpiece clamping.

GRIPPERS

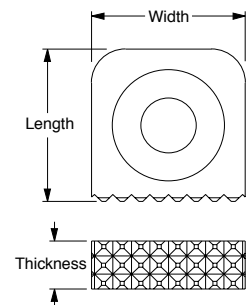

Vertical Conversion Faceplates

Ideal for HMC's and other indexable fixtures

Horizontal Conversion Faceplates

Ideal for High Density fixtures

SYSTEM SIZES

SYSTEM SIZE	Vertical Conversion Faceplate	Horizontal Conversion Faceplate																														
1030	NOT APPLICABLE	<p>6 Systems Order No. 5CF1030-20-06H</p>  <table border="1"> <thead> <tr> <th></th> <th>mm</th> <th>(inch)</th> </tr> </thead> <tbody> <tr> <td>Length</td> <td>298</td> <td>(11.73)</td> </tr> <tr> <td>Width</td> <td>198</td> <td>(7.80)</td> </tr> <tr> <td>Height</td> <td>81</td> <td>(3.19)</td> </tr> <tr> <td>Holding Cap</td> <td>85</td> <td>(3.35)</td> </tr> </tbody> </table>		mm	(inch)	Length	298	(11.73)	Width	198	(7.80)	Height	81	(3.19)	Holding Cap	85	(3.35)															
	mm	(inch)																														
Length	298	(11.73)																														
Width	198	(7.80)																														
Height	81	(3.19)																														
Holding Cap	85	(3.35)																														
1040	<p>2 Systems Order No. 5CF1040-20-02V</p>  <table border="1"> <thead> <tr> <th></th> <th>mm</th> <th>(inch)</th> </tr> </thead> <tbody> <tr> <td>Length</td> <td>419</td> <td>(16.50)</td> </tr> <tr> <td>Width</td> <td>99</td> <td>(3.90)</td> </tr> <tr> <td>Height</td> <td>81</td> <td>(3.19)</td> </tr> <tr> <td>Holding Cap</td> <td>85</td> <td>(3.35)</td> </tr> </tbody> </table>		mm	(inch)	Length	419	(16.50)	Width	99	(3.90)	Height	81	(3.19)	Holding Cap	85	(3.35)	<p>8 Systems Order No. 5CF1040-20-08H</p>  <table border="1"> <thead> <tr> <th></th> <th>mm</th> <th>(inch)</th> </tr> </thead> <tbody> <tr> <td>Length</td> <td>398</td> <td>(15.67)</td> </tr> <tr> <td>Width</td> <td>198</td> <td>(7.80)</td> </tr> <tr> <td>Height</td> <td>81</td> <td>(3.19)</td> </tr> <tr> <td>Holding Cap</td> <td>85</td> <td>(3.35)</td> </tr> </tbody> </table>		mm	(inch)	Length	398	(15.67)	Width	198	(7.80)	Height	81	(3.19)	Holding Cap	85	(3.35)
	mm	(inch)																														
Length	419	(16.50)																														
Width	99	(3.90)																														
Height	81	(3.19)																														
Holding Cap	85	(3.35)																														
	mm	(inch)																														
Length	398	(15.67)																														
Width	198	(7.80)																														
Height	81	(3.19)																														
Holding Cap	85	(3.35)																														
1540	<p>2 Systems Order No. 5CF1540-20-02V</p>  <table border="1"> <thead> <tr> <th></th> <th>mm</th> <th>(inch)</th> </tr> </thead> <tbody> <tr> <td>Length</td> <td>419</td> <td>(16.50)</td> </tr> <tr> <td>Width</td> <td>148</td> <td>(5.83)</td> </tr> <tr> <td>Height</td> <td>98</td> <td>(3.86)</td> </tr> <tr> <td>Holding Cap</td> <td>85</td> <td>(3.35)</td> </tr> </tbody> </table>		mm	(inch)	Length	419	(16.50)	Width	148	(5.83)	Height	98	(3.86)	Holding Cap	85	(3.35)	<p>8 Systems Order No. 5CF1540-20-08H</p>  <table border="1"> <thead> <tr> <th></th> <th>mm</th> <th>(inch)</th> </tr> </thead> <tbody> <tr> <td>Length</td> <td>398</td> <td>(15.67)</td> </tr> <tr> <td>Width</td> <td>198</td> <td>(7.80)</td> </tr> <tr> <td>Height</td> <td>81</td> <td>(3.19)</td> </tr> <tr> <td>Holding Cap</td> <td>85</td> <td>(3.35)</td> </tr> </tbody> </table>		mm	(inch)	Length	398	(15.67)	Width	198	(7.80)	Height	81	(3.19)	Holding Cap	85	(3.35)
	mm	(inch)																														
Length	419	(16.50)																														
Width	148	(5.83)																														
Height	98	(3.86)																														
Holding Cap	85	(3.35)																														
	mm	(inch)																														
Length	398	(15.67)																														
Width	198	(7.80)																														
Height	81	(3.19)																														
Holding Cap	85	(3.35)																														
1550	<p>2 Systems Order No. 5CF1550-20-02V</p>  <table border="1"> <thead> <tr> <th></th> <th>mm</th> <th>(inch)</th> </tr> </thead> <tbody> <tr> <td>Length</td> <td>498</td> <td>(19.61)</td> </tr> <tr> <td>Width</td> <td>148</td> <td>(5.83)</td> </tr> <tr> <td>Height</td> <td>98</td> <td>(3.86)</td> </tr> <tr> <td>Holding Cap</td> <td>85</td> <td>(3.35)</td> </tr> </tbody> </table>		mm	(inch)	Length	498	(19.61)	Width	148	(5.83)	Height	98	(3.86)	Holding Cap	85	(3.35)	<p>10 Systems Order No. 5CF1550-20-10H</p>  <table border="1"> <thead> <tr> <th></th> <th>mm</th> <th>(inch)</th> </tr> </thead> <tbody> <tr> <td>Length</td> <td>498</td> <td>(19.61)</td> </tr> <tr> <td>Width</td> <td>198</td> <td>(7.80)</td> </tr> <tr> <td>Height</td> <td>81</td> <td>(3.19)</td> </tr> <tr> <td>Holding Cap</td> <td>85</td> <td>(3.35)</td> </tr> </tbody> </table>		mm	(inch)	Length	498	(19.61)	Width	198	(7.80)	Height	81	(3.19)	Holding Cap	85	(3.35)
	mm	(inch)																														
Length	498	(19.61)																														
Width	148	(5.83)																														
Height	98	(3.86)																														
Holding Cap	85	(3.35)																														
	mm	(inch)																														
Length	498	(19.61)																														
Width	198	(7.80)																														
Height	81	(3.19)																														
Holding Cap	85	(3.35)																														

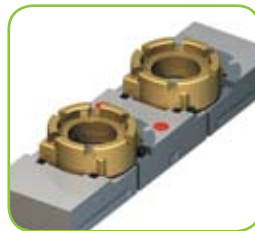
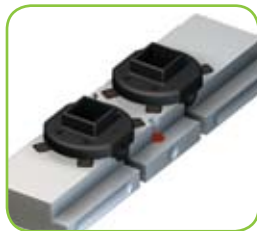

GRIPPERS

	Gripper #3	Gripper #4	Gripper #5	Gripper #6
Dimensions (Length x Width x Thickness)	9mm x 9mm x 3mm	12mm x 12mm x 4.6mm	15mm x 15mm x 5mm	19mm x 19mm x 6mm
Chick Gripper Plain	005-2531	005-2541	005-2551	005-2561
Chick Gripper Serrated	005-2532	005-2542	005-2552	005-2562

ACCESSORIES

QWIK-LOKS MOUNTING

Qwik-Loks can mount either to CHICK's Foundation or to your T-Slotted table.

FOUNDATION

A

Complete fixturing change over in minutes. Take advantage of CHICK's Round and Diamond Pin Set for location and then bolt the system in place.

T-SLOTTED TABLE

B

Select the appropriate Locating Keys and a set of Toe Clamps to mount to the machine's T-Slotted table.

NESTED SUBPLATES

C

The 50mm Qwik-Loks have an additional mounting option—The Nested Subplate—which gives the ability to mount five 50mm Qwik-Loks side by side.

Round and Diamond Pin Set MPIN12S

A



Round and Diamond Pin Sets are used to locate Qwik-Loks Systems (pgs. 9-10) quickly and accurately. *50mm systems require an adapter (# 081-0900).

Toe Clamps 005-0254

B¹



CHICK Toe Clamps (four per set) provide the quickest and most secure means of mounting a Qwik-Lok to a T-Slotted VMC table. Toe clamps are designed to be used with either 1/2-13 or M12 socket head cap screws.

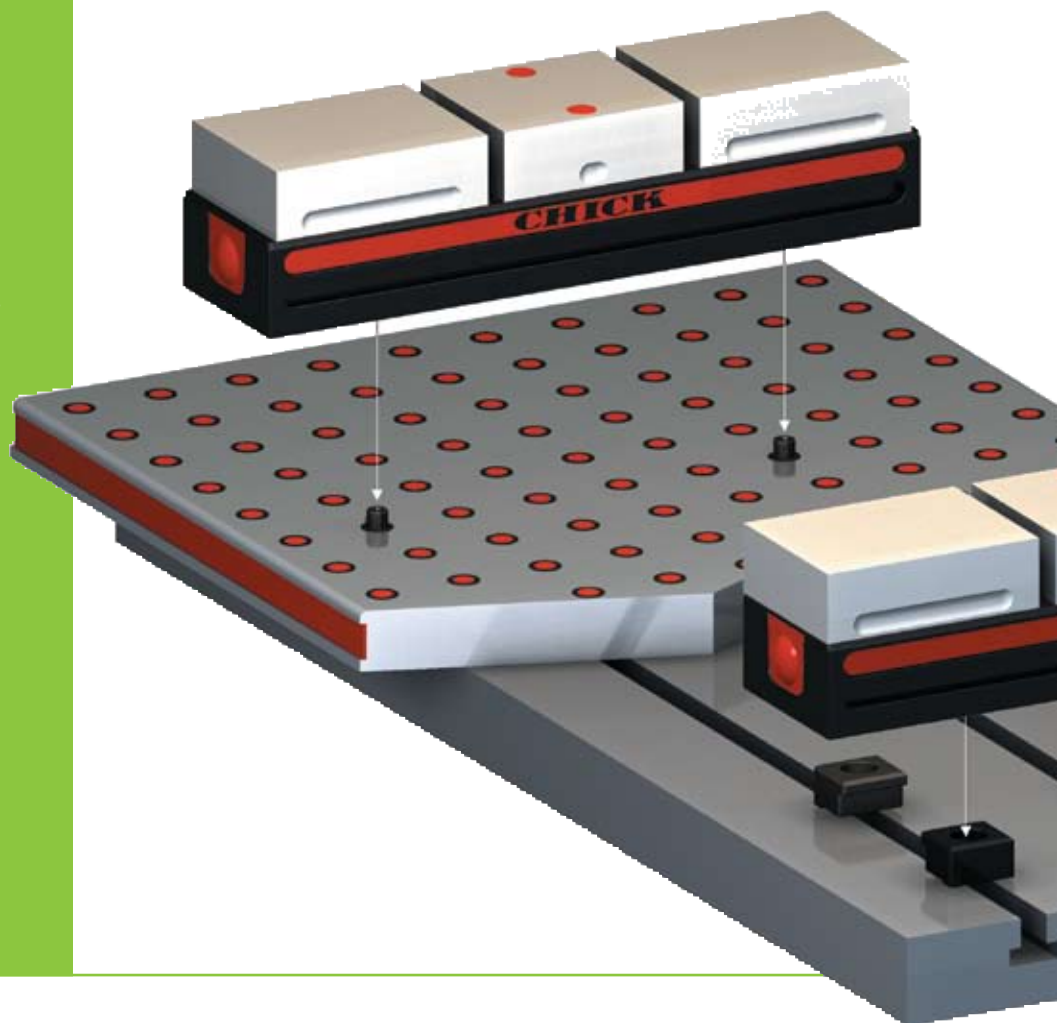

B²

Locating Keys Order #'s Below



Locating Keys (two keys per set) are used to provide positive location when mounting Qwik-Loks to T-Slotted VMC tables. These keys utilize a ball lock mechanism to fasten on to the underside of all Qwik-Lok bases.

Order No.	Width
MKE10	10mm
MKE12	12mm
MKE14 x 18	14 & 18mm
MKE16	16mm
MKE20	20mm
MKE500	.500"
MKE562	.562"
MKE625	.625"
MKE688	.688"
MKE750	.750"
MKE812	.812"

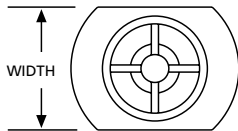

Nested Subplates

C

QwikChange™ five 50mm Qwik-Loks in minutes. Simply bolt the Qwik-Loks to the Subplate and mount the Subplate to either a CHICK Foundation or a T-Slotted table.

System Sizes

0520 and 0525

Order No.	083-2305		083-2505	
Dimensions	mm	(inch)	mm	(inch)
Length	250	(9.84)	250	(9.84)
Depth	200	(7.87)	250	(9.84)
Height	35	(1.38)	35	(1.38)

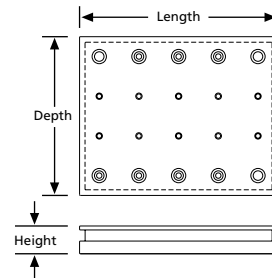



CHICK

Efficiency Through Workholding Innovation

500 Keystone Drive
Warrendale, PA 15086
Phone: 724-772-1644
1-800-332-4425
Fax: 724-772-1633
www.ChickWorkholding.com

SYS 5-00? (??M) 1/08 GACC