

Internal logistics for production sites

Handling systems to and from the warehouse: technology, infrastructures and fully integrated solutions for warehouse automation and cost reduction for the manufacturing industry.

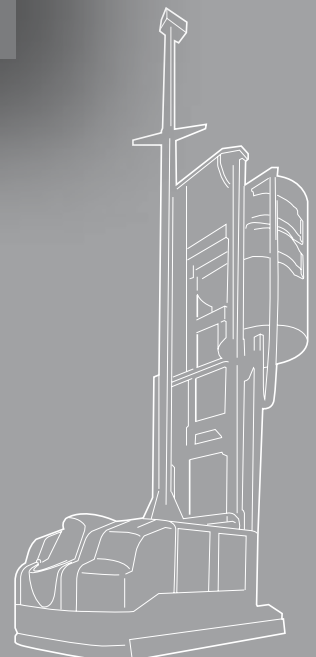

Text by Roland Guglielmetti, Gabriele Folli, Manuel Bolzoni

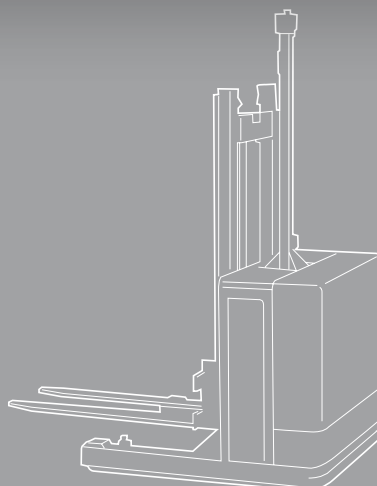
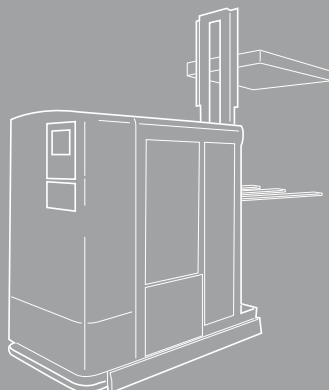

Machine series

OCME designs, manufactures and installs filling, packaging, palletising and handling machines for all the major mass consumer product manufacturing sectors. OCME machines are the result of decades of experience and are designed to become the backbone of our Customers' production division.

High and low level depalletisers	DORADO
	ANTARES
Roll-fed labeller	SAGITTA
Level filler for beverages	HYDRA
In-line and rotary volumetric fillers	LYNX
In-line and rotary weight fillers	LIBRA
Shrink-wrap and tray-packers	VEGA
Wraparound packers	ALTAIR
Combined wraparound and shrink-wrap packers	GEMINI
High and low level palletisers with 90° infeed	PERSEUS
In-line high and low level palletisers	ORION
Robot palletisers	PEGASUS
Automated guided vehicles	AURIGA
Computerised control system	ALBATROS

Internal logistics for production sites

Handling systems to and from the warehouse: technology, infrastructures and fully integrated solutions for warehouse automation and cost reduction for the manufacturing industry.

Contents

Internal logistics systems: from operating requirement to opportunity for success	5
Logistics automation in production sites	6
Handling through automatic guided vehicles: comparing technologies	8
System logic and automated vehicles: Internal logistics as seen by OCME	10
Auriga: laser-guided shuttles according to OCME	14
Warehouse management	20
The Auriga series	22
On-site safety: an investment for the future	28
Auriga and the environmental impact	30



Aunga

1

ocme

Internal Logistics Systems: from operating requirement to opportunity for success

...[ed. note: in a competitive environment] the best result is obtained when each component of the group does what is best for him/herself and for the group.

John Nash (Bluefield, USA, 1928, Nobel Economy Prize in 1994)



Today, internal production logistics represent a real challenge for the manufacturing industry the world over. Over the last decades, the transition to automated, operator-free systems has seen the large majority of manufacturing plants equip their processing and packaging lines with automated systems in which the operator's tasks are limited merely to supervision and control. Now, this trend is also spreading to internal logistics. Upstream and downstream of the production process, automated handling of merchandise, pallets and raw materials by systems run through software packages that provide continuous monitoring of operating parameters and define the tasks to be assigned to each unit, is a growing reality.

Companies in almost all sectors of the consumer goods industry are experiencing a growing need to implement these types of systems. The reason for this is to be found in the vast variety of requirements that fully-integrated internal logistics systems are capable of satisfying.

First and foremost among these is safety in the workplace, as the use of operator-driven fork lift-trucks is one of the major causes of on-site accidents. Indeed, it must be noted that the work carried out by a traditional fork lift-truck operator entails a series of issues tied to physical and psychological stress factors to which the operator is subject, such as problems deriving from poor posture, accidents, sometimes serious, during manoeuvres and the risk of damaging objects.

Hence, safety is a key issue when it comes to choosing an integrated and automated logistics system, also in view of the considerable legal and economic implications of industrial accidents.

Another factor that must not be underestimated is cost reduction, achieved through a reduction in personnel required at the beginning and at the end of the production line.

Generally speaking, a fully-automated system guarantees an extremely rapid return on investment, with payback usually within three years, which in turn allows for a major economic and financial efficiency already over the medium term.

But that's not all; one must also bear in mind the importance of continuously monitoring the production process which, by automating a part of the normal production flow traditionally entrusted to human monitoring, allows for the complete traceability of production lots along the entire production chain and right up to mass distribution.

Software-controlled plants "invaded" by self-driven vehicles may paint a somewhat futuristic scenario; however, they are in fact a reality that has provided many companies with an appreciable opportunity to increase competitiveness.

The aim of implementing an integrated internal logistics system is complete management of handling operations to and from the warehouse, right up to product loading on lorries for haulage, without the need to use personnel resources (other than for supervision and control). Hence, suppliers of automated handling systems base their success on their capacity for system integration or on their capacity to foresee future requirements, to envision and anticipate possible criticalities and provide an open system that may be expanded without impact to the customer's software or structural framework.



Logistics automation in the manufacturing industry



The automation of beginning and end of line logistics must be evaluated in an integrated manner, in order to guarantee meeting the fundamental objectives. First among these aims is to improve the competitiveness of the corporate system. In addition to improving cost efficiency, an integrated management system may also enhance resource management in terms of both efficiency and speed of handling. This constantly growing need for flexibility is the reason for which integrated handling and logistics instruments strive to provide companies with a better picture of the stock-on-hand to optimise raw material use and storage. This page illustrates an ideal environment, wherein handling systems interact with the production division and with end of line machines, not only producing obvious advantages by replacing traditional lift trucks, but also recording all the information required for present and future warehouse management. In this sense, automated internal logistics systems provide companies with a significant competitive edge. Data tracking allows companies to meet market demands in terms of greater precision and quality control in product management, as well as providing a computer-stored information database on which to base projects and plans for future development.

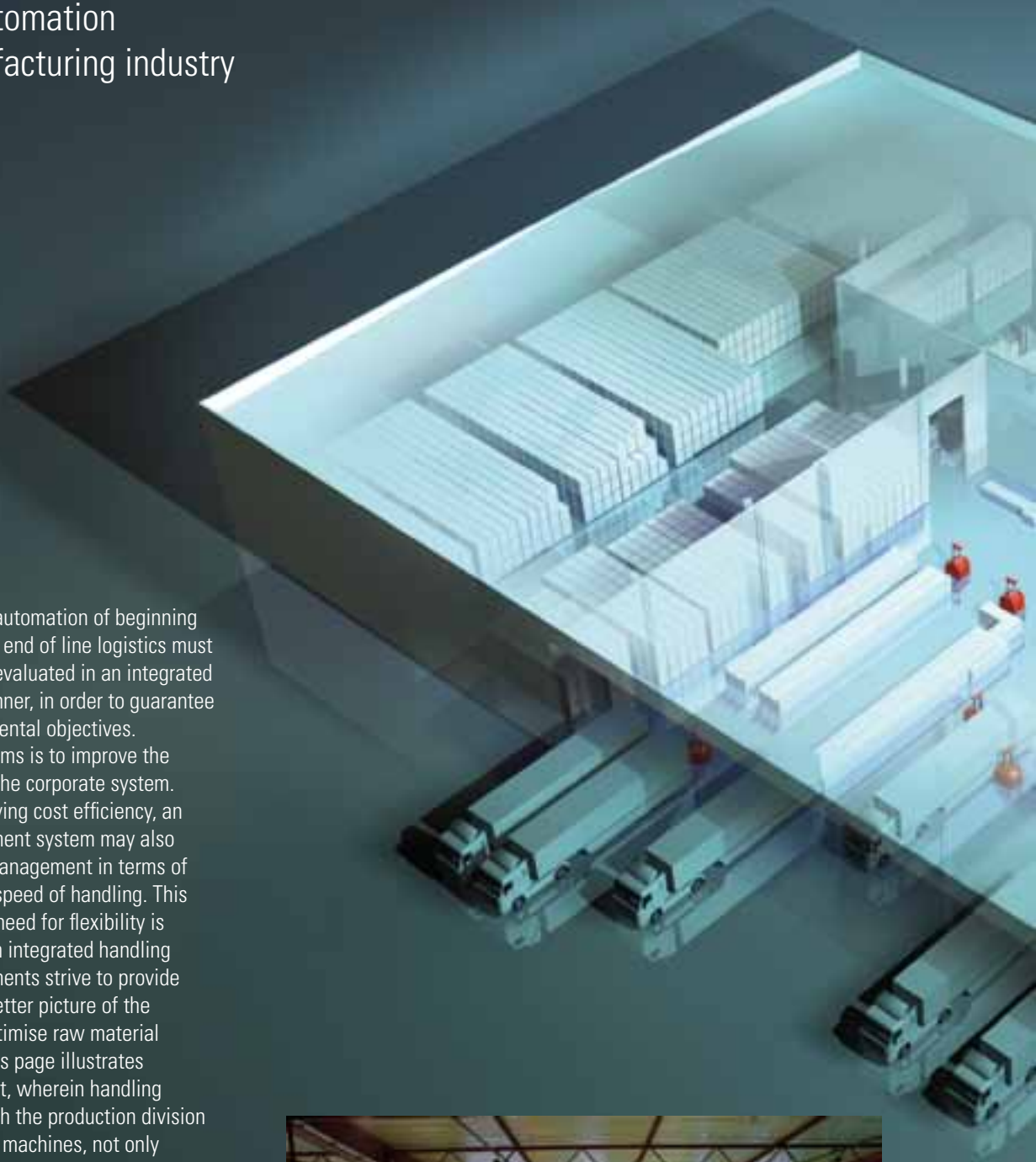

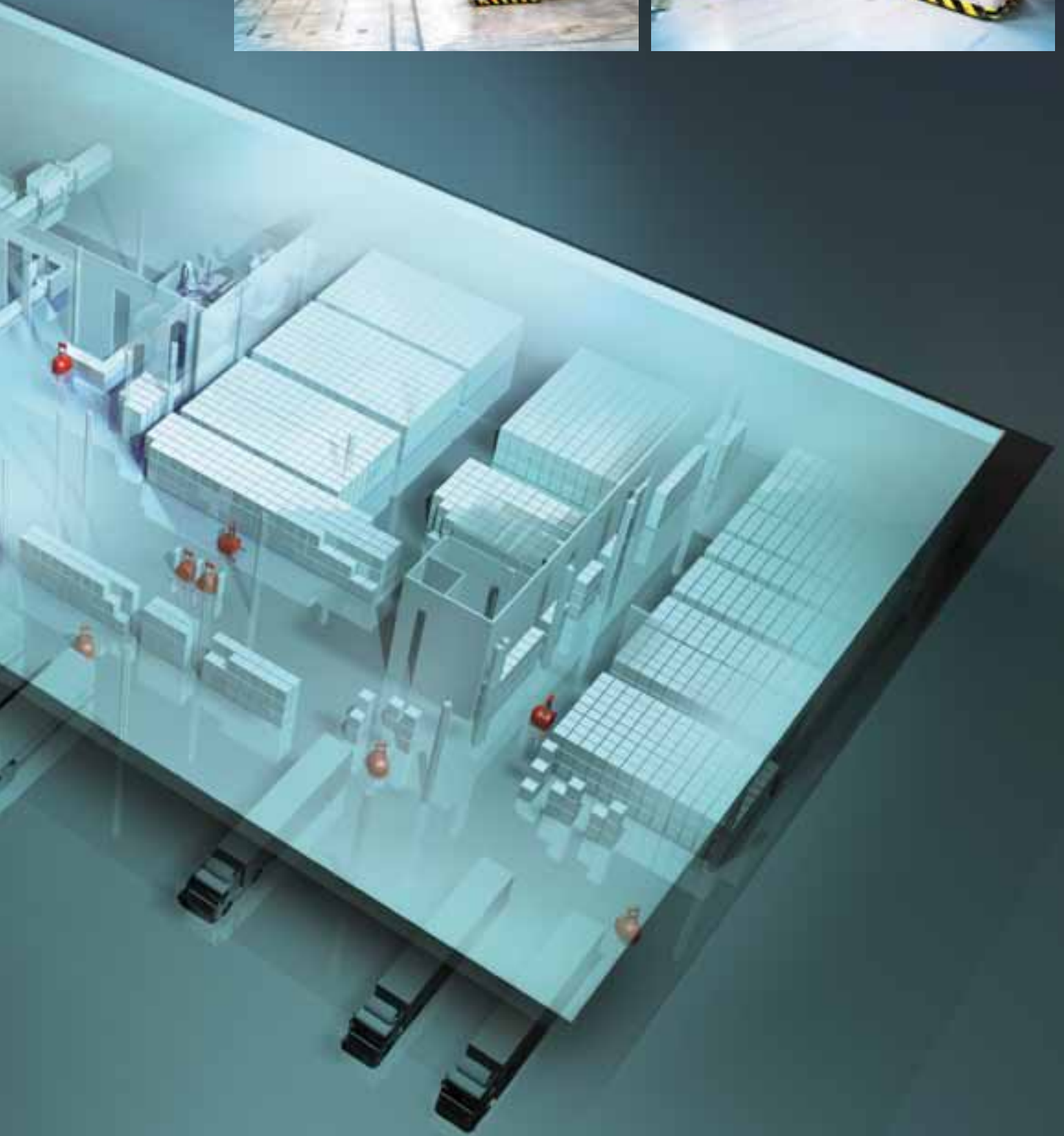

Figure 1
An example of an LGV
in a production plant.

Handling through automatic guided vehicles: comparing technologies

The term AGV (the acronym for Automated Guided Vehicle) is generally used to identify all vehicles that can move and perform specific tasks without being driven by an operator. Various types of AGVs are used in almost every merchandise sector of the manufacturing industry to move any type of product (usually on pallets). The functions that may be performed by an AGV are practically the same as those usually assigned to a fork truck with a driver. AGVs may operate using various types of AGV navigation technologies; the list provided below refers to the most commonly used systems in the industrial sector and does not take into consideration experimental technologies that are not yet operative.

Wire-guided vehicles

These vehicles follow a preset path defined by a series of electrical wires embedded in the plant floor. The vehicle determines its position thanks to sensing coils that detect the electromagnetic field of the “guide” wires. This type of technology has relatively contained initial costs and provides a good degree of precision of movement; however, all changes to vehicle routes, even small modifications, involve cutting slots in the plant floor. Furthermore, vehicles must move at a relatively slow speed in order to avoid losing contact with the “guide” wires, as the system is highly sensitive and reacts to even the slightest unevenness of the floor.

Magnet-guided vehicles

Magnet-guided vehicles follow routes that are created by magnets embedded in the floor at regular intervals. A series of linear sensors allows the vehicle to monitor its position along the magnetic grid every time that it passes near one of the magnets. However, the AGV moves from one magnet to another “blindly”, that is, without actually knowing exactly where it is; in fact, the AGV navigates following a route that is calculated based on the position of the last magnet detected. Like wire-guided vehicles, magnet-guided vehicles have the disadvantage of being dependent on structures anchored to the floor which, in the event of changes to vehicles routes, must be removed and repositioned. Precision of navigation is quite low, seeing as the vehicles can make course corrections only when they come into detection range of a magnet.

Magnet/Gyroscope-guided vehicles

A gyroscope mounted onboard magnet-guided vehicles improves the precision of navigation. The vehicle determines the direction in which it is moving by measuring the change of angle in the path between two adjacent magnets. Aside from the added precision of movement, gyroscope-driven vehicles have all the same disadvantages of magnet-driven vehicles.

Laser-guided vehicles (LGV)

Laser-guided vehicles guarantee precision, operating flexibility and speed of movement, thanks to a series of special features. The position of the vehicle is determined 8 times per second. The vehicle is equipped with a laser beam that can determine the position of the shuttle with a margin error of just a few millimetres, simply by scanning and reading reflective laser targets fitted on the walls of the working area, and then triangulating the position. LGV vehicles are free to move at relatively high speeds in that they are not anchored to structures embedded in the floor, and any changes to vehicle routes may be made simply by modifying the software. Laser-guided vehicles are generally less sensitive to uneven or rough floors.



Figure 2
Product pick-up
at shrink-wrapper outfeed.

Comparing Technologies

	Wire-guided	Magnetic	Gyroscopic	Laser-guided
Impact on existing site structures	-	=	=	+
Sensitivity to floor quality	=	-	-	+
Precision of movement	+	-	=	+
Speed of movement	-	-	=	+
Post installation modifications	-	-	-	+
Initial cost	+	+	=	-
Cost of vehicle maintenance	=	=	-	=
Cost of system maintenance	-	=	=	+
Continuous position control	+	-	=	+
Safety of movements	+	-	=	+
Smoothness of movements	+	-	=	+
Product stability	+	-	=	+

+ Positive **= Neutral** **- Negative**

System logic and automated vehicles: internal logistics as seen by OCME



OCME is a long-time player in the field of automated handling systems and internal logistics. The growth in this

sector, in terms of both sales and applied technologies, has gained increasing momentum in recent years, thanks to the development of laser-guided vehicles and to logistics control and integrated management technologies. In this field, OCME has decided to operate in an absolutely independent manner, without depending on external partners or third party technologies in general. OCME has pooled all the necessary know-how from specialists and engineers who are experts in this sector. Their experience and high level skills have allowed OCME to create a new and important Handling Business Unit, in record time and with innovative products, immediately gaining positive customer response.

The logistics projects were based on the desire to assert OCME as a full-service supplier for all automated handling, packaging, palletising and filler technology solutions.

It is no coincidence that the company motto, “moving ideas”, conveys the company vocation for dynamism and drive.

However, movement technology does not mean merely manufacturing good vehicles or good hardware in general. Understanding all real customer needs, foreseeing new scenarios for future development and organising a complex project capable of interacting with pre-existing systems and infrastructures requires considerable engineering know-how in various different fields. In this sense, OCME can rely on half a century's worth of competencies and experience, acquired in most major industries the world over.

The OCME production programme in the field of logistics and handling comprises:

- Integrated management and control systems
- Auriga LGV laser-guided shuttles
- track-vehicles
- conveyor lines

Cost comparison between traditional lift trucks and Auriga laser-guided systems

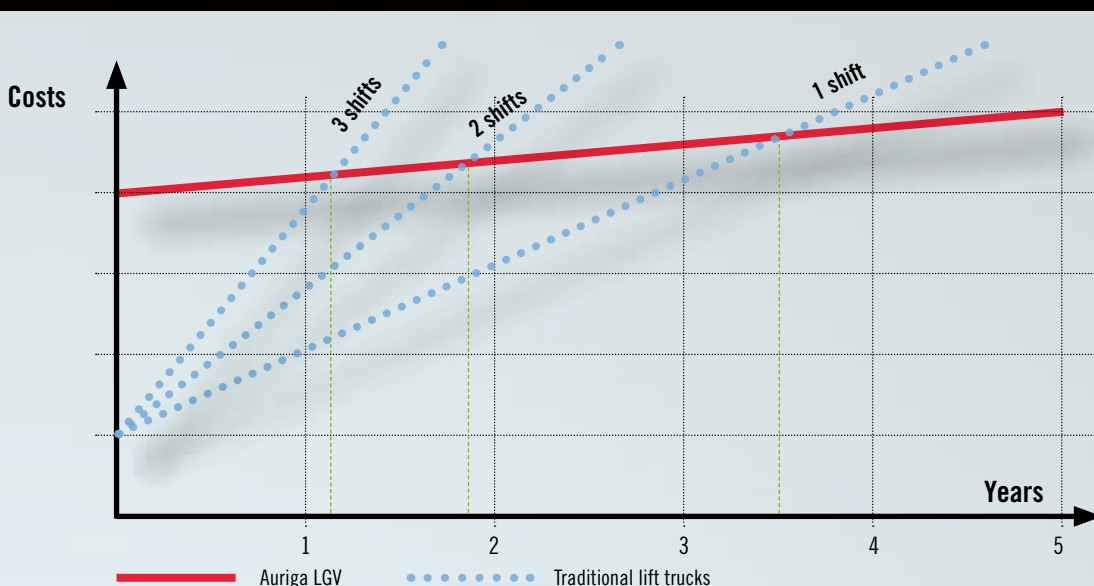

Note: calculations are based on average European cost of labour.



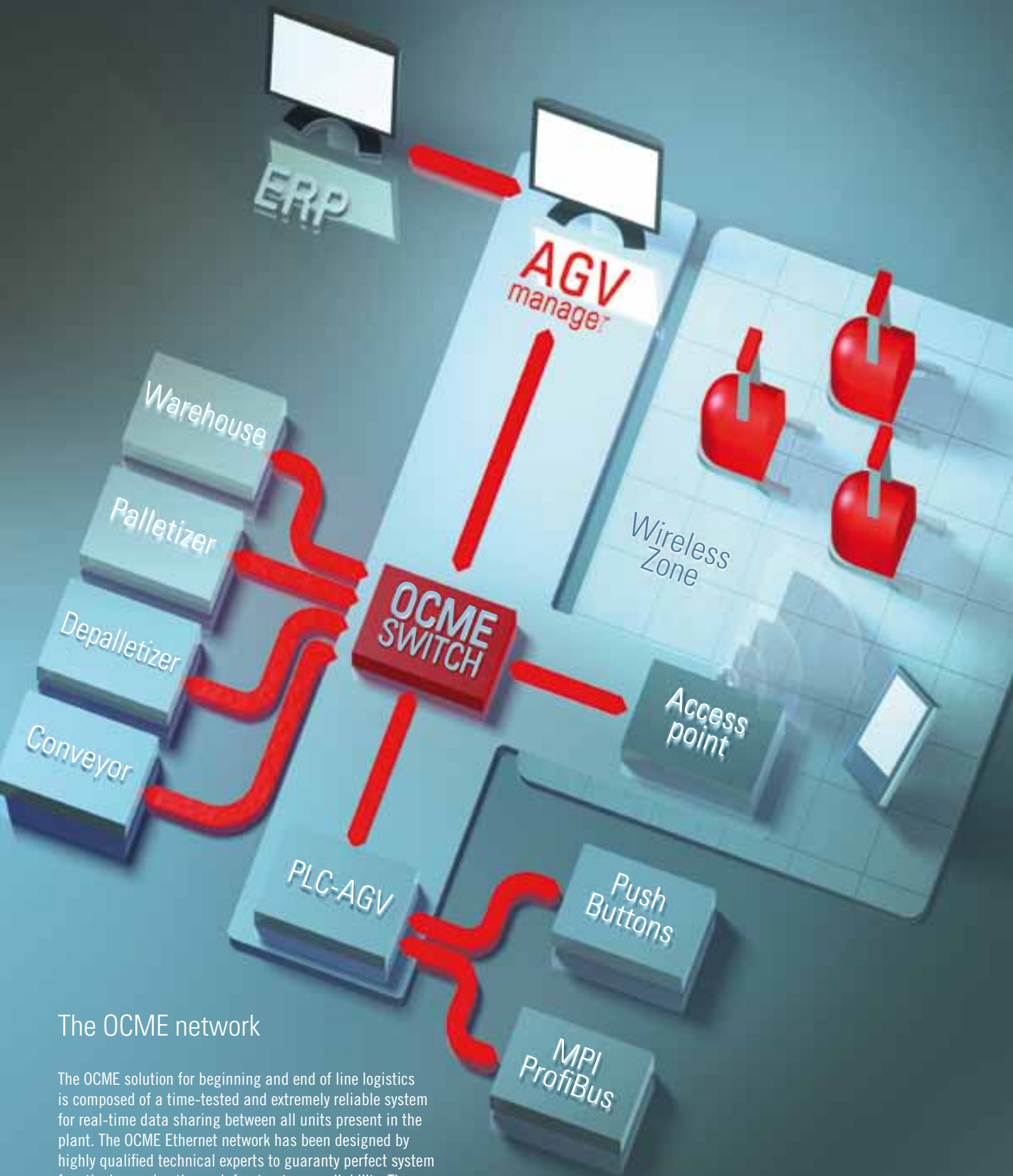

The OCME network

The OCME solution for beginning and end of line logistics is composed of a time-tested and extremely reliable system for real-time data sharing between all units present in the plant. The OCME Ethernet network has been designed by highly qualified technical experts to guaranty perfect system functioning and optimum infrastructure availability. The network, which is part hard-wired and part wireless, allows LGV vehicles to share data with the main traffic management system and simultaneously evaluate calls incoming from operators (by means of standard pocket terminals), palletisers, depalletisers or, in general, from any other system, regardless of the language or communication protocol used.



Target: Product Tracking

Certain key aspects of warehouse logistics have gained increasing importance in modern-day warehouse management, such as being able to track products and monitor the entire handling process.

As regards the first aspect, product tracking, OCME systems keep a record of every pallet handled in order to be able to reconstruct its background, route and any other information deemed necessary. This means knowing the exact composition of the warehouse at all times, thereby altogether eliminating the need for inventory-taking. This integrated approach to product tracking also guarantees the efficient rotation of all consumables, eliminates product loss and allows for automatic warehouse reorganisation to optimise the use of available space.

Such a perfect tracking system becomes a system that is extremely easy to monitor, and the efficiency of which can be both measured and optimised. Every point, every unit, every machine is analysed by the system to pinpoint weaknesses that may compromise the overall efficiency of the production line. This also means having up-to-date production statistics for any given line or product. Thanks to shipping reports, operators no longer need to fill out shipping notes.

Figure 3
Simulation software graphic interface.

Figure 6
Wireless PDA for remote access to the control system.



The OCME system: the supervisor

The heart and the brains of the OCME system are housed in the control system (AGV Manager). This system can be interconnected with all other company systems such as PC, PLC, databases, and ERP systems, and its function is to define, monitor, foresee and file all the information pertaining to logistics system instruments and machines, particularly as regards Auriga laser-guided shuttles.

The control system manages and prioritises all mission requests and defines the criteria for dynamic LGV allocation. A mission request may also be assigned to specific vehicles in manual mode. By means of a completely visual interface, the system displays a synoptic description of the plant, showing the location of every shuttle, and the respective loads. The status of every vehicle may be displayed in order to verify operating parameters.

Traffic Manager

The OCME system traffic manager is the process that manages all communications to and from laser-guided vehicles. This process takes place via radio through regular, standard wireless networks on the TCP/IP protocol. The traffic manager can simultaneously handle a fleet of 99 vehicles. One of the specific tasks of this system is to define precedence, tasks and stoppages (idle time), for every single vehicle.

Figure 4
Supervision system.

Figure 7
Each vehicle has a triple-axis extension-fitted joystick that allows for extremely easy manual manoeuvring.

Simulation software

Every logistics integration project undergoes pre-evaluation and analysis even before reaching the operative stage.

Thanks to leading-edge software entirely developed by OCME, all requirements and critical points of the new system can be foreseen precisely, based on a given set of variables.

The simulation is operated through a graphic interface that displays a plant layout in which the vehicles move and behave just as they would in reality.

In this way, work loads and the precise fleet size may be defined in advance. This service is particularly important in that it provides a configuration of the logistics system that basically corresponds to customer requirements and allows trouble-shooting potential over-loads or weaknesses in advance so as to be able to intervene before the problem actually materialises on the plant floor.

Figure 5
Electrical panel with access point to the control system.

Figure 8
Video screen on-board the vehicle.



5



6



7

User Interface

The operator may interface with the LGV system in five ways:

- **Push-button panels**

Used to transmit simple information such as cell reset, access-denial to a given area for vehicles, a simple evacuation call, etc...

Push-button panels may be hard-wired directly to the LGV system electrical panel or connected to the OCME Wireless network.

- **PAD**

These devices allow for direct operator interface with the AGV Manager from any location and continuous and dynamic data exchange.

The status of all the machines managed by the LGV system may be recalled at any time.

All PADs are connected to the OCME Wireless network and may be equipped with a Barcode Reader.

- **Display**

Different types of Displays, in various sizes, on which the AGV Manager transmits useful information to operators, such as, for example, tripped alarms, destination bay for incoming trucks and any data that may simplify or reduce operator work load.

- **On-board Video Screen**

Every vehicle is equipped with an LCD video to allow the operator to visualise the vehicle status and alarms, as required, allowing for fast and efficient problem-solving.

All alarms are also signalled to the AGV Manager and recorded and may be visualised or consulted as required.

- **Printers**

If necessary, the AGV Manager may also manage printers, to print out production statistics, shipping notes or any other information that may be required.



8

Scheduled Maintenance and Helpdesk contracts



Scheduled vehicle maintenance is an important tool to ensure constant system availability, efficiency and safety over time. OCME proposes a modular and flexible servicing schedule composed of one yearly inspection, one or more yearly



maintenance appointments and a customer Helpdesk service. The aim of this service is to achieve maximum system availability, in-depth control of the vehicles including an analysis of the effective conditions, a precise



knowledge of the degree of component wear, a reduction of vehicle idle time, providing quick servicing to resolve easy problems thanks to the remote control systems, and cost savings on spare parts.

Auriga: laser-guided vehicles according to OCME



f all available navigation technologies, laser-guided navigation is both the easiest to install and the one that provides greatest flexibility of operation. Hence, OCME has chosen this solution to provide Auriga with a highly reliable drive and route correction system. Laser-guided navigation uses special reflective targets fitted to the walls of the shuttle working area, to provide a reference grid for shuttle orientation and steering. In fact, this type of system does not require the installation of any fixed or movable structures on the plant floor.

Changes to be made to the layout of the bay do not entail any site modifications, but simply require adjustments to the management software; indeed, the vehicles are designed to accept new routes and orders originating from the control system. Unlike other, less flexible navigation systems, automatic laser-guided shuttles can auto-determine the best route to follow to complete a given mission and are aware of the position of all other vehicles in the fleet, so as to avoid collisions. The numerous sensors onboard the shuttle and the system's unique management software logic enable the shuttle to steer clear of any obstacles present in the operating zone.





Figure 9
Auriga 15 for semi-automated
warehouse.

10



11



12



13



Wheel motor

The wheel motor is the vehicle's traction and steering device. The precision of movement and the amount of servicing required for shuttle operation depend on the quality of this component. Auriga vehicles are low-maintenance vehicles in that both the steering and traction drive systems run on alternating current (thereby eliminating the need for maintenance to replace the brushes typical of continuous current motors). The unique design of the wheel motor guarantees maximum precision of movement, as the steering motor is assembled directly on the rotation wheel and the encoder that controls vehicle orientation is mounted directly on the wheel motor's axis of rotation.

Telescopic Laser

If required, Auriga vehicles may be equipped with an automatic laser raising device. This solution allows raising the sensor up to a height of about 6.5 metres (over 21') in order to properly detect the reflectors where there are shelves or other obstacles on the ground. Simultaneously, the vehicle may cross doorways or passages that require the laser to be lowered.

Figure 10
Wheel motor.

Figure 11
Hydraulic control unit.

Figure 12
Vertical wheel motor.

Figure 13
Island for automatic
battery change.



Figure 14
Battery exchange station.

Figure 15
Motorised fork lifting system with helical screw (does not require a hydraulic control unit).

Figure 16
Telescopic laser.

Vehicle Batteries

Auriga vehicles may be fitted with one of three types of batteries, to be chosen based on system characteristics, the charge requirements and the vehicle maintenance management needs. The choice of which recharging system to adopt is fundamental in terms of deciding the entity of the system: efficiency, recharging times and degree of automation are all important factors to be considered in a global assessment of the entire system. Below are two tables that may be of use in making the right decision, based on production requirements.

Battery Type	Liquid lead-acid	Gel lead-acid	X FC-Flex
Guaranteed work yield	8/10 hours	8/10 hours	8/10 hours
Average service life	5/6 years	4/5 years	3/4 years
Maintenance	Water every 2/3 months	Unnecessary	Unnecessary
Emissions	Frees vapour during recharge	None	None
Cost	=	+	+
Type of recharging	Manual, automatic or trickle charge	Manual or automatic	Manual, automatic or trickle charge

Recharging system	Manual	Automatic	Trickle charging
Operator time requirement	3/5 minutes	3/5 minutes	-
Vehicle idle time	0% (3/5 minutes every 8/10 hours)	0% (3/5 minutes every 8/10 hours)	20-25% inefficiency (vehicle stopped for recharging)
Operators required	1	0	0
Batteries required	2 (1 on board + 1 recharging)	2 (1 on board + 1 recharging)	1 (on board)

Battery exchange or recharging system

The aim of the battery exchange or recharging system is to guarantee maximum Auriga vehicle autonomy. There are three types of system available: recharging by opportunity, semi-automatic battery exchange or automatic battery exchange. Every vehicle is equipped with charge level indicators managed by a microprocessor that constantly communicates with the AGV Manager and immediately signals charge status and consequently if the battery requires recharging or exchange.

Recharging by opportunity. Particularly suited to sites where LGV use is not continuous; the system sends the vehicles to a recharging station during vehicle idle time.

Semi-automatic battery exchange. The AGV Manager sends vehicles that have a low battery to a battery exchange station and simultaneously warns an operator. Battery substitution generally takes between 3 and 5 minutes and does not require the use of lift-trucks or bridge cranes.

Automatic battery exchange. When the vehicle battery needs to be replaced, the AGV manager sends the vehicle to the battery exchange station, where the battery is exchanged in a fully automated manner. This solution is particularly suited to sites with a large number of vehicles.

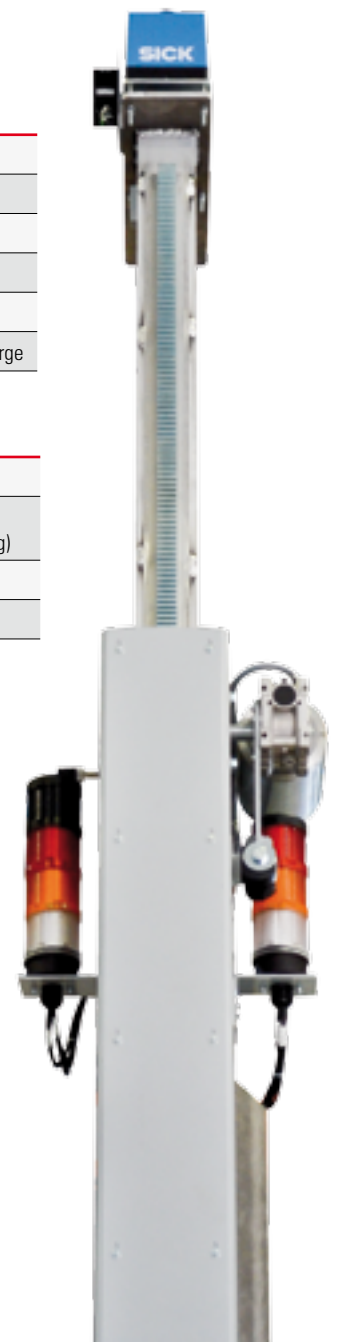



**Self-adjusting forks
Length-wise and width-wise**

Auriga vehicles may be equipped with a special device for automatic adjustment of fork length and width. This solution makes it possible to transport different sized products, letting the system adjust according to load size requirements. The mechanism is operated by solenoid valves connected to the main hydraulic system, controlled by limit-switch sensors and an encoder.

Variable-format forks

Some sites need vehicles that can transport one, two or three different-shaped pallets simultaneously. To meet this requirement, OCME can equip shuttles with a fork format automatic adjustment device that automatically manages the various format changes required for pallet handling.

Stabilisers

The vehicles may be equipped with lateral stabilisers to improve stability and loading capacity. Based on the model, added forks may even double rated shuttle loading capacity.

Door sensor

A special sensor equips Auriga vehicles to detect the opening of automatic doors where present in the plant.

Pressing load stabiliser

Both handling and lifting vehicles may be equipped with a press-device that stabilises the load from above.

Cylindrical reflectors

The use of cylinder-shaped reflectors guarantees improved detection on behalf of the shuttle laser beam from any position. This solution also reduces the total number of reflectors required and eliminates all navigating problems (Fig.19).

**Vehicles with conveyors
for ground handling**

Auriga vehicles may be used not only to lift loads in place of traditional lift trucks, but also as on-ground conveyor vehicles. The vehicles may be equipped with roller or any other type of conveyor system in order to provide an important logistic support for production lines and warehouses, which may thus take full advantage of the flexibility of the Auriga handling system.

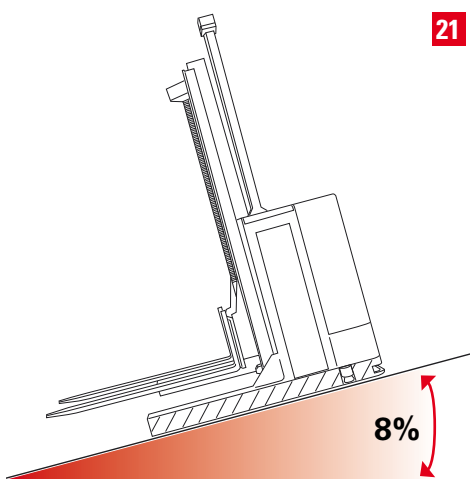

Figure 17
Vehicle with double, superimposed forks fitted and with telescopic laser equipped with a presser.

Figure 18
Fork opening and closing system with photoelectric cells on the tip of the forks to verify correct product pick-up.

Figure 20
On request, the emergency stop pushbuttons many be installed anywhere on the vehicle.

Commercially available electrical components

Auriga shuttles are designed to minimise difficulties the customer may encounter in finding spare parts. For this purpose, only commercially available electrical components are used. This feature also simplifies emergency repairs, which may thus be handled directly by the customer.

Commercially available mechanical components

The project for Auriga vehicles was rationalised also as far as the use of commercially available mechanical components is concerned. Some parts, such as for example the wheel motor, the lifting system (fork column) and the hydraulic control unit, may be purchased directly from suppliers of standard lift truck components.

Figure 21
Possibility of fitting the vehicle to travel on ramps with up to an 8% inclination.

Figures 22 and 23 (to the side)
Fork shuttles equipped to carry tissue or paper mother reels picked up from a horizontal position.

Figure 24 (to the side)
Clamp shuttles equipped to carry tissue or paper mother reels picked up from a vertical position for very high vertical warehouses.

22



24

23



Warehouse management (WMS)



Integrated warehouse management is achieved thanks to algorithms capable of making the correct decisions in terms of warehouse space optimisation. The AGV Manager guides the vehicles through specific missions based on the load that the vehicles must deposit or pick up, according to a series of parameters, such as for example:

- the code of the product to be handled,
- the presence of free areas or areas occupied by products with the same code,
- the storage date.

The following page illustrates a series of situations in which the AGV Manager must decide where to send the shuttles in order to properly optimise work loads. The examples refer to the handling of a given product, "E".

How does the system behave when it must deposit a product?

Example 1. Maximum space available

Starting situation: only two of the four rows have already been partially filled with products "A" and "B".

System behaviour: A new row is begun for product "E".

Example 2. High availability of space and presence of products of the same type on the platform

Starting situation: there are two rows assigned to products "A" and "D"; one row of product "E" has been started and there is still space available.

System behaviour: the row of "E" products is used until all the available space has been filled.

Example 3. High availability of space

Starting situation: the product "E" occupies one entire row and the system may use either a row that already contains one product "A" or a row containing both products "D" and "E".

System behaviour: The row containing one product "E" is begun.

Example 4. Choice based on storage date

Starting situation: product "E" is already present and occupies an entire row; two rows are available, but neither of these contains product "E"; the two available rows contain products with different storage dates.

System behaviour: product "E" is deposited in the row containing the product that has been stored for the longest time.

How does the system behave when it must pick up a product?

Example 5. Choice between four possibilities

Starting situation: product "E" is available at the beginning of four rows.

System behaviour: the presence of a row where product "E" blocks "D" products makes the system decide to free this mixed row first.

Example 6. Choice based on storage date

Starting situation: product "E" is available at the beginning of three rows that differ one from the other by storage date.

System behaviour: the product with the oldest storage date is picked up first.

Example 7. Recovery of a product not available at the beginning of a row

Starting situation: product "E" is available, but other products that block access to product "E" must be repositioned.

System behaviour: the system repositions the products according to recovery algorithms until the first product "E" becomes accessible for pick up.

Example 8. Row compaction (or de-compaction by inverse movements)

Starting situation: The operator wishes to compact one or more rows to reclaim empty row space in the warehouse.

System behaviour: first the two "B" products are moved together, followed by the "A" product. This frees two rows.



Platform organisation algorithms

Example 1

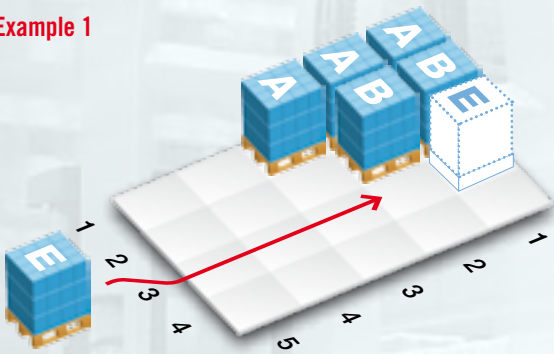

Example 5

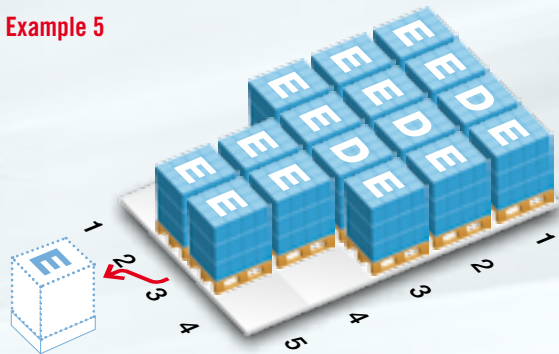

Example 2

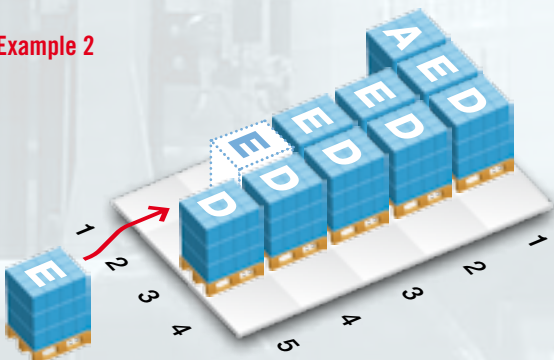

Example 6

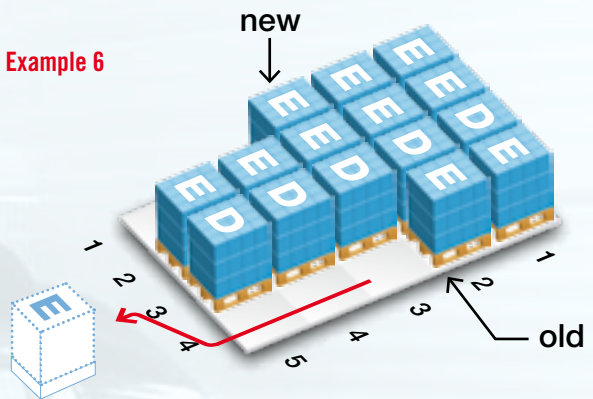

Example 3

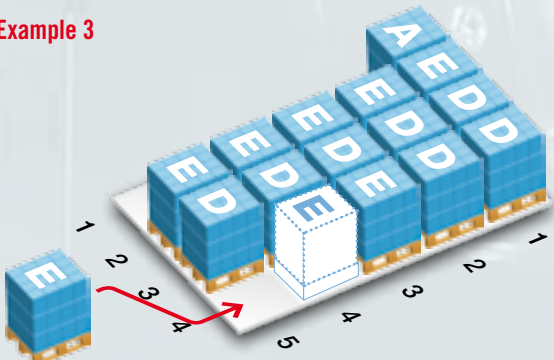

Example 7

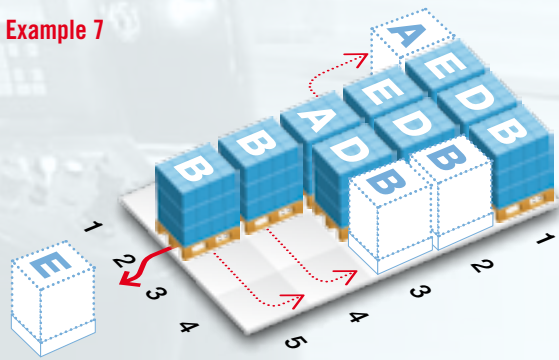

Example 4

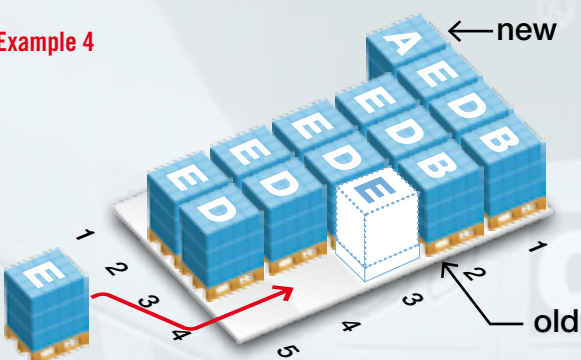

Example 8

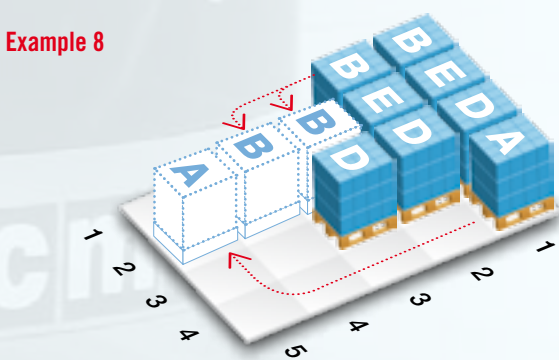

The Auriga Series

The Auriga series of laser-guided vehicles is composed of three standard models with a loading capacity of between 1,500 and 4,500 Kg. Two main variations of the model are also available: a lifting vehicle, which performs the same tasks as traditional lift trucks, and conveyor-equipped vehicles, mainly used for product transfer.

A series of optional features allow the creation of vehicles that may perfectly fulfill the specific requirements of any company, in terms of both loading capacity and versatility. Lifting vehicles may be provided with equipment suited to handle from one to up to eight pallets simultaneously. Forks may be short, long or telescopic, with fixed or adjustable format,





according to the type of load handled. Lateral stabilising devices may be mounted on standard models to increase loading capacity.

Conveyor-equipped vehicles may be provided with rollers, chains or belts, according to the specifications of the loads to be handled. Here again, the number of pallets that may be handled varies from one to eight, based on the configuration chosen.

Vehicles may be lateral-load or rear-load shuttles; both loading systems deliver the maximum precision and optimum safety standards guaranteed by OCME Auriga systems. All Auriga vehicles can be equipped with the following features: telescopic laser, load press-stabilisers, additional load weight control and safety packages.

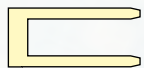
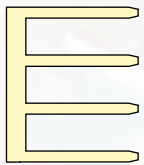
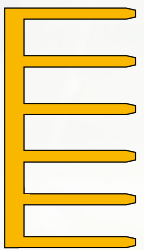
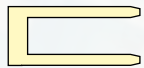
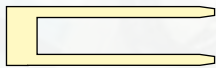

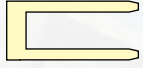
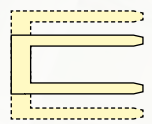
Auriga series vehicles and main optional features

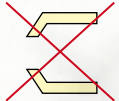
Lifting vehicles	
2 Number of pairs	<div style="display: flex; justify-content: space-around; align-items: center;"> <div style="text-align: center;"> <p>A</p>  <p>One pair</p> </div> <div style="text-align: center;"> <p>B</p>  <p>Two pairs</p> </div> <div style="text-align: center;"> <p>C</p>  <p>Three pairs</p> </div> </div>
3 Lengths	<div style="display: flex; justify-content: space-around; align-items: center;"> <div style="text-align: center;"> <p>A</p>  <p>Short</p> </div> <div style="text-align: center;"> <p>B</p>  <p>Long</p> </div> <div style="text-align: center;"> <p>C</p>  <p>Telescopic</p> </div> </div>
4 Opening / Closing	<div style="display: flex; justify-content: space-around; align-items: center;"> <div style="text-align: center;"> <p>A</p>  <p>Fixed</p> </div> <div style="text-align: center;"> <p>B</p>  <p>Adjustable width</p> </div> </div>
5 Stabilisers	<div style="display: flex; justify-content: space-around; align-items: center;"> <div style="text-align: center;"> <p>A</p>  <p>With stabilisers</p> </div> <div style="text-align: center;"> <p>B</p>  <p>Without stabilisers</p> </div> </div>



Example 1. Auriga 45 + **2C** + **3A** + **4B** + **5B**

4500 Kg Three pairs Short Adj. Width Without stabilisers

Example 2. Auriga 15 + **2A** + **3A** + **4A** + **5B**

1500 Kg Una coppia Short Fisse

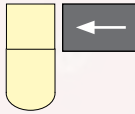

Conveyor-equipped vehicles	
2 Type of conveyor	<div style="display: flex; justify-content: space-between; align-items: center;"> <div style="text-align: center;"> <p>A Rollers</p> </div> <div style="text-align: center;"> <p>B Chains</p> </div> <div style="text-align: center;"> <p>C Belts</p> </div> </div>
3 Number of conveyors	From 1 to 8
4 Type of load system	<div style="display: flex; justify-content: space-around; align-items: center;"> <div style="text-align: center;"> <p>A</p>  </div> <div style="text-align: center;"> <p>B</p>  </div> </div>

Example 3. Auriga 15* + **2B** + **32** + **4A**

1500 Kg Chains Rear-loading Side-loading

*Version with presser



Product range and indicative technical data



			10	15	20
Load capacity	Barycenter 600	Kg	1000	1500	2000
Weights	Vehicle weight with battery	Kg	3000	3500	5500
Maximum ground pressure (Battery included with maximum load)"		Kg/cm ²	50	60	55
Wheel motor	Type		Integrated	Integrated	Vertical
	Diameter	mm	353	353	406
	Width	mm	123	123	178
	Power of traction motor	kW	4,5	4,5	6,5
	Power of steering motor	kW	0,8	0,8	1,4
Free wheels	Diameter	mm	200	200	250
	Width	mm	70	70	100
Sizes Fork 1200	Width	(b2) mm	1192	1192	1585
	Length	(l7) mm	2900	3075	3190
	Height	(h6) mm	1810	1924	1860
	Height of Forks	(h3) mm	6000	6000	6000
Performance	Travel speed	m/min	100	100	100
	Fork lifting speed	cm/sec	20 / 30	20 / 30	20 / 30
	Acceleration	m/sec ²	0,8	0,8	0,8
	Precision	mm	5	5	5
Power recovery	While slowing down		✓	✓	✓
	While forks are moving down		✓	✓	✓
Tilting			Optional	Optional	Optional
Batteries (Voltage-Power-Weight)	Liquid lead-acid	V-Ah-Kg	48 / 310 / 525	48 / 465 / 800	48 / 620 / 955
	Gel lead-acid	V-Ah-Kg	48 / 280 / 555	48 / 420 / 810	48 / 620 / 955
	X FC-Flex	V-Ah-Kg	48 / 316 / 510	48 / 316 / 510	48 / 316 / 510

Note: Technical data to be reconfirmed by our technical department.

Sizes and space requirements

Fork length: 1200

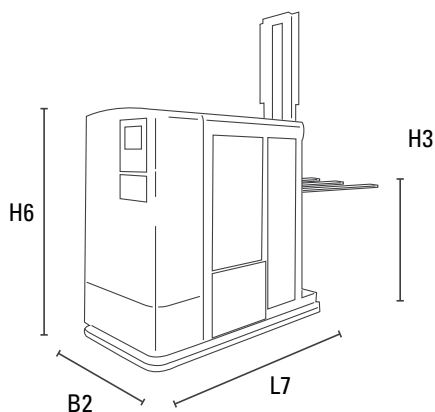

Easily accessible electrical panel.



30	45	25Z	40Z	60Z
3000	45000	2500	4000	6000
5500	6000	3000	3500	4000
55	55	55	55	55
Vertical	Vertical	Integrated	Vertical	Vertical
406	406	406	406	406
178	178	178	178	178
6,5	6,5	6,5	6,5	6,5
1,4	1,4	1,4	1,4	1,4
300	300	250	300	300
125	125Y	100	125	125
1585	1585	-	-	-
3440	3590	-	-	-
1860	1860	-	-	-
6000	6000	6000	6000	6000
100	100	100	100	100
20 / 30	20 / 30	20 / 30	20 / 30	20 / 30
0,8	0,8	0,8	0,8	0,8
5	5	5	5	5
✓	✓	✓	✓	✓
✓	✓	✓	✓	✓
Optional	Optional	Optional	Optional	Optional
48 / 620 / 955	48 / 875 / 1100	48 / 465 / 770	48 / 620 / 955	48 / 620 / 955
48 / 620 / 955	48 / 875 / 1100	48 / 420 / 850	48 / 620 / 955	48 / 620 / 955
*	*	48 / 316 / 510	*	*

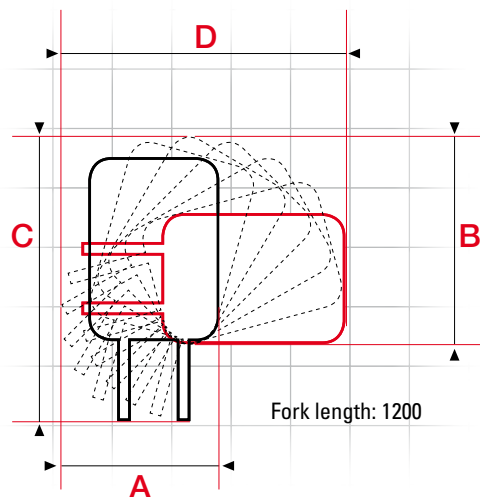

Indicative manoeuvring spaces for standard models

	10	15	20	30	45
A	2020	2020	2314	2315	2318
B	2121	2213	2601	2827	2966
C	3468	3533	3731	3948	4088
D	3491	3574	3798	4053	4200

The table specifies the manoeuvring space requirements expressed in millimetres for each model of the Auriga series.

Auriga

Vehicle mod **Auriga 25 Z**
with electrically powered forks

Vehicle mod **Auriga 15**
with split forks for simultaneous pick-up of
empty and full pallets, equipped with
stabiliser presser and telescopic laser

Vehicle mod **Auriga 15**
with electrically powered forks

Vehicle mod **Auriga 15**
with chain conveyor and
stabiliser presser

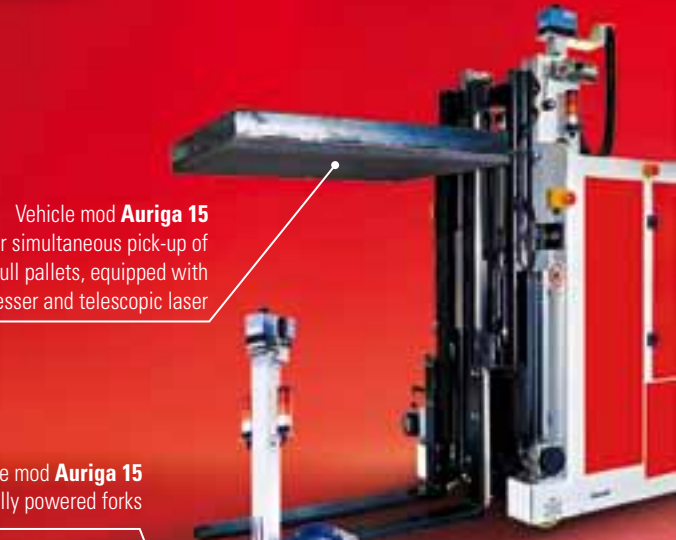

Maximum versatility and extremely customisable

Vehicle mod **Auriga 45**
with vertical reel picking clamp

Vehicle mod **Auriga 25 Z**
with forks for horizontal reels

Vehicle mod **Auriga 15**
with hydraulically powered forks

Vehicle mod **Auriga 15**
with belt conveyor and side guides



On-site safety: an investment for the future

The greater safety deriving from the use of an automated handling system is, in itself, sufficient reason to decide to implement such a system. Recent studies carried out in various countries speak of an enormity of serious injuries and deaths caused by or correlated to the use of traditional lift trucks. A study conducted in the United States

by the government agency OSHA (Occupational Safety & Health Administration) in 2006 reports that every year 96,700 workers are victims of accidents involving lift-trucks. Of these, 34,900 are classified serious accidents and 85 workers died as a result of the accident event. Statistics also report cases of fatal accidents occurring

during vehicle recharging. Here again, new-generation self-driven shuttles are programmed for automatic battery exchange or recharging and hence do not require operator intervention.

In addition to a clear ethical obligation to safeguard safety in the workplace, implementing automated handling systems may play a key role in the event of a limited and precise recall of non conformant products from the market.

Another aspect that should not be underestimated is that lift-truck transit zones are extremely dangerous for workers in those areas. Moreover, vehicle drivers may be called upon to work in injurious environments, such as inside refrigeration cells or in areas exposed to potentially noxious substances. In all such cases, machines, more precisely automatic guided shuttles, may perform the same tasks, often more efficiently, while guaranteeing maximum safety and significant risk reduction.



Figure 26
Series of sensors to detect suspended loads.

Statistics for accidents involving lift-trucks

Accidents caused by lift-trucks in the United States in 2006: **96.700** of which **34.900** classified serious, **61.800** classified of moderate entity, **85** deaths.

Causes:

- tipping
- collision with walls or surfaces
- collision between two vehicles
- being run over by a vehicle
- materials falling off lift-truck
- personnel falling off truck platform or forks

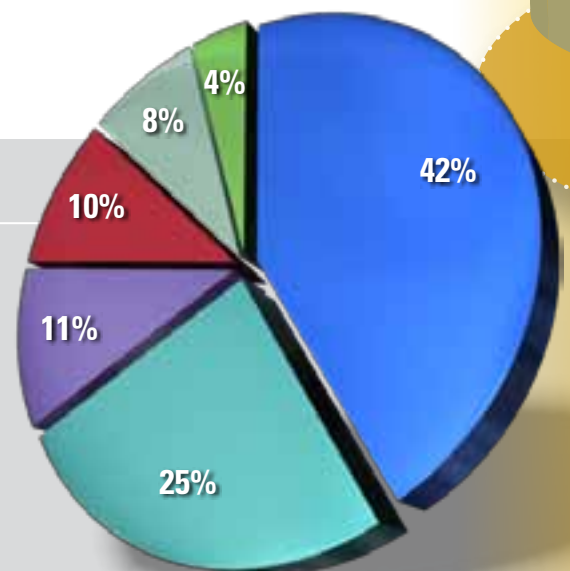

All devices are controlled by a certified safety PLC.

Active safety devices installed on Auriga shuttles

Door open sensor
Verifies if the doors in the site are open

Suspended load sensors

Photoelectric cell on the forks to verify correct load pick-up

Front Sick sensor for suspended loads

Rear Sick sensor

Lateral Sick sensor

Side bumper

Emergency mushroom push-button



Auriga and the environmental impact



Nowadays, companies can no longer ignore the significant environmental impact of their business activities. Although this is partly a purely ethical issue, it also has some important commercial implications. A growing number of consumers choose companies that focus on environmental safeguarding and respect. Also, it is important to bear in mind that a rational use of raw materials and sensible energy consumption policies are often associated to immediate cost reduction. Various aspects of the Auriga environmental respect programme take into account the strong implications of environment-friendly work policies. The vehicles are electrically driven and therefore do not (at least directly) release CO₂ or other gasses into the atmosphere. Furthermore,

the customer can choose between the types of battery mounted in the vehicle, based on the degree of "environmental compatibility" desired. For years now, OCME has been committed to environmental protection through the OCME WorldCare programme, a corporate programme aimed at environmental education and pro-active environment-friendly policies, such as differentiated waste collection, intelligent energy consumption and sensible use of raw materials in general. The principles of the programme aim at increasing the awareness of engineers and design experts to issues regarding safeguarding the environment and limiting the use of natural resources. The objective is to create a new class of systems wherein performance and efficiency grow alongside the capacity to ensure environmentally sustainable development.



WorldCare
Corporate environmental respect programme

All the OCME technologies dedicated to your sector

One of the characteristics for which OCME is renowned for in the market is the company's flexible approach to customer needs. We believe that each sector must be followed with specific care, because each has specific needs. For this reason, our staff of professionals is specialised in responding to the needs of every single customer, based on the unique characteristics of each sector.

Beer

Mineral water

Soft-drinks

Wines and spirits

Food

Edible oils

Tissue

Petrochemicals

Pharmaceuticals

Products for personal and home care

This technology is part of
the **IntegraPack.it Project**



OCME S.r.l.

Via del Popolo, 20/A
43122 Parma (Italy)
Phone +39-0521-275111
Fax +39-0521-272924
e-mail: info@ocme.it

OCME UK Ltd.

King John House, Kingsclere Park
Kingsclere - Newbury
Berkshire RG20 4SW (UK)
Phone: +44-1635-298171
Fax : +44-1635-297936
e-mail: sales@ocme.co.uk

OCME AMERICA CORPORATION

5300 N.W. 33rd Avenue, Suite 105
Ft. Lauderdale, FL 33309
Phone: 954-318-7446
Fax: 954-634-0238
e-mail: info@ocmeusa.com

OCME FRANCE

42 avenue Montaigne
75008 Paris
Phone: +33 (0) 6 27.89.36.20
email: commercial@ocme.fr

OCME Packaging Equipment (Jiaxing)

No.289 Mu Yang Road,
Jiaxing Economic Development Zone,
314033 Jiaxing City,
Zhejiang Province, P.R.China
Phone: +86-573-83971680
Fax: +86-573-83971690
E-mail: info@ocme.cn

OCMEXICO Embalaje, S. de R.L. de C.V.

Homero 425 Torre "A" Desp. 102
Col. Chapultepec Morales
México D.F., CP 11570
Phone: +52-55 52542401 ext. 103
Fax: +52-55 52542401 ext. 106
e-mail: info@ocme.com.mx

OCME and internal logistics

Our mission, as suppliers of packaging technologies, is not only the installation of systems that provide solutions to immediate problems. Rather, we believe that our role is to supply a vision of the **future of internal warehouse logistics**, and create avant-garde solutions. At any rate, this is what we have been doing since 1954.

This document serves to present our experience and our vision of handling technologies based on Auriga laser-guided vehicles. Like all OCME products, the Auriga system and vehicles are designed for intensive work loads and to meet customer performance specifications.

Nowadays, companies in every sector of the manufacturing industry have a new opportunity to differentiate themselves and increase competitiveness: the automation of warehouse logistics. Many factors point to warehouse automation as a practically compulsory choice (product tracking, greater industrial safety, resource optimisation), but one in particular is of key importance: cost reduction.

