



High Security, Energy Efficient Windows & Doors





Home

is where our story begins...

Welcome

This guide has been designed to help you fully understand the numerous benefits included with the Tricept range of windows and doors.

Tricept products are manufactured in accordance with all government energy-saving regulations and are installed by a select network of approved retail organisations throughout the UK.











The success of the Tricept brand is largely down to the many features unique to Tricept that will enhance the appearance, security and energy-efficiency of your home.

The homes that inspire us are the ones that reflect our personalities... we all have different lifestyles, favourite colours and tastes. It's things like personal objects collected over the years, eye-catching wallpaper or a thrifty find that makes the essence of our home and everyone unique.

So we would like to show you that choosing windows and doors can be inspiring and that it is possible to design something that is not just functional but becomes as unique to you as your home is.

We hope this fresh approach will inspire you long after your project has been completed.

contents

Tricept Windows	Pg 4	
Window Energy Ratings	Pg 6	
Window Security & Style	Pg 8	
Tricept Finer Details	Pg 10	
Tricept Doors	Pg 12	
Door Security & Style	Pg 14	
Quality Assurance	Pg 16	
Tricept Approved Installers	Pg 18	
Alternative Window Styles	Pg 20	
Alternative Door Styles	Pg 22	



Tricept Windows

In order to cater for the diverse mix of property styles and consumer preferences, windows and doors are now available in a wide variety of styles and finishes.

Using a combination of top openers, side openers and fixed panes, the range of styles is vast so you are sure to find a design to suit your home.

Similarly, there is no reason to compromise when replacing an existing bay window. Using our versatile bay posts, any combination of windows can be assembled to achieve the correct angles.



FRESH

Outlook

Bow bays can also be replaced in the same way or you may even wish to add character to your home by replacing an existing flat casement window with a bow bay.

With regards to comfort and security, Tricept windows will provide peace of mind using advanced multi-point locks and weather-resistant seals ensuring there are no irritating and costly draughts.

And using the right combination of frame and glass, your new windows will not only be draught-proof, they will also be more energy-efficient and even help to keep exterior noise out so you can get that all important peaceful nights sleep.

With the rapid advancement in PVC-u technology, you will now be hard pressed to tell the difference between PVC-u products and their timber equivalents.

This provides you with a multitude of finish options. You may find for example that choosing a Rosewood or Oak woodgrain finish will help to blend more sympathetically with your home and garden.

Colours such as black, grey, cream and green are also increasingly used to great effect as well as an array of bespoke coloured woodgrain colours. And remember, unlike their timber equivalents, they will not need painting, and they will be guaranteed for years to come.



Timber Style Windows

If your home is suited to something more traditional in design, our Suffolk Collection may be the perfect solution for you.

Suffolk Windows are made with all of today's modern and robust materials, but manufactured to incorporate the best of yesterday's period features.

Suffolk

WINDOW COLLECTION

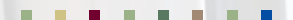

Energy Efficient Windows

We acknowledge our responsibility to the environment and believe that energy ratings are essential in helping you to make an informed decision when purchasing new windows and doors.



How and why are windows tested

Window manufacturers supply the British Fenestration Rating Council with accurate drawings of the window sections, together with details of the type of glass sealed units used.

Computerised simulation tests are then carried out to assess:

- 1) Solar Heat Gain.
- 2) Thermal Losses.
- 3) Air Losses.

Based on these results all windows are then certified from an 'A' Rating to 'G' Rating ('A' being the best possible energy saving performance window).

Modern glass technology offers a range of glass types that, together with new warm edged spacer bars and argon gas cavity infill, help achieve lower U-values and provide a far more energy-efficient window.

Energy-efficient windows will help to reduce the heat lost from your home, reduce Co2 emissions and reduce your home heating bills.

Air losses (Negative)

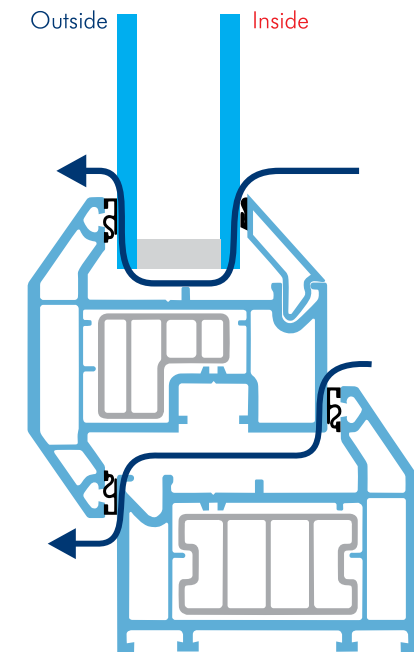

warm air leaks out through the window

Thermal losses (Negative)

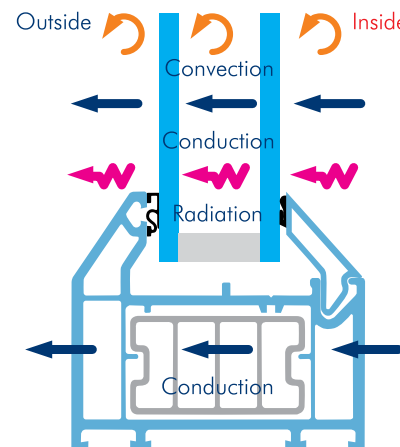

Thermal losses from convection, conduction and radiation

Solar heat gain (Positive)

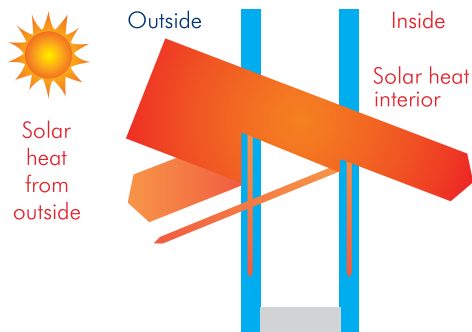

Solar heat is reflected, absorbed and transmitted

Why choose Tricept?

In order to meet the governments thermal performance targets and current Building Regulations, all replacement PVC-u windows are to achieve a U-value not exceeding 1.6 (W/m².K), therefore certified to Energy Rating 'C' or better.



Tested using a variety of glass configurations, together with PVC-u Thermal Inserts, Tricept windows achieve ratings in all three categories from 'C' through to 'A' Rating.



The red glow shown left, on the internal face of the entire window area symbolises the amount of heat Tricept windows retain.

As a result, the inside of your property remains warmer and more energy-efficient.

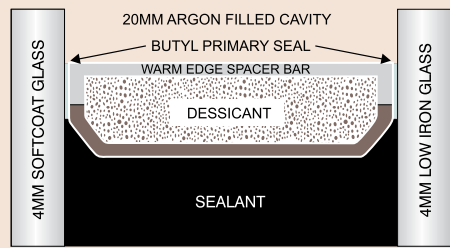
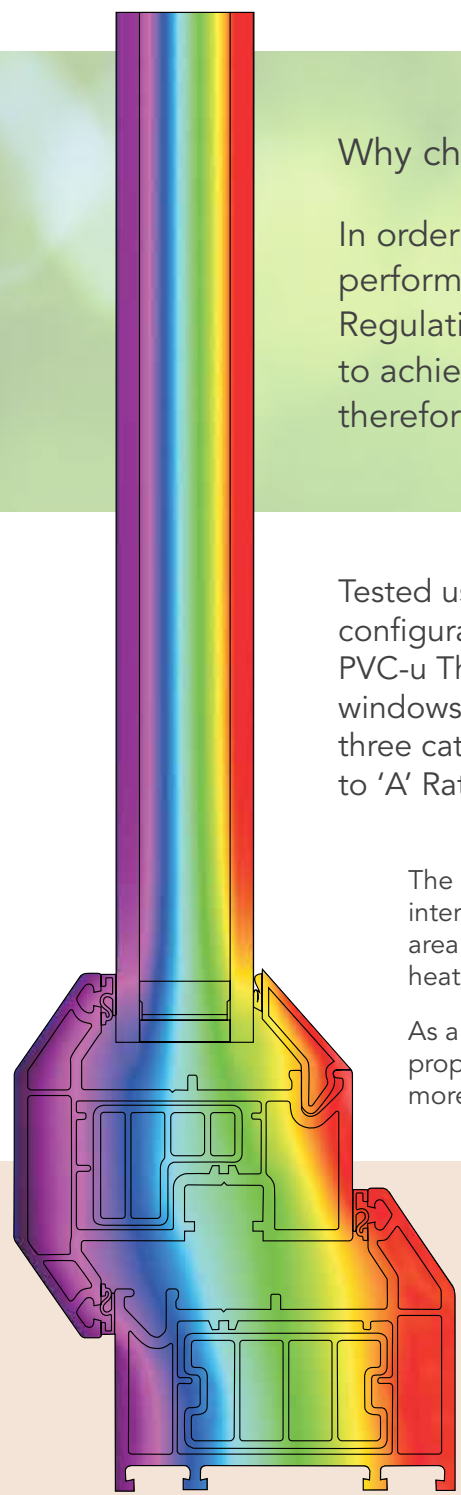

Typical A-Rated Sealed Unit

Tricept thermally-enhanced frames, together with energy-saving sealed units, will provide you with one of the most energy-efficient windows available. This will help to reduce heat loss from your home and save you money on your heating bills.



REST Assured



Tricept Window Security

Fitted with the unique Tricept 10 point locking system you can feel safe and secure in your home knowing that every opening window is secured on all 4 sides.

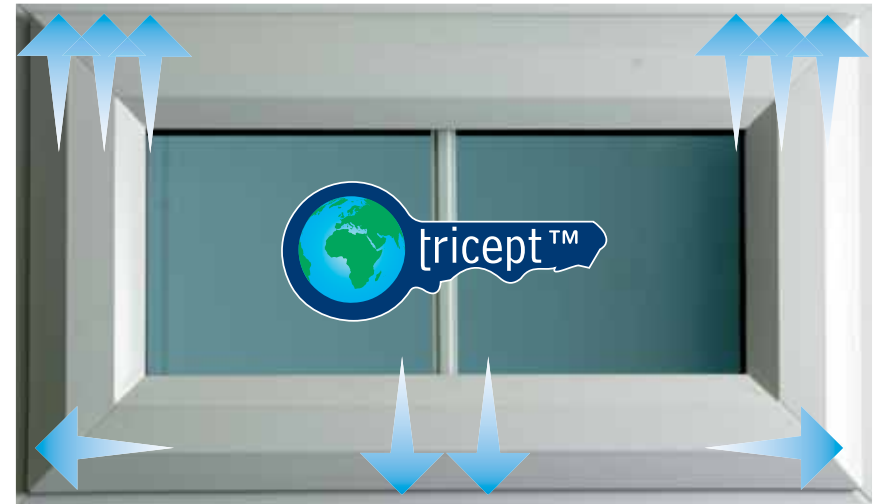

WINDOW SECURITY



Tricept 10 Point Lock

2 x 8mm full length solid shoot-bolts.
2 x stainless steel hinge locks.
4 x 8mm IXEF dog-bolts.
Twin-cam lock providing 2 centre locking points.



Key Locking Handles

Handles lock automatically on closing, and are opened by depressing the button. Key operated to deadlock. Available in white, gold, chrome and black.



IXEF Keeps & Dog-bolts

For a neater appearance, Tricept windows include IXEF keeps and dog-bolts. IXEF is the hardened material used in crash helmet technology. It is stronger than brass, anti-corrosive and will not show scratches or similar.



Bidirectional Centre Lock

To enhance security further and increase compression, all Tricept opening windows include a bidirectional twin-cam centre lock.

You have a choice of bevelled or ovolo frames depending on your preference and the style of your property.



Bevelled



Ovolo

Choose from white, gold, chrome and black locking handles



Choose from a range of frame finishes



White Gloss



White Woodgrain

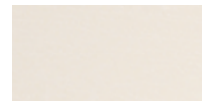

Cream Woodgrain



Irish Oak



Light Oak



Rosewood



Grey Woodgrain



Black Woodgrain



Chartwell Green

Colour options may vary depending on your chosen frame style (bevelled/ovolo). Please ask your Tricept representative for further information.

YOU Decide

No need to compromise

Tricept windows offer you so many options.

With your choice of window style, number of openings, frame shape and finish, handle and glazing options you should never need to compromise.



Finer Details

Thermal Enhancement

To maximise thermal performance, Tricept is engineered from 70mm wide profile (the industry maximum).

The innovative PVC-u reinforcing ensures optimum energy efficiency with a total of 7 vertical chambers helping to resist outside temperatures and retain the internal warmth. This new technology results in far greater heat retention than achieved by conventional hollow metal reinforcing.

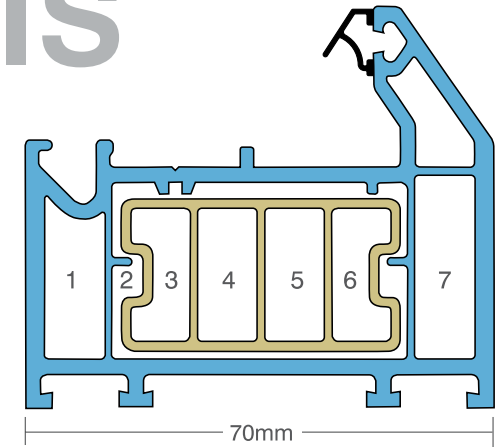

▶ Tricept Thermal Inserts are 800 times more thermally efficient than conventional metal reinforcing.

▶ Tricept Thermal Inserts surpass BS Wind Loading tests by 400%.

▶ Tricept Thermal Inserts surpass BS Screw Retention tests by 80%.

The more alike two products appear, the more important their differences become.

You would be forgiven if you thought a window is just a window and that all the available products out there are essentially the same... this is not the case.

The manufacturers of Tricept have worked hard to ensure the products installed into your home, provide tangible benefits in terms of energy efficiency, comfort, safety and security.

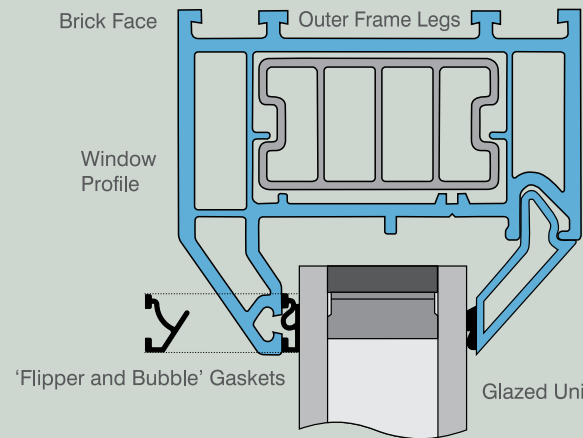

Neat Installations

To ensure your windows are fitted neat and square, and to prevent 'bowing' upon installation, two 5mm legs have been formed to the brick facing edge of the profile to provide a solid fixing.

Weather Resistance

You should expect your new windows and doors to be completely draught proof and water tight. Tricept is produced with all weather compression gaskets, fused to both the inner and outer frame sections.

The gaskets offer a 'flipper and bubble' effect to guarantee far greater compression and remain in line with the profile for a neater appearance. Because they are fused to the profile they can never shrink back thus avoiding any leaks or irritating draughts in your home.

To enhance the weather resistance further Tricept has a sophisticated 'built in' drainage system that directs any water penetration away and towards the external drainage route.

Correct Glazing

In order to avoid the breakdown of glazed units it is essential that your unit remains in dry conditions at all times.

Tricept have designed a unique glazing packer that is sprung in place for the glazed unit to sit on and therefore create a bridge between the sealed unit and any water or dampness. This prevents condensation forming inside your units.



1. Energy Rated Sealed Unit.
2. Moisture Absorbent Warm Edge Spacer Bar.
3. 4mm Sealant.
4. Glazing Bridge Packer.
5. Thermal Reinforcing.



Top Grade PVC-u

European Committee standards state that Grade A PVC-U must have an outside wall thickness of at least 2.8mm.

Tricept wall thickness is 3mm which offers superb frame strength and rigidity that will last for years.

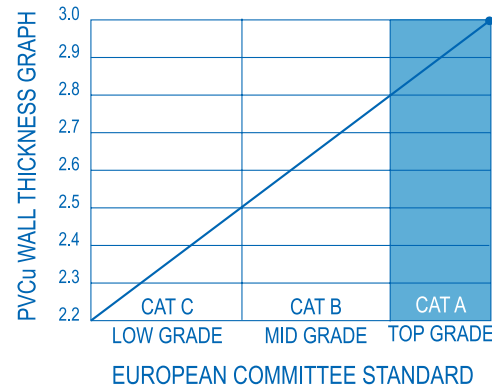
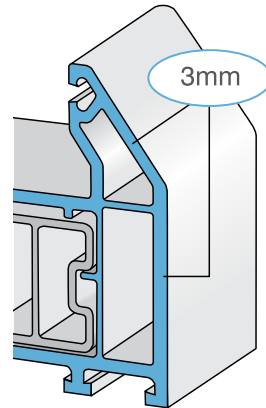

Ali-lock Georgian Bar

You may decide to have decorative Georgian Bars applied to your windows.

The unique Tricept Ali-lock Georgian Bar includes scribed PVC-u clip-on bars connected to full length aluminium fixing strips. This innovative system ensures the Georgian grille does not shrink, warp or detach, regardless of weather conditions.

Smart Safety Solutions

For your safety, easy clean / fire escape hinges are fitted as standard to all side-opening windows.

These will open to a full 90° to give you an alternative means of fire escape (dependent on window size) and can slide towards the centre to allow easy external cleaning.





Tricept Doors

Choosing the right entrance door for your home is essential, your front door creates the first impression and the all important kerb appeal.

Allow yourself time to decide what is right for your home, whether it be traditional or contemporary you are sure to find a style that suits. Tricept gives you endless style and colour choices, so now your door can really reflect your personality.

Using a combination of coloured woodgrain PVC-u with elegant door furniture, it's now possible to emulate most timber style doors. Your choice of door and glazing design can help define the overall style of your home and add light to an otherwise darkened hallway.



Traditional, Classic or Contemporary?

With so many colour, furniture and glazing options available you will have everything you need to create your desired effect.

French Doors

All Tricept French doors are fitted with matching handles to both doors and include the same multi-point lock as fitted to single doors with additional shoot bolts to the slave door.



WARM

Welcome



Whether you are considering a front or back door, you should feel confident in the security. There have probably been more security developments on doors than most other products.

Depending on the available opening height, your door can include as many as 14 locking points all around the door, easily surpassing regulations set by British Standards. Even the hinges have been developed to include anti-jemmy technology.

So after you have selected your preferred style and decided on the practicalities such as open in or out, hinged left or right, you can then sit back and feel safe and secure in your home.



Just a small selection of the 22 Suffolk Door styles available

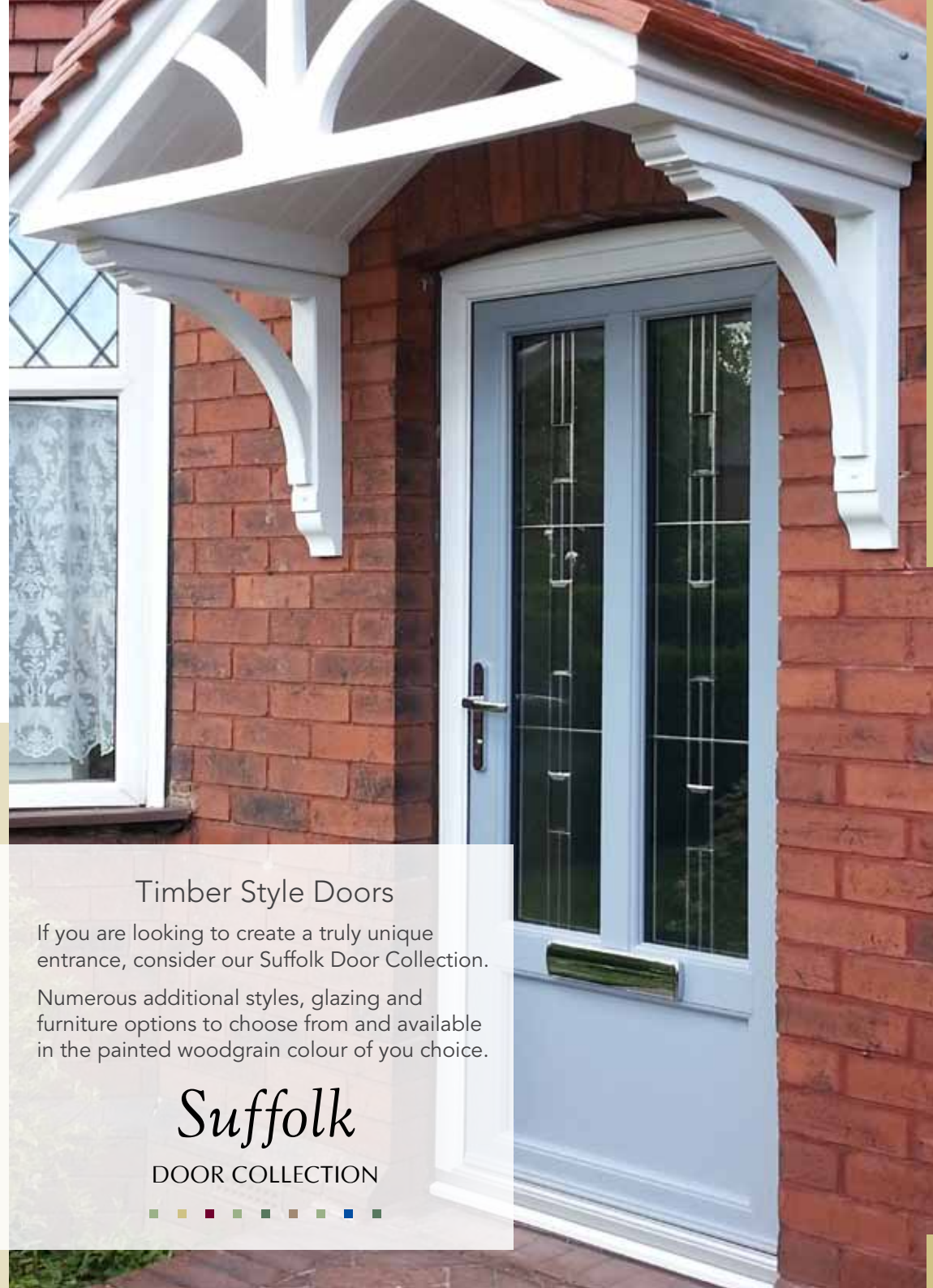

Timber Style Doors

If you are looking to create a truly unique entrance, consider our Suffolk Door Collection.

Numerous additional styles, glazing and furniture options to choose from and available in the painted woodgrain colour of your choice.

Suffolk

DOOR COLLECTION



FEEL Secure



Tricept Door Security

For your security, all Tricept doors are fitted with a unique 12/14 point multi-lock. Simply by lifting the handle upwards, all 12/14 lock features are engaged.



BS EN1303:2005
KM559658

Anti-manipulation Cylinder

To prevent cylinder manipulation, Tricept entrance doors are fitted with the unique Magnum Superior cylinder and then key locked shut.



The Magnum Superior cylinder is Kitemarked and surpasses all of today's security requirements and for your convenience all Tricept doors are supplied with 5 keys as standard.

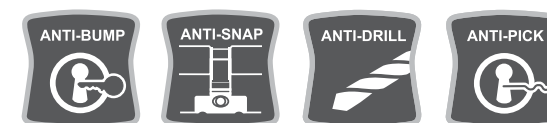

DOOR SECURITY



Tricept 12/14 Point Lock

- 2 x top and bottom shoot bolts.
- 3 x outer/inner facing hook locks.
- 2 x dead-locks.
- 1 x centre locking latch.
- 4/6 x roller cams (dependent on door height).



Shoot-bolts

For maximum security all doors have shoot-bolts top and bottom. Simply by lifting the handle upwards, the shoot-bolts as well as all other lock features are engaged.



Compression

Tricept doors include 4/6 roller-cams (dependent on door height) which ensure a tight seal when the door is closed.



Hinges

3 high security fully rebated hinges including anti-jemmy claws to each hinge. Colour coordinated to profile.

As with Tricept Windows, you have the choice of bevelled or ovolo frames.



Bevelled



Ovolo

Choose from white, gold, chrome and black furniture



Choose from a range of standard door finishes or have your new door painted in the colour of your choice (see Suffolk Door Collection).



White Gloss



White Woodgrain

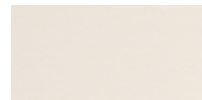

Cream Woodgrain



Irish Oak



Light Oak



Rosewood



Grey Woodgrain



Black Woodgrain



Chartwell Green

Colour options may vary depending on your chosen frame style (bevelled/ovolo). Please ask your Tricept representative for further information.



Letterboxes to match furniture

Tricept products are made at state-of-the-art UK-based production facilities, driven by the very latest barcode technology. This innovative technology backed up by a highly skilled workforce achieves the perfect balance between automation and attention to detail.

TOTAL Precision

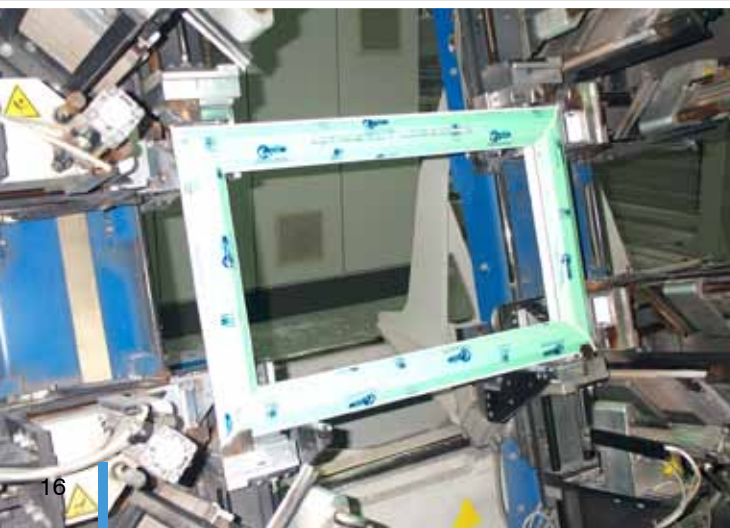

Tricept products are put through regular stringent tests to ensure a consistent high level of quality, but don't just take our word for it...

The British Standards Kitemark is one of the most well known and respected product certification marks in the world and is your reassurance that BSI has checked that your Tricept PVC-u windows and doors comply with the latest British Standard.

Environmental Management System - ISO 14001:2004

Tricept were one of the first PVC-u window and door manufacturers to achieve certification of this most prestigious standard relating to the managing and control of its environmental policies. Issues such as wastage, recycling and energy efficiency are regularly monitored and assessed to maintain maximum environmental working practices.



ISO 14001:2004
EMS 530786

Quality Assurance ISO 9001:2008

This certification was awarded for providing a high level of Quality Control systems throughout manufacture, administration, health & safety, and products including that of our suppliers such as profile and hardware. We are required to give BSI unrestricted access to our offices and factories and allow random samples to be selected for testing on a regular basis.



ISO 9001:2008
FM 21551
FM 33147

The British Board of Agrément

A Government partnered organisation to provide authoritative information on the performance of building products. To gain accreditation, Tricept products were assessed in 3 separate areas: laboratory testing, site inspections and factory production control. Rigorous testing included air permeability, water tightness, effect of wind loads, thermal efficiency, durability of fittings, resistance to impact, racking and bending and ease of operation.



BS 7412
KM 95917



BS 7412/PAS24
KM 95918



PAS23-1 PAS24-1
KM 98428



BS EN1279 PT2

KM 21528
A&B Glass

KM 37462
AG Glass



BS7412. PVC-U Windows

A standard for PVC-u windows whereby a series of mechanical and manual tests are carried out to ensure windows against weather performance and durability.

Enhanced Window Security (formerly BS7950)

A standard for PVC-u windows whereby a series of mechanical and manual tests are carried out to ensure windows against an accepted level of burglar resistance.

Enhanced Door Security

A standard for PVC-u doors whereby a series of mechanical and manual tests are carried out to ensure doors against an accepted level of burglar resistance.

BS EN1279 PT2. Sealed Units

A thorough and daily test routine for double glazed sealed units is carried out to ensure certification. Tests prove that sealed units adhere to correct dew point, sealant correctness and desiccant moisture absorbency.

BFRC. Window Energy Ratings

Windows are assessed using specific glazing and given a rating from A-G for energy efficiency.

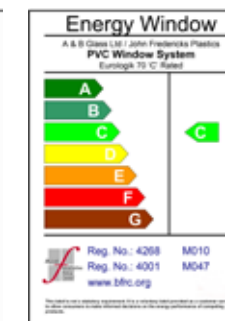
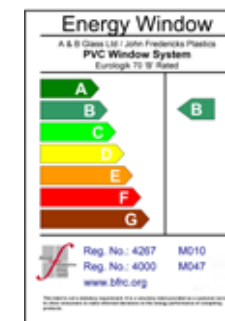
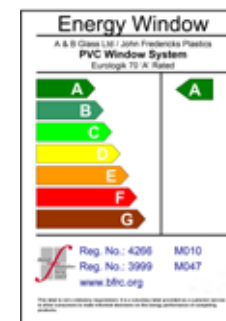

QUALITY Installations

Clean and accurate installations

Naturally, you want to be assured that the quality of installation will match the quality of the products. Companies that are registered with FENSA (or other equivalent self-assessment schemes), work to an agreed code of practice that includes a full understanding of building regulations and all other government requirements.

Prior to your installation, a full and accurate survey will be carried out. This survey ensures that your favoured style of windows or doors will blend sympathetically with your home.

All selected Tricept installers also work to a manufacturers code of best practice in order to achieve the highest level of consistent workmanship and service.

The areas outlined in our installation code of best practice include:

Professionalism

Conduct & Work Ethics

Health & Safety

Communication



So What is FENSA?

FENSA stands for the Fenestration Self-Assessment Scheme. It was set up at the request of the Office of the Deputy Prime Minister to ensure that anyone who installs replacement windows or doors complies with current building regulations, thermal performance requirements and safety standards.

When having windows and doors replaced, homeowners must ensure that they get a certificate of compliance. This will be organised upon completion by your FENSA-registered installer. Upon selling your property your solicitor will ask for this certificate as proof of compliance.

Is it a problem if my installer isn't FENSA registered?

Not necessarily as other equivalent industry governing bodies are now in operation and your installer may have chosen to use an alternative Self-Assessment Scheme to FENSA. Rest assured that as a Tricept Approved Installer, companies will be monitored, whether by FENSA, BSI, CERTASS or another equivalent assessment scheme.

COMPLETE

Satisfaction

Alternative styles



Vertical Sliding Sash

Choosing the appropriate window style such as a Vertical Sliding Sash Window can really help to complete the character of a room.

The modern PVC-u vertical sliding window has been developed as an authentic replacement for the traditional wooden sash window.

Unlike its predecessor, the modern PVC-u equivalent reduces maintenance to a minimum and precisely tensioned balances ensure smooth operation.

Not only functional and space saving with the windows opening vertically but also elegant in design with numerous period features.

In addition to the vertical movement, both sashes are also able to tilt inwards enabling the outside surface to be cleaned.



Tilt & Turn

In some instances, an alternative solution to the casement style window is required.

Windows are sometimes positioned above a worktop where you have to reach across to open and close the window. Or perhaps there is restricted space outside where it may not be ideal to have a window opening outwards.

In these situations you may want to consider openers such as inward opening Tilt/Turn windows. These are designed to tilt inwards for ventilation then open in fully for easy clean access.

This inward opening style could also be a suitable alternative for upper level installations, perhaps above a conservatory or similar, offering convenience of cleaning and general maintenance.



Fully Reversible

With a similar appearance to the Tilt and Turn style, the outward opening Fully Reversible window utilises clever engineering to enable the sash to turn a complete 180 degrees.

Simply by releasing the centre handle, the window sash can be rotated externally 180 degrees without interference with any internal furnishings.

This provides easy access for cleaning as well as a possible means of fire escape.

These particular window styles can also provide a good level of light given their large glass surface area.





French Doors

French Doors, often with full height glazing can provide additional light to a room.

They are used both internally as a partition from one room to another or externally to provide elegant access to the garden.

These door styles will also provide a practical wider opening, particularly useful when moving larger items to and from the property. When the opening is too narrow for a Bi-fold or Patio Door, French Doors can often be the perfect solution.

All Tricept French Doors include the same multi-point lock that is fitted to single doors with additional shoot-bolts fitted to the slave door.



Sliding Patio Doors

Modern day comfortable living comes in a variety of forms We all have our own individual taste and lifestyle and therefore have individual needs and preferences when it comes to how we utilise the space in our home.

Some enjoy ultra modern, open plan living where light and space is key. Large glass surface areas such as Sliding Patio Doors will help to bring in more light and provide that contemporary spacious feel.

They are particularly suited to rooms restricted in size or space with the doors sliding horizontally.

Security is covered with opposing hooks locks, internal/external locking, aluminium inter-lock section and anti-lift device.



Bi-fold Doors

Bi-fold doors are designed to provide the ultimate view. These stunning doors instantly create a contemporary look and feel.

With sleek slimline profiles and sympathetically designed handles the doors simply concertina together so you are able to enjoy the maximum opening and invite the outside in.

Modern Bi-folds are designed to withstand the rigours of the UK climate allowing you to sit back and enjoy your garden in comfort all year round.

Bi-folds are available in up to 7 door leaves, over 20 different opening configurations and a range of frame and furniture colour options.



Stable Doors

Perfect for the country cottage kitchen, PVC-u Stable Doors will add character and functionality to a property.

A sophisticated mechanism allows you to open the top sash independently or both sashes together in the traditional manner.

Security is not compromised as a multi-point lock is featured on both sashes and the door can be locked top and bottom.

Stable Doors are available in a variety of colour options and glazing can be selected to suit your property.

As with traditional entrance doors, Georgian Bars can be added to complete the cottage style appearance.





www.tricept.co.uk



In keeping with market trends and improvements we reserve the right to change specifications accordingly and without notice.