



**FLOTTWEG CENTRIFUGE TECHNOLOGY
FOR OIL SLUDGE TREATMENT**
Open Up New and Profitable Oil Wells



FLOTTWEG TECHNOLOGY FOR OIL SLUDGE TREATMENT

Efficient Centrifuge Technology for the Treatment of Oily Waste Water

The processing of crude oil in refineries and petrochemical plants creates oil contaminated waste water. Processing this waste water signifies separating the waste water into its main components consisting of oil, water and solids. Due to the increasing significance of oil, the objective lies in recovering as much oil as possible and in disposing other components like water and solids in an efficient way.

The static separation generates the first step of the process. Oil concentrates on the surface whereas the solids sink to the bottom of the API-separator as sludge. Due to this, a water phase results between these two components. The floating layer of the surface and the sludge coming from the underflow of the above explained static separation are consolidated and further processed as oil sludge. According to these points, the unique Flottweg Tricanter® enables to separate the three-phase mixture consisting of oil, water and solids in just a single step.

The pre-treatment of oil with a Tricanter® is crucial for the efficiency of the process. Heating reduces the viscosity of the oil. Moreover, it is possible to add emulsion breaker (chemicals) in order to improve the process of separation. By adding polymer flocculation or precipitation agents, fine solids particles can be separated more efficiently. The

water from the API separator goes first to a flotation plant where the floating solids and remaining oil are separated. The separated floating solids and the oil can be further processed together with the oil sludge.

The actual waste water treatment is done in a mechanical-biological sewage plant. Waste water treatment generates sewage sludge which should be as dry as possible in order to reduce the costs of transport, disposal or incineration. Especially developed and manufactured for such purpose, the Flottweg HTS Decanter® is not only used for high dewatering of sewage sludge but also the perfect solution in industrial and municipal sewage plants.

For a better overview and understanding of how oily waste water is processed with Flottweg Centrifuge Technology, please have a look at the process scheme on the next page.

© = registered trademark in various countries

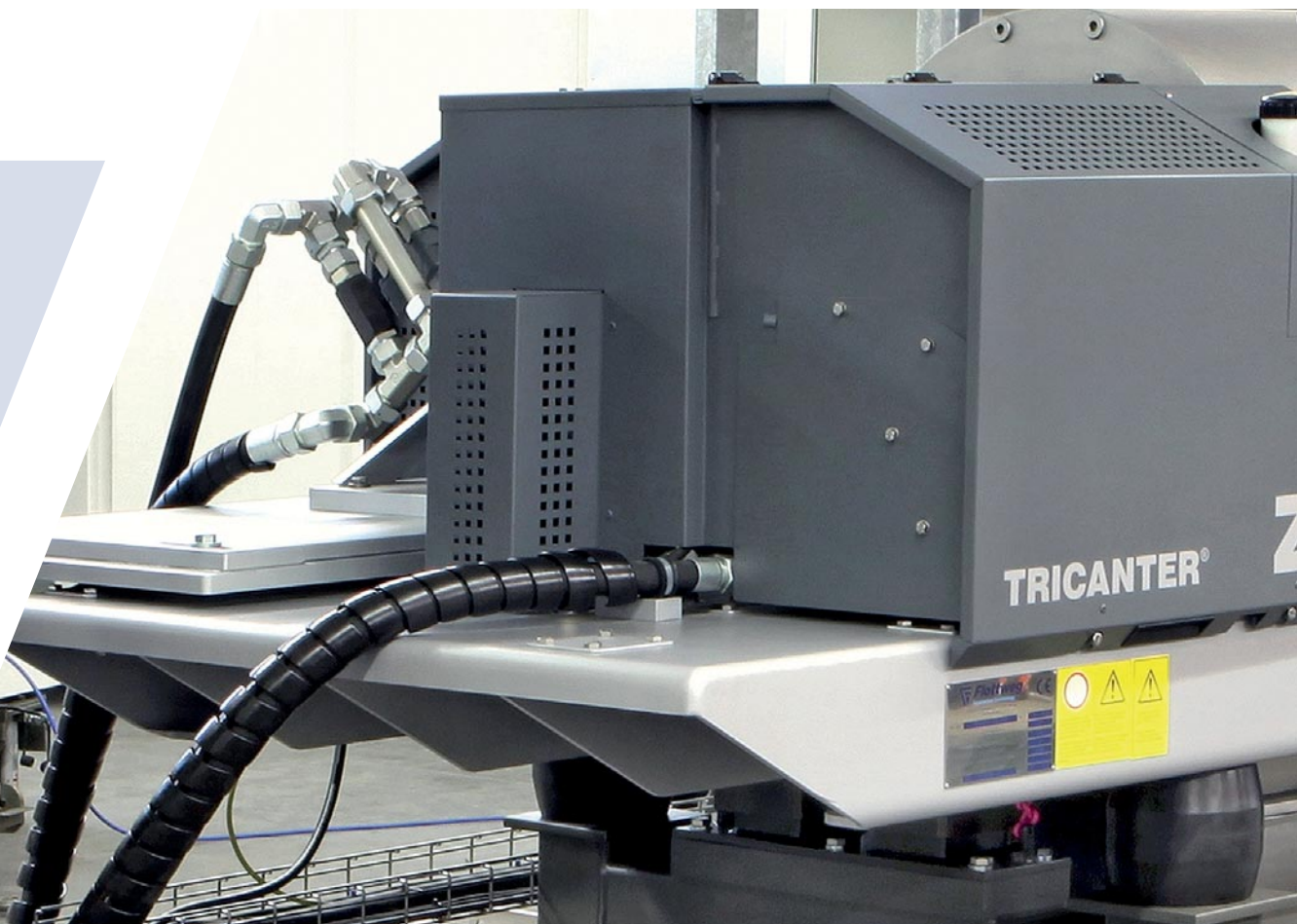

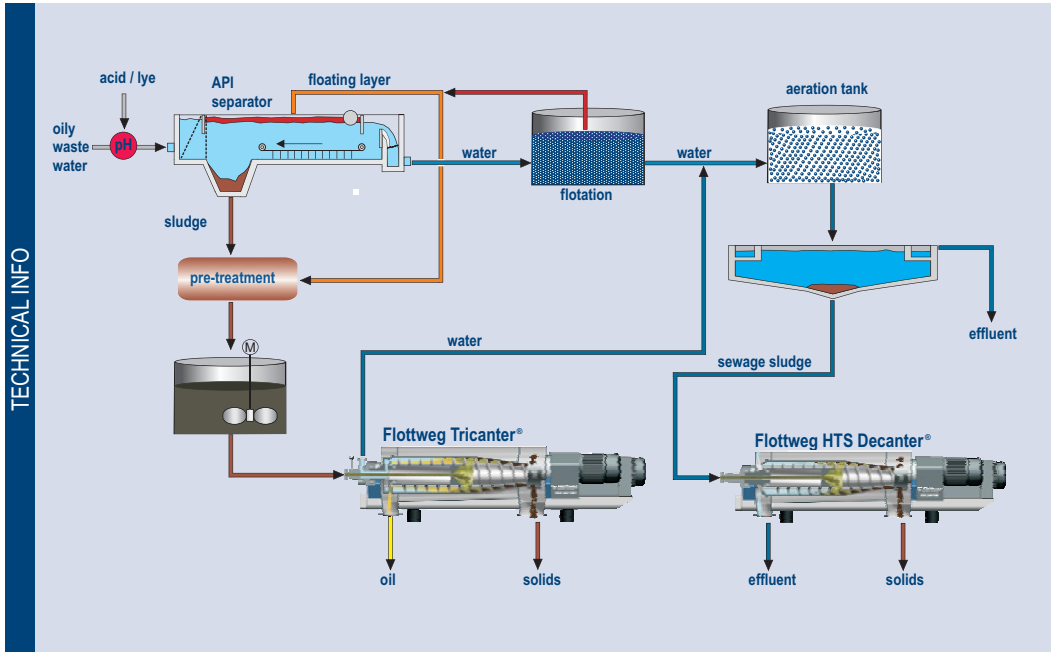

Oil and sewage sludge treatment with Flottweg Technology

Flottweg Tricanter® System

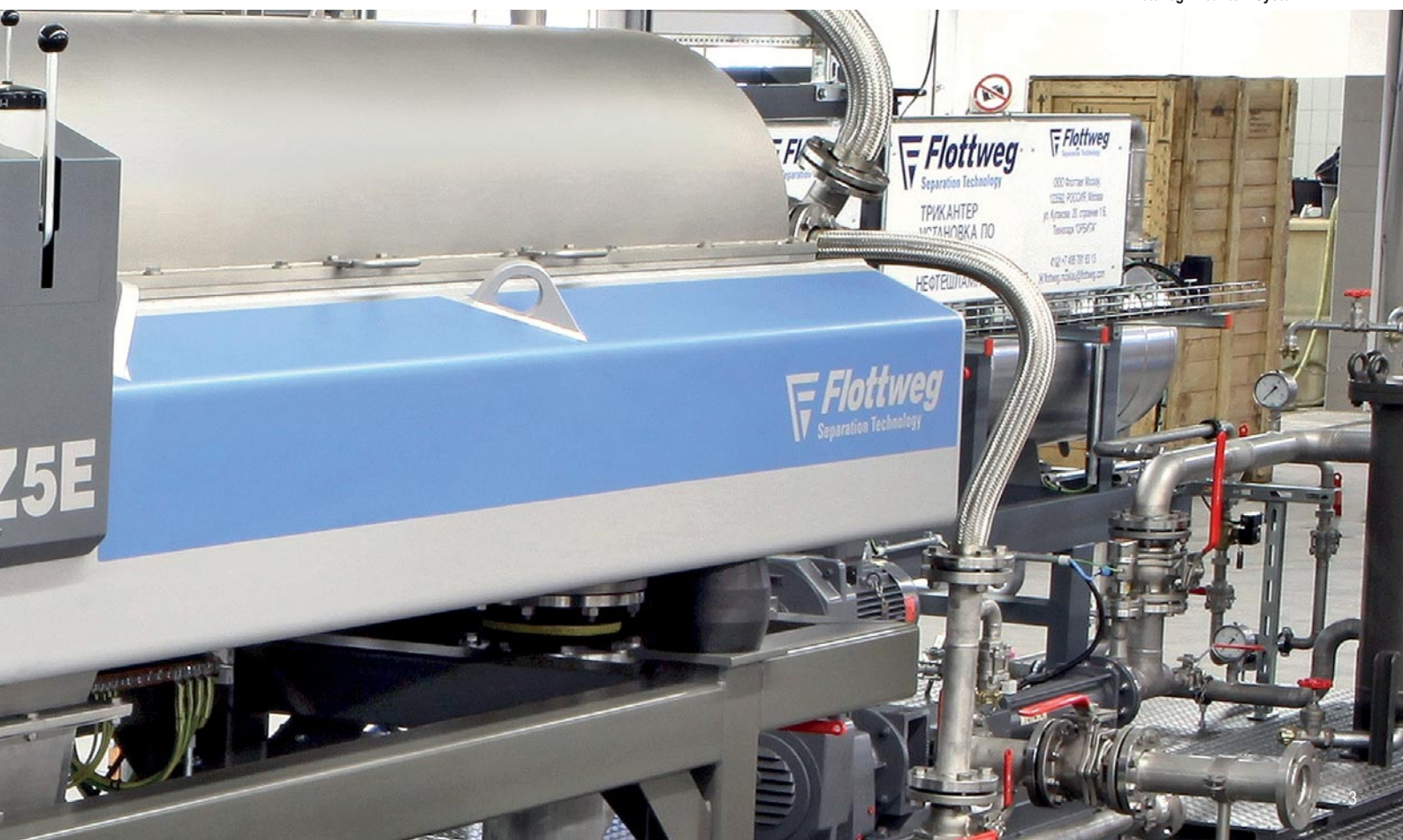

FLOTTWEG SEPARATION TECHNOLOGY

High Quality Centrifuge Technology for Oil Recovery from Lagoons and Sedimentation Ponds

In the recent past, it was common to dump oily residuals from refineries, petrochemical plants, and other industries into large sedimentation ponds. Moreover, still and even today, huge lagoons and ponds can be found in many places across the globe where residuals have been settled at the bottom for years or even longer. Flottweg provides complete systems and necessary equipment to effectively process the residues and recover the valuable oil.

An oil-suction unit that enables the extraction of oil sludge from a defined depth below the pond's surface is part of the Flottweg Oil Recovery System. The suction pump is mounted on a pontoon that floats on the surface of the pond or lagoon. If the suctioned portion contains high contents of paraffins and asphaltum, the oil sludge is liquidized in the suction pipe using steam operated heater coils. The extracted oil sludge is then processed as follows: The slop oil is heated, emulsion breaker and flocculants are added, and finally, oil, water, and solids are separated with a Flottweg Tricanter®.

The Flottweg Tricanter® and its customer benefits

- Greatest possible purity of the liquids to be separated, by using the impeller
- Experience of more than 40 years enables maximum continuity, versatility and performance.
- Other processing steps/separating stages can be dispensed with, or are no longer required, thereby offering cost savings for the plant owner.
- Adaptation to changing conditions (product in the feed) possible at any time
- Automation is possible.
- Produced, manufactured and developed in Germany, for the highest possible production quality.

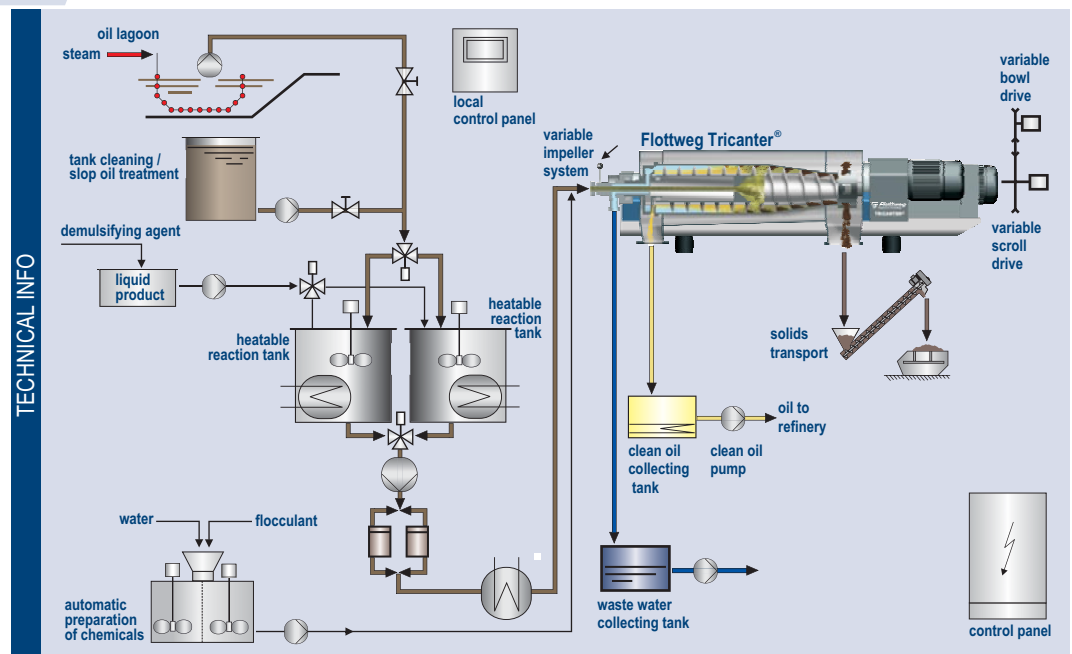

Oil recovery from lagoons and sedimentation ponds with a Flottweg Tricanter®

FLOTTWEG TECHNOLOGY FOR OIL SLUDGE TREATMENT

High Performance Separation Technology for Oil Recovery from Residuals during Tank Cleaning

Crude oil is stored in tanks ranging in size from 5,000 cubic metres (1.3 mil gallons) to 130,000 cubic meters (34 mil gallons). As time goes by, a wax-like layer consisting of heavy hydrocarbons and inorganic impurities such as sand, rust, and heavy metals builds up on the bottom of the tanks, thereby reducing the utilizable tank volume.

to recover the major part of the oil, to deliver water stream that can be fed to a sewage treatment plant, and to reduce the volume of the solids phase. Finally, only 10 % of the original quantity remains for incineration.

Prior to safety inspections, maintenance work, and repair jobs, the tank has to be completely emptied and cleaned. Tanks are cleaned with crude oil, diesel oil, and water. Depending on the size of the tank, up to 1,000 metric tons of residuals remain for disposal or incineration after cleaning. These residuals can be processed using a Flottweg Tricanter®

For a better overview and understanding of how oily waste water is processed with Flottweg Centrifuge Technology, please have a look at the process scheme below.

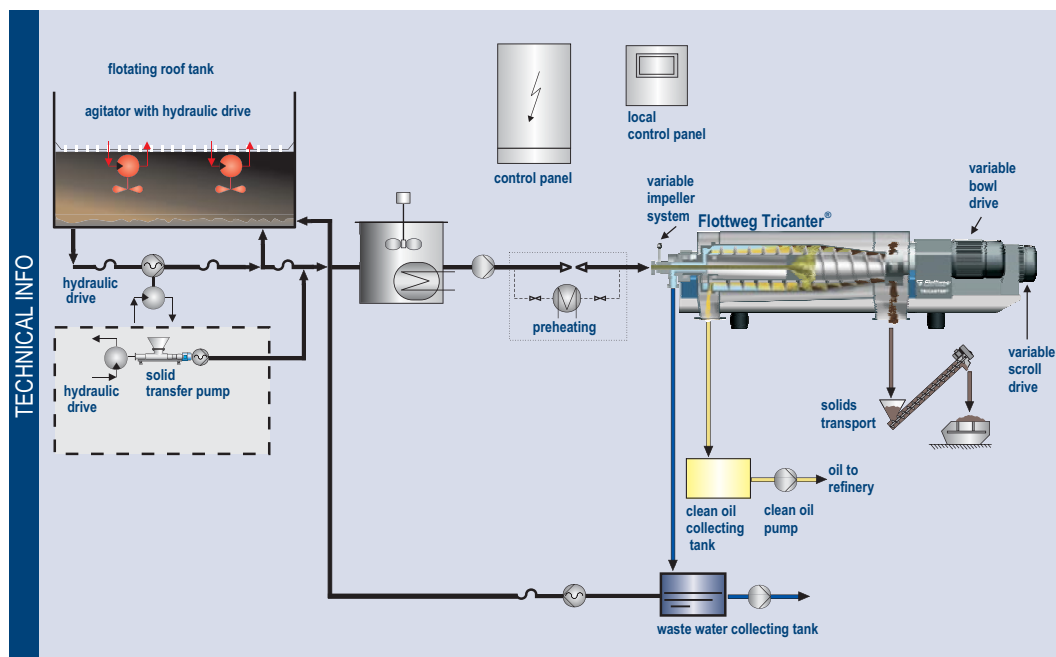

Oil recovery from residuals during tank cleaning



FLOTTWEG TECHNOLOGY FOR OIL SLUDGE TREATMENT

Separators for Cleaning Oil from Oil-Sludge Processing

THE FLOTTWEG SEPARATOR

In many aspects of process engineering, separators are used for mechanical separation and clarification of mixtures comprising solids and liquids. An AC separator (Automatic Cleaning) is liquid-oriented and works with a higher rotation speed than a decanter. As a result, the generated centrifugal acceleration (g-force) of a separator is significantly more powerful than in decanter centrifuges. Flottweg Separators are suitable for separating ultrafine solid particles from a liquid (clarifier separator) as well as for separating mixtures of liquids with different densities at the same time as separating a solid (purifier).

According to the above named utilization, a Flottweg Separator can be used for oil sludge processing due to the requirement of a high purity of oil. The feed stream for the Flottweg Separator can contain residual water and solids. The oil coming from the Flottweg Tricanter® is collected in a special tank where it is heated to 90 degrees before being processed via a separator. Generally, a residual basic sediment + water with a content of less than 100 PPM is achieved after separation.

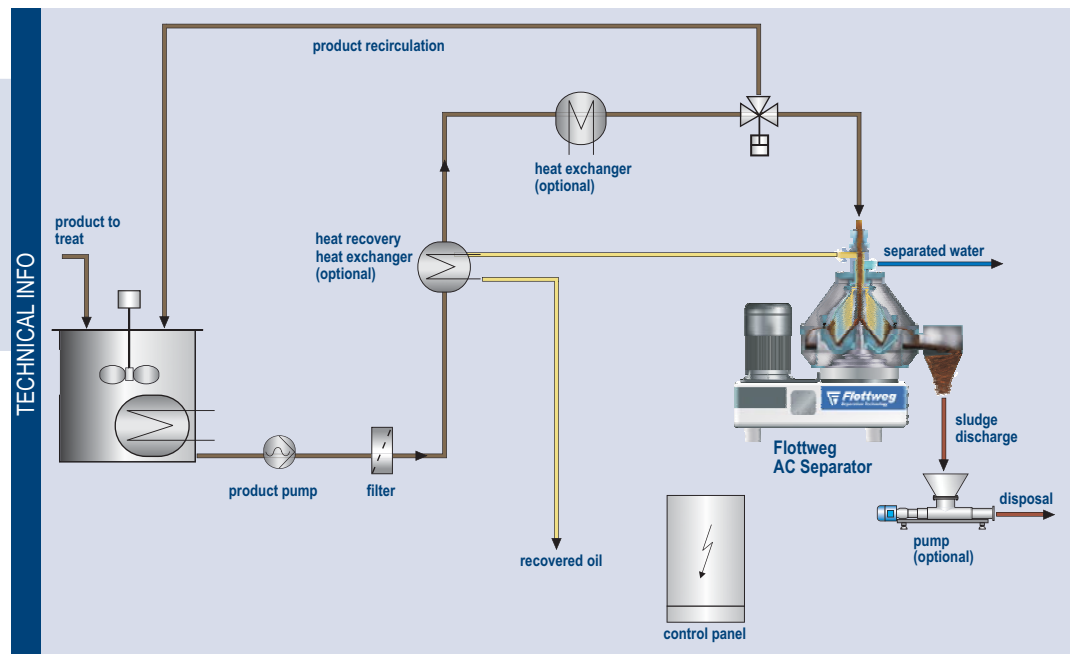

Oil sludge treatment with a Flottweg Tricanter® and Separator



Flottweg Separator for cleaning oil from oil sludge processing

THE FLOTTWEG SOFT SHOT® DISCHARGE SYSTEM FOR THE SEPARATOR

A Separator from Flottweg is equipped with the Soft Shot® discharge system. This solids discharge system allows precise combinations of partial and full discharges, as required. Depending on the products to be processed and the consistency of the solids, adapting the discharge type allows an optimum operating method. The separator is operated and controlled using a simple and self-explanatory menu system with a PLC. The Soft Shot® makes hardly any noise and can therefore be used in rooms where no special or additional acoustic protection measures are required.

Soft Shot® discharge system and its customer benefits

- Solid discharge operations that make hardly any noise
- Precise partial or full discharges in any combination for maximum product yield
- Reduced wear on the high stress components
- Reduced number of bowl seals
- Meet an extremely wide range of customers' requirements because of variable control of the separator



The picture shows the bowl of a separator

OPERATING PRINCIPLE 2-PHASE

The Flottweg Decanter for Drilling and Tunneling

FEED

The product is fed through a stationary pipe into the feed zone located in the center of the rotating assembly. The product is then accelerated circumferentially and delivered through ports in the scroll into the bowl.



SCROLL

The scroll rotates with a slightly different speed than the bowl and conveys the separated solids towards the conical end of the bowl. This differential speed determines the residence time of the solids in the bowl. Residence time is a critical factor for cake dryness. It can be automatically adjusted by changing the differential speed of the scroll thus providing optimal separation. Depending on the physical properties of the product, Flottweg Decanters can be supplied with a different scroll design or by modifying an existing scroll. Scroll pitch and single or multiple lead configurations are important design variables.



BOWL

The bowl has a cylindrical and conical section. The rotational speed is pre-set optimally to the application and requirements. The slurry rotates with the bowl at the operating speed and forms a concentric layer on the bowl wall. The solids contained in the product are packed against the bowl wall by centrifugal force. The length of the cylindrical bowl section and the cone angle are selected to meet the specific requirements of an application.

SOLIDS DISCHARGE

Settled solids are ejected through ports at the conical end of the bowl into the solids housing and fall vertically through the discharge chute.



OVERFLOW WEIRS

The clarified liquids flow to the cylindrical end of the bowl where they exit over weir plates. Easily adjustable weir plates allow for precise adjustment of the pond depth in the bowl. The liquid overflow is then collected in a centrate chamber and discharged by gravity.

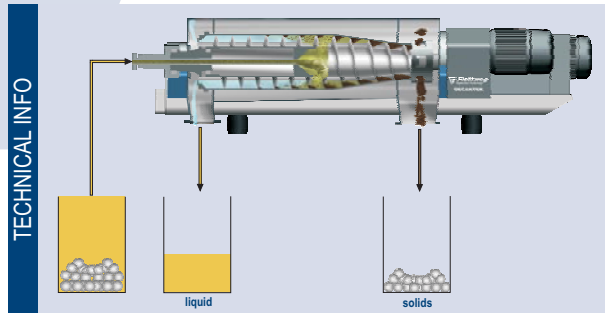

Flow of liquids and solids in a Flottweg Decanter

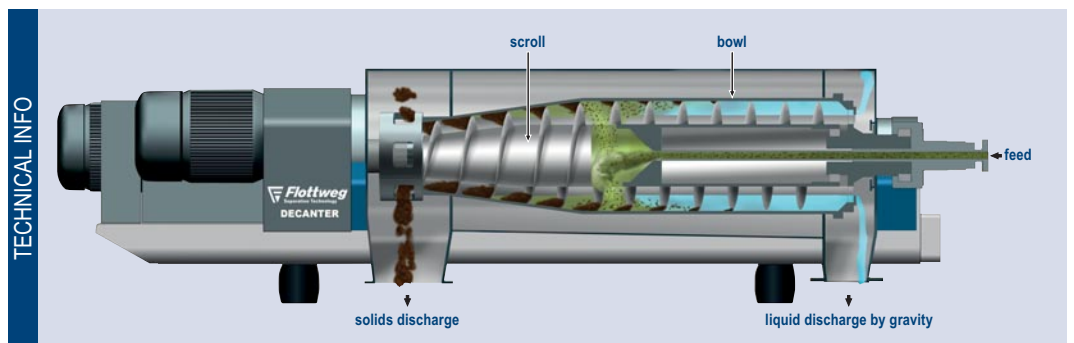

Flottweg Decanter for the separation of solids from liquids with discharge of the liquid phase (centrate) by gravity

The picture shows a decanter scroll

OPERATING PRINCIPLE 3-PHASE

The Flottweg Tricanter®

The Flottweg Tricanter® performs a three-phase separation, i.e. the simultaneous separation of two immiscible liquids with different densities and one solid phase, provided that the solid phase is the heaviest

phase. The main difference from a decanter is the separate discharge of the two liquid phases.

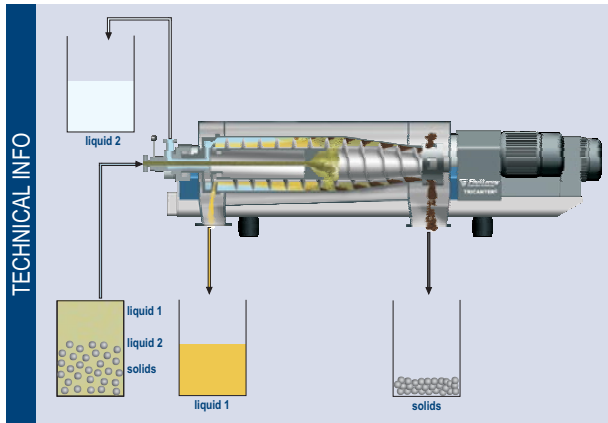

Flow of liquids and solids in a Flottweg Tricanter®

Customer Benefits of Variable Impeller

- Immediate adjustment of the pond depth and liquid-liquid separation zone ▶ optimum results
- Savings in costs due to the needlessness of a separate chamber pump
- Easy reading of the variable impeller scale ▶ ease of adjustment

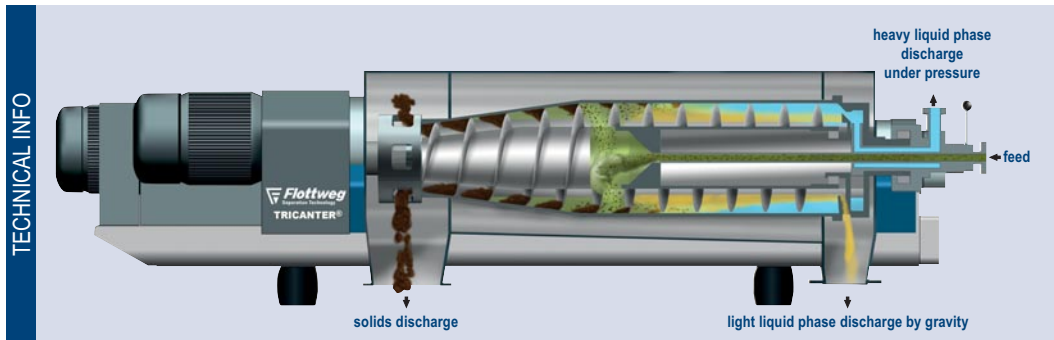

Flottweg Tricanter® (Three Phase Decanter). Discharge of the centrate: heavy liquid phase under pressure, light phase by gravity

NO MATTER IF FEED CONCENTRATION VARIES

The Flottweg Tricanter® discharges the heavy liquid through an adjustable impeller under pressure and the light phase by gravity. The variable impeller allows for precise on-the-fly adjustment of the pond

depth and the liquid-liquid separation zone. This optimizes the purity of the liquids and may eliminate downstream equipment.

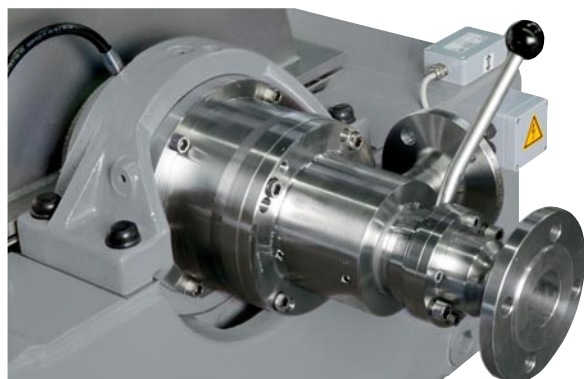

Feed and discharge devices with control lever for the adjustable impeller of the Flottweg Tricanter®

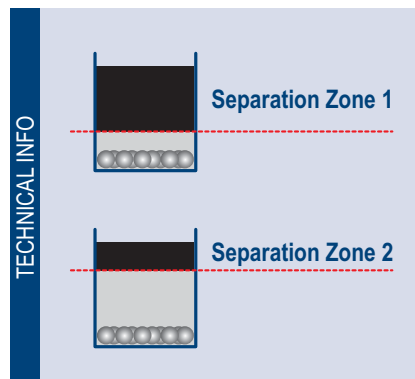

No matter if feed concentration varies: Best separation results with the Flottweg Tricanter®-System

FLOTTWEG SEPARATION TECHNOLOGY – ENGINEERED FOR YOUR SUCCESS

Flottweg has been developing and producing centrifuges for more than 60 years, and is one of the world's leading decanter centrifuge manufacturers. Flottweg convinces customers all over the world with an unique experience as well as an outstanding expertise, especially when it comes to applying and using separation technology for the purpose

of oil sludge treatment. Even more, by using Flottweg Systems and Equipment, customers receive significant and unique benefits in comparison to other providers of mechanical separation equipment or systems.

The Flottweg Benefits for Oil Sludge Treatment

- Significant reduction and elimination of hydrocarbon emissions as well as human health hazards
- The recovered oil (up to 90 % or even more) can be recycled in the refinery or processed and utilized for lubrication processes
- Automatic and continuous operation, even for varying compositions of the Tricanter® feed.
The use of a Tricanter® also provides customers significant benefits, such as:
 - greatest possible purity of separated liquids by using the adjustable impeller
 - adaptation to changing conditions (product in the feed) possible at any time
 - more than 40 years of experience in three-phase applications
- The volume of residues is reduced to only 10 to 20 % of the original sludge quantity.
Solids can be transported, incinerated or disposed in a proper way.
- The recovered oil can be reused as valuable oil. Additionally, a 90 % reduction of sludge dramatically reduces transportation and disposal costs.
- By using a HTS Decanter®, customers can benefit from
 - an energy saving of up to 20 % with the Recuvane® System
 - highest possible dry substances
 - low personnel costs due to continuous and automatic operations

Flottweg Separation Technology – Best practice example in Ecuador



FLOTTWEG DECANTER CENTRIFUGES AND SEPARATORS

for Oil Sludge Treatment

There are numerous advantages of using Flottweg Equipment:

SAVING COSTS

By using Flottweg Technology, the transportation, disposal, and incineration of residues, waste etc. are diminished to a minimum as only 10 % of the original quantity has to be handled. Moreover, the recovered oil can be reused as crude oil. Last but not least, automatic and continuous operation reduces the costs for personnel and illustrates that Flottweg is the best choice.

EXPERIENCED AND FIELD-PROVEN

Overall, Flottweg Separation Technology represents a solution for oil sludge treatment that is as elegant as it is efficient. After all, what can be returned to the material cycle does not have to be expensively disposed of. This increases the efficiency of the system and reduces environmental pollution. Moreover, the fact that Flottweg has been developing and producing centrifuges for more than 60 years, and is one of the world's leading decanter manufacturers, is an important argument. These facts distinct us from our competitors.

FLOTTWEG SYSTEMS AND PLANT ENGINEERING

For processing of oil sludge and other applications regarding the treatment of oil sludge, Flottweg provides mechanical separation technology with the decanter and separator systems consisting of the control panel, explosion-proof operating panel, automatic feed regulation, flow meter etc. Flottweg Systems are completely piped, wired, tested, and commissioned on site by Flottweg's factory-trained and experienced service personnel. Flottweg Machines are also available as skid-mounted systems.

Key Success Factors

- Plant and system construction satisfy individual customer requirements as well as perfectly adjusted processes.
- Flottweg Simp Drive® enables high throughput performance due to high bowl speed and precisely adjusted differential speed.
- Unique wear protection is a key success factor due to the fact that it enables an optimum process even under hardest conditions.
- Flottweg Machines are designed and manufactured to fulfill the aforementioned success factors to ensure and provide the best possible results for an operator.

Customization for satisfying customer needs – The Flottweg Systems and Plant Engineering

Flottweg Engineering in 3D

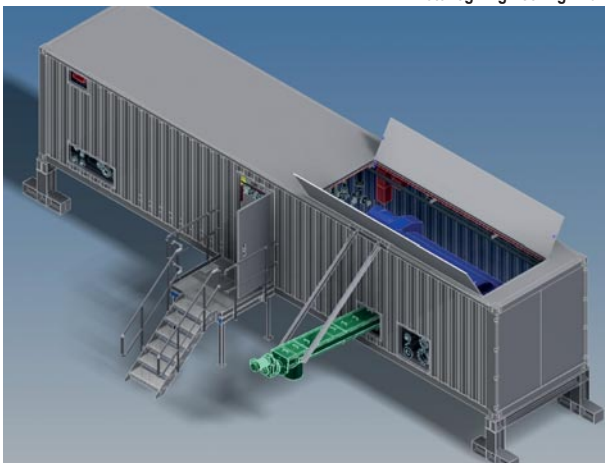

FLOTTWEG PRODUCT FEATURES FOR OIL SLUDGE TREATMENT

Customer Benefits by Using Flottweg Equipment



SIMP DRIVE®: SIMPLE, INTELLIGENT, MODULAR AND POWERFUL

The Simp Drive® regulates the differential speed between the decanter bowl and scroll depending on the prevailing scroll torque. The differential speed determines the length of time the solid remains in the bowl, and thus has a significant influence on the separation process. The bowl speed and differential speed can be adjusted independently of one another during ongoing operation. This is guaranteed by a special transmission mechanism of the Simp Drive® (special planetary epicyclic gear unit).



WEAR PROTECTION

An optimum wear protection is crucial when using a decanter or Tricanter® for many applications. All wear parts are protected by special hard surfaces utilizing tungsten carbide or SIC, and replaceable wear bushings. Under operating conditions, the Flottweg Wear Protection lasts more than 24,000 operating hours.

Replaceable wear protection elements

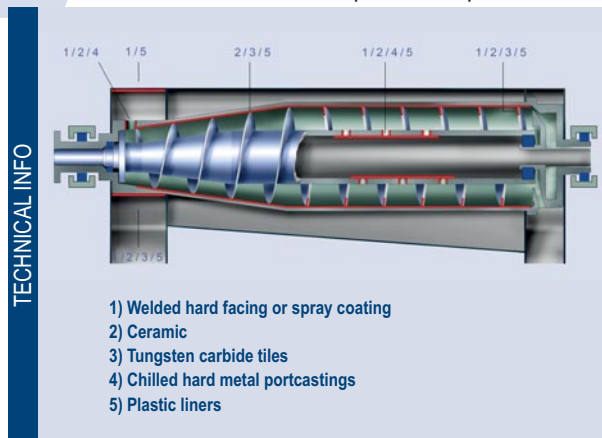

- 1) Welded hard facing or spray coating
- 2) Ceramic
- 3) Tungsten carbide tiles
- 4) Chilled hard metal portcastings
- 5) Plastic liners

Customer Benefits of the Flottweg Simp Drive®

- High flexibility in selection of the operating speed (differential speed can also be perfectly adjusted).
- High throughput performance due to high bowl speed and precisely adjusted differential speed
- Simp Drive® for a broad range of applications in which continuous adaptation of the operating parameters is required.
- Lower energy requirements than conventional gear units due to higher efficiency (cost-saving)
- Machine can be cleared out even at no bowl rotation, because the scroll can nevertheless still be turned (no need to dismantle system components).

Customer Benefits of the Flottweg Wear Protection

- Increased temperature resistance
- Improved corrosion resistance
- High hardness and protection
- Enhanced surface characteristics
- Improved durability of the decanter
- Increased consistency and reliability of the process

The picture shows an replaceable bushing



SEALING SYSTEMS

Flottweg Gas-tight Centrifuges allow for a safe operation with toxic, corrosive or flammable media by applying inert purge gas to rotor seals and by inerting the process chamber and centrifuge housing. Slight positive or negative pressures can be maintained in the process

area by regulating the purge gas supply. Special sealing elements minimize the seal gas consumption.

Customer Benefits of Flottweg Sealing Systems

- Individual adaption of the decanter centrifuge depending on the field of application
- No risk of explosion due to the avoidance of giving off undesirable product emissions to the surrounding area
- Possibility of processing toxic, hazardous or acid products



Flottweg Control Unit for the purging and blanketing with inert gas

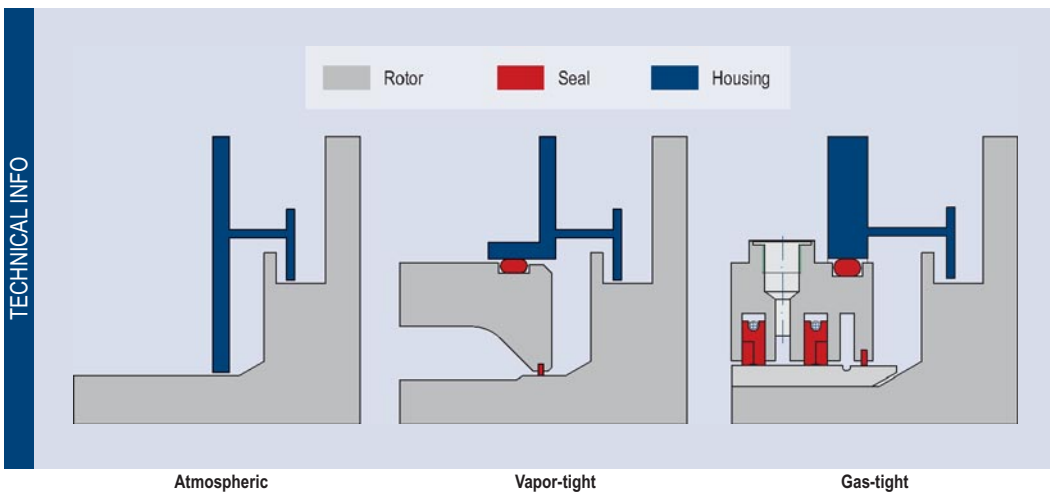

FLOTTWEG SEPARATION TECHNOLOGY AND ITS EXPLOSION PROTECTION FOR OIL SLUDGE TREATMENT

Explosion-proof Flottweg Equipment

FLOTTWEG DECANTER CENTRIFUGES – EXPLOSION-PROOF AND SAFE

Separation technology is omnipresent in various industrial production sectors such as environmental technology, chemical industry, petrochemical industry, mining industry or raw material production. Regardless of the production area, processing of products may cause an explosive atmosphere which in turn illustrates the necessity of equipment, machines and systems that protect people who work in such hazardous environment.

Accordingly, for many applications where Flottweg Decanters and Systems are in use, requirements against explosion hazards are in demand. Especially applications in combination with oil or oily liquids. Due to this, Flottweg Decanter Centrifuges and Complete Systems are designed and manufactured to satisfy the above named demand by fulfilling all relevant and necessary guidelines according to latest ATEX standards.

WHAT IS ATEX?

ATEX is an acronym and has the meaning of Explosive Atmosphere. Flottweg Decanters comply with ATEX 95. But what does that exactly mean? ATEX illustrates the directive 94/4 set by the European Union on March 23rd, 1994 concerning protective systems and equipment intended for use in potentially explosive atmospheres. Since July 1st, 2003 also non-electrical equipment in potentially explosive areas has been subject to a special directive (94/9/EC) also known as "ATEX 95" (unofficial designation).

As already mentioned above, Flottweg Decanter Centrifuges are suitable for processing hazardous materials/products. Moreover, Flottweg Decanters and Systems can be applied where hazardous conditions of zone 1/21 and zone 2/22 are present. The table on the next page shows to what extent hazardous areas are classified and defined.

HAZARDS FROM OUTSIDE

Demands for an explosion proof decanter occur due to the omnipresent environment where a Flottweg Decanter Centrifuge or System is installed, even if the actual product itself is completely non-hazardous.

HAZARDS FROM INSIDE

On the other hand, it is possible that the processed product in a Flottweg Decanter Centrifuge creates an explosive and hazardous environment. If this situation occurs, the danger is caused by discharged solids or by gas which escapes via different sealings.

HAZARDOUS ZONE CLASSIFICATION WITH CORRESPONDING EQUIPMENT CATEGORIES	
CATEGORY 1 EQUIPMENT (ZONE 0 OR 20) ► PERMANENT/FREQUENT RISK CATEGORY 2 EQUIPMENT (ZONE 1 OR 21) ► OCCASIONAL RISK CATEGORY 3 EQUIPMENT (ZONE 2 OR 22) ► SHORT-TERM/RARE RISK	
VAPOURS, GASES	EXPLOSIVE ATMOSPHERE AND ITS FREQUENCY OF OCCURRENCE
Zone 0	Permanent or frequent
Zone 1	Occasional
Zone 2	Short-term and rare
DUST	
Zone 20	A cloud of flammable dust in the air is continuously or frequently present.
Zone 21	During usual operation, a cloud of flammable dust in the air occurs occasionally.
Zone 22	During usual operation, a cloud of flammable dust in the air is unlikely to occur. If so, however, it will just remain for a short period.

PROCESS ENGINEERING AND EXPERTS

Discover New Potential

Every process is different. Various parameters have a significant influence on the separation efficiency. To know those parameters means to increase the efficiency and yield of your separation process.

We support our customers across the entire process chain, from raw material analyses to approval and laboratory tests. Flottweg offers all necessary methods for analyzing your products and evaluate new potentials.

Our worldwide locations and networks guarantee support and service for our customers. With the help of our experience and testing capability we develop customized solutions to meet your individual requirements.

Our Services

- **Laboratory analysis** – discover new options and performance parameters
- **Processing department** – performance optimization of our separation solutions
- **Project planning department** – customized systems and solutions

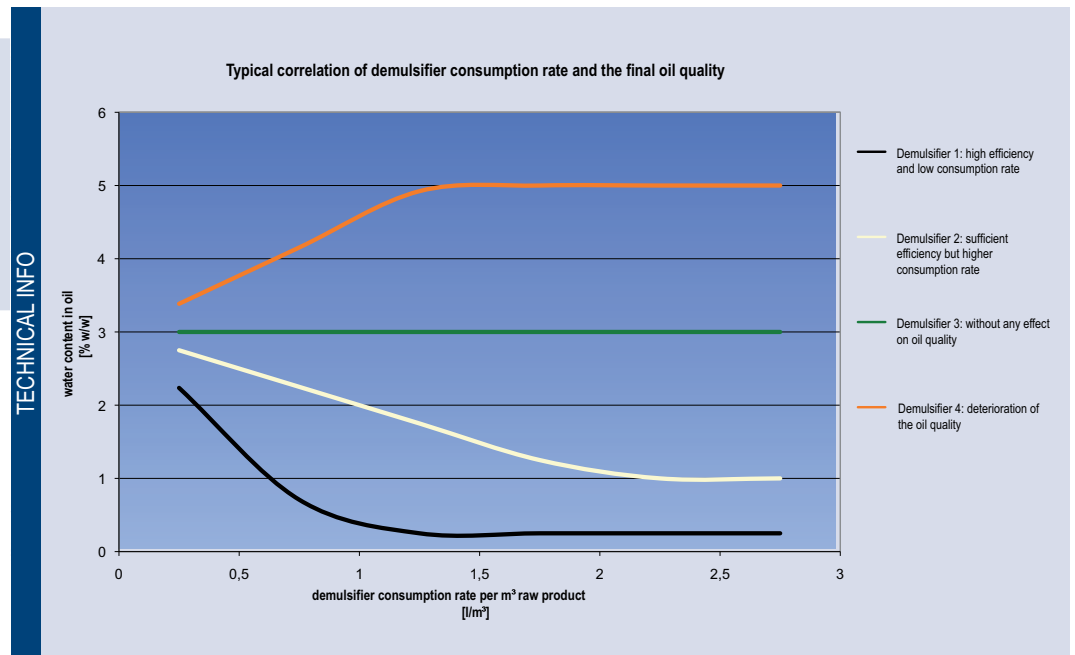

Sample analysis of the dependency and influence of various demulsifiers on oil sludge



TAKE ADVANTAGE OF OUR EXPERTISE ...

... and Many Years of Experience



Flottweg Separation Technology is used worldwide for oil sludge treatments. Decanters and separators are an important component for long term customer satisfaction.

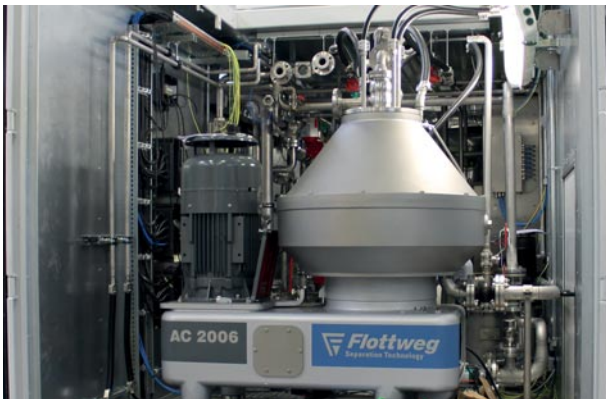

Flottweg AC Separators are used when a high purity of oil is required. Moreover, the Soft Shot® discharge system creates unique customer benefits.



Flottweg System and Plant Engineering for both decanters as well as separators enable highest efficiency of processes for oil sludge treatments



Flottweg Tricanter® Skid for oil sludge treatment

Ask our sales agents for more references

GLOBAL AFTERMARKET SUPPORT NETWORK

No Matter Where You Are in the World



CUSTOMER SERVICE IS OUR STRENGTH

Application-based project planning, high-quality manufacturing and professional after-sales service are prerequisites for a trouble-free operation. Experienced and reliable service engineers from our customer service department are ready to respond quickly if needed. The Flottweg Service Group is also available to perform preventive maintenance in order to avoid interruptions in production.



QUALITY "MADE IN GERMANY"

Flottweg is ISO 9001 certified and manufactures its products in compliance with the latest technical standards.

Flottweg Services Include

- Experienced advice on separation processes
- Pilot tests on-site or at the Flottweg Laboratory and Test Center
- Selection and sizing of appropriate equipment
- Customer-specific automation/control systems and process integration
- Design and construction of complete process systems
- Installation, commissioning, maintenance, repair and spare parts service worldwide

FLOTTWEG AFTER-SALES CUSTOMER SERVICE

Even the best machinery needs to be maintained and serviced. Flottweg has established a worldwide service network consisting of its own subsidiaries, branch offices, and representatives to provide our customers with localized service and spare parts. Our service

engineers and technicians are qualified for any kind of installation, commissioning, repair and maintenance.



Flottweg Service Technicians are always available for you

FLOTTWEG WORLDWIDE

Flottweg is headquartered in Vilsbiburg (near Munich), Germany, and has branch offices in Cologne and Leipzig as well as subsidiaries in Australia, Brazil, China, France, Italy, Mexico, Poland, Russia and the United States plus representatives in nearly all countries worldwide.

Check out our website at www.flottweg.com to find a competent contact person.



TECHNICAL DATA

Decanter Z-Series and Tricanter®

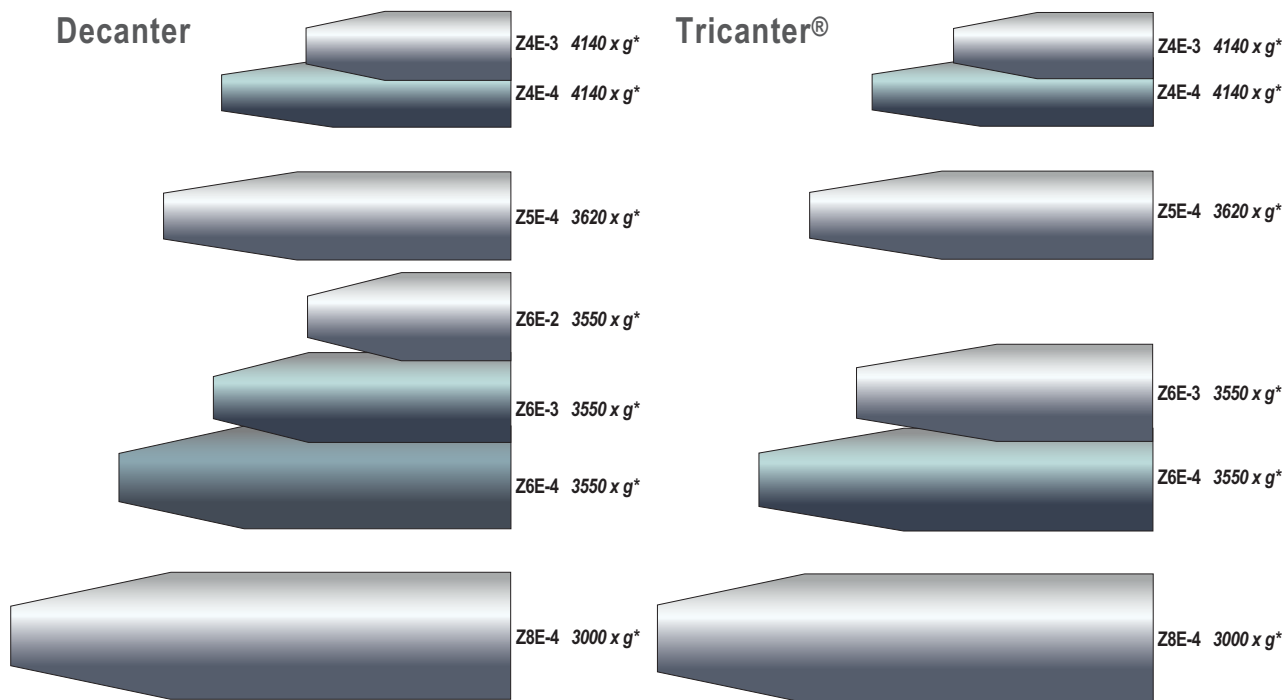

*Acceleration in g, depending on the temperature and the density of the product

TECHNICAL DATA OF FLOTTWEG DECANTERS AND TRICANTERS®				
Model	Z4E	Z5E	Z6E	Z8E
Dimensions* (L x W x H)	3500 x 1000 x 1200 mm 138 x 39 x 47 inch	4200 x 1300 x 1150 mm 165 x 51 x 45 inch	4800 x 1800 x 1250 mm 189 x 70 x 49 inch	6200 x 2000 x 1500 mm 244 x 78 x 59 inch
Gross weight*	3000 kg / 6600 lb	6200 kg / 13600 lb	9750 kg / 21500 lb	14150 kg / 31200 lb
Motor for bowl drive	45 kW / 60 hp	90 kW / 120 hp	132 kW / 177 hp	160 kW / 214 hp
Motor for scroll drive Flottweg Simp Drive®	15 kW / 20 hp	55 kW / 73 hp	110 kW / 147 hp	110 kW / 147 hp
Max. hydraulic capacity**	35 m³/h / 128 gpm	60 m³/h / 219 gpm	80 m³/h / 293 gpm	160 m³/h / 586 gpm

* The listed figures are to be understood as guidelines. Actual capacity will depend on the individual characteristics of the feed product.

** Data based on water, g-force depending on temperature, special material and product density. Data to be understood as guidelines.



Flottweg Separation Technology – Engineered For Your Success



Flottweg SE
Industriestraße 6-8
84137 Vilsbiburg
Deutschland (Germany)

Tel.: +49 8741 301-0
Fax: +49 8741 301-300

mail@flottweg.com
www.flottweg.com

REPRESENTATIVE