

SchuF 

***Engineered
Control
Valves***

for critical service

FETTEROLF

For over 60 years, SchuF's control valves have performed in the most arduous tasks in the Chemical, Petrochemical, Refining, Mining and Power industries. The valves are available with angle and in-line bodies. SchuF also offers a wide selection of speciality control valves ranging from multistage angle to multiport diverter valves. They include high pressure, high temperature let down valves, boiler feed and start up valves, disc and piston (ram) drain valves with contoured discs and rams, distributor control valves and bellows sealed valves.

Unrivalled experience - 3 phase slurries.

Our designs reduce or eliminate flashing in the valve before the seat, thus improving the life of body and trim. The disc opening design opens into the downstream vessel, ensuring that flashing takes place in an „infinite“ pipe preventing choking and reducing fluid speed. Over the past 20 years SchuF has perfected it's proprietary Cv calculation programme, which is unique in it's ability to handle 3 phase flow as well as high viscosity, non Newtonian fluids.

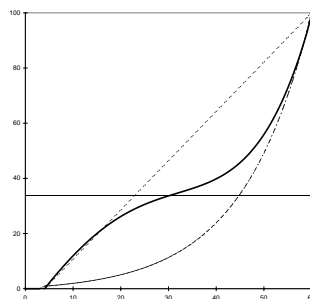

Patented Innovation

SchuF's patented x^3 bell curve as an alternative to linear, equal % or on /off characteristics, offers better controllability around operating conditions.

Industries served

Our valves are used as let down, level and flow control, three way mixing and distributive control for PTA, Polymers (PET & PBT, PU PVC etc), Coal and Heavy oil upgrading, gasification and liquefaction, salt & brine, Urea, metal slurries, steam handling and many more.

Features

The trim is single or multi-stage, with flow to open or close. On/off, hollow piston and cage trim are also available.



SchuF's strengths include flexibility of design and construction. We have produced control valves in all stainless steels, high Nickel alloys, Titanium and Zirkonium as well as PTFE and glass linings. SchuF uses special surface coatings and multiple spindle guiding to improve the resistance against vibrations and erosion. SchuF also offers solid Tungsten Carbide and Ceramic trims.



Most control valves come equipped with pneumatic diaphragm actuators (available in a fire-safe version) and piston actuators, while hydraulic and electric actuators are utilised for high pressures and specific control regimes.

CFD simulation

Extensive experience exists allowing detailed modelling to optimise body design.

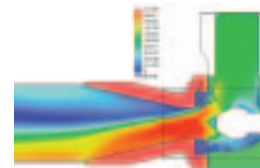

Detailed Information

Our main models are shown in special product fliers.

Severe Service Let Down Applications:

Pressure and Level Control, 74BS

Originally designed for PTA 3 phase slurry service these valves open into the downstream vessel to eliminate choking and cavitation. The accelerating body design prevents „in body“ flashing, the single piece disc and spindle with spindle protector stops metal fatigue and spindle bending. The valves are used in multi-stage reactor or crystalliser arrangements to control the level or pressure in the upstream unit. Optimal electrohydraulic actuators (below) eliminate sticking

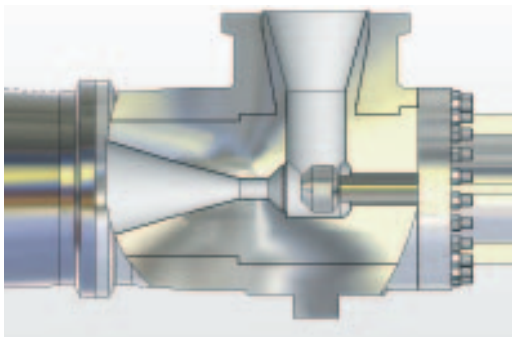
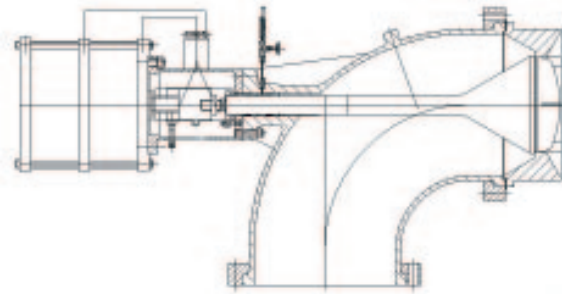
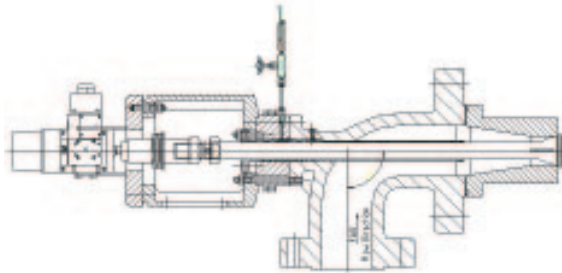
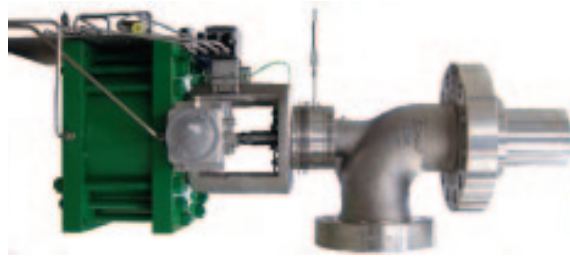

Let Down, 74CS

If piping considerations prohibit a disc opening valve, the 74CS offers a disc which opens into the valve. The effects of cavitation can be minimised by the use of suitable trims (e.g. stellites, ceramics and special grain Tungsten Carbides), optimised trim design with easy to replace trim and SchuF's impulse control modus. Examples include PTA recycling (above) and direct coal liquefaction where the residue is let down progressively from pressures over 200 bar in the HHP separator to vacuum in the distillation unit at temperatures up to 500°C.

Multistage Let Down, 74MS

Multi-stage let-down distributes the pressure across two or more stages, enhancing the life of the trim. These valves are not suitable for high solid content or large particles as these can clog the flow path in the seat. In the cracking process unconverted oil or residue is depressurised through a multi-stage control valve in which the vapour fraction flashes out according to its properties. This valve may have inlet conditions of 100°C/ 100~200 bar. A special material venturi is available after the last seat if cavitation is unavoidable.

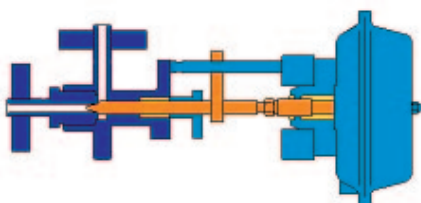
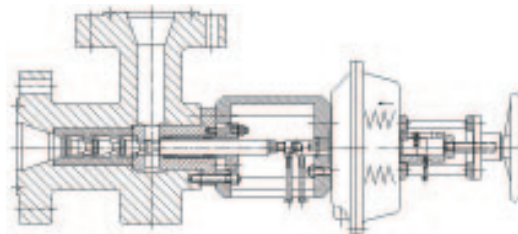

High Pressure Angle Valve for Urea

High pressure (200bar working pressure at 200°C) are extensively used in Urea plants. SchuF delivers angle valves for this service with manual or pneumatic actuation, with on/off or control trim, as reactor or angle valves.

Engineered Control Valve Applications:

In-line Globe Control Valve, 72BS

SchuF supplies many in-line control valves featuring stuffing box or bellows seal, mostly with special materials or trim such as one with a noise reducing cage.

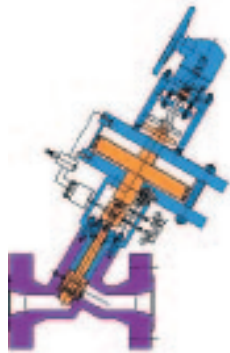
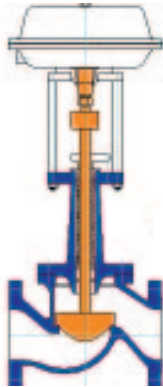

Y-Globe Control Valve, 50SR

The drawback of a globe control valve is the low capacity and high pressure resistance. The ball type control valves have a limited life due to the ball's rotation wearing out the seal and need large actuators to overcome the high torques. The y-globe valve's flow characteristics come close to those of a ball valve, and allow the use of smaller valves compared to a globe valve. It's proven metal to metal seat guarantees a longer leak tight sealing performance than the ball valve with smaller actuators. A typical application is temperature control for a heat exchanger in a hydrocracker.

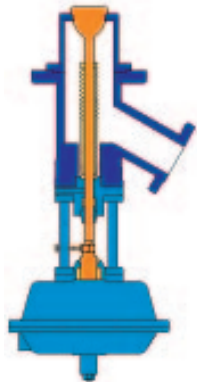

Vessel Drain Control

Normal flush mounted disc or ram bottom valves can be customised and fitted with control contours.

Cage Control Valve

An angle valve with a class VI shutoff and a cage with stepped Cv that offers good controllability at both very low and high flowrates is used here as an emergency vent control for Hydrogen. The class VI shut off is especially important for valuable commodities like hydrogen.

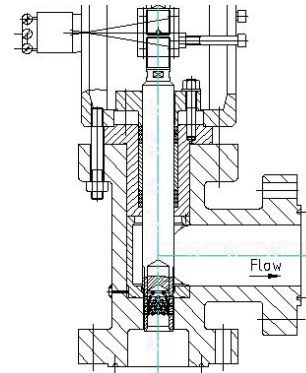

Solid Feed Control Valve

SchuF supplies control valves to control the flow of dry powder feed carried by gas even with high delta P. This is an example of gas carried coal feed flow control valve, designed for Shell, where control of the flow is a critical and complex task. The coal must not settle in the valve and so certain minimum speeds of flow must be maintained. At these speeds the coal is abrasive and so special materials such as tungsten carbide must be used to produce the valve.

Pump Recirculation Valve

These valves protect the pump from overheating. When required they create „a closed loop“ for the pumps by feeding the min required flow back to the pump inlet. Applications include sea-water on an FPSO, C4 in a refinery, oil in a cracker, PTA slurry and coal slurry in a liquefaction plant.

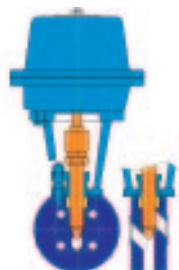

Wafer Type Control Valve

These valves feature short as built lengths, yet they maintain a high flexibility with an extremely wide range of Cv's. Their short lengths mean they can be flanged between two pipeline flanges, even when fully jacketed. The examples shown here are used in the production of nylon and polycarbonates.



Steam and related Applications:

Steam Conditioning Valve, 74DU

Steam control valves control the pressure and temperature of steam. Steam is generated at high pressures and temperatures to ensure high turbine efficiencies. The movement of the main stem regulates the pressure, the addition of water through the stem desuperheats the steam. The further the valve opens the greater the product throughput and the more cooling water is added.

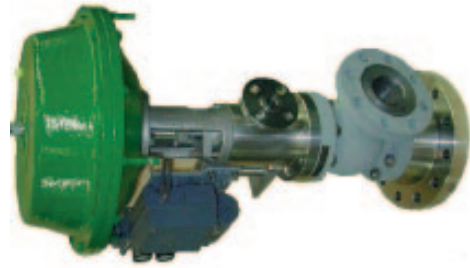
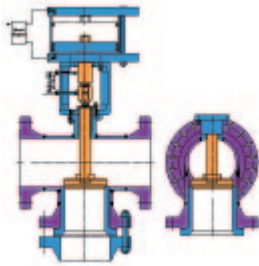

Waste Heat Recovery Valve

This valve is a full bore 3-way steam mixing valve. Hot flue gas from the melting furnaces are used to turn water into steam by boilers. Steam from these waste heat recovery boilers are transported and combined through a piping network to supply steam at high pressure, which is then passed through an existing turbine to generate electricity. The 3-way valve serves as a mixing isolation valve in the main steam header.

Start Up Valve for Steam Generation

Among the uses for the energy inherent in the high temperature flue gases from the furnaces of a Naphtha cracker is the generation of steam. A normal control valve regulates the usage of steam, once the system is at pressure. In order to get the system up to pressure a valve must handle a small flow across the full pressure drop (over 120 bar). The standard control valve cannot handle the efficiently, so a parallel start-up valve is used until the system is up to operating pressure.

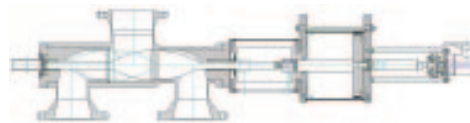
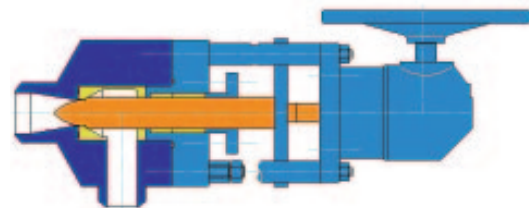

Gasoline Mixing Control Valve

This is an example of a gasoline mixing valve used in the oil refining industry in hydrocracker control. It controls the mixing of gasoline from a fluid catalytic cracking unit (which is then passed through a heat exchanger) with crude gasoline. It usually has a linear control contour.

Delayed Coking Lift Plug Switching Control Valve

Delayed coking is a semi-continuous thermal cracking process. After being heated in a coke furnace the coke feed (a liquid-vapour combination) is passed through a coke drum. Delayed cokers are designed as pairs so that one can be cleaned with the other remaining in operation. A four way switching valve is required here to allow coke feed into whichever coke drum is active. During start up, shut down or an emergency, the valve can also bypass both drums, through the third outlet. The lift plug switching valve uses much less steam than a ball switching valve, shows no gaps between plug and body, minimises spare parts and maintenance time and cost. It can be supplied as a complete unit with isolation valves and control panel.

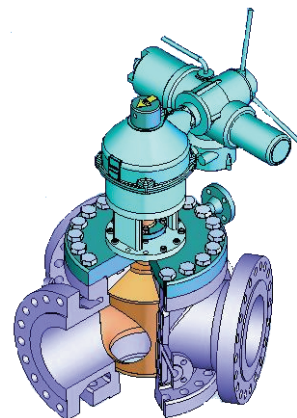

Monomer & Polymer Control Valve Applications:

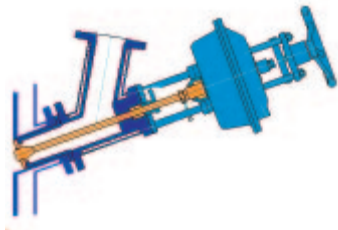

Monomer Feed Valve

Disc control valves are used to regulate the level in PVC reactors. For PET, PBT etc, control valves are used to regulate the flow into the esterification and polymerisation reactors. For vacuum service, bellows are generally used. As they are susceptible to failure in a crystallising and polymerising environment, SchuF recommends external bellows. In these applications, weld-lip gaskets can further enhance the vacuum safety of the system.

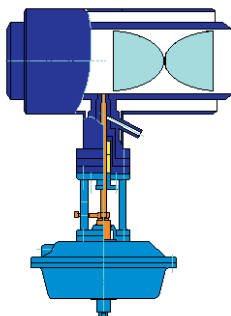
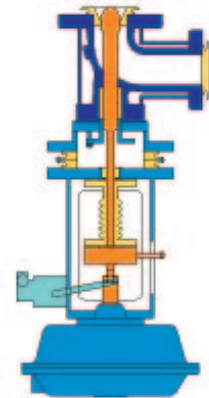

Polymer Additives Injection Valve

These valves were developed to allow continuous polymer plants producing, for example PET, to customise their product. These valves allow small amounts of additives and catalysts, such as Titanium dioxide to be injected into the line and distributed evenly into the polymer stream. For accurate and uniform injection of very small quantities, an automated high frequency, minimal volume valve is used.

Polymer Flow Control Valve

In direct spinning polymer plants a chip line is often added to take the overflow. It is important that the pressure at the spinning heads is constant to ensure long, even strands. In order to ensure this the flow to the chipper line is varied using a flow control valve. In the different examples shown here either a traditional linear control contoured disc as a branch valve, or a rotating ram with special contoured tip or a variable restriction length is used. These valves can be combined with multiport diverter valves to control the pressure in many different lines.

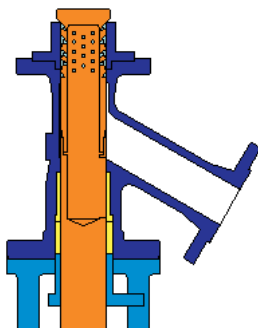
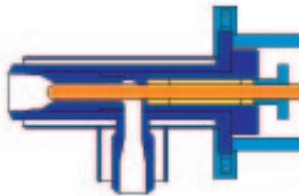

Injection, Stripping & Spray Rinse Valve

In many processes unwanted impurities or remnants (such as unpolymerised monomers in PVC and Polyurethanes or Solvents in Paints and Coating suspensions) are stripped from the batch by the injection of steam. The ram tip is specially adapted to each vessel as well as the required flow conditions, optimising the spray pattern.

Spray rinse valve clean the reactor after each batch. This is especially useful in closed reactor technology.



General Specifications:

Available valves

Angle, line, wafer, T-piece, multiport
Inlet/outlet angles of 180, 90, 60 or 45°

Flow Coefficients

single stage 1 to 5000
multi-stage 1 to 350, cage 1 to 300

Flow Characteristic

Linear, Equal percentage, x³ or bell curve

Flow Direction

Flow to open or close

Positioner Selection

As per customer specification.
E.g. Siemens PS2 Smart, SMC i/p positioner

Actuator Selection

- PM multi-spring diaphragm actuator in st.st., C.St. or Aluminium casing
- PD double acting cylinder actuator in steel casing
- PE single acting cylinder actuator in steel casing
- EM electric actuator
- HY hydraulic actuator
- EH electro-hydraulic
- KU bevel gear
- LM pneumatic motor

Calculating required Cv

SchuF calculates the requirement for the three phases separately. For liquids we first check for cavitation. Cavitation will occur if $K_c = 0.8 * (P_1 - P_v)$ is less

than $c = P_1 - P_v * \left(0.96 - 0.28 \sqrt{\frac{P_v}{P_c}} \right)$,
if $c > P_1 - P_v$ then c should be used instead of $P_1 - P_v$ in the formula for liquids:

$$K_{vf} = Q * \sqrt{\frac{\rho}{(1000 * \Delta P)}} = \frac{W}{\sqrt{(\rho * 1000 * \Delta P)}}$$

For Gases we use:

$$K_{vg} = \left(\frac{Q}{2600} \right) * \sqrt{\left(\frac{T * Z * M_1}{\Delta P * P_1} \right)} = \left(\frac{W}{110} \right) * \sqrt{\left(\frac{T * Z_1}{\Delta P * P_1 * M} \right)}$$

and for steam:

$$K_{vw} = \left(\frac{W}{32} \right) * \sqrt{\left(\frac{v}{\Delta P} \right)}$$

Note that for gas or liquid use $v = 1/2$ as a max.

In all three cases note that $C_v = 1.156 * K_v$;

We now add to get total required Cv:

$$C_v = C_{vf} + C_{vg} + C_{vw}$$

Note that these formulas may give nonsensical results in case of boiling liquids. SchuF has developed a technique to modify and eliminate this phenomena.

Valve sizes

1/2" to 36" (DIN 15 to 900mm)

Rating

Class 150 to 2500# ASME, DIN or JIS
Butt weld ends
Flanged ends in RF, RTJ, LR or LM/LF style
Hub and clamps from Grayloc or Securamax

Inlet temperatures and pressures

Consistent with applicable rating according to ASME B16.34

Materials

Body

WCB, WC6, WC9, Cr-Mo Steel
CF3, CF3M, CF8, CF8C, CF8M, CG8M
Duplex, Incoloy, Inconel, Hastelloy & Titanium

Lining / Sleeves

Glass, PTFE
Colmonoy, Stellite, Chroming
Tungsten Carbide, TiN, Canadising

Trim

420, 316, 316L, 321 st.st.
SAF 2205, Inconel, Titanium
Stellite, Tungsten Carbide, Ceramics

Jacketing

Full or partial, C.St., st.st. or Titanium

Table of Cvs available:

Valve Size	Seat diam	Cvs min	Cvs max
1"-1 1/2" DN 25-40	3-5	0,1	1
	6-10	1	6
	10-15	6	10
2" DN 50	15-20	10	20
	20-40	20	50
	50-75	60	240
3" DN 80	70-90	140	300
	90-135	180	500
4" DN 100	100-175	250	1000
	175-200	500	1250
6" DN 150	200-300	750	3500
	300-400	2700	5000
8" DN 200			
10" DN 250			
12" DN 300			
14" DN 350			
16" DN 400			
18" DN 450			
20" DN 500			
24" DN 600			
36" DN 900			

In this general brochure we hope to present a small cross-section of the type of products we have already supplied. Please do not feel constrained - we can supply you with many more special designs. *Chances are that we may have already solved your problem!*



*Fetterolf Corporation, Inc.
USA
info@fetterolfvalves.com*

*SchuF USA
info@schuf.us*



SchuF Valve Technology, GmbH

Ireland

sales@schuf.ie



*SchuF Armaturen
und Apparatebau GmbH*

*SchuF Chemieventile
Vertriebs GmbH & Co KG
Germany*

verkauf@schuf.de



Fetterolf SchuF do Brasil Ltda

Brazil

fbvendas@fetterolf.com.br

Your Local Agent



SchuF Specialty Valves India Pvt. Ltd.

India

sales@schuf-india.com