

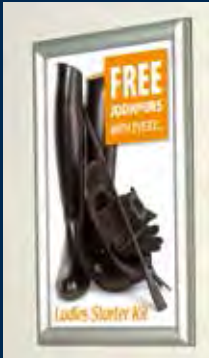

spring **2014**
CATALOGUE



display

signage

café banners



café banners and Q management

pg 77



indoor signage

pg 68

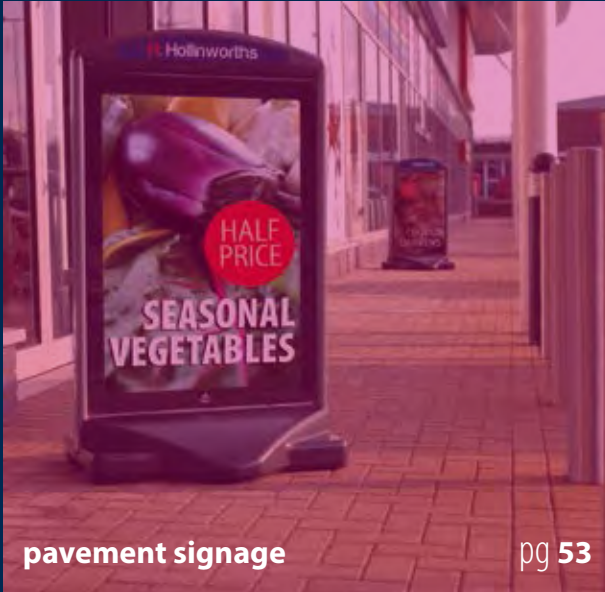

pavement signage

pg 53

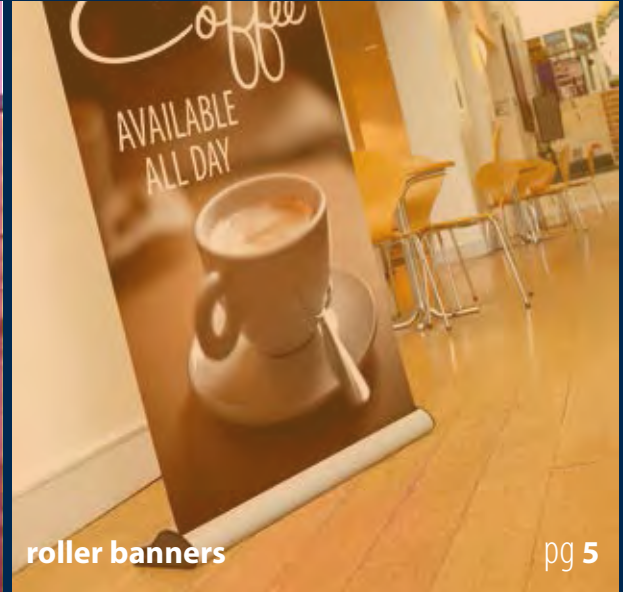

roller banners

pg 5



carry equipment and accessories

pg 49

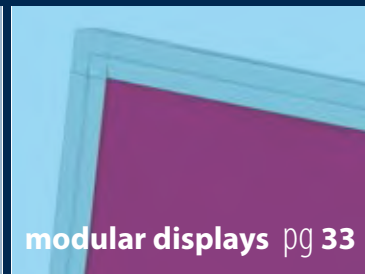

modular displays



lighting

pg 47

hello from



Welcome to the new Spring 2014 catalogue.

warranty

All products are covered by a 2-year warranty unless otherwise stated.



Border Digital Ltd
Nutbourne Business Centre
Main Road, Nutbourne
Chichester, West Sussex. PO18 8RL

01243 377721 sales@border-digital.co.uk

contents

roller banners 5

atom.....	7
zeta.....	8
neo.....	9
genie.....	10
sigma.....	11
organic.....	12
sidewinder.....	13
omega.....	15

static banners 16

cobra.....	17
illusion.....	18

outdoor banners 19

typhoon.....	21
polar.....	22
cyclone.....	23
outdoor a banner.....	24
vision.....	25

pop-up systems 26

element.....	27
advantage - curved.....	29
advantage - straight.....	31

modular displays 33

fusion rapid.....	34
fusion versa.....	35
fusion accessories.....	36
panel and pole kits.....	38
folding panel kits.....	39

literature stands 41

media compact portrait.....	42
media 4 deluxe.....	43

in-store promotion units 44

in-store promotion unit.....	45
wheeled in-store promotion unit.....	46

lighting 47

carry equipment and accessories 49

pavement signage 53

sign wedge.....	55
folding swing sign.....	56
classic.....	57
switch.....	58
aquabase.....	59
aquabase swap.....	60
a-frame.....	61
traditional chalk board.....	62
rounded chalk board.....	63

forecourt signage 64

icon.....	66
H2O swingmaster.....	67

indoor signage 68

gripframes.....	69
information points.....	71
telescopic information points.....	72
iPad holder.....	73
lightboxes.....	74
poster snappers.....	75

café banners and Q management 77

primo original.....	79
primo wrap.....	81
medio original.....	83
medio wrap.....	85
espresso.....	87
q management.....	90

product accessories 91

boxed weights and dimensions 92

additional information 94

BANNERSTANDS

POP-UP SYSTEMS

MODULAR DISPLAYS

LITERATURE STANDS AND PROMOTION UNITS

LIGHTING AND CARRY EQUIPMENT



display

rollerbanners

QUICK REFERENCE GUIDE



For more information visit
www.thedisplaydirectory.com



PRODUCT SELECTOR

PRICE INDICATOR	atom	zeta	neo	genie
GRAPHIC WIDTH	800 / 850mm	800mm	600 / 800 / 850 / 1000 / 1200 / 1500mm	800 / 1000mm
HANGER TYPE	Gripping	Mechanical	Gripping	Gripping
POLE TYPE	3 part bungee	Telescopic	3 part bungee* *600mm pole has a 4 part bungee	3 part bungee

PAGE 7

PAGE 8

PAGE 9

PAGE 10



sigma



800 / 1000mm

Mechanical

Telescopic

PAGE 11



organic



850mm

Self-adhesive

Push fit

PAGE 12



sidewinder



600 / 800 / 1000 / 1200 / 1500mm

Self-adhesive

4 part bungee

PAGE 13



omega



780mm [fabric]

N/A

3 part bungee

PAGE 15

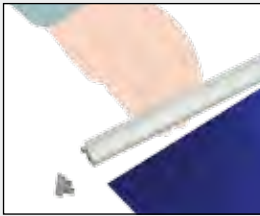

Sure grip hanger.



Fixed height bungeed pole set.



Two twist out feet.

GRAPHIC PANEL SIZES

- **Finished size:**
2200 x 800/850mm
[inc. 200mm bleed]
- **Visual area:**
1990 x 800/850mm
[top 10mm of graphic
hidden by the top
gripper rail]

atom



SCAN ME FOR WEBPAGE

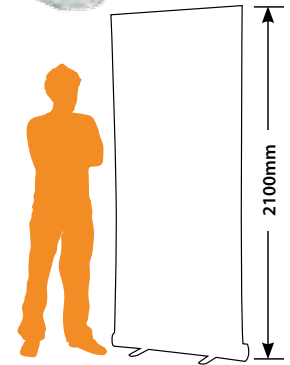

800mm footprint: 815 [w] x 380 [d]mm

850mm footprint: 865 [w] x 380 [d]mm



CODE	DESCRIPTION
91756	Atom 800mm
91430	Atom 850mm

features

- Entry level roller banner
- 800mm and 850mm widths, single-sided
- Visible graphic height 1990mm
- Sure grip, slim profile, gripping hanger
- Strong, fixed height, 3 part bungeed pole set
- Two twist out feet
- Carry bag included
- Unbranded instructions and packaging

For our lighting range see pages 47-48.

For more product information visit www.thedisplaydirectory.com

zeta

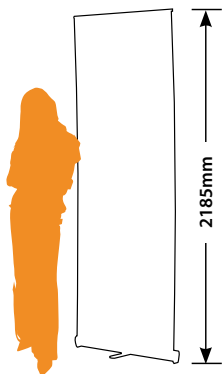

Footprint: 810 [w] x 320 [d]mm



SCAN ME FOR WEBPAGE



Adjustable telescopic pole set.



Mechanical style top hanger.



Can be used as a desktop system.

CODE	DESCRIPTION
91080	Zeta 800mm

features

- Budget roller banner
- 800mm wide, single-sided
- Visible graphic height to maximum 2090mm
- Mechanical style top hanger
- Telescopic poles, adjust from 730mm to 2100mm
- Twist out foot
- Carry bag included
- Individually boxed

For our lighting range see pages 47-48.

For more product information visit www.thedisplaydirectory.com

GRAPHIC PANEL SIZES

- **Finished size:**
2300 x 800mm
[inc. 200mm bleed]
- **Visual area:**
2090 x 800mm
[top 10mm of graphic hidden by the mechanical hanger]



Thicker end cap.



Padded bag.



Individually boxed.

GRAPHIC PANEL SIZES

- **Finished size:**
2200 x 600/800/850/1000/
1200/1500mm
[inc. 200mm bleed]
- **Visual area:**
1990 x 600/800/850/1000/
1200/1500mm
[top 10mm of graphic hidden
by the top gripper rail]

neo

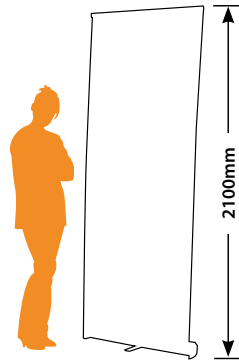

SCAN ME FOR WEBPAGE



600mm footprint: 615 [w] x 380 [d]mm
800mm footprint: 815 [w] x 380 [d]mm
850mm footprint: 865 [w] x 380 [d]mm

1000mm footprint: 1015 [w] x 380 [d]mm
1200mm footprint: 1215 [w] x 380 [d]mm
1500mm footprint: 1515 [w] x 380 [d]mm

CODE	DESCRIPTION
91825	Neo 600mm wide
91754	Neo 800mm wide
91755	Neo 850mm wide
91826	Neo 1000mm wide
91827	Neo 1200mm wide
91828	Neo 1500mm wide

features

- Thicker aluminium extrusions for main unit and feet
- Sure grip, slim profile, gripping hanger
- Strong, fixed height, 3 part bungeed pole set*
- Single-sided, available in 6 widths
- Two twist out feet
- Unbranded instructions and packaging

*For our lighting range see pages 47-48. *Pole for 600mm unit is a 4 part bungee.*

For more product information visit www.thedisplaydirectory.com

genie



SCAN ME FOR WEBPAGE

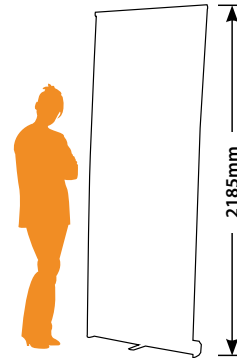

800mm footprint: 815 [w] x 320 [d]mm
1000mm footprint: 1015 [w] x 320 [d]mm

CODE	DESCRIPTION
30241	Genie 800mm wide
90843	Genie 1000mm wide

features

- 800mm and 1000mm widths
- Single-sided
- Visible graphic height 2100mm
- Fixed height bungeed pole set
- Quick change graphic facility
- Padded carry bag included

For our lighting range see pages 47-48.

For more product information visit www.thedisplaydirectory.com



Quick change graphic facility.



Available in 800mm and 1000mm widths.

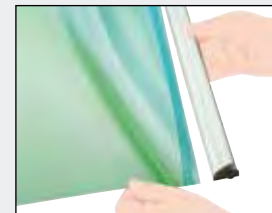

Gripper style top hanger.

GRAPHIC PANEL SIZES

- **Finished size:**
2315 x 800/1000mm
[inc. 200mm bleed]
- **Visual area:**
2100 x 800/1000mm
[top 15mm of graphic
hidden by the
top gripper rail]



Telescopic marked pole set.



Can be used as a desktop system.



Mechanical hanger.

GRAPHIC PANEL SIZES

- **Finished size:**
2300 x 800/1000mm
[inc. 200mm bleed]
- **Visual area:**
2090 x 800/1000mm
[top 10mm of graphic
hidden by the
mechanical hanger]

sigma

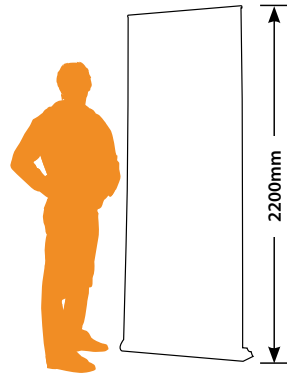

800mm footprint: 820 [w] x 180 [d]mm
1000mm footprint: 1020 [w] x 180 [d]mm



SCAN ME FOR WEBPAGE



CODE	DESCRIPTION
91444	Sigma 800mm
91739	Sigma 1000mm

features

- 800 and 1000mm widths, single-sided
- Telescopic poles adjust from 730 - 2100mm
- Mechanical style top hanger
- Quick change graphic facility
- Weighted anti-slip base
- Padded carry bag included

For our lighting range see pages 47-48.

For more product information visit www.thedisplaydirectory.com

organic

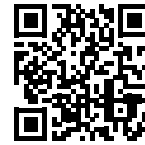

SCAN ME FOR WEBPAGE

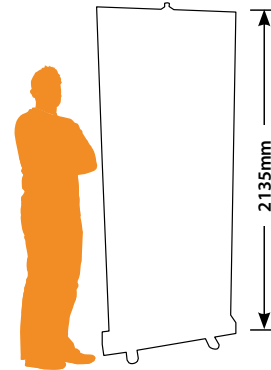

Footprint: 920 [w] x 320 [d]mm



CODE	DESCRIPTION
91599	Organic 850mm

features

- 850mm wide, single-sided
- Visible graphic height 1985mm
- Fixed height three piece pole set
- Self-adhesive bamboo top hanger
- Padded carry bag included
- Two twist out feet

For our lighting range see pages 47-48.

For more product information visit www.thedisplaydirectory.com



Bamboo casing and two twist out feet.



Hanger attachment on pole.

GRAPHIC PANEL SIZES

- **Finished size:**
2200 x 850mm
[inc. 200mm bleed]
- **Visual area:**
1985 x 850mm
[15mm hidden by the top hanger]



Integral bungeed pole set.



Adjustable tensioning [if required].



Available in single or double-sided options.

GRAPHIC PANEL SIZES

- **Finished size:**
2300 x 600/800/1000/
1200/1500mm
[inc. 200mm bleed]
- **Visual area:**
2160 x 600/800/1000/
1200/1500mm

sidewinder



SCAN ME FOR WEBPAGE

features and benefits

- Never lose your pole set again with Sidewinder's integral pole design
- A size option to suit any location. A truly versatile range of 5 widths – 600mm, 800mm, 1000mm, 1200mm and 1500mm wide. All sizes available as either single or double-sided
- Unique full graphic appearance - your message is the only thing you see when the system is assembled
- A deluxe carry bag with 30mm thick padded ends means the Sidewinder can be transported regularly without any worry of damage
- Self-adhesive top hanger
- The graphic can be changed quickly and easily due to the hook and loop fastener fixing method
- Fixed height poles allow the graphic to be rapidly set-up to the correct height every time
- The patented adjustable ratchet mechanism enables the graphic tension to be adjusted to suit each graphic substrate (if required)
- Anti-slip base



For our lighting range see pages 47-48.

For more product information visit www.thedisplaydirectory.com



UK Patent No. WO 02/057588
No. PCT/GB02/00129 in USA

CODE	DESCRIPTION
463010	Sidewinder 600mm / single-sided
463011	Sidewinder 800mm / single-sided
463012	Sidewinder 1000mm / single-sided
463013	Sidewinder 1200mm / single-sided
463014	Sidewinder 1500mm / single-sided
463020	Sidewinder 600mm / double-sided
463021	Sidewinder 800mm / double-sided
463022	Sidewinder 1000mm / double-sided
463023	Sidewinder 1200mm / double-sided
463024	Sidewinder 1500mm / double-sided

PLEASE NOTE: Unattached pole set on 600mm version.

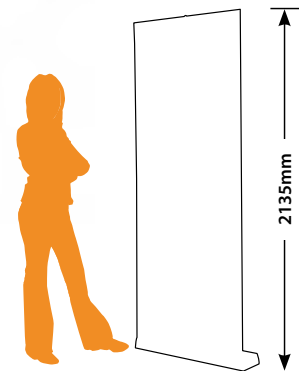

600mm footprint:
617 [w] x 165 [d]mm
800mm footprint:
817 [w] x 165 [d]mm
1000mm footprint:
1017 [w] x 165 [d]mm
1200mm footprint:
1217 [w] x 165 [d]mm
1500mm footprint:
1517 [w] x 165 [d]mm



Customisable end trims.



Velcro® friendly fabric panels.

FABRIC COLOUR OPTIONS:



Blue

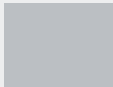

Grey



Fabric is manufactured from recycled materials.

FABRIC PANEL SIZES

- Visible fabric area: 2000 x 780mm

omega

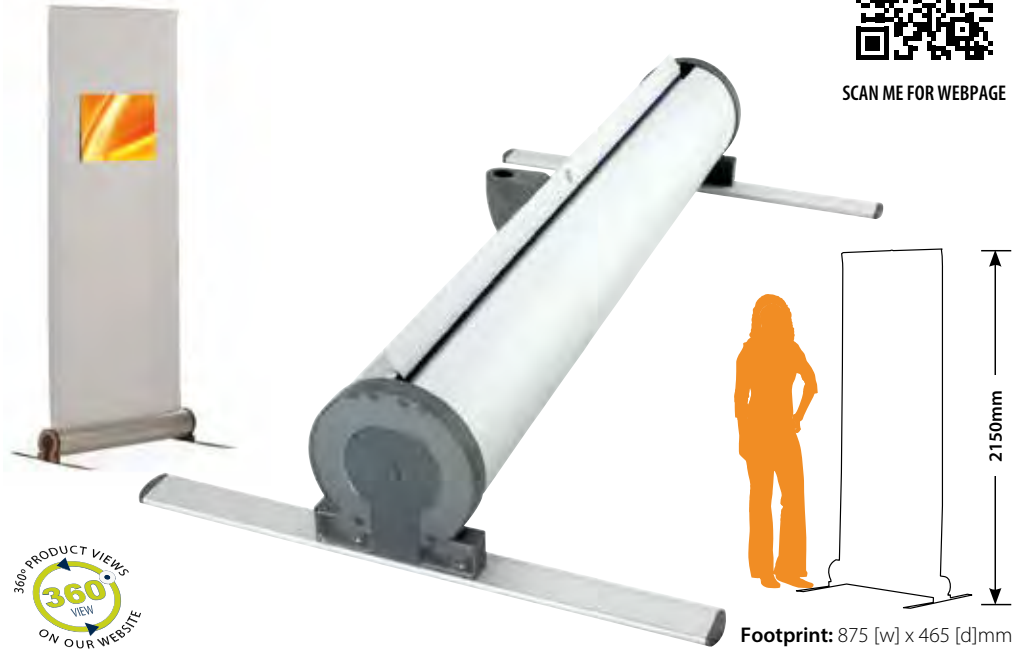

SCAN ME FOR WEBPAGE



CODE	DESCRIPTION
30225/1	Omega fabric 780mm / grey fabric
30225/4	Omega fabric 780mm / blue fabric

features

- 780mm wide, single-sided
- Visible fabric height 2000mm
- Choice of two Velcro® friendly fabric colours (grey or blue)
- Fixed height bungeed pole set
- Customisable end trims
- Carry bag included

For our lighting range see pages 47-48.

For more product information visit www.thedisplaydirectory.com

staticbanners

QUICK REFERENCE GUIDE



For more information visit
www.thedisplaydirectory.com

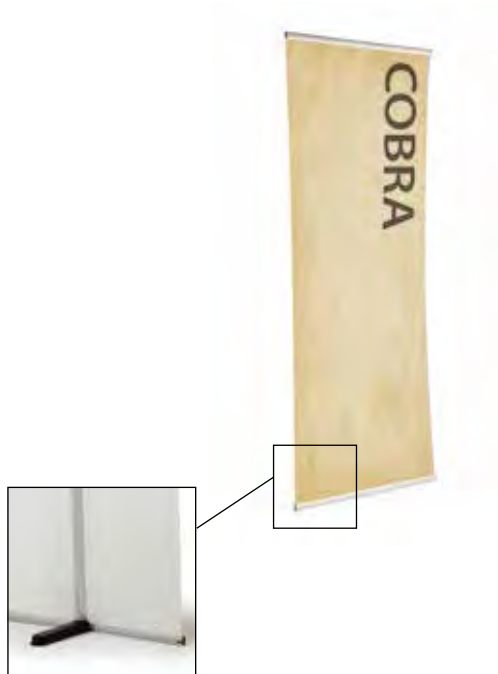

cobra

PRICE INDICIATOR	£
VISUAL GRAPHIC AREA	2072 x 800mm
GRAPHIC ATTACHMENT METHOD	Gripping hangers
FOOTPRINT	806 [w] x 300 [d]mm

PAGE 17

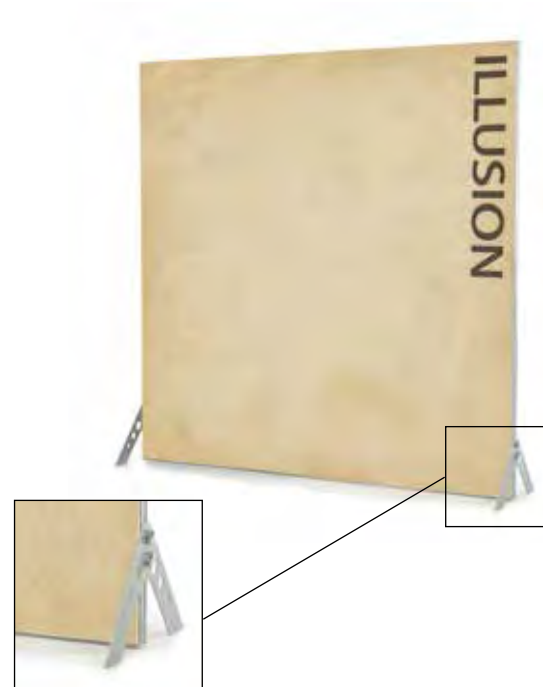

illusion

PRICE INDICIATOR	£ £ £ £
VISUAL GRAPHIC AREA	2000 x 2000mm
GRAPHIC ATTACHMENT METHOD	Silicone strip
FOOTPRINT	2040 [w] x 495 [d]mm

PAGE 18



Quick and easy graphic change with the gripper style hanger.



Adjustable telescopic pole set.



Weighted base for added stability.

GRAPHIC PANEL SIZES

- **Finished size:**
2100 x 800mm
- **Visual area:**
2072 x 800mm
[14mm hidden at the top and bottom by the gripper hangers]

cobra

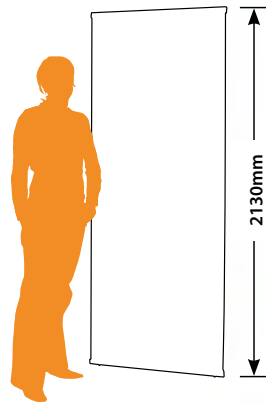

Footprint: 806 [w] x 300 [d]mm



SCAN ME FOR WEBPAGE



CODE	DESCRIPTION
91065	Cobra 800mm

features

- 800mm wide, single-sided
- Visible graphic height adjusts from 900mm up to 2000mm
- Adjustable telescopic pole set
- Gripper style top and bottom hangers
- Lightweight carry box included
- Can be used as a desktop system
- Assembled weight 2.0kg

For our lighting range see pages 47-48.

For more product information visit www.thedisplaydirectory.com

illusion

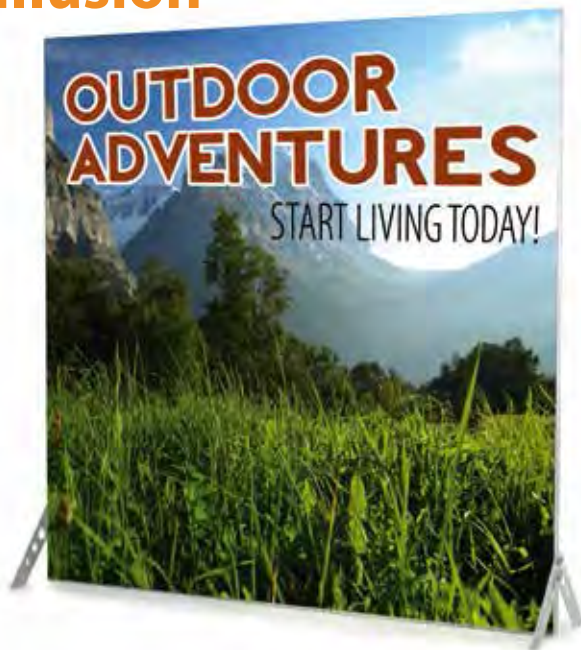

SCAN ME FOR WEBPAGE

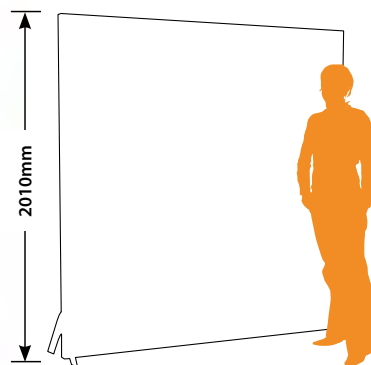

Footprint: 2040 [w] x 495 [d]mm

CODE	DESCRIPTION
91645	Illusion 2000mm
91657	Replacement graphic/ double-sided conversion silicone strip

features

- Visible graphic area 2000 x 2000mm
- Single-sided as standard
- Turn a single-sided kit into a double-sided by adding extra silicone strip
- Heavy steel triangular feet for stability
- Kit includes: frame, steel weighted feet and silicone graphic strip (enough for one graphic)
- Ideal for use with fabric graphics, recommended substrate – matt knitted polyester

For our lighting range see pages 47-48.

For more product information visit www.thedisplaydirectory.com



Push fit frame construction.



Corners assemble easily with an Allen key [supplied with kit].



The silicone graphic strip sits tightly in the frame. Graphic stretches into place.

GRAPHIC PANEL SIZES

- **Finished size:**
2000 x 2000mm
- **Visual area:**
2000 x 2000mm

outdoor**banners**

QUICK REFERENCE GUIDE



For more information visit
www.thedisplaydirectory.com

PRODUCT SELECTOR

PRICE INDICATOR

WEIGHT [WITH / WITHOUT WATER]

HEIGHT

FOOTPRINT



typhoon



15kg / 41kg

2170mm

1000 [w] x 780 [d]mm

PAGE 21



polar



4.3kg / 22.3kg

1350 - 2150mm [telescopic]

650 - 800mm [w] x 400 [d]mm
 [adjustable width]

PAGE 22



cyclone



2.7kg / 15.2kg

1990mm

800 [w] x 540 [d]mm

PAGE 23



outdoor A-banner



2000mm = 3.8kg / 3000mm = 5.5kg

960mm

2000mm = 2200 [w] x 650 [d]mm / 3000mm = 3190 [w] x 650 [d]mm

PAGE 24



vision



2000mm single-sided = 5.5kg / 3000mm single-sided = 7.2kg
2000mm double-sided = 8.5kg / 3000mm double-sided = 12.1kg

1100mm

2000mm = 2140 [w] x 990 [d]mm / 3000mm = 3160 [w] x 990 [d]mm

PAGE 25



Water/sand filled base with twist out foot for added stability.



Pull handle and integral wheels for easy transportation.



Slide-in self-adhesive hanger.

GRAPHIC PANEL SIZES

- **Finished size:**
2150 x 800mm
[inc. 100mm bleed]
- **Visual area:**
2000 x 800mm
[50mm hidden by the top gripper hanger]

typhoon

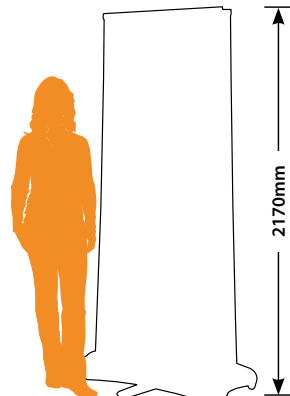

Footprint: 1000 [w] x 780 [d]mm



SCAN ME FOR WEBPAGE



CODE	DESCRIPTION
91634	Typhoon 800mm outdoor roller bannerstand

features

- 800mm wide, single or double-sided outdoor roller banner
- Choice of visual graphic height either 1470 or 2000mm
- Wheeled base for easy manoeuvrability
- Two slide-in self-adhesive top hangers supplied as standard
- 26 litre base capacity
- Carry bag included

I Graphics suitable for outdoor use are recommended.

For more product information visit www.thedisplaydirectory.com

polar

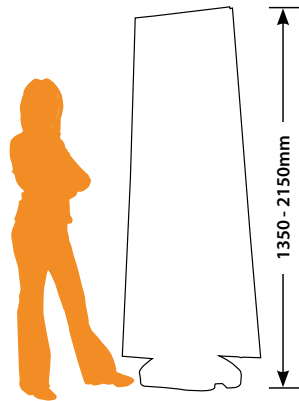

Footprint: 650 - 800 [w] x 400 [d]mm

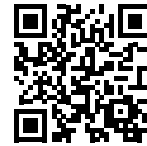

SCAN ME FOR WEBPAGE



CODE	DESCRIPTION
91240	Polar outdoor bannerstand
91282	Polar weighted base ring
91281	Polar carry bag set

features

- Adjustable graphic width from 650 to 800mm
- Adjustable graphic height from 1200 to 2000mm
- Single or double-sided option as standard
- Ideally suited to eyeletted PVC or mesh substrates
- 18 litre base capacity
- Optional carry bag set available
- Optional weighted base ring (10 litre capacity)

I Graphics suitable for outdoor use are recommended.

For more product information visit www.thedisplaydirectory.com



Adjustable telescopic pole set.



Adjustable width graphic hangers.



Moulded plastic base can be filled with water or sand for extra stability. Optional weighted base ring is available.

GRAPHIC PANEL SIZES

- **Finished size:**
1200-2000 x 650-800mm
- **Visual area:**
1200-2000 x 650-800mm



Moulded base can be filled with water or sand for added stability.



Tensioned carbon rod assembly.



Moulded hooks allow easy graphic attachment.

GRAPHIC PANEL SIZES

- **Finished size:**
1800 x 800mm
- **Visual area:**
1800 x 800mm

cyclone

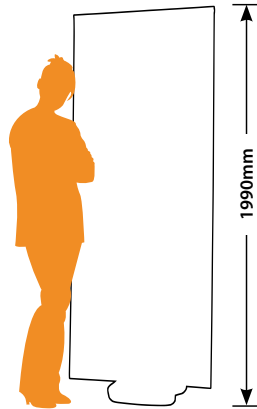

Footprint: 800 [w] x 540 [d]mm



SCAN ME FOR WEBPAGE



CODE	DESCRIPTION
91558	Cyclone 800mm outdoor bannerstand
91281	Cyclone carry bag set

features

- 800mm wide, single-sided
- Visual graphic height 1800mm
- Ideally suited to eyeletted PVC or mesh substrates
- Tensioned carbon rods
- 12 litre base capacity
- Optional carry bag set available

I Graphics suitable for outdoor use are recommended.

For more product information visit www.thedisplaydirectory.com

outdoor A-banner



SCAN ME FOR WEBPAGE

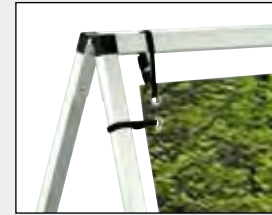

Push fit parts give quick and easy assembly.



Ground pegs supplied as standard for use in soft ground.

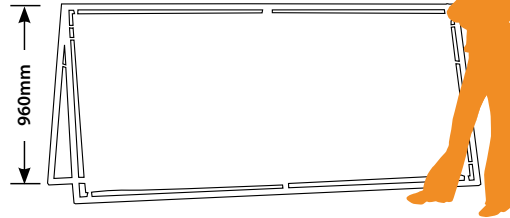

2m footprint: 2200 [w] x 650 [d]mm

3m footprint: 3190 [w] x 650 [d]mm

CODE	DESCRIPTION
91716	Outdoor A-banner 2m / single/double-sided
91717	Outdoor A-banner 3m / single/double-sided

features

- Two widths available – 2m and 3m
- 2m and 3m widths can be used as either single or double-sided
- Graphic height – 860mm
- Graphic width – 2m - 2060mm or 3m - 3050mm
- Push fit assembly
- Flexible bungee cord graphic attachment
- Ideally suited to eyeletted PVC or mesh substrates
- Carry bag included

I Graphics suitable for outdoor use are recommended.

For more product information visit www.thedisplaydirectory.com

GRAPHIC PANEL SIZES

- **Finished size:**
2060/3050 x 860mm
- **Visual area:**
2060/3050 x 860mm



Robust screw fit assembly ideal for outdoor environments.



Ground pegs supplied as standard for use in soft ground.

vision



SCAN ME FOR WEBPAGE

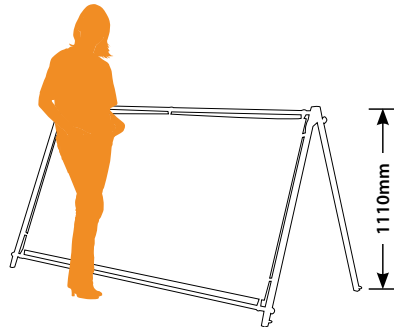

2m footprint: 2140 [w] x 990 [d]mm

3m footprint: 3160 [w] x 990 [d]mm

CODE	DESCRIPTION
30289	Vision 2000mm / single-sided
30331	Vision 2000mm / double-sided
30320	Vision 3000mm / single-sided
30351	Vision 3000mm / double-sided
91778	Vision carry Bag

features

- Two widths available - 2m and 3m
- 2m and 3m wide available in both single or double-sided
- Graphic height - 1000mm
- Flexible bungee cord graphic attachment
- Screw fit, horizontal, anodised aluminium poles for increased rigidity
- Ideally suited to eyeletted PVC or mesh substrates
- Graphics for outdoor use are recommended
- Optional carry bag available

I Graphics suitable for outdoor use are recommended.

For more product information visit www.thedisplaydirectory.com

GRAPHIC PANEL SIZES

- **Finished size:**
1000 x 2000/3000mm
- **Visual area:**
1000 x 2000/3000mm

pop-up systems

QUICK REFERENCE GUIDE



PRODUCT SELECTOR

PRICE INDICATOR

FRAME OPTIONS

KIT COMPONENTS

element



3x3 and 3x4 curved

Frame, mag bars, hanging kits, rigidising strips and moulded wheeled rigid case

PAGE 27

advantage curved



3x2, 3x3 and 3x4 curved

Frame, mag bars, hanging kits, rigidising strips, moulded wheeled rigid case, 2x flood lights, euro light adaptors, folding beech top, black fabric wrap and 30m roll of magnetic tape

PAGE 29

advantage straight



3x2, 3x3 and 3x4 straight

Frame, mag bars, hanging kits, rigidising strips, 2x stabilising feet, moulded wheeled rigid case, 2x flood lights, euro light adaptors, folding beech top, black fabric wrap and 30m roll of magnetic tape

PAGE 31

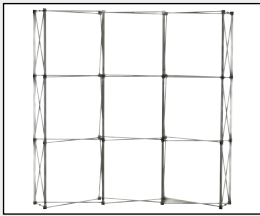

Magnetic pop-up frame.



Precision magnetic graphic attachment.



Yellow nodes signify top front of frame.

GRAPHIC PANEL SIZES

- **Inside curve:**
2130 x 653mm
- **'D' end:**
2130 x 653mm

element



SCAN ME FOR WEBPAGE



THE ESSENTIAL ELEMENT BUNDLE

BUNDLE INCLUDES:

- Element frame
- Magnetic bars
- Hanging kits
- Durable wheeled case

CODE	DESCRIPTION
91702	Element curved 3x3 pop-up bundle
91703	Element curved 3x4 pop-up bundle
OPTIONAL EXTRAS	
90872	Element/Advantage beech folding top
91714	Element/Advantage beech folding top and black wrap
90715	Element/Advantage black flood lights [each]
390025/S	30m roll of mag tape



features

- Bundle available in 3x3 and 3x4 curved configurations
- System can only be dressed on the front and 'D' ends

For our lighting range see pages 47-48.

For more product information visit www.thedisplaydirectory.com

element dimensions

3x3 curved frame

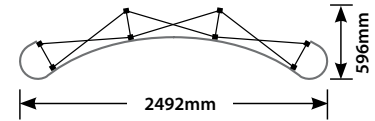

3x4 curved frame

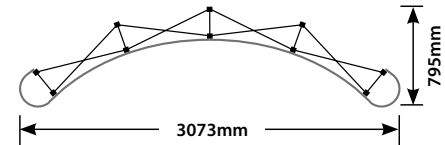

assembled height

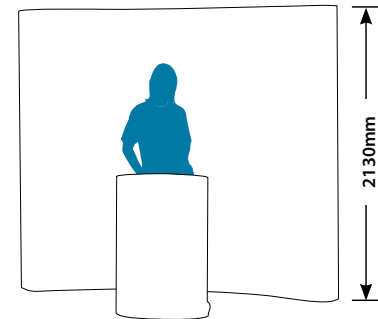

- Visible graphic height 2130mm
- Optional extras available – beech top, fabric wrap, lights, roll of mag tape



Fully magnetic pop-up frame including many extras.



Precision magnetic graphic attachment.



'Case to lectern' conversion kit and beech lectern top included as standard.

GRAPHIC PANEL SIZES

- **Inside curve:**
2130 x 653mm
- **Outside curve:**
2130 x 757mm
- **'D' end:**
2130 x 653mm

advantage curved

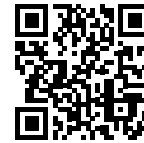

SCAN ME FOR WEBPAGE



THE COMPLETE ADVANTAGE BUNDLE

BUNDLE INCLUDES:

- Advantage frame
- Magnetic bars
- Hanging kits
- 2x 150W flood lights
- Durable wheeled case
- Beech folding top
- Fabric wrap for case
- Roll of magnetic tape

Just add graphics!

CODE	DESCRIPTION
91702	Advantage curved 3x2 pop-up bundle
30266	Advantage curved 3x3 pop-up bundle
30316	Advantage curved 3x4 pop-up bundle



features

- Bundle available in 3x2, 3x3 and 3x4 curved configurations
- Visible graphic height 2130mm
- Hanging kits and additional mag bars available to dress rear of system [see page 91]

For our lighting range see pages 47-48.

For more product information visit www.thedisplaydirectory.com

advantage dimensions

3x2 curved frame

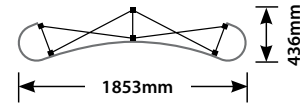

3x3 curved frame

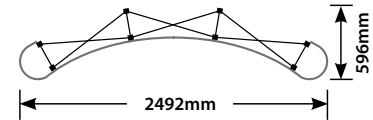

3x4 curved frame

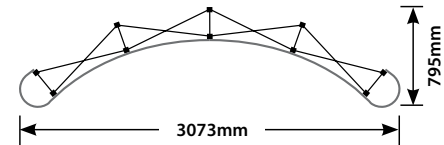

assembled height

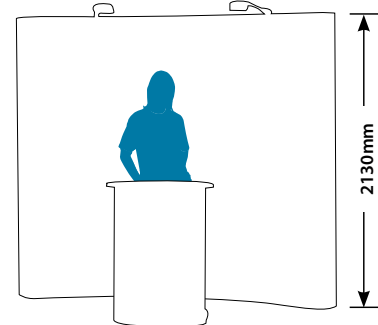

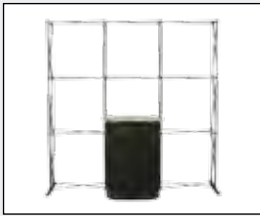

Fully magnetic pop-up frame including case, wrap and lectern top.



Precision magnetic graphic attachment.



'Case to lectern' conversion kit and beech lectern top included as standard.

GRAPHIC PANEL SIZES

- **Inside straight:**
2130 x 700mm
- **Outside straight:**
2130 x 700mm
- **'D' end:**
2130 x 653mm

advantage straight



SCAN ME FOR WEBPAGE



THE COMPLETE ADVANTAGE BUNDLE

BUNDLE INCLUDES:

- Advantage frame
- Magnetic bars
- Hanging kits
- 2x Stabilising feet
- 2x 150W flood lights
- Durable wheeled case
- Beech folding top
- Fabric wrap for case
- Roll of magnetic tape

Just add graphics!

CODE	DESCRIPTION
91782	Advantage straight 3x2 pop-up bundle
91783	Advantage straight 3x3 pop-up bundle
91784	Advantage straight 3x4 pop-up bundle



features

- Bundle available in 3x2, 3x3 and 3x4 straight configurations
- Visible graphic height 2130mm
- Hanging kits and additional mag bars available to dress rear of system [see page 91]

For our lighting range see pages 47-48.

For more product information visit www.thedisplaydirectory.com

advantage dimensions

3x2 straight frame

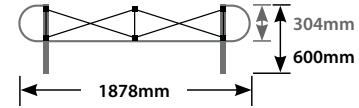

3x3 straight frame

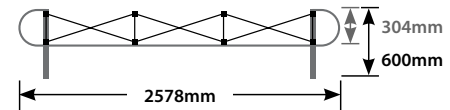

3x4 straight frame

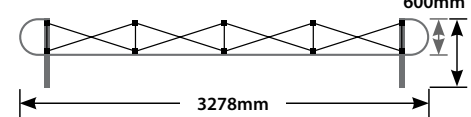

assembled height

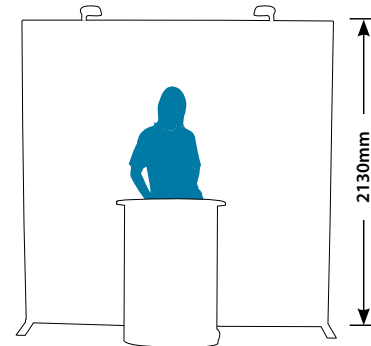

modular displays

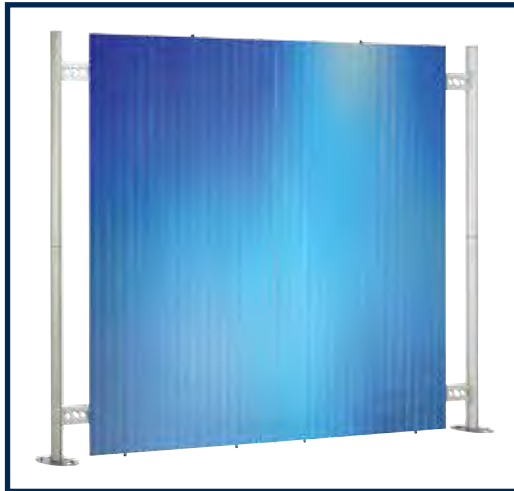
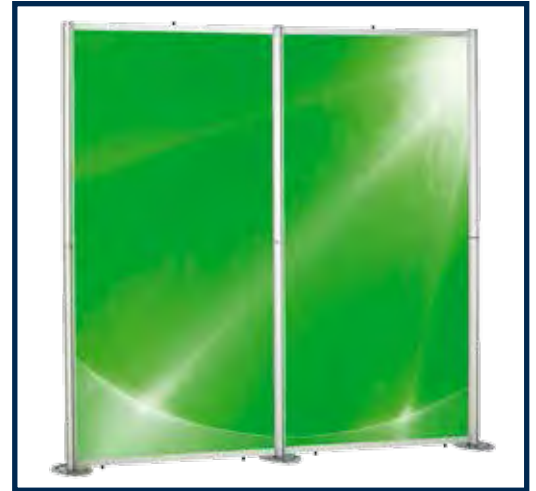

fusion rapid

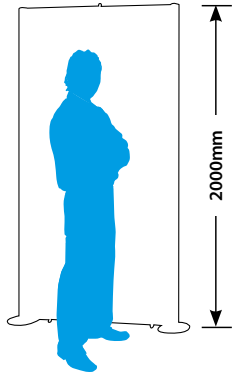

SCAN ME FOR WEBPAGE



Post sections fit together effortlessly with our unique magnetic twist and lock.



Rigid graphic materials slide easily into the 8mm recessed frame.

CODE	DESCRIPTION
30295	Fusion rapid 1 straight frame system
30296	Fusion rapid 2 straight frame system
30297	Fusion rapid 3 straight frame system
40411	Carry case kit A – for use with Fusion rapid 1
40413	Carry case kit C – for use with Fusion rapid 2
40414	Carry case kit D – for use with Fusion rapid 3

features

- Post sections fit together effortlessly with our unique magnetic twist and lock
- Suitable for use with rigid panels (up to 8mm thick)
- Can be used single or double-sided
- Straight systems only, available as 1, 2 and 3 panel kits
- 2000mm high posts can be disassembled into 1000mm sections
- Each graphic panel is 1944 x 950mm
- Rapid system is compatible with the Versa system

For our lighting range see pages 47-48. For footprint information see page 37.

For more product information visit www.thedisplaydirectory.com

GRAPHIC PANEL SIZES

- **Panel size:**
1944 x 950mm
- **Substrate thickness:**
8mm – max.



Flexible graphics magnetically attach to the aluminium framework.



Carry case kit – includes bag set and Comet wheeled case.

GRAPHIC PANEL SIZES

- **Straight rigid panel:**
1941 x 945mm
- **Straight magnetic panel:**
2000 x 1000mm
- **Curved magnetic panel:**
2000 x 1000mm

fusion versa

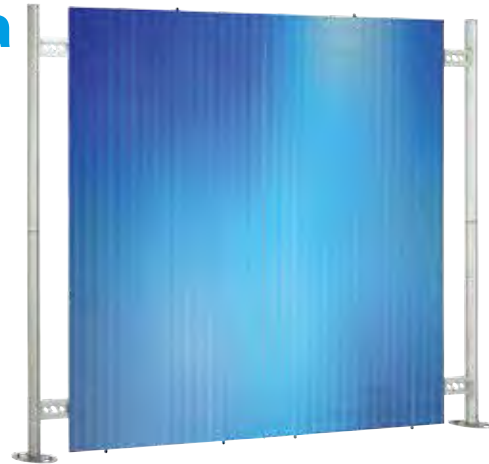
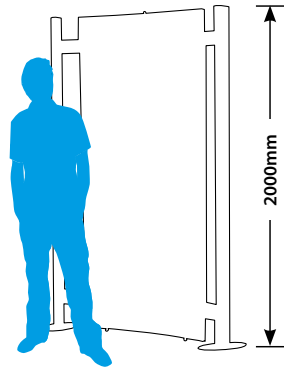

SCAN ME FOR WEBPAGE

CODE	DESCRIPTION
30300	Fusion versa 1 straight frame system
30301	Fusion versa 2 straight frame system
30302	Fusion versa 3 straight frame system
30310	Fusion versa 1 curved frame system
30311	Fusion versa 2 curved frame system
30312	Fusion versa 3 curved frame system
40411	Carry case kit A – for use with Fusion versa 1 and 2 frame systems
40412	Carry case kit B – for use with Fusion versa 3 frame system
390025/S	30m roll of mag tape

features

- Post sections fit together effortlessly with our unique magnetic twist and lock
- Flexible graphics, suitable for use with straight or curved systems
- Rigid graphics only suitable for use with straight systems
- Can be used single or double-sided
- Straight or curved systems, available as 1, 2 and 3 panel kits
- Fusion Versa comes complete with fixing kits [single-sided only]
- Versa system can be used with the Rapid system
- Posts, frames and other spare parts available [see page 91].

For our lighting range see pages 47-48. For footprint information see page 37. PLEASE NOTE: Mag tape is not included with fusion kits.

For more product information visit www.thedisplaydirectory.com

fusion accessories

table kit

features

- 1m high post and base
- Silver laminated tabletop and associated fixings
- Suitable for use with Versa and Rapid systems



CODE	DESCRIPTION
90837	Table kit

LCD bracket

features

- Fixed bracket
- Holds maximum weight of 15kg or 30" LCD display
- VESA mounting compliant [75, 100mm]
- Suitable for Versa and Rapid systems



CODE	DESCRIPTION
40362	LCD bracket

literature unit

features

- A4 portrait configuration
- Easy post attachment
- Suitable for Versa and Rapid systems
- Left or right side fitting option



CODE	DESCRIPTION
80276	A4 literature unit / left side fixing
80275	A4 literature unit / right side fixing

carry equipment

features

- Rotationally moulded lockable transportation cases
- Wheels for easy transportation
- Holds fusion kit bags
- Bags supplied as part of kit



For more information see page 49

CODE	DESCRIPTION
40411	Fusion carry case kit A
40412	Fusion carry case kit B
40413	Fusion carry case kit C
40414	Fusion carry case kit D

fusion footprints

fusion rapid

1 panel straight



2 panel straight

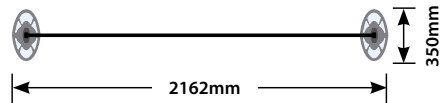

3 panel straight



fusion table kit

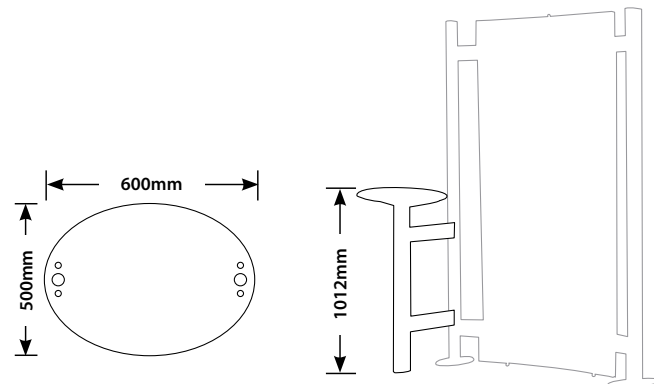

fusion versa

curved configurations

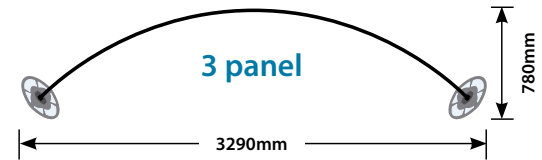
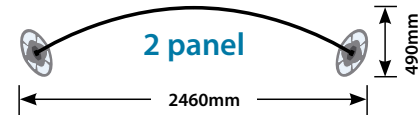

straight configurations

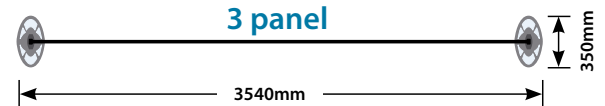
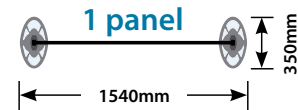

panel and pole kits



PK53 – 4 panel and pole kit.



PK58 – 6 panel and pole kit.



SCAN ME FOR WEBPAGE

custom kits

CODE	DESCRIPTION
PK53	4 panel and pole kit
PK58	6 panel and pole kit
100130	900 x 600 panel
100060	200 x 900 panel
100030	200 x 600 panel
259001	900mm [25mm diameter] pole
252002	200mm [25mm diameter] pole
891111	Bar foot [inc. fittings]

features

- Double-sided, reversible panel and pole kits
- Individual panel size 900 x 600mm
- Hard-wearing black or grey PVC frame, supplied with rubberised pole clips
- Lightweight panels are easy to reconfigure
- System constructed using 25mm alloy poles and bar feet. Black or grey to complement framework
- The loop nylon covering is fire retardant to BS 5867

For our lighting range see pages 47-48. Choose frame colour and fabric colour at time of ordering.

For more product information visit www.thedisplaydirectory.com

CUSTOM FABRIC COLOURS

Any combination of the following:



Sungold



Special blue



Royal blue



Regal blue



Emerald green



Bottle green



Silver grey



Dove grey



Cherry red



Burgundy



Black

FABRIC PANEL SIZES

- **PK53 kit panel sizes:**
[4x] 600 x 900mm
- **PK58 kit panel sizes:**
[6x] 900 x 600mm



16mm hard wearing PVC frame.



360° hinge.

folding panel kits

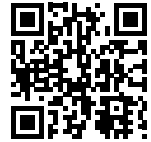

SCAN ME FOR WEBPAGE



PK51 – Mini table top kit.



PK52 – Maxi table top kit.

FABRIC PANEL SIZES

- **Mini table top kit panel sizes:**
600 x 900mm,
[2x] 600 x 450mm and
200 x 900mm
- **Maxi table top kit panel sizes:**
[3x] 900 x 600mm and
200 x 600mm
- **PK511 kit panel sizes:**
[6x] 900 x 600mm and
200 x 600mm

stocked kits

CODE	DESCRIPTION
PK51/3	Mini table top kit and carry bag
PK52/3	Maxi table top kit and carry bag
PK511/3	6 panel folding kit inc. header panel and carry bag

custom kits

CODE	DESCRIPTION
PK51	Mini table top kit and carry bag
PK52	Maxi table top kit and carry bag
PK511	6 panel folding kit inc. header panel and carry bag



PK511 – 6 panel folding kit.

stocked kits – features

- Frame colour option – grey [N.B. Black fabric kit supplied with black frame as standard]
- Double-sided, reversible, free standing, hinged lightweight kits

custom kits – features

- Tailor your kit by choosing from our range of fabric colours and frame options

- Individual panel size 900 x 600mm surrounded by a 16mm hard wearing PVC frame
- The loop nylon covering is fire retardant to BS 5867

- Frame colour options – grey or black
- The loop nylon covering is fire retardant to BS 5867

For our lighting range see pages 47-48. Choose frame colour and fabric colour at time of ordering.

For more product information visit www.thedisplaydirectory.com

STOCKED FABRIC COLOURS:



Cherry red



Emerald green



Royal blue



Dove grey

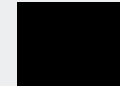

Black



Grey / Blue

CUSTOM FABRIC COLOURS

Any combination of the following:



Sungold



Special blue



Royal blue



Regal blue



Emerald green



Bottle green



Silver grey



Dove grey



Cherry red



Burgundy



Black

literaturestands

QUICK REFERENCE GUIDE



PRODUCT SELECTOR

PRICE INDICATOR

CAPACITY

HEIGHT

FOOTPRINT

media compact portrait



6 x A4 portrait shelves

1475mm

280 [w] x 290 [d]mm

PAGE 42

media 4 deluxe



4 x A4 portrait pockets

1520mm

260 [w] x 280 [d]mm

PAGE 43

media compact portrait

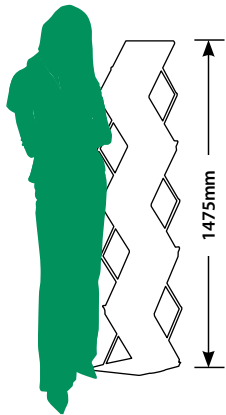

Footprint: 280 [w] x 290 [d]mm



SCAN ME FOR WEBPAGE



Aluminium case.



Hinged locking mechanism.

CODE	DESCRIPTION
90482	Media compact portrait

features

- Collapsible A4 portrait literature holder
- Single or double-sided
- 6 x A4 portrait shelves
- Steel and aluminium frame
- Transparent acrylic shelving
- Supplied with an aluminium case

For more product information visit www.thedisplaydirectory.com



Reinforced carry bag.



Locking mechanism.

media 4 deluxe



SCAN ME FOR WEBPAGE

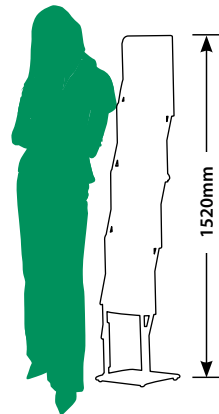

Footprint: 260 [w] x 280 [d]mm



CODE	DESCRIPTION
90996	Media 4 deluxe

features

- Collapsible portrait literature holder
- Single-sided
- 4 x A4 portrait literature pockets
- Chrome base
- Virtually unbreakable Polycarbonate pockets
- Supplied with a reinforced carry bag

For more product information visit www.thedisplaydirectory.com

in-store promotion units



in-store promotion unit

PRODUCT SELECTOR

PRICE INDICATOR
STORAGE
HEIGHT
FOOTPRINT

£
2 x Internal storage shelves
OVERALL HEIGHT 2200mm - WORKTOP HEIGHT 905mm
790 [w] x 480 [d]mm

PAGE 45



wheeled in-store promotion unit

£ £
1 x Internal storage shelf
OVERALL HEIGHT 2190mm - WORKTOP HEIGHT 910mm
795 [w] x 480 [d]mm

PAGE 46



Easily folded down.



Two handy internal storage shelves.

in-store promotion unit

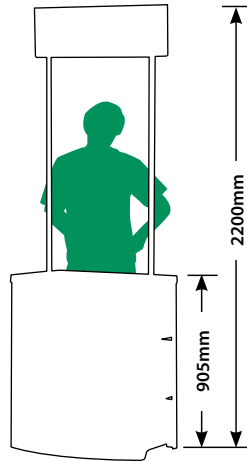

Footprint: 790 [w] x 480 [d]mm



SCAN ME FOR WEBPAGE

GRAPHIC PANEL SIZES

Header panel

- **Visual area:**
345 x 795mm

Base unit

- **Overall size:**
900 x 2000mm
- **Visual area of front:**
826 [w] x 815 [h]mm
[35mm is hidden
by the top of the unit]

CODE	DESCRIPTION
705126	In-store promotion unit
30332	In-store promotion unit with header and double pole set

features

- Two internal shelves for maximum storage
- Pole set and header optional extra
- Folds flat for easy transportation
- Robust but lightweight
- Easy to add graphics for instant branding
- Wipe clean PVC surface
- Supplied with carry bag
- Overall assembled height 2200mm

For more product information visit www.thedisplaydirectory.com

wheeled in-store promotion unit

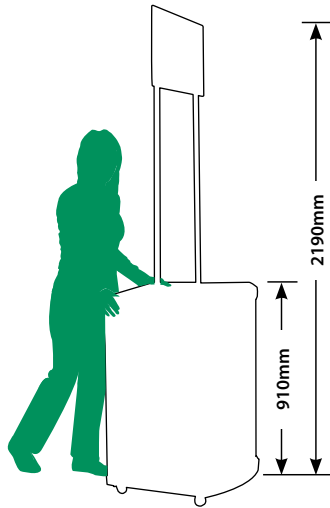

Footprint: 795 [w] x 480 [d]mm



SCAN ME FOR WEBPAGE



Castors for easy manoeuvrability.



Wipe clean PVC surface.

CODE	DESCRIPTION
91749	Wheeled in-store promotion unit
91750	Wheeled in-store promotion unit with header and double pole set

features

- One internal shelf
- Solid base with lockable castors
- Pole set and header optional extra
- Folds flat for easy transportation
- Easy to add graphics for instant branding
- Robust but lightweight and moveable
- Supplied with carry bag
- Overall assembled height 2190mm

For more product information visit www.thedisplaydirectory.com

GRAPHIC PANEL SIZES

Header panel

- **Visual area:**
345 x 795mm

Base unit

- **Overall size:**
855 x 2000mm
- **Visual area of front:**
826 [w] x 785 [h]mm
[35mm is hidden by the top and bottom of the unit]



Curved arm universal roller banner clamp.



SCAN ME FOR WEBPAGE

LIGHTING SIZES

Sirius Straight Arm

• Length: 400mm

Sirius Curved Arm

• Length: 450mm

Polaris Arm with Light Fitting

• Length: 400mm

Polaris Arm with Bulldog Clip

• Length: 275mm

Vega Arm

• Length: 260mm

lighting

sirius: 50 watt mains spotlight



Chrome finish.



Also available in a satin chrome finish.



Straight arm light fitting.



Curved arm universal banner clamp.

polaris: 50 watt mains spotlight



Black finish.



Also available in a silver finish.



Straight arm light fitting.



Bulldog clip.

vega: 150 watt mains floodlight



Black finish.



Also available in a silver finish.



Pop-up cross arm fitting.

sirius

CODE	DESCRIPTION
91317	Sirius / satin chrome
91317/9	Sirius / chrome
91829	Sirius curved arm / satin chrome
91829/9	Sirius curved arm / chrome

- 50W mains spotlight
- Chrome or satin chrome finishes
- Supplied complete with light fitting or universal banner clamp
- GU10 bulb - 50W

polaris

CODE	DESCRIPTION
91316/1	Polaris / black
91316/9	Polaris / silver
91316/1B	Polaris / black bulldog
91316/9B	Polaris / silver bulldog

- 50W mains spotlight
- Silver and black finishes
- Supplied complete with bulldog clip or light fitting
- GU10 bulb - 50W

vega

CODE	DESCRIPTION
90715	Vega / black
90715/9	Vega / silver

- 150W Halogen flood light
- Silver and black finishes
- Supplied complete with pop-up frame fitting
- Halogen linear R7 bulb - 78mm - 150w

lighting options

	SIRIUS 50 W spotlight STRAIGHT ARM with light fitting	SIRIUS 50 W spotlight CURVED ARM with universal banner clamp	POLARIS 50 W spotlight STRAIGHT ARM with light fitting	POLARIS 50 W spotlight STRAIGHT ARM with Bulldog clip	VEGA 150 W floodlight STRAIGHT ARM with pop-up cross arm fitting
ROLLER BANNERS					
Atom		●			
Zeta	●	●	●		
Neo		●			
Genie	●	●	●		
Sigma	●	●	●		
Organic		●			
Sidewinder	●	●	●		
Omega	●	●	●		
STATIC BANNERS					
Cobra	●	●	●		
Illusion	●		●		
POP-UPS					
Element					●
Advantage Curved					●
Advantage Straight					●
MODULAR DISPLAYS					
Fusion Rapid	●		●		
Fusion Versa	●		●		
Panel and Pole Kits				●	
Folding Kits				●	

PLEASE NOTE: All lights have **CE marking** and are **ROHS compliant**. For more product information visit www.thedisplaydirectory.com



Comet 85 case [with 3x2 pop-up system including fixings and graphics].



Comet 115 case [with Fusion kit bags].



Meteor case packed with a pop-up kit and graphics.



Meteor case lighting compartment in the lid.

pop-up/fusion cases

comet case

features

- Rotationally moulded lockable transportation cases
- Wheels for easy transportation
- Available in 850mm and 1150mm internal heights
- Holds pop-up frame with fixtures and graphics [3x2 frame only]
- Holds fusion kit bags and graphics

CODE	DESCRIPTION
91457	Comet 85 case [850mm high]
91458	Comet 115 case [1150mm high]
40411	Fusion carry case kit A
40412	Fusion carry case kit B
40413	Fusion carry case kit C
40414	Fusion carry case kit D



meteor case

features

- Rotationally moulded wheeled, lockable transportation case
- Suitable for transporting up to a 3x4 pop-up frame and graphics
- Complete with lighting compartment in the lid, which suits all lights

CODE	DESCRIPTION
90583	Meteor case



panel and accessory bags

features

- Standard carry bags are supplied with webbing handles and shoulder straps
- Economy carry bags are supplied with grab handles
- Lightweight and foldable



CODE	DESCRIPTION
707010	900 x 600mm panel standard carry bag [160mm bag depth]
707051	900 x 600mm panel economy carry bag [100mm bag depth]

graphic carry tube

features

- Rigid carry tube with carry strap
- Internal dimensions:
1030 x 120mm diameter



CODE	DESCRIPTION
30242	Carry tube / black

For more product information visit www.thedisplaydirectory.com



Case holds 2x 800mm Genie bannerstands.



Case holds 1x 800mm Sidewinder bannerstand and 1x 50W spotlight.



Suitable for all lights from our lighting range.

bannerstand transit case

features

- Textured aluminium finish and stylish chrome reinforced rounded corners
- 800mm case holds 2x 800mm Genies or 3x Zetas or 1x 800mm Sidewinder and 50W spotlight



CODE	DESCRIPTION
91023	Genie/Zeta 800mm bannerstand case
91343	Sidewinder 800mm bannerstand case

lighting case

features

- Durable aluminium lighting case
- Internal size: 560 [l] x 330 [w] x 150 [d] mm



CODE	DESCRIPTION
90367	Lighting case

For more product information visit www.thedisplaydirectory.com

PAVEMENT AND FORECOURT SIGNAGE

INDOOR SIGNAGE



signage

pavementsignage

QUICK REFERENCE GUIDE



For more information visit
www.thedisplaydirectory.com

PRODUCT SELECTOR

PRICE INDICATOR
WEIGHT
HEIGHT
FOOTPRINT



sign wedge

£
6.1kg
795mm
420 [w] x 420 [d]mm

PAGE 55



folding
swing sign

£
5.9kg
846mm
585 [w] x 585 [d]mm

PAGE 56



classic
swing sign

£	£
10.5kg	
915mm	
585 [w] x 460 [d]mm	

PAGE 57



switch
swing sign

£	£
10.5kg	
915mm	
585 [w] x 460 [d]mm	

PAGE 58



aquabase



11.0kg
41.0kg with water

1130mm

740 [w] x 610 [d]mm

PAGE 59

aquabase swap



11.0kg
41.0kg with water

1215mm

740 [w] x 610 [d]mm

PAGE 60

A-frame



A0 = 17kg / A1 = 10.5kg / A2 = 6.8kg

A0 = 1445mm / A1 = 1165mm /
A2 = 985mm

A0 = 883 [w] x 805 [d] / A1 = 625 [w] x 670 [d] /
A2 = 465 [w] x 680 [d]mm

PAGE 61

traditional chalk board



Small = 10.0kg
Large = 11.5kg

Small = 990mm
Large = 1200mm

Small = 590 [w] x 650 [d]mm
Large = 715 [w] x 750 [d]mm

PAGE 62

rounded chalk board



Small = 10.0kg
Large = 13.0kg

Small = 900mm
Large = 1100mm

Small = 590 [w] x 640 [d]mm
Large = 720 [w] x 700 [d]mm

PAGE 63



Aluminium graphic panel friction fits into base.



Heavy duty circular recycled PVC base with hand holes for easy transportation.

sign wedge

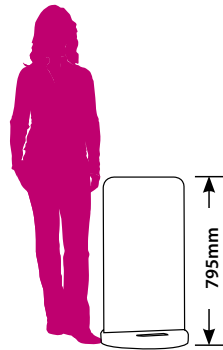

Footprint: 420 [w] x 420 [d]mm



SCAN ME FOR WEBPAGE



CODE	DESCRIPTION
40398	Sign wedge
80263	Replacement sign blank

GRAPHIC PANEL SIZES

- **Blank size:**
780 x 410mm
[top corners have a radius of 50mm]
- **Visual area:**
740 x 410mm
[top corners have a radius of 50mm]

features

- Double-sided graphic area
- White printable aluminium sign blank
- Printable graphic area 740 x 410mm
- Recycled PVC base
- Quick and easy assembly, no tools required
- Hand holes in base
- Graphic friction fits into base

 Graphics suitable for outdoor use are recommended.

For more product information visit www.thedisplaydirectory.com

folding swing sign

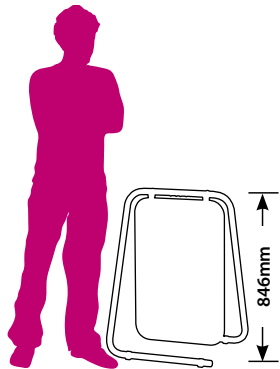

Footprint: 585 [w] x 585 [d]mm



SCAN ME FOR WEBPAGE

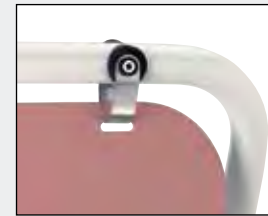

Stainless steel tamper proof hanging clips.



Spring button allows frame to fold flat.



Robust black plastic feet.

CODE	DESCRIPTION
91753	Folding swing sign
80267	Replacement sign blank

features

- No assembly required
- Folds flat for storage
- Easy to handle when folded flat
- White printable aluminium sign blank
- Printable graphic area 750 x 500mm
- Simple, yet sturdy design

 Graphics suitable for outdoor use are recommended.

For more product information visit www.thedisplaydirectory.com

GRAPHIC PANEL SIZES

- **Blank size:**
750 x 500mm [corners have a radius of 75mm]
- **Visual area:**
750 x 500mm [corners have a radius of 75mm]



Frames available in white, black or grey.



Stainless steel tamper proof hanging clips.



Robust frame secures into heavy duty recycled PVC Base.

GRAPHIC PANEL SIZES

- **Blank size:**
750 x 500mm [corners have a radius of 75mm]
- **Visual area:**
750 x 500mm [corners have a radius of 75mm]

classic

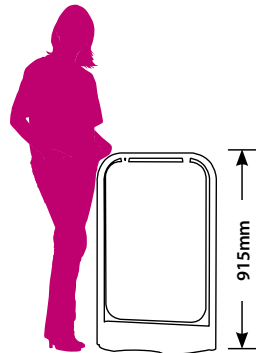

Footprint: 585 [w] x 460 [d]mm



SCAN ME FOR WEBPAGE



CODE	DESCRIPTION
40404	Classic swing sign / white frame
40405	Classic swing sign / black frame
91817	Classic swing sign / grey frame
80267	Replacement sign blank

features

- Double-sided graphic area
- White printable aluminium sign blank
- Printable graphic area 750 x 500mm
- Frame available in white, black or grey
- Recycled PVC base
- Quick and easy assembly, no tools required

 Graphics suitable for outdoor use are recommended.

For more product information visit www.thedisplaydirectory.com

switch

ADDITIONAL
COLOUR
OPTIONS

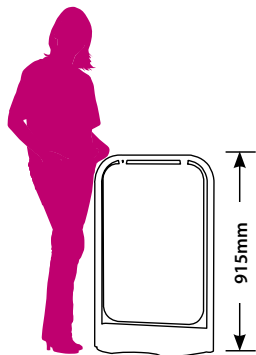

Footprint: 585 [w] x 460 [d]mm



SCAN ME FOR WEBPAGE



Magnetic poster pocket holds A2 graphic/posters.



Frames available in white, black or grey.



Stainless steel tamper proof hanging clips.

CODE	DESCRIPTION
40402	Switch swing sign / white frame / white poster pocket
40403	Switch swing sign / black frame / black poster pocket
91818	Switch swing sign / grey frame / grey poster pocket

features

- Double-sided magnetic A2 poster pocket with printable header section
- Frame and poster pocket available in white, black or grey
- Houses A2 poster (594 x 420mm)
- Recycled PVC base
- Quick and easy assembly, no tools required

I Graphics suitable for outdoor use are recommended.

For more product information visit www.thedisplaydirectory.com

GRAPHIC PANEL SIZES

- **Poster size:**
A2 – 594 x 420mm
- **Visual area:**
575 x 400mm



Stainless steel tamper proof hanging clips.



Wheeled base for easy manoeuvrability.

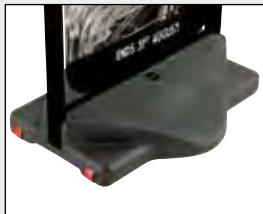

Water or sand can be used to fill base.

GRAPHIC PANEL SIZES

- **Blank size:**
910 x 640mm [corners have a radius of 75mm]
- **Visual area:**
910 x 640mm [corners have a radius of 75mm]

aquabase

ADDITIONAL
COLOUR
OPTIONS

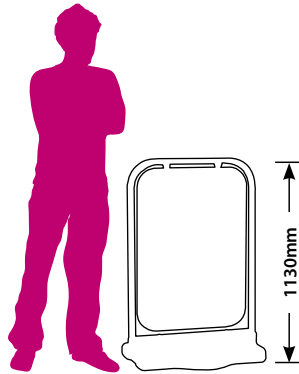

Footprint: 740 [w] x 610 [d]mm



SCAN ME FOR WEBPAGE



CODE	DESCRIPTION
91819	Aquabase / white frame
91820	Aquabase / black frame
91821	Aquabase / grey frame
91762	Replacement sign blank

features

- Double-sided graphic area
- White printable aluminium sign blank
- Printable graphic area 910 x 640mm
- Quick and easy assembly
- Frame available in white, black or grey
- Robust frame and water fillable base give great stability even in adverse weather conditions
- Wheels in base allow unit to be manoeuvred into position
- Base capacity 30 litres

 Graphics suitable for outdoor use are recommended.

For more product information visit www.thedisplaydirectory.com

aquabase swap

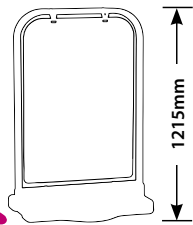

Footprint: 740 [w] x 610 [d]mm



SCAN ME FOR WEBPAGE



Magnetic poster pocket holds A1 graphic or poster.



Stainless steel tamper proof hanging clips.



Wheeled base for easy manoeuvrability.

CODE	DESCRIPTION
91814	Aquabase Swap swing sign / white frame
91815	Aquabase Swap swing sign / black frame
91816	Aquabase Swap swing sign / grey frame

features

- Double-sided magnetic A1 poster pocket (841 x 594mm) with printable header section
- Frame and poster pocket available in three colours:- white, black and grey
- Quick and easy assembly
- Robust frame and water fillable base give great stability even in adverse weather conditions
- Wheels in base allow unit to be manoeuvred into position
- Base capacity 30 litres

 Graphics suitable for outdoor use are recommended.

For more product information visit www.thedisplaydirectory.com

GRAPHIC PANEL SIZES

- **Poster size:**
A1 - 841 x 594mm
- **Visual area:**
831 x 584mm



Rounded chrome corners.



Secure locking arms.

A-frame

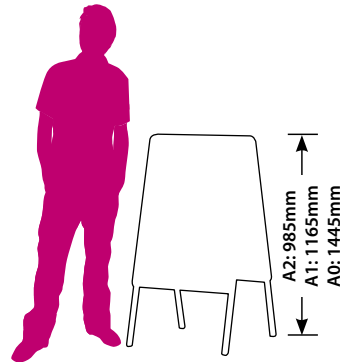

A2 footprint: 465 [w] x 680 [d]mm

A1 footprint: 625 [w] x 670 [d]mm

A0 footprint: 883 [w] x 805 [d]mm

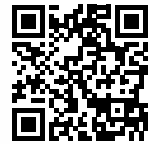

SCAN ME FOR WEBPAGE



GRAPHIC PANEL SIZES

• Finished size:

A2 – 594 x 420mm

A1 – 841 x 594mm

A0 – 1189 x 841mm

• Visual area:

A2 – 574 x 400mm

A1 – 821 x 574mm

A0 – 1169 x 821mm

features

- Double-sided
- Easy change snapframe mechanism securely holds posters in place
- Galvanised steel backing adds weight and strength
- Houses posters in A0 (1189 x 841mm), A1 (841 x 594mm) and A2 (594 x 420mm)
- 32mm wide aluminium snapframe

! Graphics suitable for outdoor use are recommended.

For more product information visit www.thedisplaydirectory.com

CODE	DESCRIPTION
90621	A2 A-frame / double-sided
90620	A1 A-frame / double-sided
90619	A0 A-frame / double-sided

traditional chalk board



SCAN ME FOR WEBPAGE

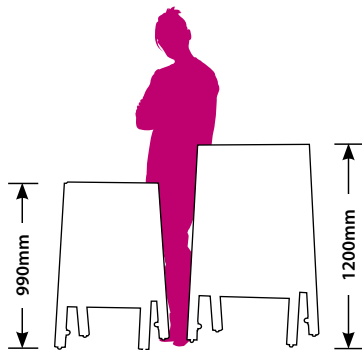

Small chalk board footprint: 590 [w] x 650 [d]mm

Large chalk board footprint: 715 [w] x 750 [d]mm



Secure locking arms.



Fixing point for chain [chain not supplied].



Use chalk board pens or traditional chalk for best results.

CODE	DESCRIPTION
91379	Small traditional chalk board
91378	Large traditional chalk board
91470	Chalk board pen set – 8 pack
91473	Chalk board cleaner pen

features

- Double-sided traditional wood framed chalk board
- Chalk board area – 650 x 470mm (small), 843 x 596mm (large)
- Chalk board surface is UV stable, weather and scratch resistant
- Rubber feet
- Steel fixing point for chain (chain not included)
- Strong steel locking arms

For more product information visit www.thedisplaydirectory.com

GRAPHIC PANEL SIZES

- Chalk board area:
Small – 650 x 470mm
Large – 843 x 596mm

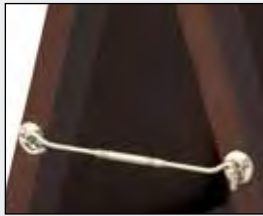

Ornate locking arm.



Removable laminate panels.



Fixing point for chain [chain not supplied].

rounded chalk board

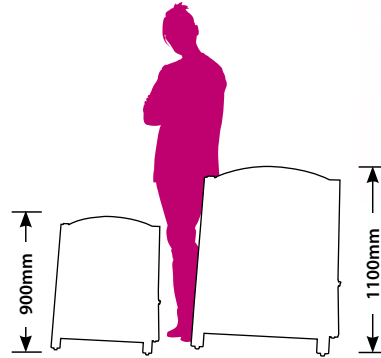

Small chalk board footprint: 590 [w] x 640 [d]mm

Large chalk board footprint: 720 [w] x 700 [d]mm



SCAN ME FOR WEBPAGE



CODE	DESCRIPTION
91571	Small rounded chalk board
91572	Large rounded chalk board
91470	Chalk board pen set – 8 pack
91473	Chalk board cleaner pen

features

- Double-sided traditional wood framed round top chalk board
- Removable (and reversible) chalk board panels
- Chalk board area – 720 x 470mm (small), 920 x 600mm (large)
- Rubber feet
- Steel fixing point for chain (chain not included)
- Ornate steel locking arms

GRAPHIC PANEL SIZES

- Chalk board area:
Small – 720 x 470mm
Large – 920 x 600mm

For more product information visit www.thedisplaydirectory.com

H. Hollinworths



HALF PRICE
COOKED CHICKENS

forecourtsignage

forecourtsignage

QUICK REFERENCE GUIDE



For more information visit
www.thedisplaydirectory.com



icon

PRODUCT SELECTOR

PRICE INDICATOR
GRAPHIC SIZE
DIMENSIONS
BASE CAPACITY

£ £ £ £
A1 = [841 x 594mm]
A1 = 1215 [h] x 740 [w] x 610 [d]mm
A1 = 30 litres

PAGE 66



H2O swingmaster

£ £
A0 = [1189 x 841mm] A1 = [841 x 594mm]
A0 = 1530 [h] x 1030 [w] x 650 [d]mm A1 = 1150 [h] x 780 [w] x 500 [d]mm
A0 = 50 litres / A1 = 26 litres

PAGE 67

icon

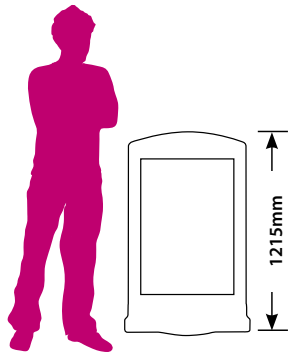

Footprint: 740 [w] x 610 [d]mm



SCAN ME FOR WEBPAGE



Hinged magnetic poster pocket enables graphics to be changed easily without the need for tools.



Wheeled base can be filled with sand or water for extra stability.



Recessed header for individual or corporate branding.

CODE	DESCRIPTION
30333	A1 icon

features

- A1 double-sided heavy duty forecourt sign
- Strong steel frame and galvanised steel backing
- Unique hinged magnetic poster pocket, allows posters to be quickly and easily changed by one person
- Wheels in base allow unit to be manoeuvred into position
- Recessed area on header allows for extra branding
- Water fillable base; 30 litre capacity

I Graphics suitable for outdoor use are recommended.

For more product information visit www.thedisplaydirectory.com

GRAPHIC PANEL SIZES

- **Finished size:**
841 x 594mm
- **Visual area:**
814 x 577mm



Posters are secured by 32mm aluminium snapframe profile.



Wheeled base for easy manoeuvrability.



Weighted base can be filled with water or sand for extra stability.

GRAPHIC PANEL SIZES

• **Finished size:**

- A1 – 841 x 594mm
- A0 – 1189 x 841mm

• **Visual area:**

- A1 – 827 x 580mm
- A0 – 1175 x 827mm

H2O swingmaster

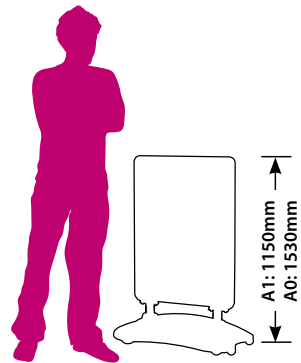

A1 footprint: 780 [w] x 500 [d]mm
A0 footprint: 1030 [w] x 650 [d]mm



SCAN ME FOR WEBPAGE



CODE	DESCRIPTION
91708	A1 H2O swingmaster
91709	A0 H2O swingmaster

features

- Double-sided outdoor forecourt sign, available in two sizes, A0 and A1
- Steel reinforced rounded corners
- Protective pads stop damage to underside of base
- Quick and easy assembly, no tools required
- Wheels in base allow unit to be manoeuvred into position
- Water fillable base gives great stability even in adverse weather conditions
- Base capacity; A1 – 26 litres and A0 – 50 litres

! Graphics suitable for outdoor use are recommended.

For more product information visit www.thedisplaydirectory.com

indoorsignage



gripframes

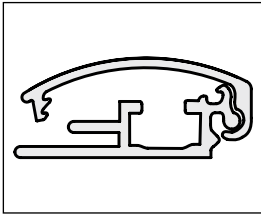

25mm profile with mitred corners.

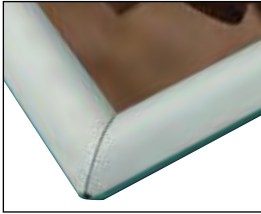

Satin anodised finish.



GRAPHIC PANEL SIZES

• Finished size:

A4 – 297 x 210mm

A3 – 420 x 297mm

A2 – 594 x 420mm

A1 – 841 x 594mm

A0 – 1189 x 841mm



SCAN ME FOR WEBPAGE



Frame snaps open with ease.



Remove protective acetate sheet.



Insert graphic or poster and snap shut.

CODE	DESCRIPTION
91720	A0 25mm profile gripframe
91721	A1 25mm profile gripframe
91722	A2 25mm profile gripframe
91723	A3 25mm profile gripframe
91724	A4 25mm profile gripframe

features

- Snap opening frames in a satin anodised finish
- Available in 5 sizes – A0, A1, A2, A3 and A4
- Single-sided wall mounted display
- Can be fitted landscape or portrait
- Comes complete with protective front covers
- Wall fixings and screws supplied as standard
- Individually boxed
- Visual area: 8mm around all edges is covered by the snapframe

N.B. For internal use only.

For more product information visit www.thedisplaydirectory.com



Information points can rotate from portrait to landscape.

PRODUCT HEIGHTS

- **A4 portrait/landscape:**
Portrait – 1210mm
Landscape – 1170mm
- **A3 portrait/landscape:**
Portrait – 1260mm
Landscape – 1200mm

FOOTPRINT SIZES

- **A4/A3**
325 [w] x 245 [l]mm

GRAPHIC PANEL SIZES

- **Finished size:**
A4 – 297 x 210mm
A3 – 420 x 297mm
- **Visual area:**
10,5mm around all edges is covered by the snapframe mechanism for all sizes

information points



SCAN ME FOR WEBPAGE



CODE	DESCRIPTION
90625	A4 portrait/landscape information point
90626	A3 portrait/landscape information point

features

- Snap opening frames in a satin anodised finish
- Frames rotate from portrait to landscape
- 25mm snap frame profile
- Stylish chrome rounded corners

N.B. For internal use only.

For more product information visit www.thedisplaydirectory.com

telescopic information points



SCAN ME FOR WEBPAGE

**NEW
SIZE
AVAILABLE**



CODE	DESCRIPTION
91781	A4 portrait/landscape telescopic information point
90624	A3 portrait/landscape telescopic information point

features

- Snap opening frames in a satin anodised finish
- 32mm snap frame profile
- Stylish chrome rounded corners
- A4 extends from 830mm to 1210mm (portrait)
- A3 extends from 890mm to 1250mm (portrait)
- Frames rotate from portrait to landscape
- Chrome base and telescopic pole
- Frame can be tilted to various angles

N.B. For internal use only.

For more product information visit www.thedisplaydirectory.com



32mm snapframe enables easy graphic change.



Telescopic information points can rotate from portrait to landscape.

PRODUCT HEIGHTS

- **A4 telescopic:**
Portrait - 830 to 1210mm
Landscape - 780 to 1160mm
- **A3 telescopic:**
Portrait - 890 to 1250mm
Landscape - 825 to 1185mm

FOOTPRINT SIZES

- **A4/A3**
320mm diameter

GRAPHIC PANEL SIZES

- **Finished size:**
A4 – 297 x 210mm
A3 – 420 x 297mm
- **Visual area:**
A4 – 277 x 190mm
A3 – 400 x 277mm



Height adjustable.



Holds iPad securely whilst in enclosure.



Lockable unit, with home button accessibility.

PRODUCT HEIGHTS

- **Portrait:**
Extends from 800 - 1220mm
- **Landscape:**
Extends from 760 - 1190mm

iPad holder

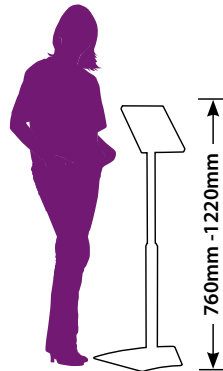

Footprint: 440 [w] x 345 [d]mm



SCAN ME FOR WEBPAGE



CODE	DESCRIPTION
91813	iPad holder - height adjustable

features

- Suitable for iPad 2, 3 or 4
- Can be used portrait or landscape
- Lockable
- Tilt facility for multiple viewing angle
- Height adjustable 700 - 1100mm
- Cable routing slot on rear of post
- Home button accessible
- Holes in base so unit can be secured to floor (fixings supplied)

N.B. For internal use only.

PLEASE NOTE: iPad not included.

For more product information visit www.thedisplaydirectory.com

lightboxes

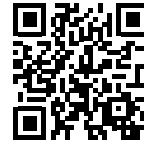

SCAN ME FOR WEBPAGE



48mm snapframe enables easy graphic change.



CODE	DESCRIPTION
91271	A1 EOS lightbox
91272	A2 EOS lightbox

features

- Edge lit style lightboxes with snap opening frames
- Single-sided wall mounted units
- Available to suit two poster sizes – A1 and A2
- 48mm snap frame profile
- CE marking and RoHS compliant
- Can be fitted portrait or landscape

N.B. For internal use only.

For more product information visit www.thedisplaydirectory.com

GRAPHIC PANEL SIZES

• Finished size:

A2 – 594 x 420mm

A1 – 841 x 594mm

• Visual area:

8mm around all edges is covered by the snapframe mechanism for all sizes



Slide graphic into 'Snapper'.

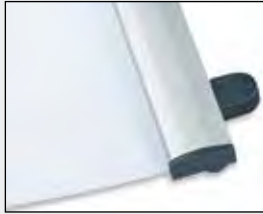

Snap action mechanism securely holds graphic in place.

poster snappers

4 SIZES AVAILABLE:

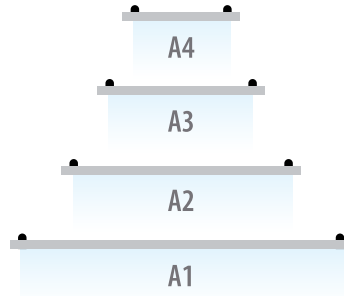

SCAN ME FOR WEBPAGE

CODE	DESCRIPTION
40157	594mm wide poster snapper [A2 landscape/A1 portrait]
40155	420mm wide poster snapper [A3 landscape/A2 portrait]
40153	297mm wide poster snapper [A4 landscape/A3 portrait]
40152	210mm wide poster snapper [A4 portrait]

GRAPHIC PANEL SIZES

• Finished size:

- A4 – 297 x 210mm
- A3 – 420 x 297mm
- A2 – 594 x 420mm
- A1 – 841 x 594mm

• Visual area:

14mm at the top and bottom is hidden by the poster snapper for all sizes

features

- Snap opening poster holder in a satin anodised finish
- Available in 4 sizes – A1, A2, A3, A4
- Plastic moulded end caps
- Holds material to a thickness of 500 microns

N.B. For internal use only.

For more product information visit www.thedisplaydirectory.com



cafébanners

QUICK REFERENCE GUIDE



PRODUCT SELECTOR

PRICE INDICATOR
GRAPHIC ATTACHMENT METHOD
WEIGHT OF POST
CROSS ARM WIDTH OPTIONS *

primo original



Top cross arm = mechanical slide-in hanger
Bottom cross arm = mechanical slide-in hanger

18kg

2000mm / 1500mm / 1200mm

PAGE 79

primo wrap



Top cross arm = looped graphic
Bottom cross arm = looped graphic

18kg

2000mm / 1500mm / 1200mm

PAGE 81

medio original



Top cross arm = mechanical slide-in hanger
Bottom cross arm = eyelet and spring clip

10.5kg

2000mm / 1500mm / 1200mm

PAGE 83

* Width is calculated from centre of post to centre of post [see footprint detail on page 89].



medio wrap



Top cross arm = looped graphic
Bottom cross arm = eyelet and spring clip

10.5kg

2000mm / 1500mm / 1200mm

PAGE 85



espresso



Top cross arm = looped graphic
Bottom cross arm = eyelet and spring clip

12.5kg

2000mm / 1500mm / 1200mm

PAGE 87



Q management



N/A

7kg

2m black belt

PAGE 90

primo original



SCAN ME FOR WEBPAGE



Robust fixings secure cross arms onto post.



Unique graphic attachment eliminates the need to stitch or eyelet graphics.



Wall mounted fixing bracket.



GRAPHIC PANEL SIZES

- **Finished size:**
830 x 975/1275/1775mm
- **Visual area:**
800 x 975/1275/1775mm
[15mm at the top and bottom are hidden by the hanger]

CODE	DESCRIPTION
91368	Primo café banner post and base unit
91369	1200mm Primo original café banner cross arm [set]
91543	1500mm Primo original café banner cross arm [set]
91370	2000mm Primo original café banner cross arm [set]
91527	Primo café banner wall fixing bracket [pair]



18kg

POST WEIGHT



features

- Slide graphics into the cross arms
- Primo Original cross arms eliminate the need to stitch or eyelet graphics
- Three cross arm width options – 2000mm, 1500mm and 1200mm
- Polished chrome finish
- Strong, durable cross arms and posts
- 18kg Primo post with stainless steel base cover
- Wall mounting bracket available

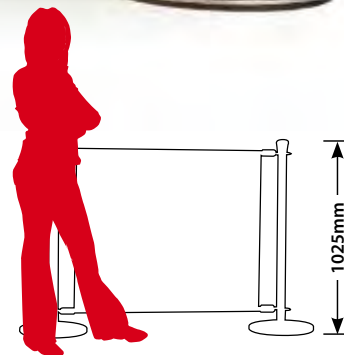

For more product information visit www.thedisplaydirectory.com



Fabric graphic looped over cross arm.



Polished stainless steel base.



Wall mounted fixing bracket.

primo wrap



SCAN ME FOR WEBPAGE



GRAPHIC PANEL SIZES

- **Finished size:**
1100 x 975/1275/1775mm
- **Visual area:**
900 x 975/1275/1775mm
[100mm bleed at the top and the bottom for the loops]

CODE	DESCRIPTION
91368	Primo café banner post and base unit
91744	1200mm Primo wrap café banner cross arm [set]
91745	1500mm Primo wrap café banner cross arm [set]
91746	2000mm Primo wrap café banner cross arm [set]
91527	Primo café banner wall fixing bracket [pair]

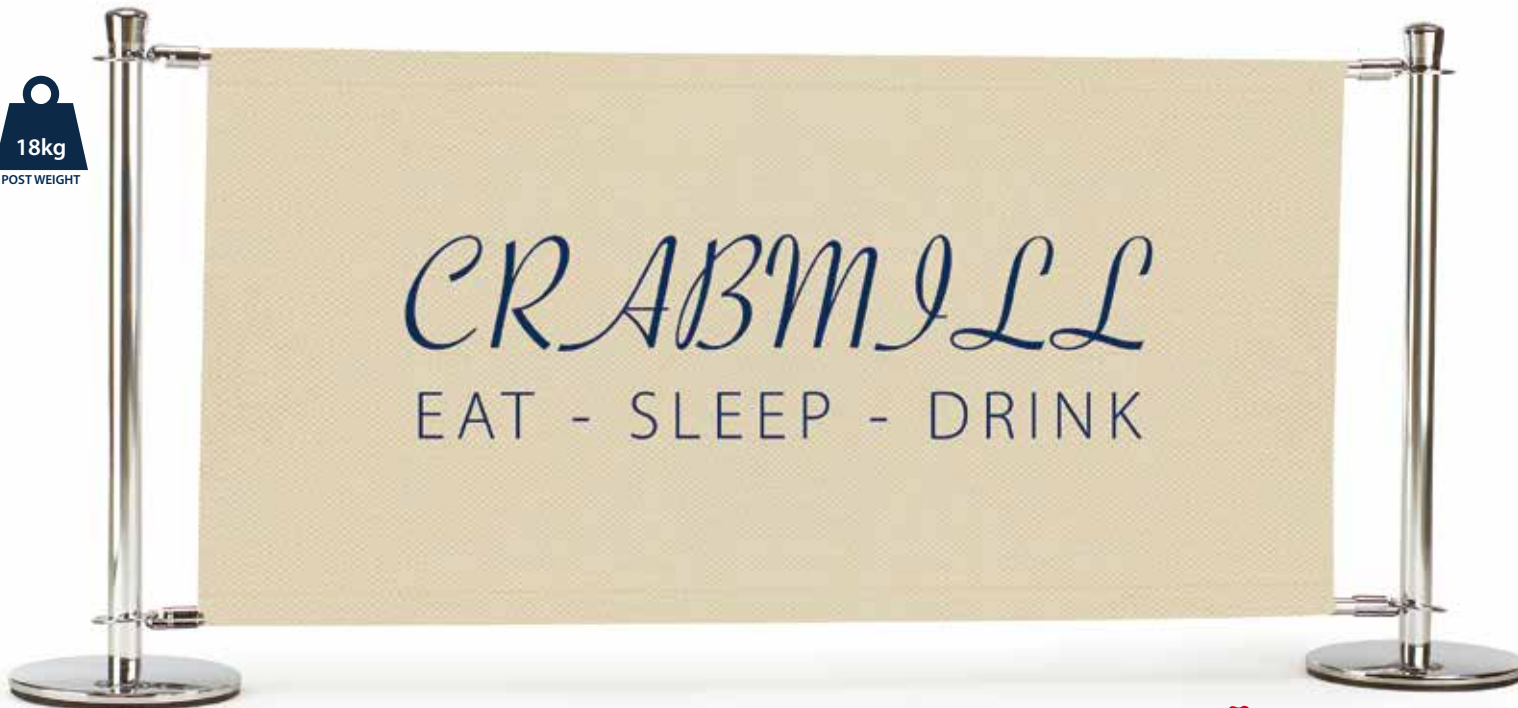

features

- Loop the graphics over the top and bottom cross arms
- Three cross arm width options – 2000mm, 1500mm and 1200mm
- Powder coated cross arms with chrome ends
- Strong, durable cross arms and posts
- Polished chrome finish on visible parts
- 18kg Primo post with stainless steel base cover
- Wall mounting bracket available

For more product information visit www.thedisplaydirectory.com

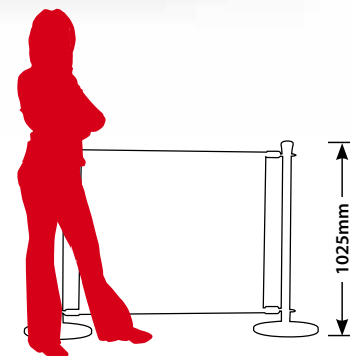

medio original



SCAN ME FOR WEBPAGE



Robust fixings secure cross arms onto post.



Unique graphic attachment eliminates the need to stitch graphics.



Wall mounted fixing bracket.



GRAPHIC PANEL SIZES

- **Finished size:**
835 x 975/1275/1775mm
- **Visual area:**
820 x 975/1275/1775mm
[top 15mm is hidden by the hanger]

CODE	DESCRIPTION
91567	Medio café banner post and base unit
91604	1200mm Medio original café banner cross arm and spring fittings
91603	1500mm Medio original café banner cross arm and spring fittings
91602	2000mm Medio original café banner cross arm and spring fittings
91605	Medio café banner wall mounted bracket [pair]
91568	Medio café banner spring clip [pair]

10.5kg
POST WEIGHT



features

- Slide graphics into the top cross arm
- Medio Original cross arms and spring clips eliminate the need to stitch graphics
- Three cross arm width options – 2000mm, 1500mm and 1200mm
- Polished chrome finish
- Strong, durable cross arm
- 10.5kg Medio post and base
- Wall mounting bracket available

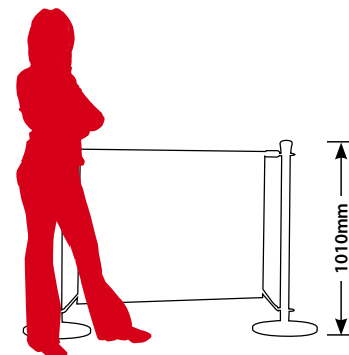

For more product information visit www.thedisplaydirectory.com

medio wrap



SCAN ME FOR WEBPAGE



Fabric graphic looped over cross arm.



Bottom of graphic attaches using a spring clip.



Wall mounted fixing bracket.



**WRAP-OVER
GRAPHICS**

GRAPHIC PANEL SIZES

- **Finished size:**
950 x 975/1275/1775mm
- **Visual area:**
850 x 975/1275/1775mm
[100mm bleed at the top for the loop]

CODE	DESCRIPTION
91567	Medio café banner post and base unit
91741	1200mm Medio wrap café banner cross arm and spring fittings
91742	1500mm Medio wrap café banner cross arm and spring fittings
91743	2000mm Medio wrap café banner cross arm and spring fittings
91605	Medio café banner wall mounted bracket [pair]
91568	Medio café banner spring clip [pair]



features

- Loop graphics over the top cross arm
- Three cross arm width options – 2000mm, 1500mm and 1200mm
- Powder coated cross arm with chrome ends
- Strong, durable cross arm
- Polished chrome finish on visible parts
- 10.5kg Medio post and base
- Wall mounting bracket available

For more product information visit www.thedisplaydirectory.com

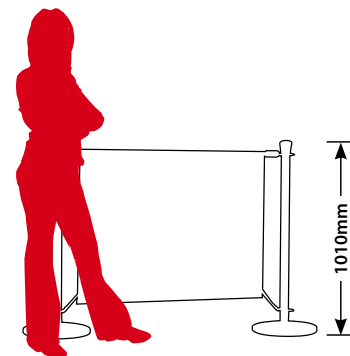



Robust fixings secure cross arms onto post.



Bottom of graphic attaches using a spring clip.



Wall mounted fixing bracket.

GRAPHIC PANEL SIZES

- **Finished size:**
900 x 975/1275/1775mm
- **Visual area:**
800 x 975/1275/1775mm
[100mm bleed at the top for the loop]

espresso



SCAN ME FOR WEBPAGE



CODE	DESCRIPTION
91663	Espresso café banner post and base unit
91563	1200mm Espresso café banner cross arm and spring fittings
91564	1500mm Espresso café banner cross arm and spring fittings
91565	2000mm Espresso café banner cross arm and spring fittings
91606	Espresso café banner wall mounted bracket [pair]
91566	Espresso café banner spring clip [pair]

12.5kg
POST WEIGHT



features

- Graphic bar allows for traditional loop graphic fixing
- Bottom of graphic attaches to post using a spring clip
- Three cross arm width options – 2000mm, 1500mm and 1200mm
- Black powder coated post and base - 12.5kg
- Strong, durable cross arm
- Wall mounting bracket available

For more product information visit www.thedisplaydirectory.com

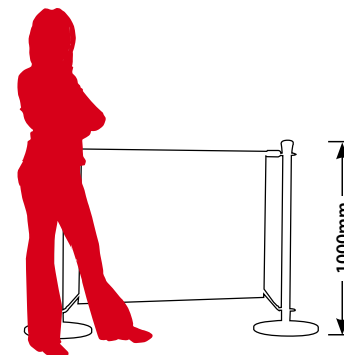

café banner footprints and dimensions

footprints

Primo Original/Primo Wrap

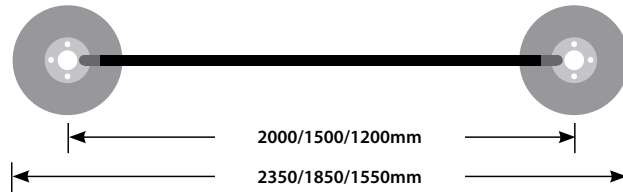

Medio Original/Medio Wrap

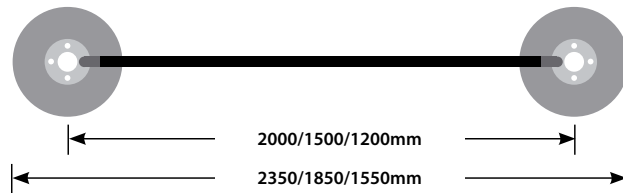

Espresso

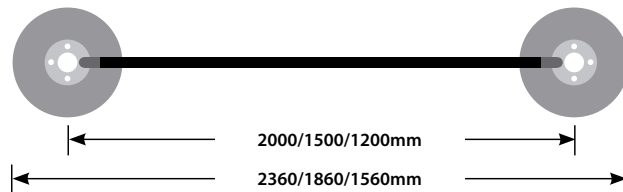

assembled dimensions

	PRIMO ORIGINAL	PRIMO WRAP	MEDIO ORIGINAL	MEDIO WRAP	ESPRESSO
Base diameter	350mm	350mm	350mm	350mm	360mm
Post height	1025mm	1025mm	1010mm	1010mm	1000mm
Height of base	35mm	35mm	25mm	25mm	75mm
Height to underside of bottom bar	100mm	100mm	N/A	N/A	N/A
Height to bottom edge of graphic	N/A	N/A	145mm	145mm	200mm

graphic panel sizes

Primo Original

Overall graphic area

• 975/1275/1775 [w] x 830 [h]mm

Visual graphic area

• 975/1275/1775 [w] x 800 [h]mm

Primo Wrap

Overall graphic area

• 975/1275/1775 [w] x 1100 [h]mm

Visual graphic area

• 975/1275/1775 [w] x 900 [h]mm

Medio Original

Overall graphic area

• 975/1275/1775 [w] x 835 [h]mm

Visual graphic area

• 975/1275/1775 [w] x 820 [h]mm

Medio Wrap

Overall graphic area

• 975/1275/1775 [w] x 950 [h]mm

Visual graphic area

• 975/1275/1775 [w] x 850 [h]mm

Espresso

Overall graphic area

• 975/1275/1775 [w] x 900 [h]mm

Visual graphic area

• 975/1275/1775 [w] x 800 [h]mm

Q management

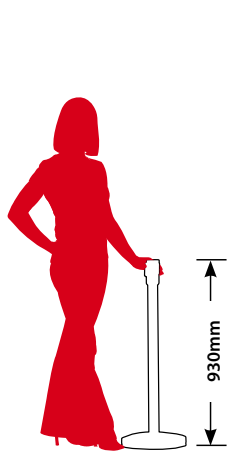

SCAN ME FOR WEBPAGE

Footprint: 320mm diameter

CODE	DESCRIPTION
30322	Q management / four post kit
30321	Q management / single post kit
91331	Q management wall mounted cartridge
91332	Q management wall mounted receiving bracket

features

- Pedestrian guidance system
- Polished chrome finish
- 2000mm retractable black webbing belt
- 4 way connectivity on each post
- Tamper proof locking mechanism
- 930mm high post and base – 7kg

N.B. For internal use only.

For more product information visit www.thedisplaydirectory.com



Wall receiving bracket.



Wall mounted cartridge.



Polished chrome finish.

product accessories

CODE	DESCRIPTION
BANNERSTAND ACCESSORIES	
30263/80233	Genie top hanger 800mm or 1000mm
30261	Genie/ Sigma/Sidewinder graphic change hook fastener
91294	Sigma/Zeta aluminium graphic guide
PB50	Sidewinder top hanger 600, 800, 1000, 1200 & 1500mm
POP-UP ACCESSORIES	
90868	Element/Advantage – hanging kit [Front or 'D' end]
90869	Element/Advantage – rigidising kit [Front or 'D' end]
90874	Advantage – hanging kit [Rear curve]
90875	Element/Advantage – rigidising kit [Rear curve]
91786	Advantage – hanging kit [front/rear straight]
91787	Advantage – rigidising kit [front/rear straight]
90867	Element/Advantage magnetic bar
390025/S	Element/Advantage – 30m roll of magnetic tape
PAVEMENT AND FORECOURT SIGNAGE ACCESSORIES	
90070	A0 replacement acetate for H2O swingmaster and 'A' frames
90069	A1 replacement acetate for H2O swingmaster and 'A' frames
90068	A2 replacement acetate for 'A' frames

CODE	DESCRIPTION
SNAP FRAME ACCESSORIES	
90070	A0 replacement acetate for gripframes
90069	A1 replacement acetate for gripframes
90068	A2 replacement acetate for gripframes
90067	A3 replacement acetate for information points and gripframes
90066	A4 replacement acetate for information points and gripframes
FUSION ACCESSORIES	
90678	Panel hanging strip for Fusion Versa panels
80294	Pre-cut sections of steel tape to suit one frame
390025/S	30m roll of magnetic tape for graphic panels
80290	2m post
80269	Oval base
80274	Post-to-frame joiner [pair]
80273	Fusion Rapid straight frame
80271	Fusion Versa straight frame
80272	Fusion Versa curved frame

boxed weights and dimensions

PRODUCT	BOXED WEIGHT (kg)	BOXED LENGTH (mm)	BOXED WIDTH (mm)	BOXED DEPTH (mm)
DISPLAY PRODUCTS				
BANNERSTANDS – INDOOR				
800mm Atom [Box of 6]	13.7	850	300	220
850mm Atom [Box of 6]	14.4	900	300	220
Zeta	1.95	850	105	105
600mm Neo	2.3	650	110	110
800mm Neo	2.6	850	110	110
850mm Neo	2.8	900	110	110
1000mm Neo	3.0	1050	110	110
1200mm Neo	3.4	1250	110	110
1500mm Neo	4.2	1550	110	110
800mm Genie	2.72	830	120	110
1000mm Genie	3.60	1030	120	110
800mm Sigma	4.50	900	225	105
1000mm Sigma	5.10	1100	225	105
Organic	5.00	970	205	150
600mm s/s Sidewinder	3.50	760	210	100
800mm s/s Sidewinder	4.30	890	210	100
1000mm s/s Sidewinder	5.00	1090	210	100
1200mm s/s Sidewinder	5.80	1290	210	100
1500mm s/s Sidewinder	7.60	1535	210	100
600mm d/s Sidewinder	4.00	760	210	100
800mm d/s Sidewinder	4.90	890	210	100
1000mm d/s Sidewinder	5.80	1090	210	100
1200mm d/s Sidewinder	6.60	1290	210	100
1500mm d/s Sidewinder	8.50	1535	210	100
Omega Fabric	6.20	905	175	165
Cobra	2.40	850	105	105
Illusion	10.80	1090	360	80

PRODUCT	BOXED WEIGHT (kg)	BOXED LENGTH (mm)	BOXED WIDTH (mm)	BOXED DEPTH (mm)
BANNERSTANDS – OUTDOOR				
Typhoon	17.60	1055	510	250
Cyclone	3.5	1165	420	205
Polar	6.60	1170	410	215
Outdoor A-banner – 2m	4.80	1170	165	165
Outdoor A-banner – 3m	5.60	1660	165	165
Vision – 2m single-sided	5.90	1490	140	80
Vision – 2m double-sided	9.00	1490	140	110
Vision – 3m single-sided	7.60	1490	140	110
Vision – 3m double-sided	12.60	1490	140	140
POP-UP SYSTEMS				
Element Pop-up Kit 3x3	24.5	947	663	385
Element Pop-up Kit 3x4	26.5	947	663	385
Advantage Curved 3x2	32	947	663	385
Advantage Curved 3x3	33	947	663	385
Advantage Curved 3x4	35	947	663	385
Advantage Straight 3x2	33	947	663	385
Advantage Straight 3x3	34	947	663	385
Advantage Straight 3x4	36	947	663	385
MODULAR DISPLAY				
Fusion Rapid – 1 Frame*	14.40	A. 340 B. 1165	A. 340 B. 220	A. 250 B. 205
Fusion Rapid – 2 Frame*	22.10	A. 340 B. 1165	A. 340 B. 220	A. 375 B. 315
Fusion Rapid – 3 Frame*	29.80	A. 340 B. 1165 C. 1090	A. 340 B. 220 C. 220	A. 500 B. 220 C. 95
Fusion Versa - 1 Frame Straight*	17.40	A. 340 B. 1165	A. 340 B. 220	A. 250 B. 205
Fusion Versa - 2 Frame Straight*	20.70	A. 340 B. 1165	A. 340 B. 220	A. 250 B. 205
Fusion Versa - 3 Frame Straight*	24.00	A. 340 B. 1165 C. 1090	A. 340 B. 220 C. 220	A. 250 B. 110 C. 190
Fusion Versa - 1 Frame Curved*	17.40	A. 340 B. 1165	A. 340 B. 220	A. 250 B. 205

PRODUCT	BOXED WEIGHT (kg)	BOXED LENGTH (mm)	BOXED WIDTH (mm)	BOXED DEPTH (mm)
Fusion Versa – 2 Frame Curved*	20.70	A. 340 B. 1165	A. 340 B. 220	A. 250 B. 205
Fusion Versa – 3 Frame Curved*	24.00	A. 340 B. 1165 C. 1090	A. 340 B. 220 C. 220	A. 250 B. 110 C. 190
Fusion Carry Case Kit A	8.00	1240	460	400
Fusion Carry Case Kit B*	14.60	A. 1240 B. 1240	A. 460 B. 460	A. 400 B. 400
Fusion Carry Case Kit C	9.00	1240	460	400
Fusion Carry Case Kit D*	14.80	A. 1240 B. 1240	A. 460 B. 460	A. 400 B. 400
Fusion Table Kit*	7.20	A. 1170 B. 650 C. 335	A. 115 B. 550 C. 100	A. 115 B. 70 C. 45
Fusion Literature Unit	1.50	315	240	60
PANEL SYSTEMS				
Folding Panel Kit - PK511	8.80	980	685	100
Folding Panel Kit - PK51	5.05	960	690	85
Folding Panel Kit - PK52	5.85	960	690	85
Panel and Pole Kit - PK53	7.50	960	680	100
Panel and Pole Kit - PK58	10.00	960	680	100
LITERATURE STANDS AND PROMOTION UNITS				
Media Compact Portrait	8.90	470	360	170
Media 4 Deluxe	7.20	530	370	340
In-store Promotion Unit	10.18	930	840	115
In-store Promotion Unit with header and pole set	12.50	930	840	115
Wheeled In-store Promotion Unit	13.40	925	845	117
Wheeled In-store Promotion Unit with header and pole set	12.50	930	840	115

* Product is packed in multiple boxes.

boxed weights and dimensions

PRODUCT	BOXED WEIGHT(kg)	BOXED LENGTH (mm)	BOXED WIDTH (mm)	BOXED DEPTH (mm)
LIGHTING AND CARRY EQUIPMENT				
Comet 85 Case	5.00	940	400	400
Comet 115 Case	6.00	1240	460	400
Meteor Case	11.69	1030	640	420
Graphic Carry Tube	1.32	1090	140	140
800mm Bannerstand Case	3.40	860	300	140
Lighting Case	3.20	585	380	210
Sirius/straight arm	0.65	470	80	65
Sirius/curved arm	0.65	450	160	60
Polaris light/with light fitting	0.60	470	80	65
Polaris light/bulldog clip	0.65	360	120	80
Vega light	1.15	505	150	60

SIGNAGE PRODUCTS

PAVEMENT AND FORECOURT SIGNAGE

Classic Sign Frame*	11.80	A. 935 B. 560	A. 585 B. 485	A. 85 B. 120
Switch Sign Frame*	11.80	A. 935 B. 560	A. 585 B. 485	A. 85 B. 120
Sign Wedge*	6.80	A. 905 B. 450	A. 435 B. 430	A. 10 B. 70
Small Traditional Chalkboard	10.00	1135	615	80
Large Traditional Chalkboard	11.50	1345	740	80
Small Rounded Chalkboard	10.00	1060	610	90
Large Rounded Chalkboard	13.00	1100	695	90
Folding Swing Sign	5.90	920	615	90
Aquabase*	11.00	A. 1150 B. 750	A. 760 B. 620	A. 90 B. 160
Aquabase Swap*	11.50	A. 1250 B. 750	A. 760 B. 620	A. 90 B. 160
A2 'A' Frame	6.80	1050	480	120
A1 'A' Frame	10.45	1250	650	120
A0 'A' Frame	16.95	1520	910	115
A1 H2O Swingmaster*	16.00	A. 840 B. 1020	A. 500 B. 670	A. 180 B. 75

PRODUCT	BOXED WEIGHT(kg)	BOXED LENGTH (mm)	BOXED WIDTH (mm)	BOXED DEPTH (mm)
A0 H2O Swingmaster*	26.10	A. 1070 B. 1360	A. 640 B. 930	A. 230 B. 75
A1 Icon*	25.00	A. 1255 B. 750	A. 775 B. 620	A. 90 B. 160
SNAP FRAME SIGNAGE				
A0 - 25mm gripframe	5.00	1250	900	25
A1 - 25mm gripframe	2.25	900	660	25
A2 - 25mm gripframe	1.32	660	480	25
A3 - 25mm gripframe	0.76	470	340	25
A4 - 25mm gripframe	0.50	360	260	25
A4 Information Point	3.75	1040	295	80
A3 Information Point	4.00	1040	370	80
A4 Telescopic Information Point	3.75	640	370	100
A3 Telescopic Information Point	4.25	860	430	100
I Pad holder	5.6	735	370	75
A1 Eos Lightbox	9.55	990	760	90
A2 Eos Lightbox	7.50	780	650	90
1200mm poster snapper	1.31	1250	100	90
1000mm poster snapper	1.18	1050	100	90
594mm poster snapper	0.86	650	100	90
420mm poster snapper	0.70	470	100	90
297mm poster snapper	0.51	350	100	90
210mm poster snapper	0.35	260	100	90

CAFÉ BANNER PRODUCTS

CAFÉ BANNERS AND BARRIER SYSTEMS

Primo Post & Base Unit*	18.00	A. 1040 B. 375	A. 115 B. 360	A. 115 B. 45
Primo Original Bars 1200mm	2.50	1160	90	45
Primo Original Bars 1500mm	3.25	1460	90	45
Primo Original Bars 2000mm	4.00	1960	90	45

PRODUCT	BOXED WEIGHT(kg)	BOXED LENGTH (mm)	BOXED WIDTH (mm)	BOXED DEPTH (mm)
Primo Wrap Bars 1200mm	1.50	1160	90	45
Primo Wrap Bars 1500mm	1.90	1460	90	45
Primo Wrap Bars 2000mm	2.50	1960	90	45
Primo Wall Fixing Bracket	0.80	215	108	55
Medio Post & Base Unit*	10.50	A. 1010 B. 370	A. 110 B. 370	A. 100 B. 70
Medio Original Bars 1200mm	1.50	1220	50	55
Medio Original Bars 1500mm	1.75	1510	50	55
Medio Original Bars 2000mm	2.50	2020	50	55
Medio Wrap Bars 1200mm	1.00	1220	45	45
Medio Wrap Bars 1500mm	1.20	1520	45	45
Medio Wrap Bars 2000mm	1.50	2020	45	45
Medio Wall Mounted Bracket [pair]	0.25	n/a	n/a	n/a
Espresso Post & Base Unit*	12.50	A. 1010 B. 370	A. 110 B. 370	A. 100 B. 160
Espresso Bars 1200mm	1.00	1220	45	45
Espresso Bars 1500mm	1.20	1520	45	45
Espresso Bars 2000mm	1.50	2020	45	45
Espresso Wall Mounted Bracket [pair]	0.25	n/a	n/a	n/a
'Q' Management 4 Post Kit*	27.60	A. 900 B. 350	A. 190 B. 350	A. 190 B. 300
'Q' Management Single Post Kit*	6.90	A. 900 B. 350	A. 95 B. 350	A. 95 B. 75
'Q' Management Wall Mounted Cartridge	0.50	135	95	95
'Q' Management Wall Mounted Receiving Bracket	0.10	90	85	30

* Product is packed in multiple boxes.

additional information

paper sizes

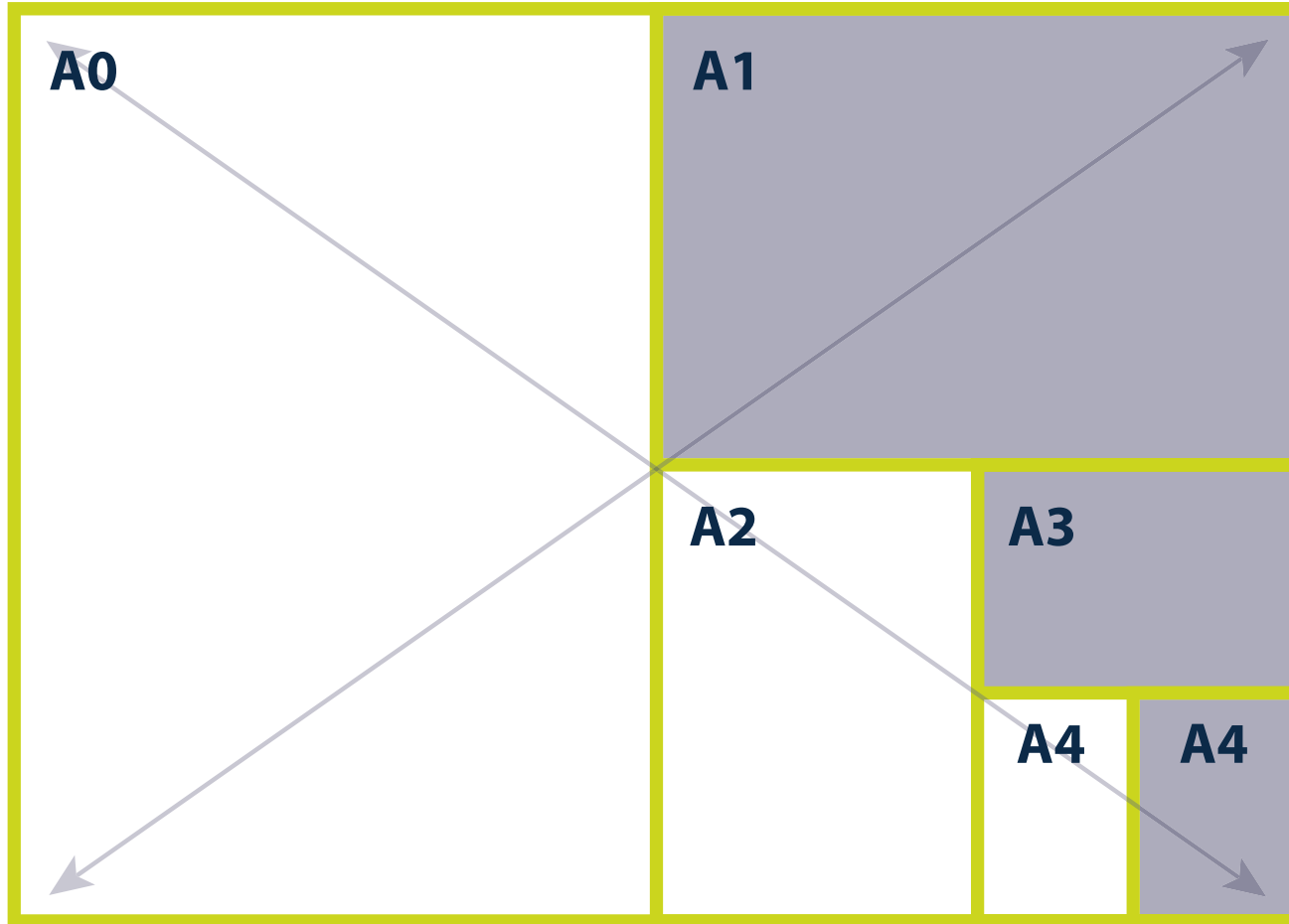

A4
210x297mm

Used with:

Gripframes,
Information Points,
Telescopic Information
Points and Poster Snappers.

A3
297x420mm

Used with:

Gripframes,
Information Points,
Telescopic Information
Points and Poster Snappers.

A2
420x594mm

Used with:

Switch, A-Frame,
Gripframe, Lightbox
and Poster Snapper.

A1
594x841mm

Used with:

Aquabase Swap, A-Frame,
Icon, H20 Swingmaster,
Lightbox, Poster Snapper.

A0
841x1189mm

Used with:

A-Frame,
H20 Swingmaster
and Gripframe.

spring **2014**
CATALOGUE



Due to continuous development it is possible that we may change a product specification without prior notice.

Feb
2014