

RE-USABLE  
**ELECTROSURGERY**  
CATALOGUE



+44 (0) 1453 752626



+44 (0) 1453 756750



sales@prima-medical.com



www.prima-medical.com



# We design and manufacture

## Monopolar



### Universal Fingerswitch

Our new range of fingerswitches which fit 2.4 and 4 mm electrodes

Page 2



### Eco-switch

A unique concept in environmentally friendly semi-disposable fingerswitches which fit 2.4 and 4mm electrodes.

Pages 3-4



### 60+, 100+ & 200+ Fingerswitches

Page 5



### Footswitch controlled handles

Footswitch controlled handles which fit 2.4 and 4mm electrodes

Page 6

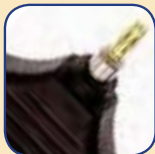

### Adaptors

Adaptors for all fingerswitches

Page 7



### Universal Monopolar Cable

One cable that fits most instruments!

Pages 17-18



### Monopolar Cables

A full range of monopolar cables to fit all instruments and generators

Pages 19-20



### AUTOCLABELS

Autoclave indicator labels

Pages 27-28



### Dispersive cables

Page 29

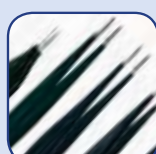

### Monopolar forceps

Pages 31-32

## Electrodes



### Blades

Page 9

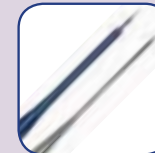

### Needles

Page 10



### Loops

Page 11



### Balls

Page 12

# electrosurgery accessories!

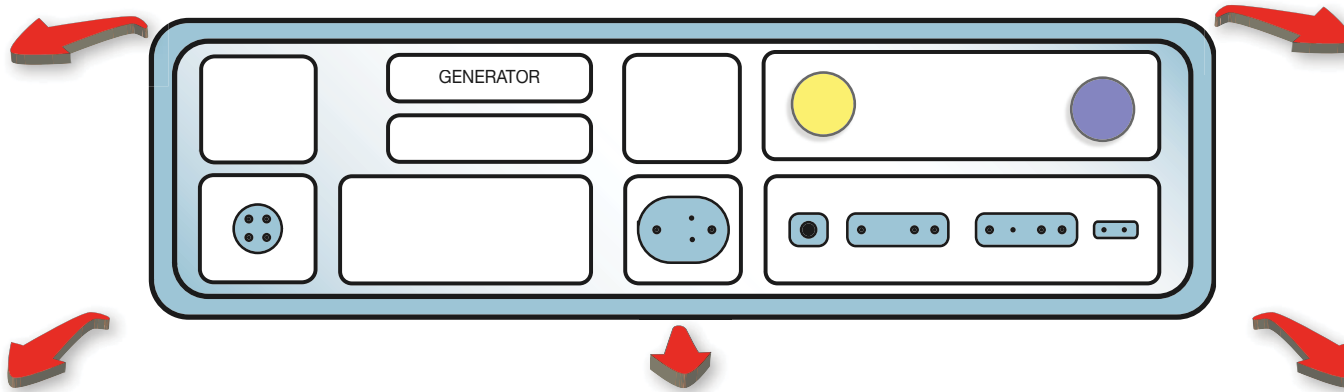

## Fibre light cables



Fibre light cables

Pages 13-15

## Footswitches



**Pneumatic Footswitch**

Pneumatically operated footswitch for bipolar generators

Page 43



Twin Footswitches

Pages 39-40



Single Footswitches

Pages 41-42

## Bipolar



**Universal Bipolar Cable**  
One cable that fits both the USA and European fitting instruments

Pages 21-22



**Bipolar Cables**

A full range of bipolar cables to fit all instruments and generators

Pages 23-26



**AUTOCLABELS**

Autoclave indicator labels

Pages 27-28



**Bipolar forceps**

Pages 33-36

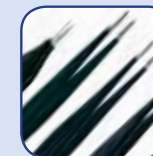

**NonStick**

bipolar forceps

Pages 37-38



+44 (0) 1453 752626



+44 (0) 1453 756750



sales@prima-medical.com



www.prima-medical.com





# Fingerswitches and Footswitch controlled handles



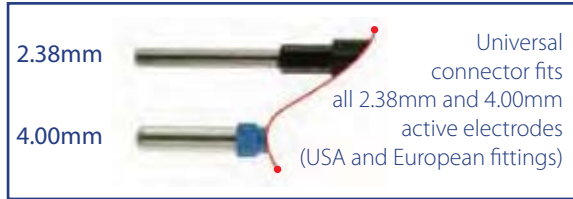

Ergonomic, non-slip grips on the underside



Tactile, double insulated switches



Colour coded **AUTOCLABEL** tag is used to monitor usage with the permanently attached **AUTOCLABEL** punch.

Patented design

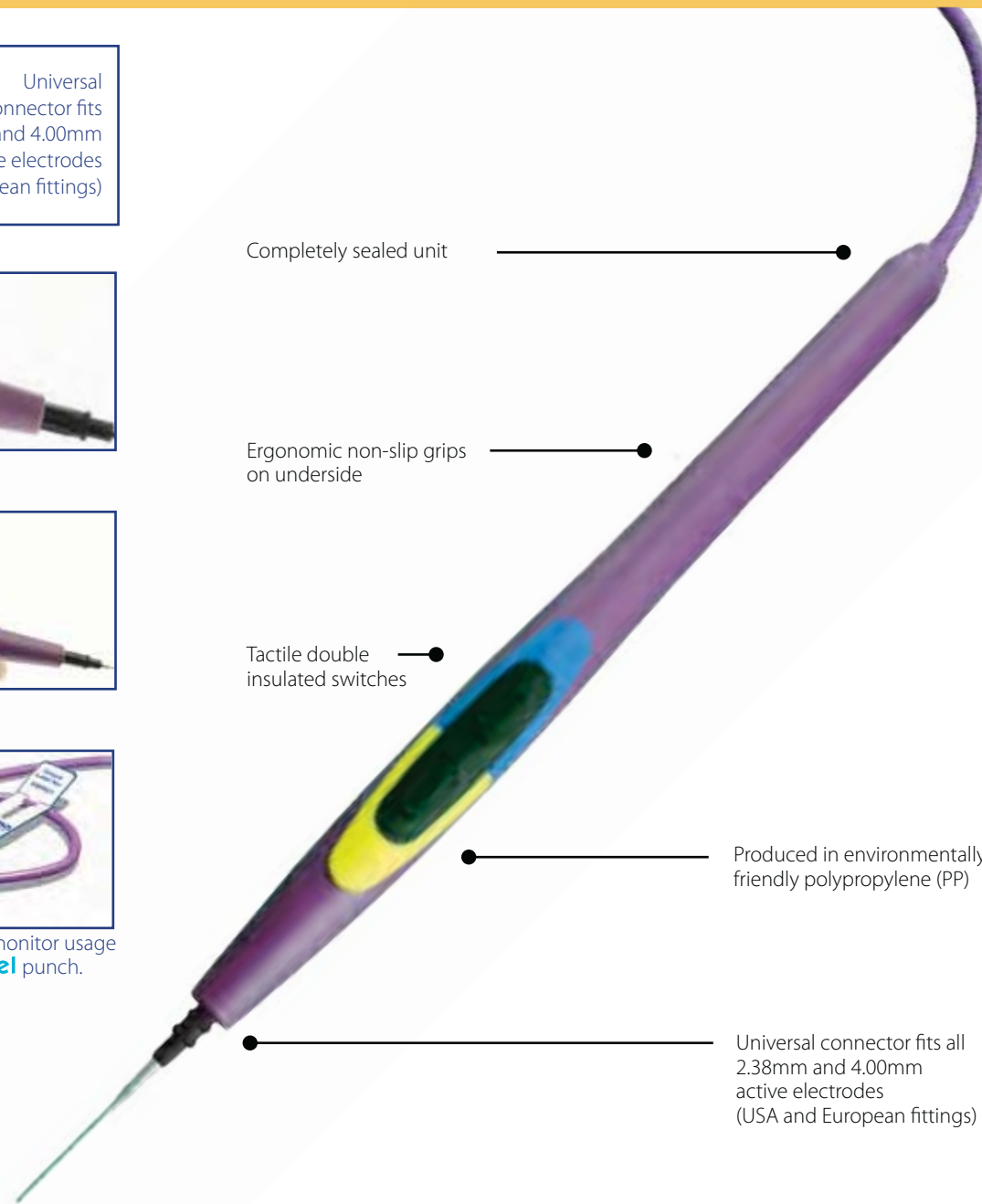

Completely sealed unit

Ergonomic non-slip grips on underside

Tactile double insulated switches

Produced in environmentally friendly polypropylene (PP)

Universal connector fits all 2.38mm and 4.00mm active electrodes (USA and European fittings)

## Ordering Details :

Pack of 5 universal fingerswitches with blade electrodes, AUTOCLABEL and punch. Each fingerswitch is autoclavable sixty times:

**PMS 2055**  
with 3m cable



Terminated with connector to fit:-  
Valleylab, BOWA  
Erbe ICC International  
Erbe VIO, Eschmann  
Conmed

**PMS 2056**  
with 5m cable

**PMS 2057**  
with 3m cable



Terminated with connector to fit:-  
**4mm (female)**  
Aesculap, Berchtold  
Erbe T Series,  
Huttinger, Martin,  
Micromed, Siemens  
Sutter BM780

**PMS 2058**  
with 5m cable

**PMS 2061**  
with 3m cable



Terminated with connector to fit:-  
**4mm** Erbe T-series

**PMS 2062**  
with 5m cable

**PMS 2059**  
with 3m cable



Terminated with connector to fit:-  
**5mm ACC (standard)**  
ICC, Erbe V10\*  
Karl Storz  
\*Depends on generator socket

**PMS 2060**  
with 5m cable



## The Eco-switch

- 5 Different coloured pencil handles, and
- 1 Reusable cable with **AUTOCLabel** and punch

Each Eco-switch pack contains one Eco-switch long life cable and five Eco-switch autoclavable electrosurgery handles with reusable blade electrodes. Simply replace each handle every thirty cleaning cycles - then the cable is used again.

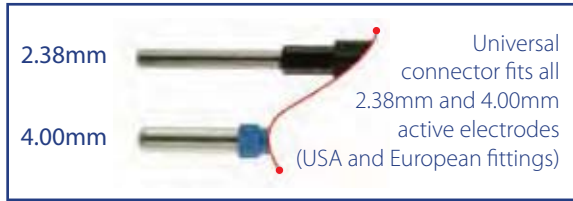

The Eco-**AUTOClabel** is colour coded to match the five different coloured pencil handles, each with thirty punchable dots to monitor usage with permanently attached **AUTOClabel** punch.

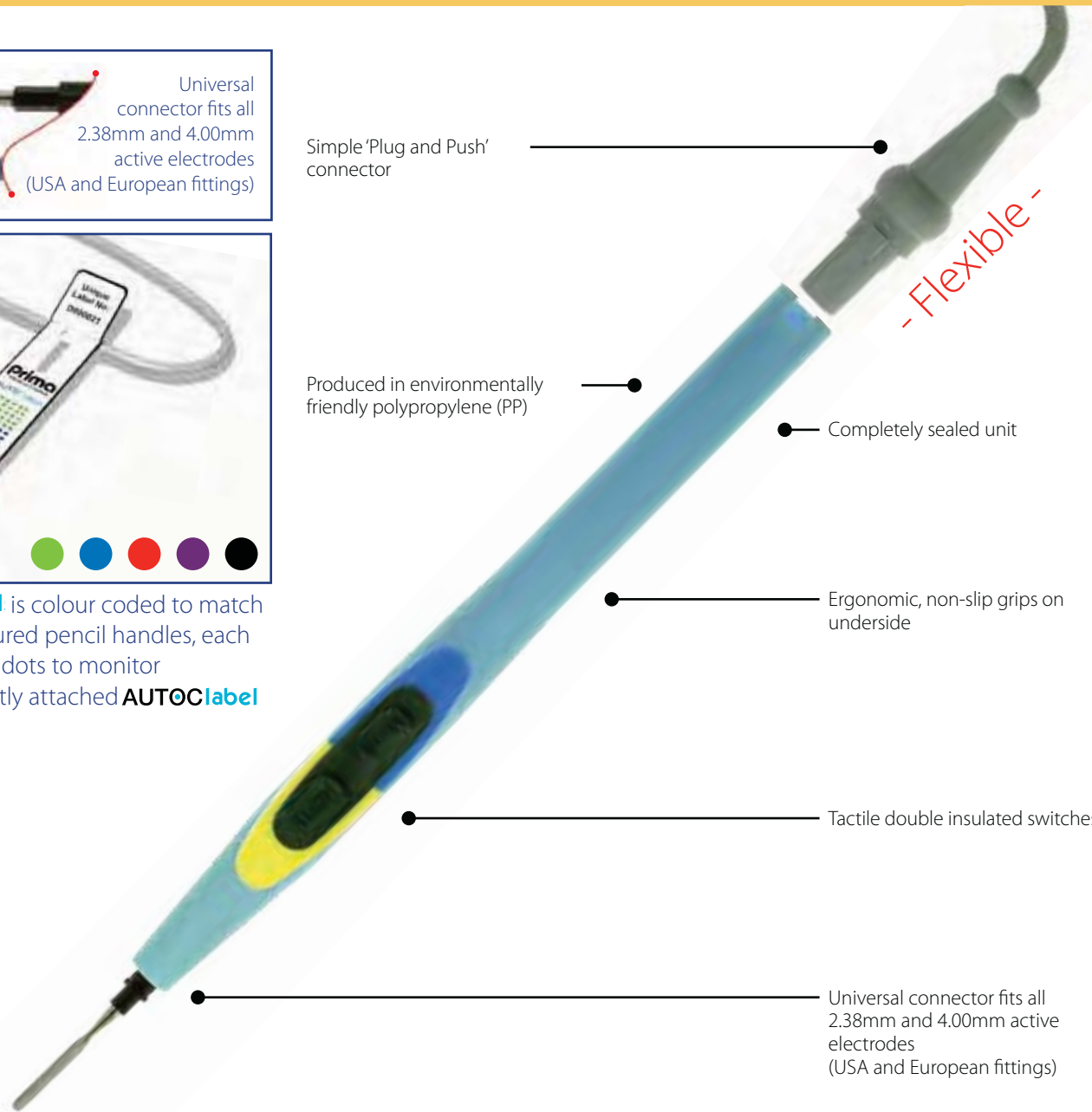

### Ordering Details:

Pack of 5 Eco-switches with blade electrodes, Eco cable, AUTOlabel and punch, terminated with electrosurgery generator connector: Each pencil is autoclavable 30 times, 150 in total

**PMS 2005**  
3m cable



Terminated with connector to fit: Valleylab, BOWA Erbe ICC International Erbe VIO, Eschmann Conmed

**PMS 2006**  
5m cable

**PMS 2007**  
3m cable



Terminated with connector to fit: 4mm (female) Aesculap, Berchtold Erbe T Series, Huttlinger, Martin, Micromed, Siemens Sutter BM780

**PMS 2008**  
5m cable

**PMS 2011**  
3m cable



Terminated with connector to fit: 4mm Erbe T-series

**PMS 2012**  
5m cable

**PMS 2009**  
3m cable



Terminated with connector to fit: 5mm ACC (standard) ICC, Erbe V10\*  
Karl Storz  
\*Depends on generator socket

**PMS 2010**  
5m cable

Patented design



+44 (0) 1453 752626



+44 (0) 1453 756750



sales@prima-medical.com



www.prima-medical.com





# 60+, 100+ & 200+ fingerswitches

## 3m

**PMS 550**  
200 Plus fingerswitch  
with blade electrode  
pack 1

plus  
**AUTOClabel:**

**PMS 750**  
100 Plus fingerswitch  
with blade electrode  
pack 5

plus  
**AUTOClabel:**

**PMS 950**  
60 Plus fingerswitch  
with blade electrode  
pack 5

plus  
**AUTOClabel:**

## 5m

**PMS 550/5**  
200 Plus fingerswitch  
with blade electrode  
pack 1

plus  
**AUTOClabel:**

**PMS 750/5**  
100 Plus fingerswitch  
with blade electrode  
pack 5

plus  
**AUTOClabel:**

**PMS 950/5**  
60 Plus fingerswitch  
with blade electrode  
pack 5

plus  
**AUTOClabel:**

## 200+



Autoclavable for a maximum of 200 cycles

## 100+



Autoclavable for a maximum of 100 cycles

## 60+



Autoclavable for a maximum of 60 cycles

## AUTOClabels



Autoclave tracking system



cable terminated  
with 3-pin plug

for adaptors see page 7



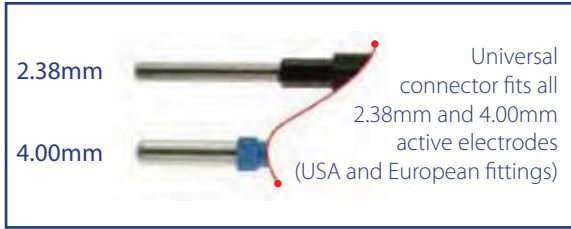

Ergonomically designed for precise control



Non slip grips - for safety



**AUTOCLABELS** autoclave tracking system



### Ordering Details:

Pack of 3 footswitch controlled handles with blade electrode, AUTOCLABEL and punch, terminated with electrosurgery generator connector:

**PMS 651**  
with 3m cable



Terminated with connector to fit:  
**4mm** Aesculap  
Berchtold  
Erbe T. Series  
Eschmann TD300, TD311, DS302  
Sutter BM780

**PMS 651/5**  
with 5m cable

**PMS 652**  
with 3m cable



Terminated with connector to fit:  
**8mm** Bard, Birtcher  
Bovie, Bowa  
Conmed, Eschmann  
Medtrex  
Valleylab

**PMS 652/5**  
with 5m cable

**PMS 654**  
with 3m cable



Terminated with connector to fit:  
**5mm** ACC (standard)  
ICC  
Erbe V10\*  
Karl Storz  
\*Depends on generator socket

**PMS 654/5**  
with 5m cable

**PMS 653**  
with 3m cable



Terminated with connector to fit:  
**4mm (female)**  
Aesculap,  
Berchtold  
Erbe T Series,  
Huttlinger  
Martin, Micromed  
Siemens  
Sutter BM780

**PMS 653/5**  
with 5m cable

# Fingerswitch adaptors

## 3-pin plug to Berchtold / Martin generators

### PMS 800

Pack of 1  
Fingerswitch adaptor



## 3-pin plug to Erbe ACC/ICC generators with 5mm pin

### PMS 850

Pack of 1  
Fingerswitch adaptor



## 3-pin plug to Erbe T series generators with 4mm pin

### PMS 860

Pack of 1  
Fingerswitch adaptor



## Connector from fingerswitch



cable terminated  
with 3-pin plug



**Safety guard:** Any break in the outer black insulation is highlighted by the yellow insulation layer below



**Safety Shield:** A slip-on sleeve designed to prevent potential arcing between the electrode and fingerswitch.



**Indicator grooves:** Enables sterilisation records to be maintained using the appropriate systems.



**Unique number:** Enables sterilisation record to be made of the product. (up to 25 uses)

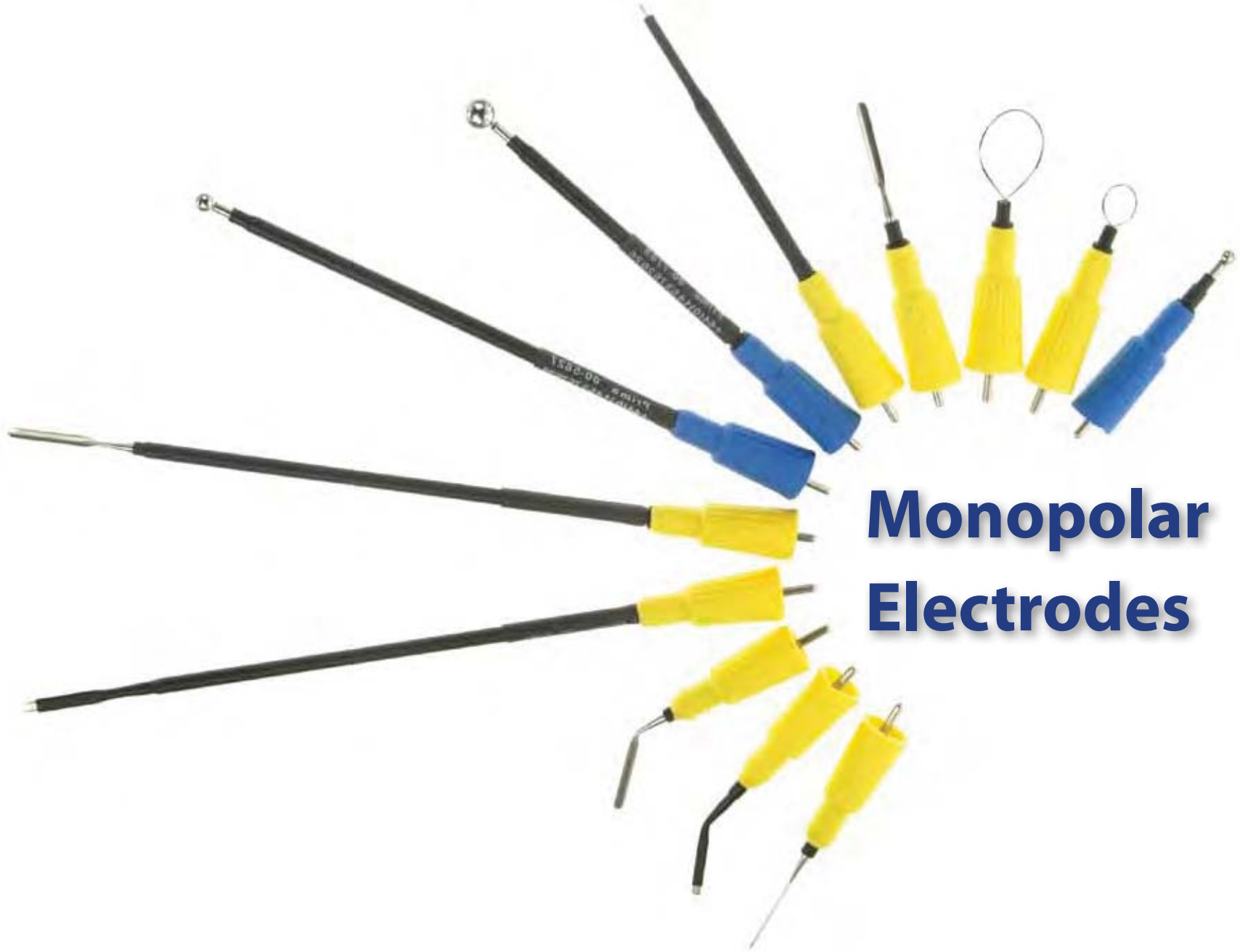

# Monopolar Electrodes



+44 (0) 1453 752626



+44 (0) 1453 756750



sales@prima-medical.com



www.prima-medical.com



# Blade electrodes

## PMS 1001

Pack of 5  
Blade electrode 70mm



## PMS 1011

Pack of 5  
Blade electrode 70mm active tip 3mm



## PMS 1003

Pack of 3  
Blade electrode 80mm

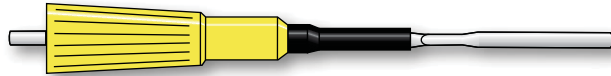

## PMS 1013

Pack of 3  
Blade electrode 80mm active tip 3mm

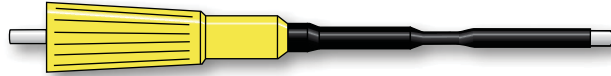

## PMS 1008

Pack of 3  
Blade electrode 100mm



## PMS 1009

Pack of 3  
Blade electrode 100mm active tip 3mm



## PMS 1005

Pack of 3  
Blade electrode 130mm



## PMS 1015

Pack of 3  
Blade electrode 130mm active tip 3mm



## PMS 1006

Pack of 3  
Blade electrode 180mm



## PMS 1016

Pack of 3  
Blade electrode 180mm active tip 3mm



## PMS 1014

Pack of 3  
Angled Blade electrode 80mm  
active tip 3mm



## PMS 1004

Pack of 3  
Angled Blade electrode 80mm



## PMS 1012

Pack of 5  
Angled Blade electrode 70mm  
active tip 3mm



## PMS 1002

Pack of 5  
Angled Blade electrode 70mm





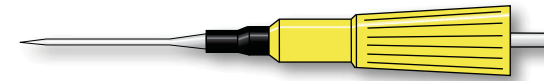
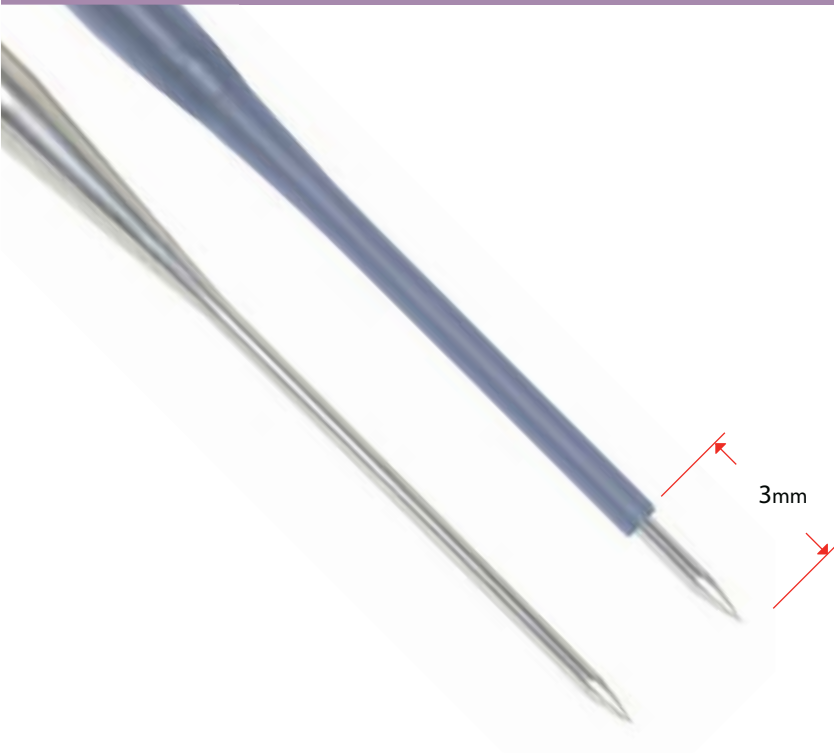

**PMS 2201**  
Pack of 5  
Needle 70mm

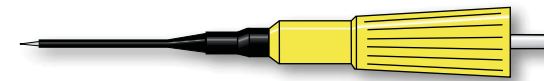

**PMS 2205**  
Pack of 5  
Insulated needle 70mm active tip 3mm

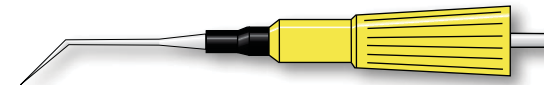

**PMS 2202**  
Pack of 5  
Angled needle 70mm



**PMS 2203**  
Pack of 3  
Needle 110mm



**PMS 2245**  
Pack of 3  
Insulated needle 110mm active tip 3mm



**PMS 2204**  
Pack of 3  
Angled needle 110mm



**PMS 2207**  
Pack of 3  
Needle 160mm



+44 (0) 1453 752626



+44 (0) 1453 756750



sales@prima-medical.com



www.prima-medical.com



# Loop electrodes

## PMS 1301

Pack of 5

Electrode 45mm + loop 3mm

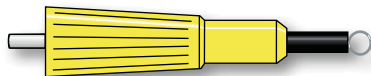

## PMS 1302

Pack of 5

Electrode 45mm + loop 6mm

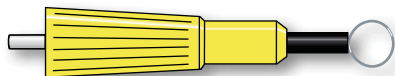

## PMS 1309

Pack of 5

Electrode 45mm + loop 8mm

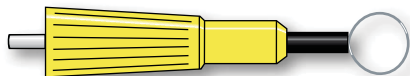

## PMS 1303

Pack of 5

Electrode 45mm + loop 10mm

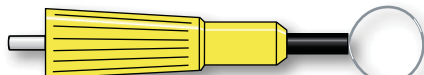

## PMS 1306

Pack of 5

Electrode 45mm + loop 12mm

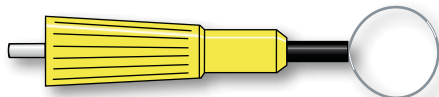

## PMS 1304

Pack of 5

Electrode 45mm + loop 15mm

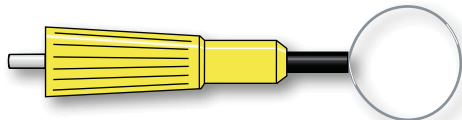

## PMS 1308

Pack of 5

Electrode 45mm + loop 20mm

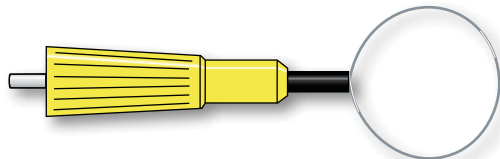

## PMS 1305

Pack of 3

Electrode 100mm + loop 6mm



## PMS 1311

Pack of 3

Electrode 100mm + loop 8mm



## PMS 1310

Pack of 3

Electrode 100mm + loop 10mm



## PMS 1312

Pack of 3

Electrode 100mm + loop 12mm



## PMS 1313

Pack of 3

Electrode 100mm + loop 15mm



## PMS 1314

Pack of 3

Electrode 100mm + loop 20mm



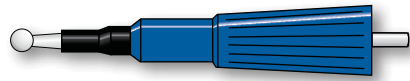

**PMS 1410**  
Pack of 5  
Electrode 50mm + ball 3mm

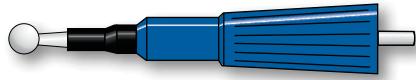

**PMS 1403**  
Pack of 5  
Electrode 50mm + ball 4mm



**PMS 1435**  
Pack of 5  
Electrode 50mm + ball 5mm



**PMS 1405**  
Pack of 5  
Electrode 50mm + ball 8mm



**PMS 1408**  
Pack of 3  
Electrode 110mm + ball 3mm



**PMS 1407**  
Pack of 3  
Electrode 110mm + ball 4mm



**PMS 1420**  
Pack of 3  
Electrode 110mm + ball 5mm



**PMS 1412**  
Pack of 3  
Electrode 110mm + ball 8mm



**PMS 1415**  
Pack of 3  
Electrode 150mm + ball 3mm



**PMS 1416**  
Pack of 3  
Electrode 150mm + ball 4mm



**PMS 1417**  
Pack of 3  
Electrode 150mm + ball 5mm



**PMS 1418**  
Pack of 3  
Electrode 150mm + ball 8mm



+44 (0) 1453 752626



+44 (0) 1453 756750



sales@prima-medical.com



www.prima-medical.com





## Coloured Fibre Light Cables



	<b>P</b> BS / ACMI Female	<b>Q</b> Wolf / Dyonics	<b>R</b> Storz / Olympus	<b>A</b> BS / ACMI Male
<b>A</b> ACMI British Standard	AP	AQ	AR	AA
<b>B</b> Wolf / Dyonics	BP	BQ	BR	BA
<b>C</b> Storz	CP	CQ	CR	CA
<b>E</b> Olympus	EP	EQ	ER	EA
<b>F</b> Pentax	FP	FQ	FR	FA



### Fibre light cables

#### Available cable length

- 1.8m Add 18 to code
- 2.3m Add 23 to code
- 3.0m Add 30 to code

#### Available fibre-light bundle diameter

- 3.5 mm Add 35 to code
- 4.9 mm Add 49 to code

#### Available fibre light cables colours

- B for Blue
- G for Green
- R for Red
- Y for Yellow
- GY for Grey

### Generate your own fibre optic cable codes

The codes listed left are the first part of your product code. To generate the second part, you need to know the length and diameter of the cable you require (see above), finally add the colour you wish (see above)

For example;

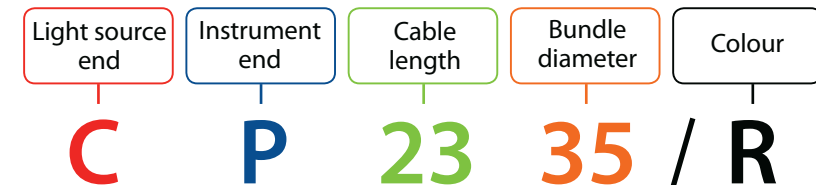

Product code: **CP2335/R**

NOT FOR USE WITH XENON LIGHT SOURCES WITHOUT HEAT FILTERS

# Coloured high flex, armoured fibre light cables

	PX BS / ACMI Female	QX Wolf / Dyonics	RX Storz / Olympus	AX BS / ACMI Male
<b>A</b> ACMI British Standard 	APX	AQX	ARX	AAX
<b>B</b> Wolf / Dyonics 	BPX	BQX	BRX	BAX
<b>C</b> Storz 	CPX	CQX	CRX	CAX
<b>E</b> Olympus 	EPX	EQX	ERX	EAX
<b>F</b> Pentax 	FPX	FQX	FRX	FAX

SUITABLE FOR USE WITH XENON LIGHT SOURCES



Armoured cables



Crush resistant

- For use with Xenon light sources
- high-flex armoured cables
- choice of colours - identify your department!

## Fibre light cables

### Available cable length

1.8m	Add 18 to code
2.3m	Add 23 to code
3.0m	Add 30 to code

### Available fibre-light bundle diameter

3.5mm	Add 35 to code
4.9mm	Add 49 to code

### Available fibre light cables colours

● B	for Blue
● G	for Green
● R	for Red
● Y	for Yellow
● GY	for Grey

### Generate your own fibre optic cable codes

The codes listed left are the first part of your product code. To generate the second part, you need to know the length and diameter of the cable you require (see above), finally add the colour you wish (see above)

For example;

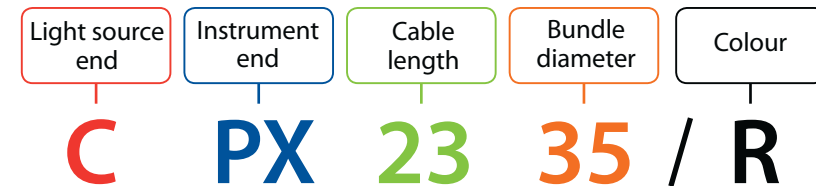

Product code: CPX2335/R

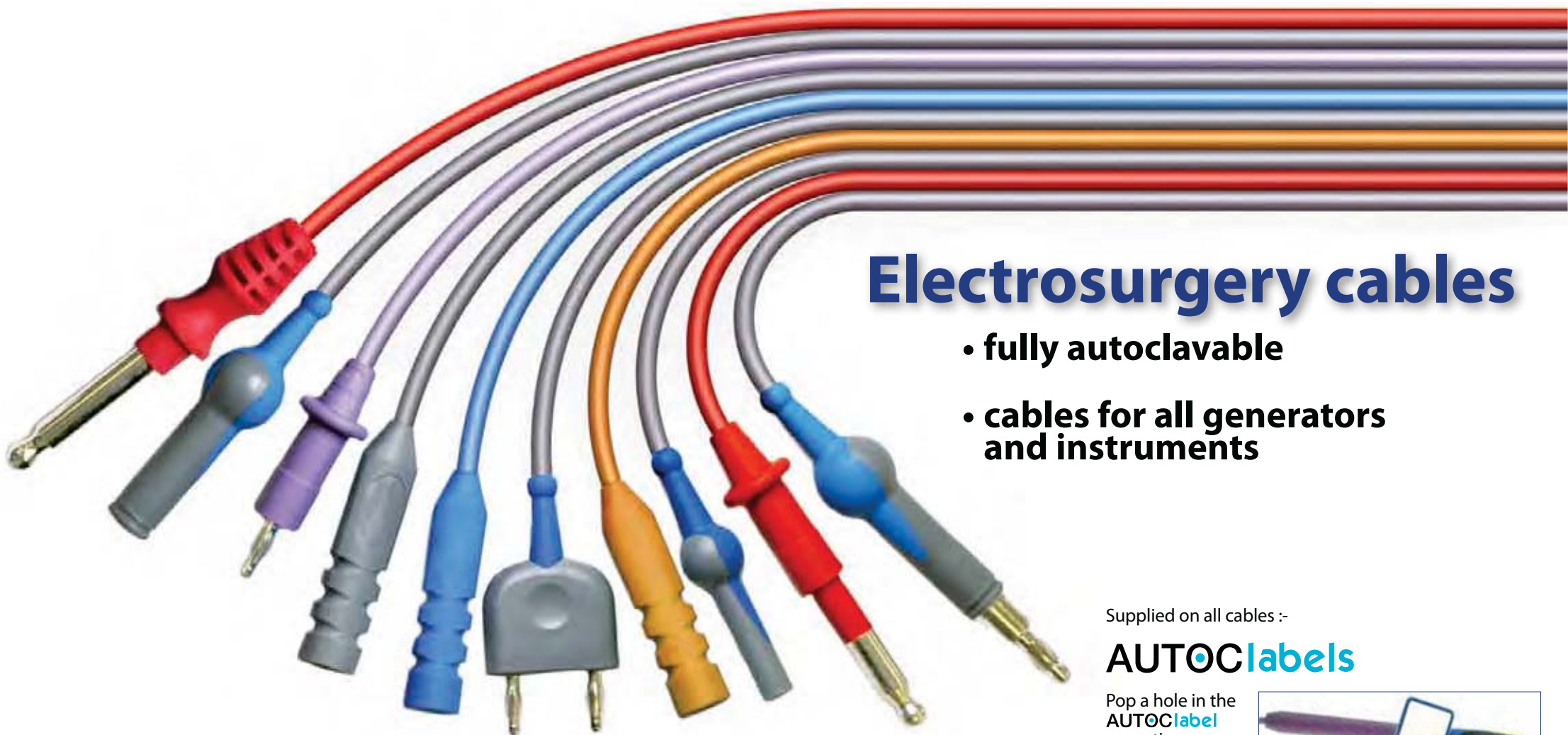

## Electrosurgery cables

- fully autoclavable
- cables for all generators and instruments

Supplied on all cables :-

### AUTOClabels

Pop a hole in the **AUTOClabel** every time the product is autoclaved with the permanently attached **AUTOClabel** punch.



PAGE  
28



+44 (0) 1453 752626



+44 (0) 1453 756750



sales@prima-medical.com



www.prima-medical.com





# Universal monopolar cables

One cable fits all and a choice of colours!  
Now you need only one cable  
No more connection problems!



**Safety sleeve** –see the breaks before they occur

- Double insulated cable
- Built-in cable restraints
- Highly flexible cable/connector.



## Generator connectors

4mm



B

8mm



C

Fits most male forcep ends



4.8mm Monopolar handles  
(foot controlled)



4.0mm Endoscopic

## Instrument connectors

Orange



B-50/O  
4m cable

C-50/O  
4m cable

Fuchsia



B-50/F  
4m cable

C-50/F  
4m cable

Purple



B-50/P  
4m cable

C-50/P  
4m cable

Blue



B-50/B  
4m cable

C-50/B  
4m cable



4.5 to 5.0mm Monopolar forceps



4.0mm Monopolar handle UK

## AUTOClabels

Pop a hole in the **AUTOClabels** every time the product is autoclaved with the permanently attached **AUTOClabels** punch.

See page 28



# Monopolar cables

		Instrument connectors	Olympus resectoscope (4mm female instrument socket)	3mm endoscopic socket Olympus, Cook instruments	US screw fitting Olsen
					
			<b>G</b>	<b>10</b>	<b>8</b>
<b>Generator connectors</b>					
4mm male	Aesculap Berchtold Erbe T. Series Eschmann TD300, TD311, DS302 Sutter BM780		<b>B-G</b> 3m cable <b>B-G/5</b> 5m cable	<b>B-10</b> 3m cable <b>B-10/5</b> 5m cable	<b>B-8</b> 3m cable <b>B-8/5</b> 5m cable
8mm	Bard Birtcher Bovie Bowa Conmed Eschmann Medtrex and Valleylab		<b>C-G</b> 3m cable <b>C-G/5</b> 5m cable	<b>C-10</b> 3m cable <b>C-10/5</b> 5m cable	<b>C-8</b> 3m cable <b>C-8/5</b> 5m cable
5mm	ACC (standard) ICC Erbe V10* Karl Storz *Depends on generator socket		<b>D-G</b> 3m cable <b>D-G/5</b> 5m cable	<b>D-10</b> 3m cable <b>D-10/5</b> 5m cable	<b>D-8</b> 3m cable <b>D-8/5</b> 5m cable
4mm female	Aesculap Berchtold Erbe T Series Huttinger Martin Micromed Siemens and Sutter BM780		<b>G-G</b> 3m cable <b>G-G/5</b> 5m cable	<b>G-10</b> 3m cable <b>G-10/5</b> 5m cable	<b>G-8</b> 3m cable <b>G-8/5</b> 5m cable

<p>4mm socket endoscopic instrument</p>  <p>7</p>	<p>Adult Storz resectoscope</p>  <p>6</p>	<p>Comeg 2mm pin fitting Wolf Storz pin fitting</p>  <p>4 (old 11)</p>	<p>Childs Storz resectoscope</p>  <p>3</p>	<p>UK 4.8mm socket shrouded safety connector</p>  <p>1</p>
--	--	---	--	---

<p>B-7 3m cable</p> <p>B-7/5 5m cable</p>	<p>B-6 3m cable</p> <p>B-6/5 5m cable</p>	<p>B-4 3m cable</p> <p>B-4/5 5m cable</p>	<p>B-3 3m cable</p> <p>B-3/5 5m cable</p>	<p>B-1 3m cable</p> <p>B-1/5 5m cable</p>
<p>C-7 3m cable</p> <p>C-7/5 5m cable</p>	<p>C-6 3m cable</p> <p>C-6/5 5m cable</p>	<p>C-4 3m cable</p> <p>C-4/5 5m cable</p>	<p>C-3 3m cable</p> <p>C-3/5 5m cable</p>	<p>C-1 3m cable</p> <p>C-1/5 5m cable</p>
<p>D-7 3m cable</p> <p>D-7/5 5m cable</p>	<p>D-6 3m cable</p> <p>D-6/5 5m cable</p>	<p>D-4 3m cable</p> <p>D-4/5 5m cable</p>	<p>D-3 3m cable</p> <p>D-3/5 5m cable</p>	<p>D-1 3m cable</p> <p>D-1/5 5m cable</p>
<p>G-7 3m cable</p> <p>G-7/5 5m cable</p>	<p>G-6 3m cable</p> <p>G-6/5 5m cable</p>	<p>G-4 3m cable</p> <p>G-4/5 5m cable</p>	<p>G-3 3m cable</p> <p>G-3/5 5m cable</p>	<p>G-1 3m cable</p> <p>G-1/5 5m cable</p>

## AUTOCLabels

Pop a hole in the **AUTOCLabels** every time the product is autoclaved with the permanently attached **AUTOCLabels** punch.

See page 28



These cables are for use with UK and Prima monopolar forceps

Pages 31-32



+44 (0) 1453 752626



+44 (0) 1453 756750



sales@prima-medical.com



www.prima-medical.com



0120

# Universal bipolar cables

## Fits US and European bipolar instruments

This innovative universal bipolar cable fits both US and European fitting bipolar instruments

- Always have the correct cable
- Save money by having a single product
- Reduce stock level requirements



## Generator connectors

Conmed



L

L-30  
4m cable

Dolley  
EMC



M

M-30  
4m cable

Erbe, Siemens  
Sutter BM50



P

P-30  
4m cable

## Instrument connector

Universal





# Universal bipolar cables

## AUTOCLabels

Pop a hole in the **AUTOCLabels** every time the product is autoclaved with the permanently attached **AUTOCLabels** punch.

See page 28



<p>2mm Martin, Aesculap, Integra, Wolf, Berchtold, Sutter BM780</p>  <p><b>Q</b></p>	<p>Older Eschmann 300 series (Lemo)</p>  <p><b>R</b></p>	<p>Twin 4mm pin, Erbe Int. Eschmann, Alsa MCD series</p>  <p><b>S</b></p>	<p>Aesculap (Older models GK50)</p>  <p><b>T</b></p>	<p>Storz</p>  <p><b>U</b></p>	<p>Bowa, EMC, Erbe Int. Ethicon, Lamidey, Valleylab Coa comp, Olympus, Soering</p>  <p><b>V</b> (old N)</p>	<p>Codman CMC11</p>  <p><b>W</b></p>	<p>Valleylab (autobipolar models only)</p>  <p><b>Y</b></p>
<p><b>Q-30</b> 4m cable</p>	<p><b>R-30</b> 4m cable</p>	<p><b>S-30</b> 4m cable</p>	<p><b>T-30</b> 4m cable</p>	<p><b>U-30</b> 4m cable</p>	<p><b>V-30</b> 4m cable</p>	<p><b>W-30</b> 4m cable</p>	<p><b>Y-30</b> 4m cable</p>

# Specialist bipolar cables

## AUTOClabels



Autoclave tracking system

## Generator connectors

Conmed



L

Dolley  
EMC



M

Erbe, Siemens  
Sutter BM50



P

2mm Martin, Aesculap, Wolf  
Berchtold, Sutter BM780



Q

## Instrument connectors

European fitting



12

L-12  
3m cable

L-12/5  
5m cable

M-12  
3m cable

M-12/5  
5m cable

P-12  
3m cable

P-12/5  
5m cable

Q-12  
3m cable

Q-12/5  
5m cable

Karl Storz



14

L-14  
3m cable

L-14/5  
5m cable

M-14  
3m cable

M-14/5  
5m cable

P-14  
3m cable

P-14/5  
5m cable

Q-14  
3m cable

Q-14/5  
5m cable

R Wolf



15

L-15  
3m cable

L-15/5  
5m cable

M-15  
3m cable

M-15/5  
5m cable

P-15  
3m cable

P-15/5  
5m cable

Q-15  
3m cable

Q-15/5  
5m cable

USA twin pin (straight)



16

L-16  
3m cable

L-16/5  
5m cable

M-16  
3m cable

M-16/5  
5m cable

P-16  
3m cable

P-16/5  
5m cable

Q-16  
3m cable

Q-16/5  
5m cable

USA twin pin (angled)



16A

L-16A  
3m cable

L-16A/5  
5m cable

M-16A  
3m cable

M-16A/5  
5m cable

P-16A  
3m cable

P-16A/5  
5m cable

Q-16A  
3m cable

Q-16A/5  
5m cable

Older Eschmann 300 series (Lemo)   <b>R</b>	Twin 4mm pin, Erbe Int. Eschmann, Alsa MCD series   <b>S</b>	Aesculap (Older models GK50)   <b>T</b>	Storz   <b>U</b>	Bowa, EMC, Erbe Int. Ethicon, Lamidey, Valleylab Coa comp, Olympus, Soering   <b>V (old N)</b>	Codman CMC11   <b>W</b>	Valleylab (autobipolar models only)   <b>Y</b>	Conmed (handswitching bipolar forceps)   <b>J</b>
R-12 3m cable  R-12/5 5m cable	S-12 3m cable  S-12/5 5m cable	T-12 3m cable  T-12/5 5m cable	U-12 3m cable  U-12/5 5m cable	V-12 3m cable  V-12/5 5m cable	W-12 3m cable  W-12/5 5m cable	Y-12 3m cable	N/A
R-14 3m cable  R-14/5 5m cable	S-14 3m cable  S-14/5 5m cable	T-14 3m cable  T-14/5 5m cable	U-14 3m cable  U-14/5 5m cable	V-14 3m cable  V-14/5 5m cable	W-14 3m cable  W-14/5 5m cable	N/A	N/A
R-15 3m cable  R-15/5 5m cable	S-15 3m cable  S-15/5 5m cable	T-15 3m cable  T-15/5 5m cable	U-15 3m cable  U-15/5 5m cable	V-15 3m cable  V-15/5 5m cable	W-15 3m cable  W-15/5 5m cable	N/A	N/A
R-16 3m cable  R-16/5 5m cable	S-16 3m cable  S-16/5 5m cable	T-16 3m cable  T-16/5 5m cable	U-16 3m cable  U-16/5 5m cable	V-16 3m cable  V-16/5 5m cable	W-16 3m cable  W-16/5 5m cable	Y-16 3m cable	N/A
R-16A 3m cable  R-16A/5 5m cable	S-16A 3m cable  S-16A/5 5m cable	T-16A 3m cable  T-16A/5 5m cable	U-16A 3m cable  U-16A/5 5m cable	V-16A 3m cable  V-16A/5 5m cable	W-16A 3m cable  W-16A/5 5m cable	Y-16A 3m cable	N/A

# Specialist bipolar cables

## AUTOClabels



Autoclave tracking system

## Generator connectors

Conmed



L

Dolley EMC



M

Erbe, Siemens Sutter BM50



P

Martin, Aesculap, Wolf Berchtold, Sutter BM780



Q

## Instrument connectors

Aesculap (old style))



17

L-17  
3m cable

L-17/5  
5m cable

M-17  
3m cable

M-17/5  
5m cable

P-17  
3m cable

P-17/5  
5m cable

Q-17  
3m cable

Q-17/5  
5m cable

Conmed handswitching forceps



18

N/A

N/A

N/A

N/A

Storz/Spectrum (small Fischer plug)



20

L-20  
3m cable

L-20/5  
5m cable

M-20  
3m cable

M-20/5  
5m cable

P-20  
3m cable

P-20/5  
5m cable

Q-20  
3m cable

Q-20/5  
5m cable

Ethicon bipolar scissors



22

L-22  
3m cable

L-22/5  
5m cable

M-22  
3m cable

M-22/5  
5m cable

P-22  
3m cable

P-22/5  
5m cable

Q-22  
3m cable

Q-22/5  
5m cable

Universal (USA & European fittings )



30

L-30  
4m cable

M-30  
4m cable

P-30  
4m cable

Q-30  
4m cable

See page 22



Older Eschmann 300 series (Lemo)	Twin 4mm pin, Erbe Int., Eschmann, Alsa MCD series	Aesculap (Older models GK50)	Storz	Bowa, EMC, Erbe Int. Ethicon, Lamidey, Valleylab Coa comp, Olympus, Soering	Codman CMC11	Valleylab (autobipolar models only)	Conmed (handswitching bipolar forceps)
 <b>R</b>	 <b>S</b>	 <b>T</b>	 <b>U</b>	 <b>V</b> (old N)	 <b>W</b>	 <b>Y</b>	 <b>J</b>
R-17 3m cable  R-17/5 5m cable	S-17 3m cable  S-17/5 5m cable	T-17 3m cable  T-17/5 5m cable	U-17 3m cable  U-17/5 5m cable	V-17 3m cable  V-17/5 5m cable	W-17 3m cable  W-17/5 5m cable	N/A	N/A
N/A	N/A	N/A	N/A	N/A	N/A	N/A	J-18 3m cable  J-18/5 5m cable
R-20 3m cable  R-20/5 5m cable	S-20 3m cable  S-20/5 5m cable	T-20 3m cable  T-20/5 5m cable	U-20 3m cable  U-20/5 5m cable	V-20 3m cable  V-20/5 5m cable	W-20 3m cable  W-20/5 5m cable	N/A	N/A
R-22 3m cable  R-22/5 5m cable	S-22 3m cable  S-22/5 5m cable	T-22 3m cable  T-22/5 5m cable	U-22 3m cable  U-22/5 5m cable	V-22 3m cable  V-22/5 5m cable	W-22 3m cable  W-22/5 5m cable	N/A	N/A
R-30 4m cable	S-30 4m cable	T-30 4m cable	U-30 4m cable	V-30 4m cable	W-30 4m cable	Y-30 4m cable	N/A



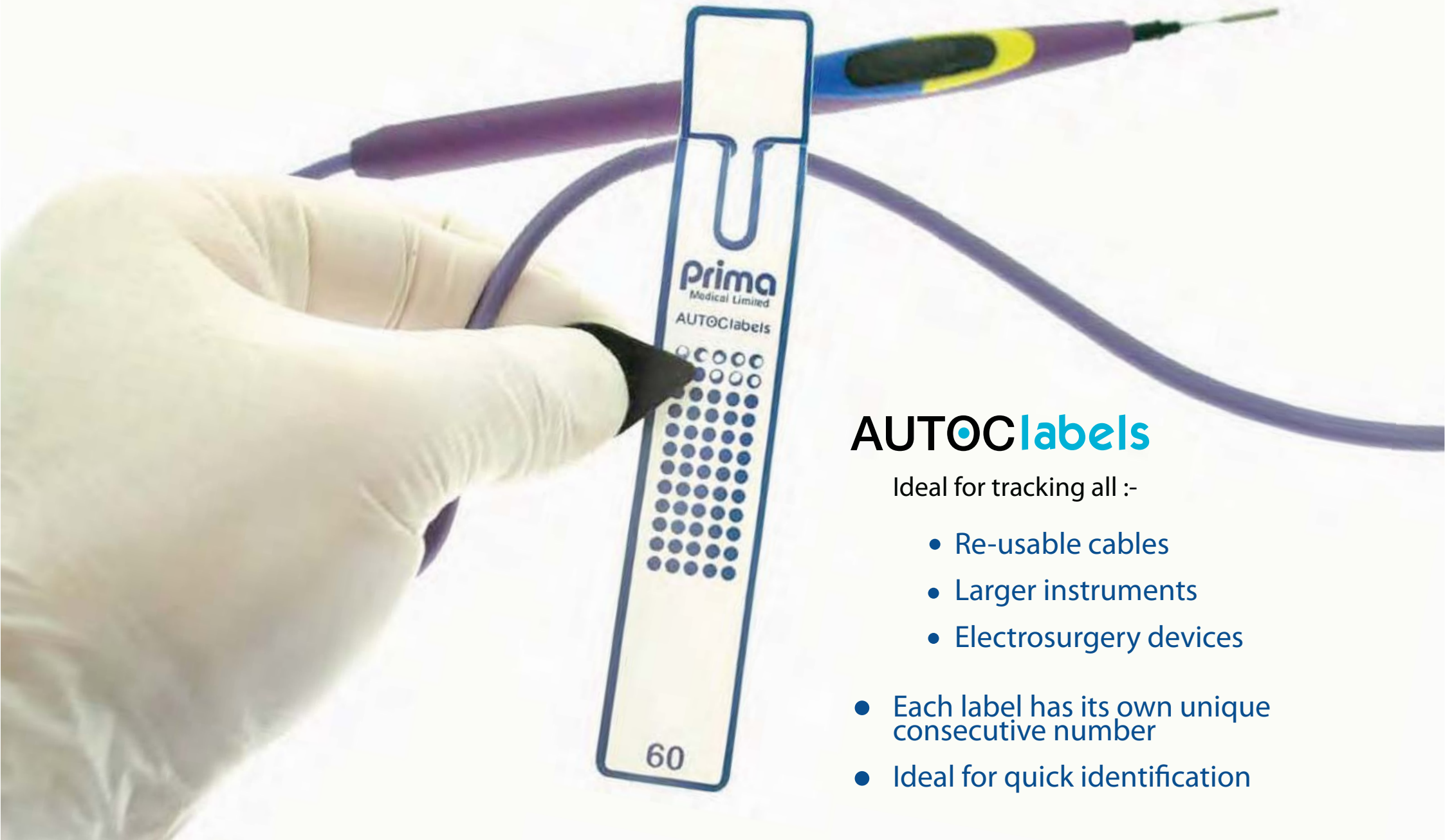

## AUTOClabels

Ideal for tracking all :-

- Re-usable cables
- Larger instruments
- Electrosurgery devices
- Each label has its own unique consecutive number
- Ideal for quick identification

# AUTOClabels - autoclave tracking system

## Simple!

It is easy to see and monitor product usage

- Pop a hole in the **AUTOClabel** every time the product is autoclaved with the permanently attached **AUTOClabel** punch or
- Track your product's autoclave history by using the unique label number printed at the top of each **AUTOClabel** tag or
- Use the blank **AUTOClabel** to apply your own barcode.

The **AUTOClabel** punch & label are easy to attach to the product, no tools needed, just clip on

No tie needed - Just push and lock the punch on the cable and the label just feeds back into itself – takes seconds!

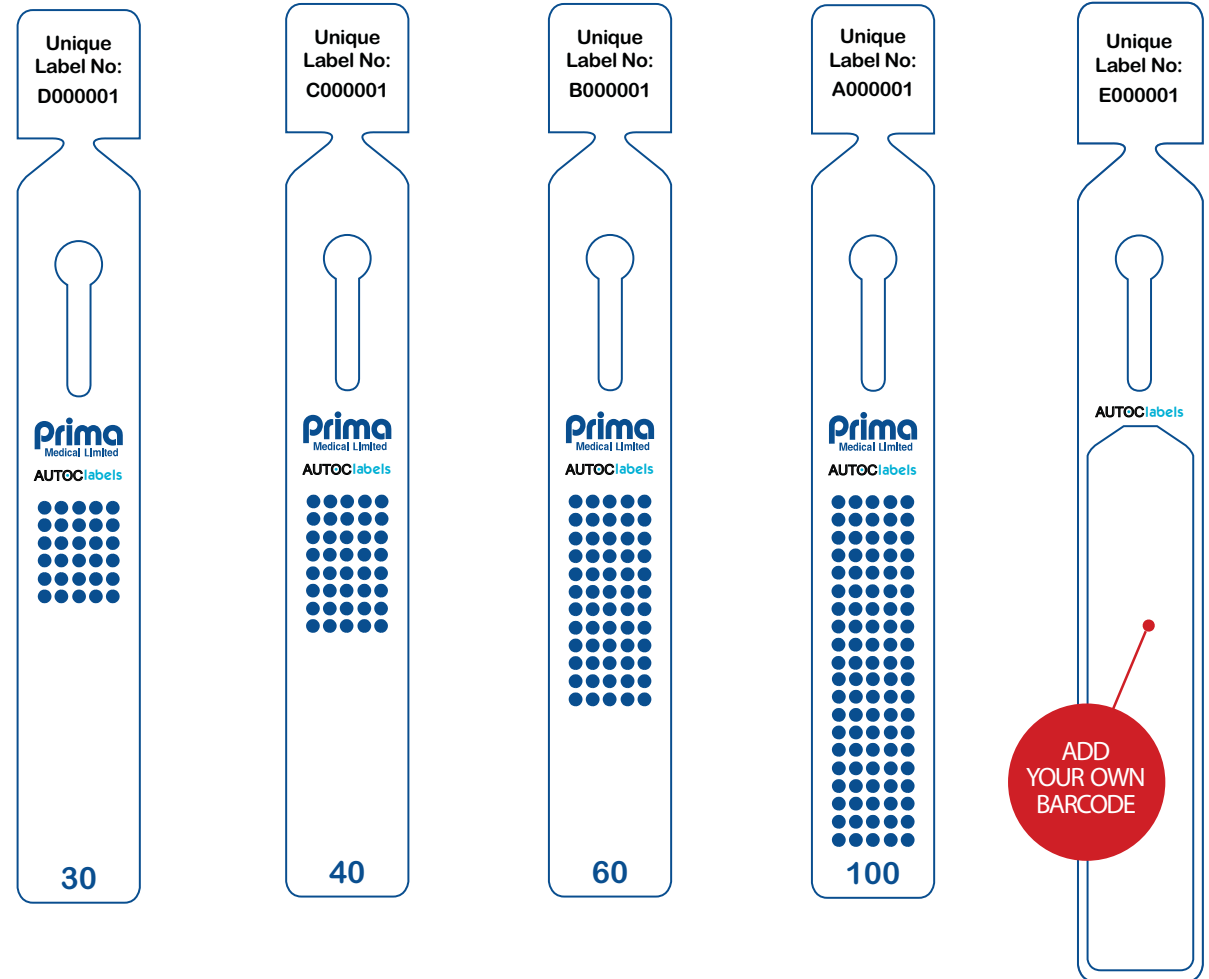

<p><b>ACL30</b> Autoclave cycles 30</p> <p>Pack 100 Punch and label sets</p>	<p><b>ACL40</b> Autoclave cycles 40</p> <p>Pack 100 Punch and label sets</p>	<p><b>ACL60</b> Autoclave cycles 60</p> <p>Pack 100 Punch and label sets</p>	<p><b>ACL100</b> Autoclave cycles 100</p> <p>Pack 100 Punch and label sets</p>	<p><b>ACL000</b> Blank for barcode</p>
--	--	--	--	--



# Dispersive cables



## Unique !

- Autoclavable
- Easy clean cables

### Generator connectors

	Valleylab (old generation)	Erbe ACC/ACC Erbe T Series Erbe VIO	Alsa/ Bard / Berchtold Bovie-Aaron 950, 1200 Eschmann TD400, TD800 Martin / Meditom	GU Eschmann 300 series	Valleylab SSE2 K, L and SSE3 Conmed	Aspen/ Bowa / Valleylab Erbe to 2.5 split-pad Conmed / Petas 500,600 Bovie-Aaron 1250,2250,3250
						
	DE1553 3m cable	DE1523 3m cable	DE1503 3m cable	DE1513 3m cable	DE1533 3m cable	DE1543 3m cable
	DE1555 5m cable	DE1525 5m cable	DE1505 5m cable	DE1515 5m cable	DE1535 5m cable	DE1545 5m cable

### Dispersive plate connector



Fits standard 25mm wide  
dispersive plate





## Monopolar & Bipolar forceps



+44 (0) 1453 752626



+44 (0) 1453 756750



sales@prima-medical.com



www.prima-medical.com



# Monopolar forceps

## PMS 14-7007

Pack of 1  
Serrated dissecting forceps  
Adson 100mm + tip 2mm  
Terminated with UK 4.8mm pin



## PMS 14-7000

Pack of 1  
Serrated forceps  
Adson 125mm + tip 2mm  
Terminated with UK 4.8mm pin



## PMS 14-7012

Pack of 1  
Serrated dissecting forceps  
McIndoe 150mm + tip 2mm  
Terminated with UK 4.8mm pin



## PMS 14-7002

Pack of 1  
Serrated forceps  
McIndoe 150mm + tip 2mm  
Terminated with UK 4.8mm pin



## PMS 14-7022

Pack of 1  
Serrated half teeth dissecting forceps  
150mm + tip 2mm  
Terminated with UK 4.8mm pin



## PMS 14-7014

Pack of 1  
Serrated dissecting forceps  
180mm + tip 2mm  
Terminated with UK 4.8mm pin



## PMS 14-7004

Pack of 1  
Serrated forceps  
Waugh 180mm + tip 2mm  
Terminated with UK 4.8mm pin



## PMS 14-7094

Pack of 1  
Serrated half teeth forceps  
Waugh 180mm + tip 2mm  
Terminated with UK 4.8mm pin

## PMS 14-7001

Pack of 1  
Serrated forceps  
Adson 180mm + tip 2mm  
Terminated with UK 4.8mm pin

## PMS 14-7005

Pack of 1  
Serrated half teeth forceps  
Adson 180mm + tip 2mm  
Terminated with UK 4.8mm pin

## PMS 14-7016

Pack of 1  
Serrated dissecting forceps  
200mm + tip 2mm  
Terminated with UK 4.8mm pin

## PMS 14-7008

Pack of 1  
Serrated dissecting forceps  
240mm + tip 2mm  
Terminated with UK 4.8mm pin



+44 (0) 1453 752626



+44 (0) 1453 756750



sales@prima-medical.com



www.prima-medical.com



# Bipolar forceps

**100-025** 0.25mm tip

**100-045** 0.45mm tip

Pack 1

McPherson straight forceps 102mm



**102-025** 0.25mm tip

**102-045** 0.45mm tip

Pack 1

McPherson angled forceps 102mm



**110-025** 0.25mm tip

**110-060** 0.60mm tip

Pack 1

Jeweller 5 straight forceps 115mm



**112-025** 0.25mm tip

**112-060** 0.60mm tip

Pack 1

Jeweller 5 angled forceps 115mm



**115-025** 0.25mm tip

**115-060** 0.60mm tip

Pack 1

Jeweller 7 angled forceps 115mm







**190-050** 0.5mm tip  
**190-100** 1mm tip  
 Pack 1  
 Adson straight forceps 120mm



**120-030** 0.3mm tip  
**120-100** 1mm tip  
**120-200** 2mm tip  
 Pack 1  
 Straight forceps 150mm



**130-030** 0.3mm tip  
**130-100** 1mm tip  
**130-200** 2mm tip  
 Pack 1  
 Straight forceps 180mm



**140-030** 0.3mm tip  
**140-100** 1mm tip  
**140-200** 2mm tip  
 Pack 1  
 Straight forceps 200mm



**150-030** 0.3mm tip  
**150-100** 1mm tip  
**150-200** 2mm tip  
 Pack 1  
 Straight forceps 220mm

# Bipolar forceps

122-030 0.3mm tip

122-100 1mm tip

122-200 2mm tip  
Pack 1

Straight forceps – angled tip 150mm



132-030 0.3mm tip

132-100 1mm tip

132-200 2mm tip  
Pack 1

Straight forceps – angled tip 180mm



142-030 0.3mm tip

142-100 1mm tip

142-200 2mm tip  
Pack 1

Straight forceps – angled tip 200mm



152-030 0.3mm tip

152-100 1mm tip

152-200 2mm tip  
Pack 1

Straight forceps – angled tip 220mm





**160-030** 0.3mm tip  
**160-100** 1mm tip  
**160-200** 2mm tip  
 Pack 1  
 Bayonet forceps 165mm



**170-030** 0.3mm tip  
**170-100** 1mm tip  
**170-200** 2mm tip  
 Pack 1  
 Bayonet forceps 180mm



**180-030** 0.3mm tip  
**180-100** 1mm tip  
**180-200** 2mm tip  
 Pack 1  
 Bayonet forceps 200mm



**120-050IR** 0.5mm tip  
**120-100IR** 1mm tip  
**120-200IR** 2mm tip  
 Pack 1  
 Straight irrigation forceps 150mm



**160-050IR** 0.5mm tip  
**160-100IR** 1mm tip  
**160-200IR** 2mm tip  
 Pack 1  
 Bayonet irrigation forceps 165mm

# NonStick bipolar forceps

- Significant reduction of tissue adhesion to tips
- Reduced tissue trauma
- Easy to clean during use

The **NonStick** range of bipolar forceps offers significant advantages over standard forceps when used in soft tissue surgery.

The adhesion of "coagulated" tissue to the tips is substantially reduced due to the heat dispersion properties of the silver metal tipped forceps; silver is the best heat conducting material available and is the only material which is bio-compatible.

## How the NonStick forceps eliminate adhesion:-

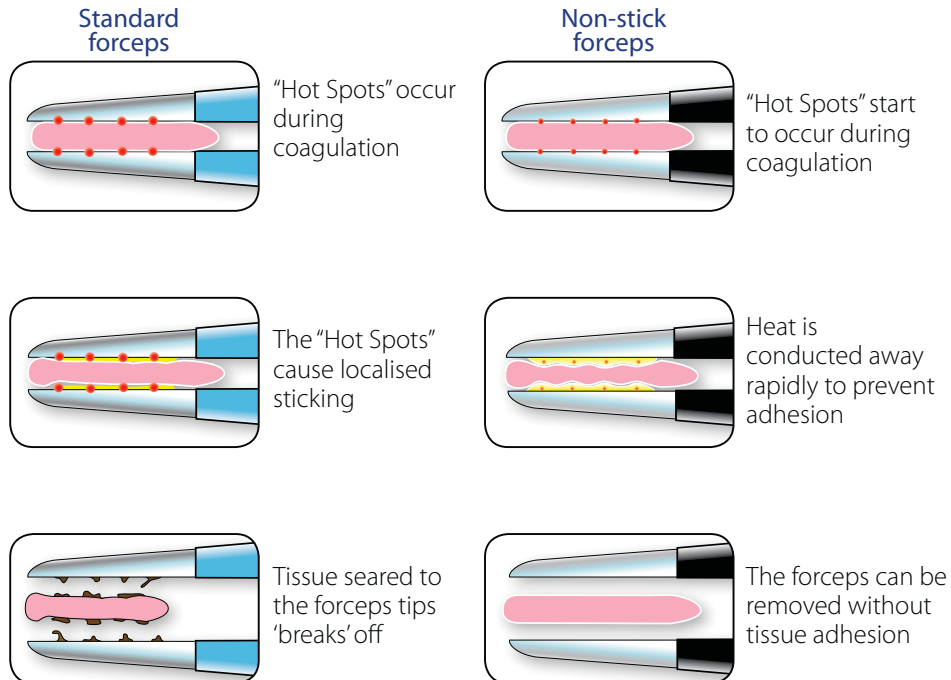

# NonStick



**120-030NS** 0.3mm tip  
**120-100NS** 1mm tip  
**120-200NS** 2mm tip  
Pack 1  
Straight forceps 150mm



**160-030NS** 0.3mm tip  
**160-100NS** 1mm tip  
**160-200NS** 2mm tip  
Pack 1  
Bayonet forceps 180mm



**180-030NS** 0.3mm tip  
**180-100NS** 1mm tip  
**180-200NS** 2mm tip  
Pack 1  
Bayonet forceps 200mm



**140-030NS** 0.3mm tip  
**140-100NS** 1mm tip  
**140-200NS** 2mm tip  
Pack 1  
Straight forceps 200mm



**142-030NS** 0.3mm tip  
**142-100NS** 1mm tip  
**142-200NS** 2mm tip  
Pack 1  
Straight forceps – angled tip 200mm







## Twin Footswitches

- Non-slip operation
- Robust
- Easy to clean
- Non - corrosive finish

## Connectors to generators

	Conmed / Aspen	FS250
	Bard / Davol	FS041
	Valleylab	FS206
	Erbe	FS720
	Eschmann 300 & 400 series	FS207
	Eschmann 800 series	FS307
	Unterminated footswitches without connectors	FS355F

All cables 5m long



- Ideal for use in sitting position
- Non-corrosive plastic finish



FS3250
FS3041
FS3206
FS3720
FS3207
FS3307
FS3355



+44 (0) 1453 752626



+44 (0) 1453 756750



sales@prima-medical.com



www.prima-medical.com



0120

## Single Footswitches

- Non-slip operation
- Robust
- Easy to clean



## Connectors to generators

		 Yellow (cut) single footswitch	 Blue (coag) single footswitch	 Black single footswitch	 White single footswitch
	Valleylab			FS210	FS211
	Erbe				FS501
	Birtcher			FS555	
	Eschmann 300 & 400 series	FS109	FS117	FS718	FS719
	Eschmann 800 series	FS209	FS217		
	Unterminated footswitches without connectors	FS355C	FS355D	FS355E	FS176

All cables 3m long (longer lengths available on request)



+44 (0) 1453 752626



+44 (0) 1453 756750



sales@prima-medical.com



www.prima-medical.com



# Pneumatically-operated Footswitch



Non-slip base



Fully secure cable

## FS2000

Footswitch for use with pneumatically operated generators

3 meter cable





## Prima Medical Limited

### Terms and conditions

All orders for the sale of goods are accepted by Prima Medical Limited on these terms and conditions, which supersede any previously published terms in a catalogue or elsewhere.

### Offers and acceptance

No obligation shall arise as a result of a catalogue entry, quotation or any other offer, until the company accepts the order from a customer, company or other organisation seeking to make a purchase.

### Orders

Where possible, please place orders by mail or fax. If obliged to order by phone, please ensure you have all the relevant details to hand in order to speed up this process. All orders will be processed only if made with full payment, except for such organisations and companies that have established account facilities with Prima Medical Limited. Orders will be processed for account holders only on provision of an Official Purchase Order, which has been duly signed.

### Prices

Prima Medical Limited reserves the right to alter prices at any time without prior notice. Prices charged will be as quoted when the order is received and accepted. If any prices have risen when an order is received, you will be contacted and invited to consider the new price, prior to processing your order. If the price has dropped, we will automatically process the sale at the new price.

## Satisfaction guarantee

It is our policy that if you are not totally satisfied with a product within 7 days of receipt, you may return the goods. We only ask that the goods must be unused, in an 'as new' condition. They must be in their original packaging and any included literature should be enclosed.

We reserve the right to apply a restocking charge of up to 25%. The guarantee does not apply to the sterile products, 'specials' or cut lengths of cable. No goods may be returned without a returns authorisation number, issued by our customer services helpline (+44 (0) 1453 752 626). Claims for goods damaged in transit must be made within 3 days of delivery. In the case of damaged items, always retain them for our representative or courier. None of these conditions affect your statutory rights.

## Back Orders

We reserve the right to ship part orders, or to hold orders until all items are available as required. We shall only levy one delivery charge. We reserve the right to cancel any part of an outstanding order should securing supply become untenable.

## Cancelling an Order

Orders can only be cancelled by prior agreement of Prima Medical Ltd. Where possible, and shipment from vendor or ourselves has not been made, we shall agree. Should a customer default on an order outside these terms we reserve the right to deduct the relevant costs of shipment and administration incurred by Prima Medical Ltd.

## Returns

No goods can be returned to the company without its express consent. In the event of faulty or damaged goods being received by the purchaser, please contact and advise us of the problem, whereupon arrangements to rectify the situation will be made. Claims for products shipped faulty or damaged must be made within 3 working days.

## Warranty

Prima Medical Ltd will, at its discretion, repair, replace or refund a product that develops a fault/s within the given guarantee period that is a result of faulty workmanship or design. In the unfortunate event of a fault arising, you should return the product to your nearest distributor for examination by the distributors' staff, or telephone the Order Line for advice. The warranty is void if any modification or attempted repair has been made to a product, or the product as been subjected to accidental damage. This warranty excludes any liability for consequential loss arising from defective products.

## Law

Any business transacted by Prima Medical Ltd is governed solely by English Law and none of the conditions stated affect your statutory rights.

SL005 05.12.09 © Prima Medical Ltd 2009

## We accept all major credit and debit cards



In the interest of security please telephone our sales department to pay by credit or debit card.

## Prima Medical Ltd

Unit 21  
Daniels Industrial Estate  
Bath Road  
Stroud  
Gloucestershire  
GL5 3TJ  
United Kingdom

+44 (0) 1453 752626

+44 (0) 1453 756750

[sales@prima-medical.com](mailto:sales@prima-medical.com)

[www.prima-medical.com](http://www.prima-medical.com)

Company names mentioned within this brochure are the property of their respective owners and are not to be taken as an endorsement of affiliation with Prima Medical Ltd. Specifications are subject to change without notice

All rights reserved. No part of this publication may be reproduced or transmitted in any form or by any other means, whether electronic or mechanical including by photocopy, recording or information storage and retrieval system, without permission in writing from the publisher. Authorisation to photocopy items for internal or personal use, or the internal or personal use of specific clients is granted by Prima Medical Ltd.

**All Products are Latex Free**  
Copyright © 2009, Prima Medical Ltd.



+44 (0) 1453 752626



+44 (0) 1453 756750



[sales@prima-medical.com](mailto:sales@prima-medical.com)



[www.prima-medical.com](http://www.prima-medical.com)



view our online catalogue at

[www.prima-medical.com](http://www.prima-medical.com)

Call today  
to receive your  
**FREE**  
Prima catalogue

