

FAMILY CLASSIC

OPEN – RAIN COVER – ENCASED TYPE



*“... okay, boys have
to be good
for something!”*

*Just
enjoy life!*

Lewens
MARKISEN



All good things come
from above –
with a valance.

Our FAMILY CLASSIC awning exudes proven Lewens quality, optimum user-friendliness and a summery appearance with its typical valance. The choice is yours: opt for the Open, Rain Cover or Encased type.

Options

For even greater comfort you can equip your FAMILY CLASSIC with:

▶ **Vario Valance**

The Vario Valance offers variable shade from the sun and privacy while retaining the headroom below the awning.

▶ **LEWENS-Matik**

An additional gear mechanism enables the pitch of the awning to be adjusted smoothly from 50 to 52 to adapt it to the position of the sun (can be supplied for up to 600 cm width maximum and 350 cm drop).

▶ **Support legs**

▶ **Lighting strip**

▶ **Patio heater**

▶ **Sun and wind sensor**

▶ **Radio remote control**

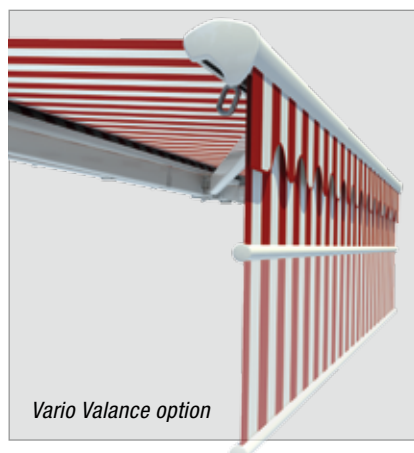

Vario Valance option

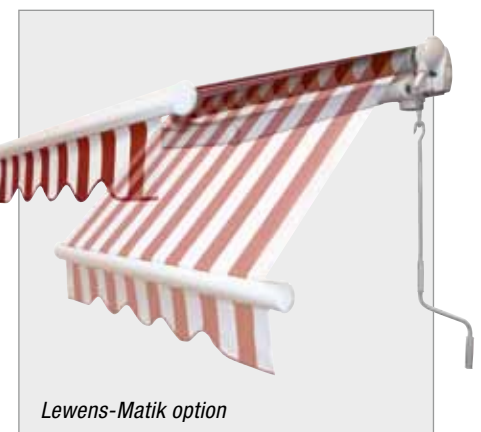

Lewens-Matik option



Support leg option



Lighting strip option

OPEN TYPE

On the basic FAMILY CLASSIC type, the awning fabric roller is exposed or “open”. Round end caps at the sides and the fabric cover shell on the front of the fabric roller give the awning a harmonious appearance.



SYSTEM

The FAMILY CLASSIC is a sturdy, long-lasting quality awning:

- ▶ Front profile with double hollow chamber and integral rain gutter
- ▶ 40 x 40 x 2 mm console tube, galvanised and powder-coated
- ▶ Rust-resistant pins, Teflon-coated bearings, high-grade steel screws



Family Classic – Rain Cover type

RAINCOVER TYPE

The **protective cover** on the FAMILY CLASSIC RAIN COVER type protects the awning when retracted against dust, rain and other effects of the weather.



In the central hinged arm joints, a plastic sheath prevents soiling and corrosion of the double cable and extends its service life.

ENCASED TYPE

Equipped with a **protective cover and back plate**, the ENCASED type of the FAMILY CLASSIC provides secure all-round protection for the fabric roller.

The side caps are of the same design as for the Rain Cover type.



Arm bracket of high-strength aluminium alloy matched to the contours of the fabric cover shell, upper arm fork of forged aluminium.

SYSTEM

Technical features

TYPE	OPEN – RAIN COVER - ENCASED
Width 1 unit	max. 700 cm
Width 2 units	max. 1.300 cm (linked system)
Width 3 units	max. 1.950 cm (linked system)
Linked systems (from 701 cm system width) with slit cover	
Drops (possible arm lengths)	150 / 200 / 250 / 300 / 350 / 400 cm Special arm lengths possible (extra charge)

Centimetre-accurate manufacture in all intermediate widths!

Drive	Motor drive (electric motor) , crank drive (bevel gear) possible on request (reduced price)
Scope of supply, attachment	– incl. wall consoles for concrete B25 C20/25 (for anchor bolts: FAZ II M12)
Framework colours	– 16 RAL colours and 5 textured finishes to choose from (see LEWENS price list for colour chart) – Natural silver: E6/EV 1 anodized; small components silver RAL 9006 (reduced price) – Special RAL (extra charge) – Special colours and effect coatings on request
Awning fabrics	– From our LEWENS collection – Branded acrylic , spun-dyed, ultra fade resistant – Quality sewing yarn
Valance	– Supplied as standard with valance – Standard height 20 cm
Accessories**	<ol style="list-style-type: none"> Sun and wind sensor Radio remote control/electric motor with integral radio control Vario Valance (not with 4. and 6.) – for systems up to 600 x 350 cm – in 150 and 200 cm height (Vario Valance in 200 cm valance height can only be supplied with gear) LEWENS-Matik (not with 3., 5. and 6.) – up to max. 600 cm width and 350 cm drop – not in combination with Vario Valance Lighting strip (not with 4. and 6.) Patio heater (not with 3., 4. and 5.) Support legs

** = Combination options and restrictions can be found in the current Lewens price list.

Certification

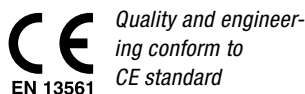

Warranties

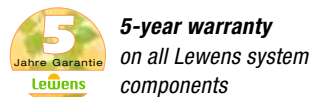

L.UST FOR LIFE
I.NTELLIGENCE
F.REEDOM
E.ASY LIVING

Fitting

OPEN Type

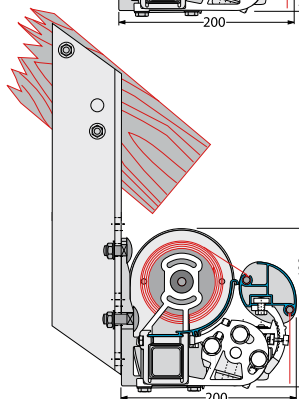
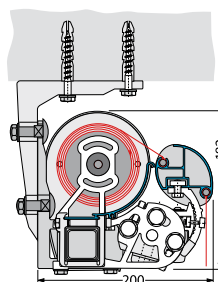
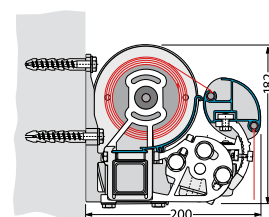

RAIN COVER Type (see fig.)/ ENCASED Type

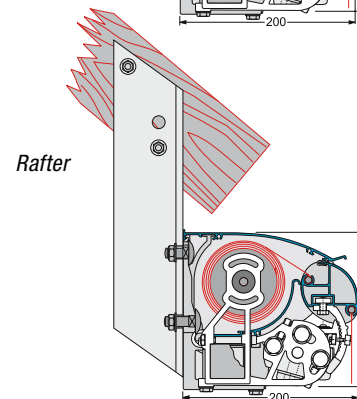
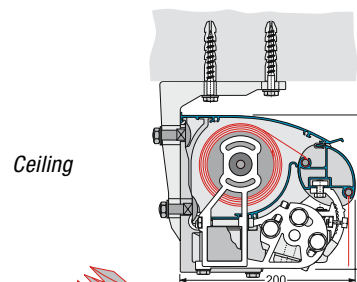
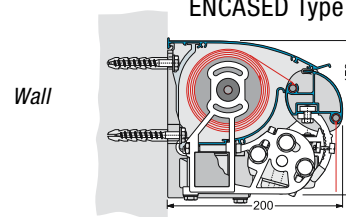

Lewens
MARKISEN

Your stockist will be happy to advise you:

Just
enjoy life!

www.lewens-markisen.de