

Verderflex VF40

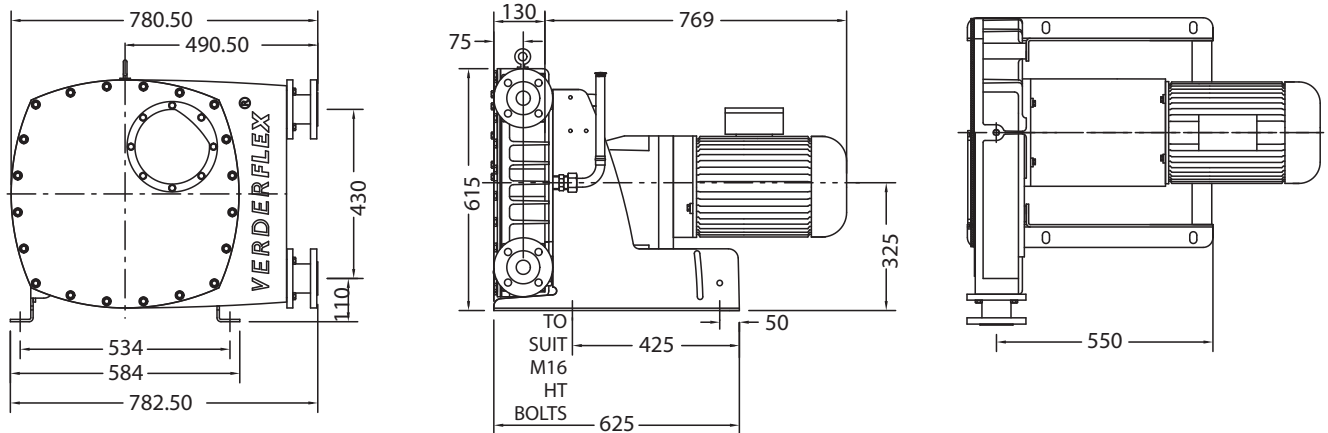

VERDERFLEX®

Description	Material	Paint Detail
Pump Housing	Cast Iron (GG25)	Green Powder Coated
Front Cover	Carbon Steel with Perspex Inspection Window	Powder Coated
Rotor	Cast Iron (GG25)	
Rotor Shoes	Aluminium (6082T6)	
Port Flange	304 Stainless Steel Universal slotted design fits with DIN PN16, ANSI 150# & JIS10K Hygienic Flanges available on request to special order	
Inserts	Stainless Steel (316L) Options: Polypropylene, P.V.D.F. Inserts	
Mounting Frame	Carbon Steel	Powder Coated
Lubricant	Verderlube - Glycerine based compound Verdersil - Silicone oil	
Hose	Natural Rubber (NR) Options: Nitrile Buna Rubber (NBR) Ethylene Propylene Diene Monomer (EPDM), Food Grade Nitrile Buna (NBRF) and Hypalon® (CSM)	
Typical Pump Unit Weight	273 - 295 kg	



All dimensions are in mm.
All dimensions and weights are for guidance only.



Verderflex VF40

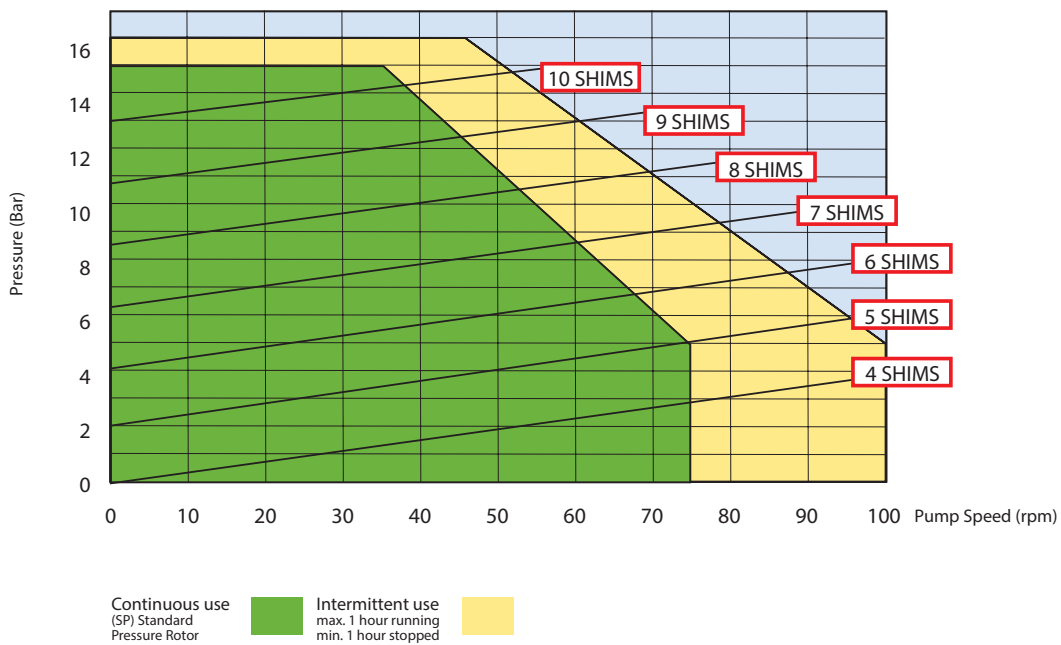
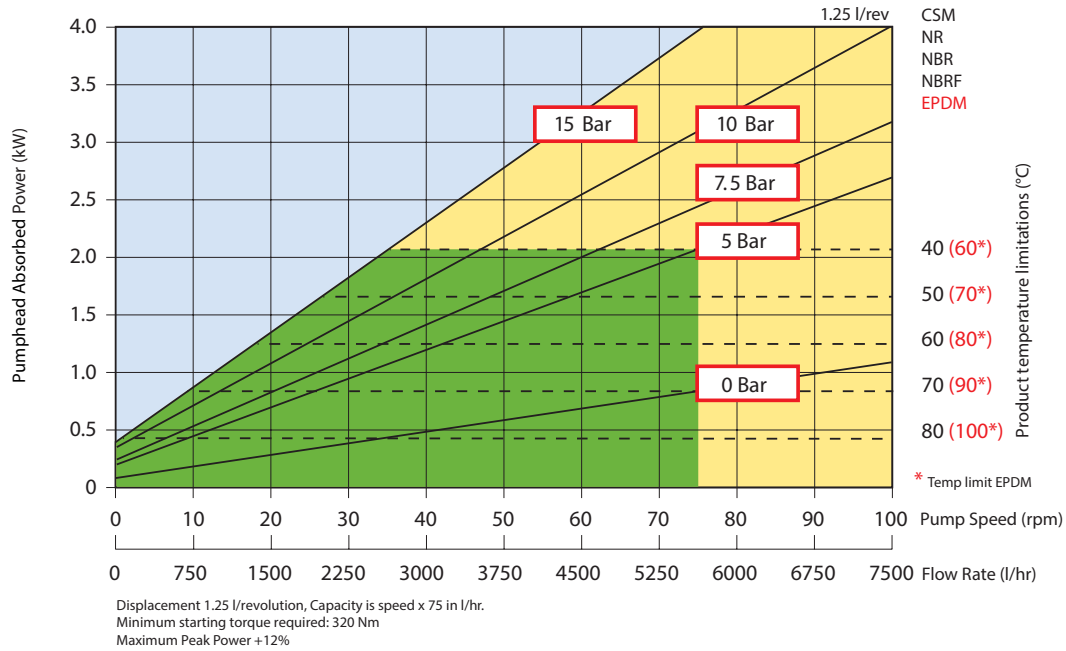
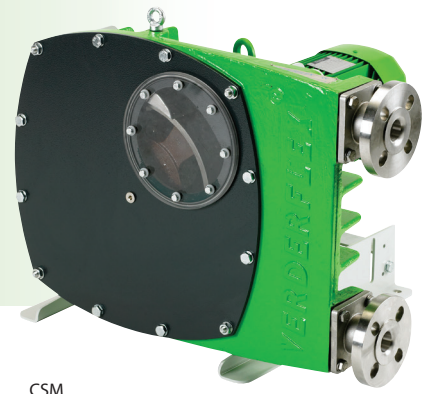

Flows are typical and were measured with water at 20°C with no suction lift or discharge pressure. Actual flows will vary according to suction conditions, discharge pressure and normal component production tolerances.

VF_Techno_Rev02_2013_(eu)_VF

**Find your local supplier
at www.verderflex.com**

For construction installation and floor mounting drawings
please contact your local authorised Verderflex® distributor.

VERDER
passion for pumps