

The Intelligent Choice in Comfort

## FUJITSU GENERAL LIMITED

1116, Suenaga, Takatsu-ku, Kawasaki 213-8502, Japan  
<http://www.fujitsu-general.com/>



ISO 9001 Certified number: 01 100 89394  
 ISO 14001 Certified number: 01 104 924501  
 Fujitsu General (Thailand) Co., Ltd.



ISO 9001 Certified number: 01 100 79269  
 ISO 14001 Certified number: 310102-UK  
 Fujitsu General (Shanghai) Co., Ltd.



ISO 9001 Certified number: 00608Q1061R2M  
 ISO 14001 Certified number: 00608E20454R2M  
 Fujitsu General Central Air-conditioner (Wuxi) Co., Ltd.

### Notice for specifications

I.U.=Indoor Unit O.U.=Outdoor Unit Qu=Quiet \* =Not decided yet

- Specifications and design are subject to change without notice for future improvement.
- For further details, please check with our authorised dealer.
- Cooling / Heating capacities are based on the following conditions.

- Performance test is in accordance with EN14511
- Seasonal efficiency test is on accordance with EN14825
- Sound power test is in accordance with ENV12102

Cooling	Indoor temp. : 27°C DB / 19°C WB	Heating	Indoor temp. : 20°C DB / 15°C WB
	Outdoor temp.: 35°C DB / 24°C WB		Outdoor temp.: 7°C DB / 6°C WB

- "AIRSTAGE"™ and "WATERSTAGE"™ are worldwide trademarks of FUJITSU GENERAL LIMITED and are registered trademarks in Japan and other countries or regions.
- "nocria"™ is a worldwide trademark of FUJITSU GENERAL LIMITED.
- iPhone and iPad are trademarks of Apple Inc., registered in the U.S. and other countries.
- Other company and product names mentioned herein may be registered trademarks, trademarks or trade names of their respective owners.

• Actual products' colors may be different from the colors shown in this printed material.

Distributed by :

# PRODUCT CATALOGUE 2014

SPLIT / MULTI SPLIT / VRF / VENTILATION / AIR TO WATER

# Creation of Comfort

Fujitsu General creates high-quality and environmentally-friendly products that provide good comfort in accordance with our basic policy to a "create comfortable environment" by utilizing the air conditioning technology and creativity we have fostered over many years.

## 12 Overseas Sales Companies and 7 Overseas Manufacturing Companies

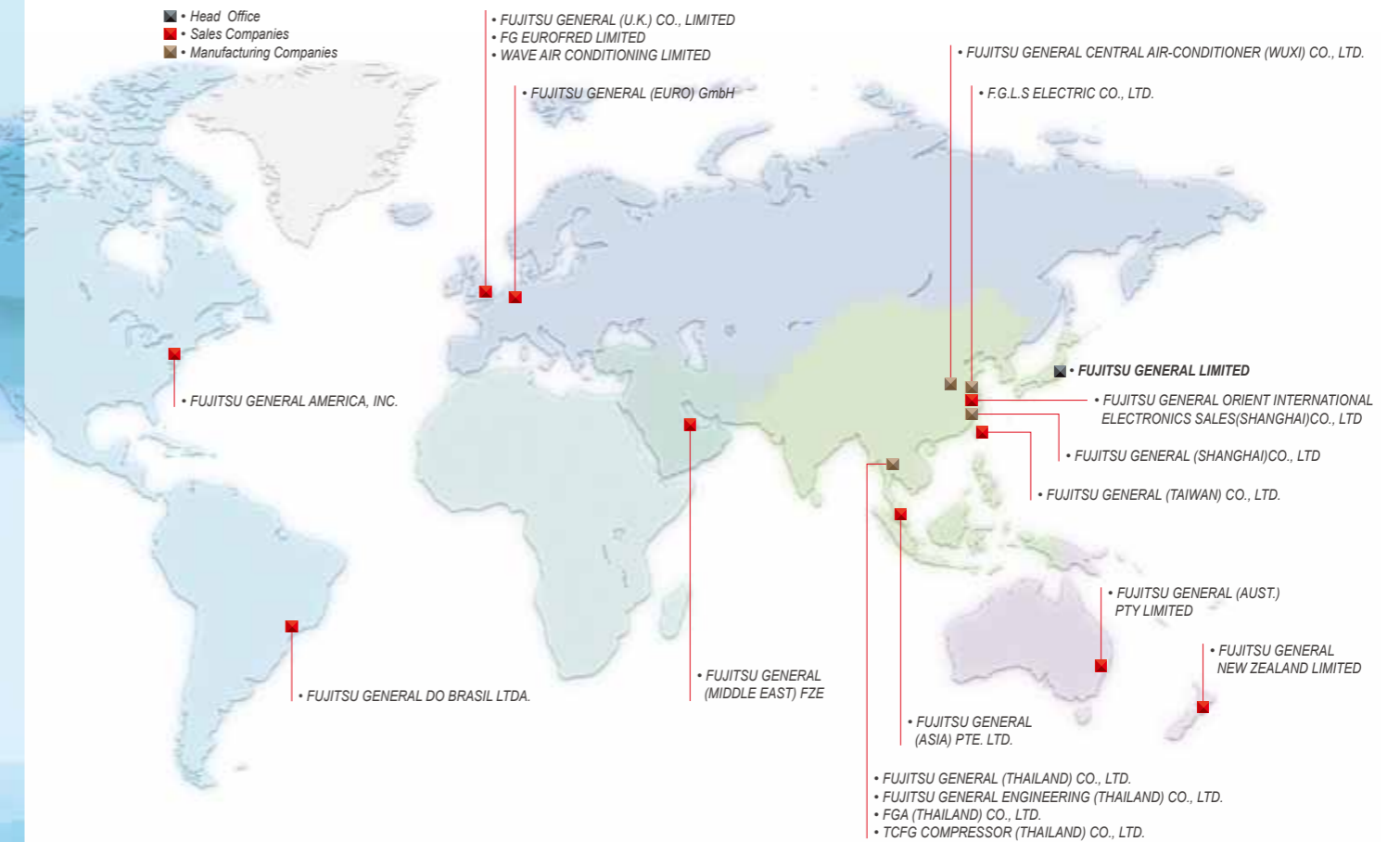

## High Quality Development & Production Environment

JAPAN Head Office  
R&D Center And 60m Height Difference Testing Tower



Fujitsu General (Shanghai) Co., Ltd.



F.G.L.S. Electric Co., Ltd.



Fujitsu General Central Air-conditioner (Wuxi) Co., Ltd.









FGA (Thailand) Co., Ltd.

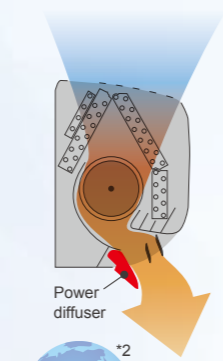

Fujitsu General (Thailand) Co., Ltd.  
Fujitsu General Engineering (Thailand) Co., Ltd.  
TCFG Compressor (Thailand) Co.,Ltd.

# Our History Since 1936

Overseas Air Conditioning Business since 1971

<p><b>1936:</b> Established as Yaou Shouten Ltd.</p> <p><b>1960:</b> Air conditioning business start. Japan-domestic business start.</p> <p><b>1971:</b> Air conditioner exports to Middle East.</p> <p><b>1977:</b> "Super Power, Super Quiet" series</p>	<p><b>1982:</b> Window type 3 Super series <b>AL/AX series</b></p> <p><b>1985:</b> Large wall mounted and multi air conditioner introduced.</p> <p><b>1991:</b> Air conditioner with the world's first lambda heat exchanger</p> 	<p><b>1995:</b> Air conditioner with the world's first power diffuser</p>  <p>Power diffuser</p> 	<p><b>2001:</b> VRF air conditioners</p>  <p><b>2003:</b> Air conditioner with the world's first automatic self-cleaning filter system</p>  <p><b>World's First</b></p>	<p><b>2009:</b> VRF combination type</p>  <p><b>AIRSTAGE V-II</b></p> <p>Air to Water system</p>  <p><b>WATERSTAGE</b></p>	<p><b>2011:</b> Hi-spec Design model</p>  <p><b>LT LU Series</b></p> <p>Small VRF series</p>  <p><b>AIRSTAGE J-II</b></p>	<p><b>2012:</b> VRF Heat Recovery type</p>  <p><b>AIRSTAGE VR-II</b></p>	<p><b>2014:</b> Small VRF series</p>  <p><b>AIRSTAGE J-IIS</b></p>	
1936	1980	1990	2000	2005	2010	2011	2012	2014

Company Establishment

Manufacturing Company Establishment

Sales Company Establishment

**1976:**  
North America sales company.

**1977:**  
Europe sales company (UK).

**1978:**  
Australia sales company  
Europe sales company (Germany).

**1980:**  
Brazil sales company

**1997:**  
Asia sales company (Singapore).

**1998:**  
Middle East sales company (UAE)  
New Zealand sales company

**2002:**  
Taiwan sales company

**2006:**  
China sales company

**1991:**  
Air conditioner manufacturing company in Thailand.

**1994:**  
Air conditioner manufacturing company in Shanghai, China.

**1998:**  
Air conditioner motor manufacturing company in Thailand.

**2006:**  
VRF air conditioner manufacturer, sale, and service company in China.

**2007:**  
Air conditioner technology building completed on Main Office group.

**2009:**  
Operation of compressor factory begins in Thailand.



**2012:**  
Joint venture with Toshiba Carrier Corporation.

\*1. Announced 1991. In room air conditioner for the home (our company's investigation)  
\*2. Announced 1994. In room air conditioner for the home (our company's investigation)  
\*3. Announced 2002. In room air conditioner for the home (our company's investigation)

## Advanced Research Facility and Equipment

### Performance Testing



### Transportation & Handling

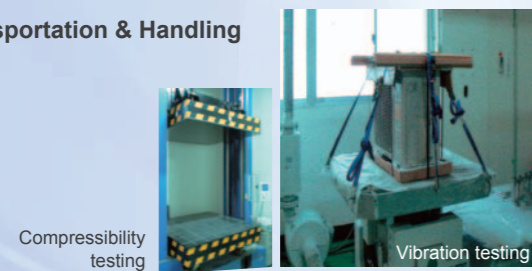

### Reliability Testing



## Testing Laboratory

### Fujitsu General EMC Laboratory Limited

International test site for EMC regulation

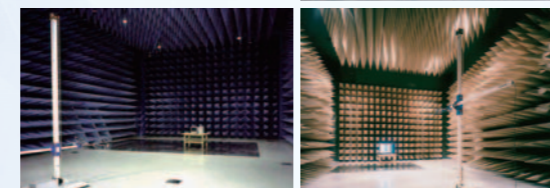

### 60-m High Difference Testing Tower

Objective is to confirm oil circulation of compressor for reliability



## High Quality Assurance

Product quality assurance

All Fujitsu General factories have acquired ISO 9001, and have built a quality control system common around the world. High quality products are offered to all over the world based on stringent quality inspections.

### Receiving inspection

Parts procurement requires a supplier's test report. European regulation RoHS inspection is also performed by special test department in-house. Total number inspection is performed especially on main parts to remove defectives.

### Stringent product quality inspection

Stringent quality inspection is carried out at all production processes. High quality is maintained by stringent checks by inspectors and repetitive inspection.

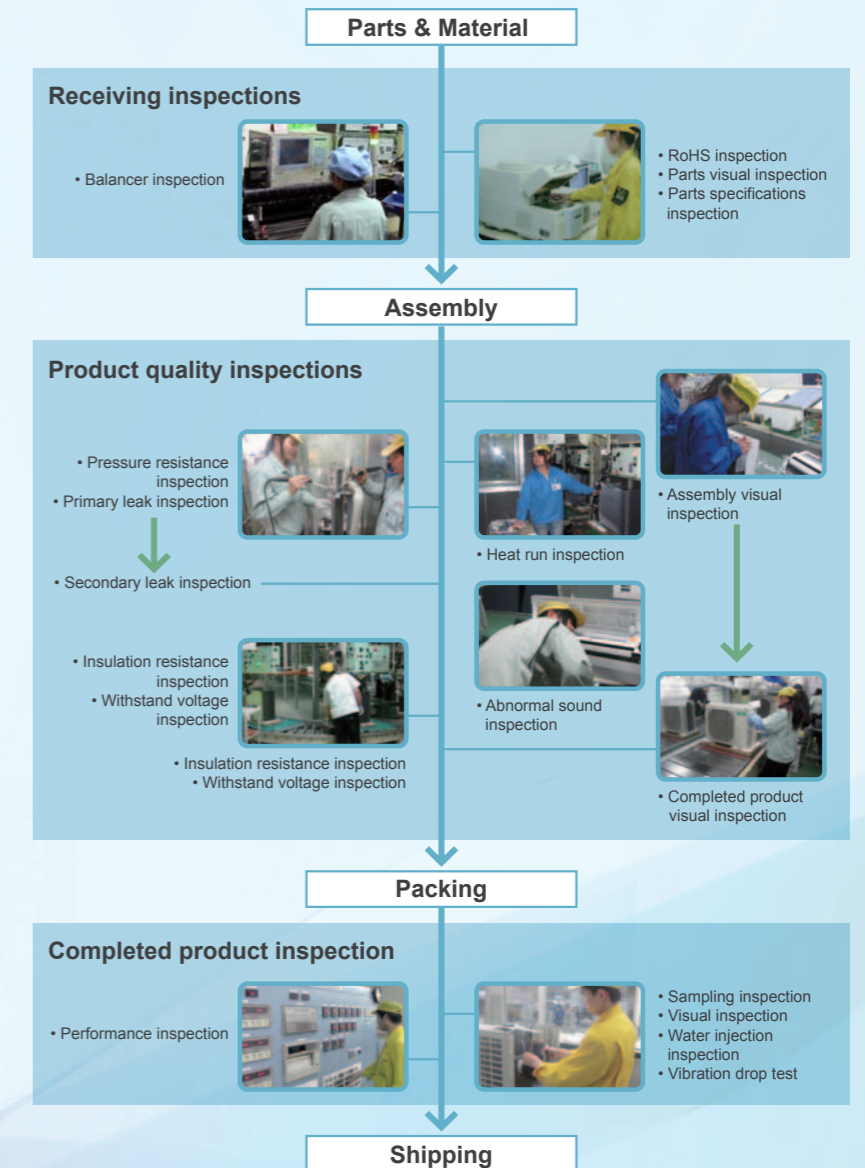

## R & D Center



## Acquisition of ISO 9001 and ISO 14001

Each of overseas production bases (5 companies) has completed the acquisition of ISO 9001 and ISO 14001 individually.

In 2012, overseas sales bases (11 companies) acquired the certification of ISO 14001.

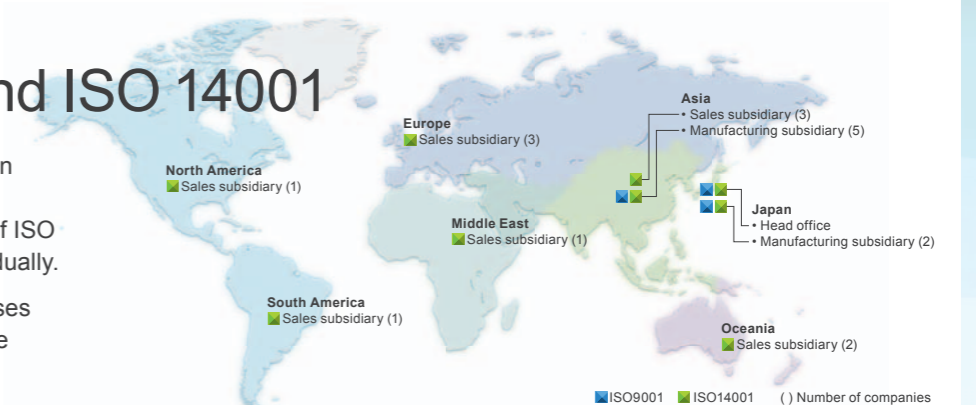

# GLOBAL BUSINESS ACTIVITIES

We are engaging in advertising, human resource development, CS activities, and social contribution activities worldwide. These activities have been recognized throughout different regions by the awards we have been honored with.



## Europe



HVAC trade show in Europe countries



HVAC trade show in Europe countries



Presentation & training

International authoritative design awards



The iF Product Design Award is given each year by "iF International Forum Design GmbH" for industrial products from around the world.



The product design competition has existed since 1955. Its award, the "red dot", is an internationally recognised quality seal.

## America



Training (Brazil)



Billboard (Montreal)



Call center



Distributor meeting



HVAC trade show in Brasil (FEBRAVA)

## Middle East



Billboard at airport



Distributor meeting (Dubai)



Training for dealers (Middle East)

## Oceania



Charity (Christchurch)



Training for installer



HVAC trade show in Australia



GfK retail No.1 products in 5 years

## Asia



Billboard (Tianjin)



Factory tour for primary school



Billboard (Hong Kong)



Distributor meeting



SE training



Presentation for sales companies (Myanmar)



"Dealer Design Awards" of "the NEWS"

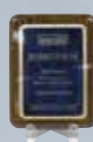

Gold Award (Category: HVAC & PLUMBING) in Reader's Choice Awards



Coolworld Industry Awards "Most Efficient Air Conditioner"



Canstar Blue Most Satisfied Customers Award



China State Construction Engineering Luban Prize



The Good Design Award is sponsored by the Japan Institute of Design Promotion and is awarded once a year for an item of excellent design.

# High Efficiency

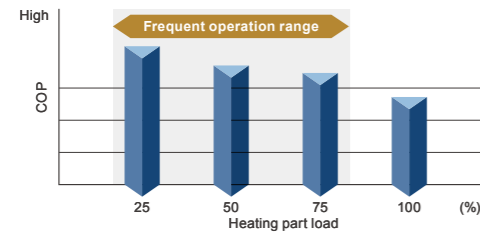

## Pursuit of Seasonal Efficiency

Over 90% of actual operation time, air conditioners are operated at partial capacity instead of rated capacity. We focused on high seasonal efficiency by all DC inverter control and high efficiency technology.



Wide high efficiency range  
DC twin rotary compressor

## All DC Inverter Technology

### DC twin rotary compressor

The high efficiency DC inverter type "2-cylinder rotary compressor" is used for our product ranges. It has achieved higher energy efficiency compared with similar compressors by optimizing the structure inside the compressor.

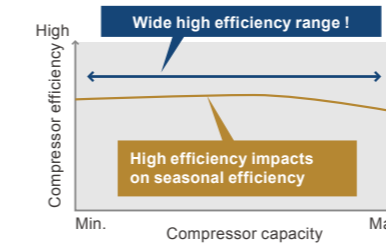

### DC fan motor

DC fan motor produces high power, wide operation range, and high efficiency.



### Sine-wave DC inverter control

High efficiency operation is realized by using a sine wave DC inverter control.

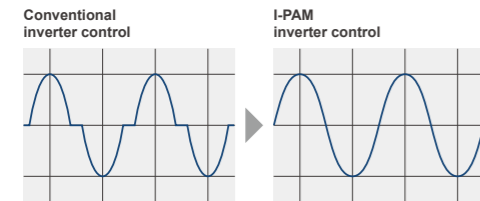
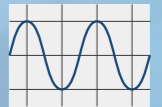

## Optimized Inverter Control

### I-PAM (IPM\* + PAM) inverter control

I-PAM inverter control is a technology which reduces loss by adjusting the current waveform to a better sine waveform. This promotes the effective use of the input power supply to attain high performance.

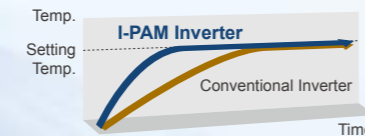

In addition, the voltage is raised at the start of operation and fast comfort is attainable by more powerful operation.  
IPM\*: Intelligent Power Module

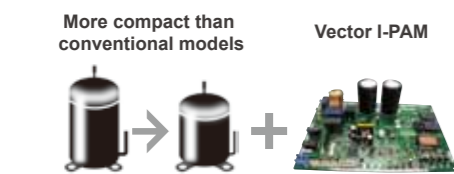

It becomes more powerful with the newly developed high efficient compressor motor control.

### V-PAM (Vector + I-PAM) inverter control

V-PAM inverter control reduces the effects of magnetic flux and increases the maximum speed and efficiency of the compressor by vector control technology. With this technology, further miniaturization, higher efficiency, and better performance are attained.

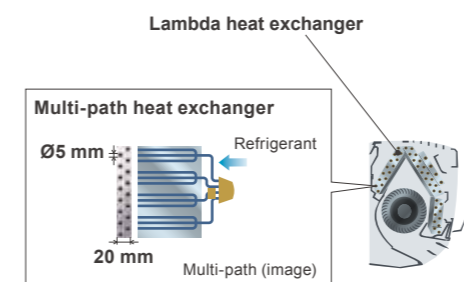

## High Efficiency Heat Exchanger

### High density multi-path heat exchanger

Heat exchange performance is substantially improved by thin and high-density heat exchanger and multi-path efficiency technology.

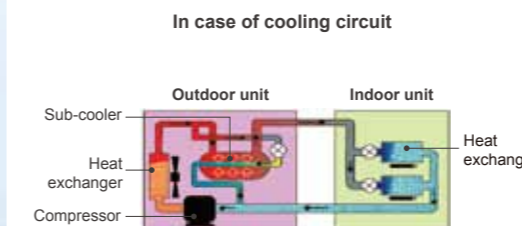

### High performance sub-cool heat exchanger

Higher performance achieved by mounting of counter type bypass circuit. (Large multi type, VRF)

# Energy Saving Control

## Smart Operation

### Human motion sensor control

Human motion sensor catches movements of people in a room, and operates with lower capacity when people leave the room. When people come back to the room, it automatically returns to the previous operating mode.

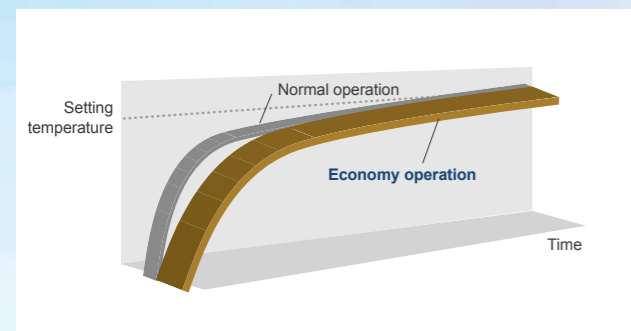
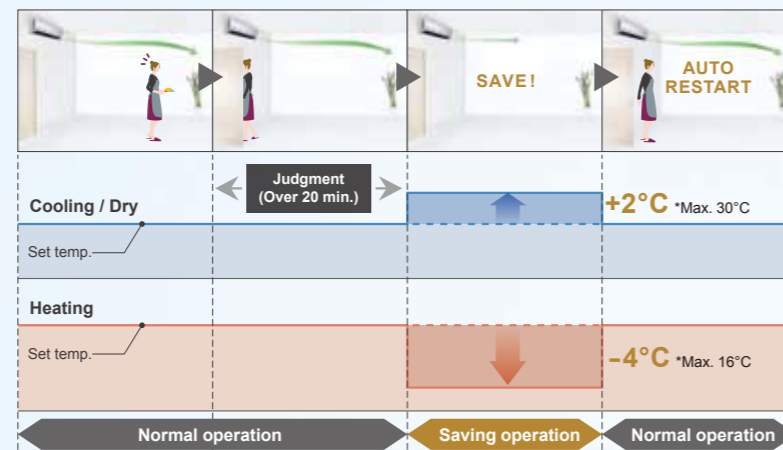
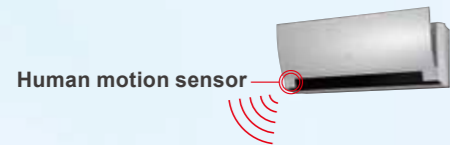

### Economy operation

Limits the maximum operation current, and the power consumption is cut down and the maximum load is suppressed.

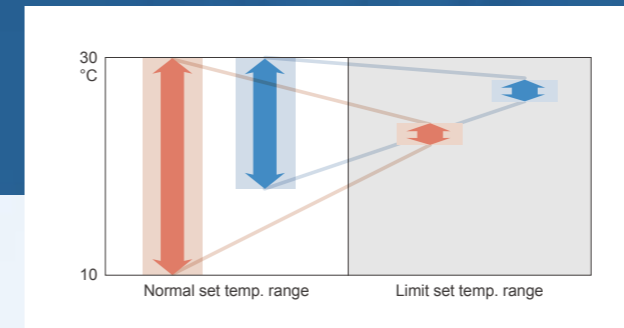

### Room temperature set point limitation

The minimum and maximum temperature range can be set giving further energy saving while considering the comfort of the occupants.

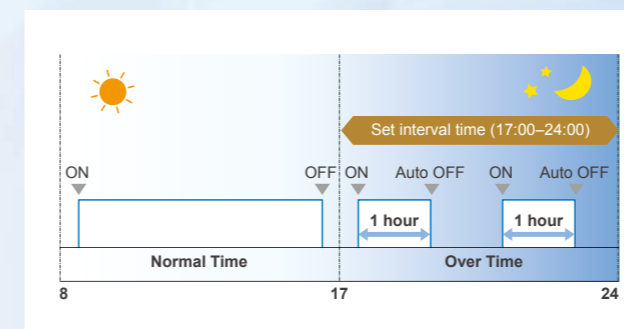

### Auto-off timer

- The indoor unit is turned off automatically when it reaches to the preset operating time frame.
- The time frame of the "Auto off timer" can be flexibly scheduled.
- Off time can be set from 30 to 240 minutes.



Example: At interval time hour (17:00-24:00) to prevent forgetting to turn off  
Set off time : 1 hour

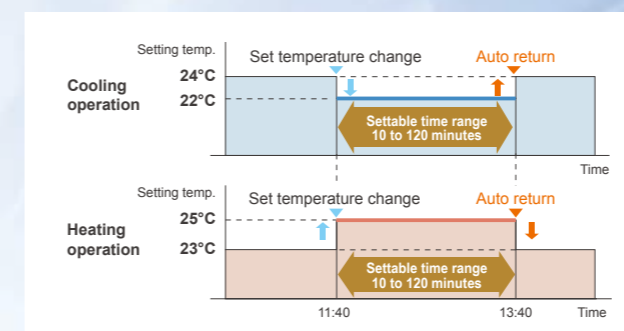

### Set temperature auto return

- The setting temperature automatically returns to the previous setting temperature.
- The time range in which the set temperature can be changed is 10 to 120 minutes.

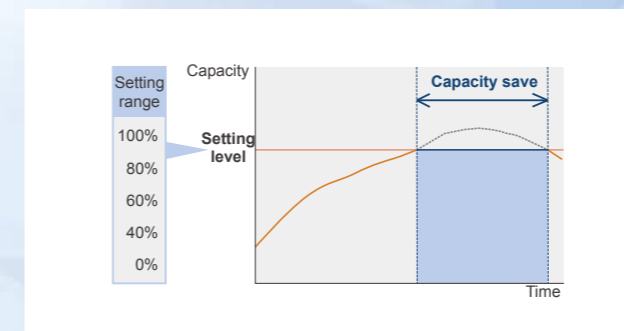

### Capacity save operation

Operation capacity can be set in 5 steps for rated capability. The power consumption at peak is cut down and the maximum load is suppressed.

# Comfort Performance

## Quick Comfort

### Comfort airflow

Precision wind direction control is realized and ventilation efficiency is also improved by 3 technologies. Our airflow control makes your environment more comfortable.

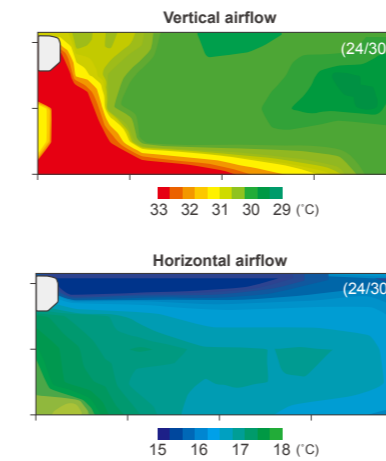

## Powerful Heating

High heating capacity is realized even at low outdoor temperature by mounting a large heat exchanger or large DC rotary compressor and developing high performance inverter PCB

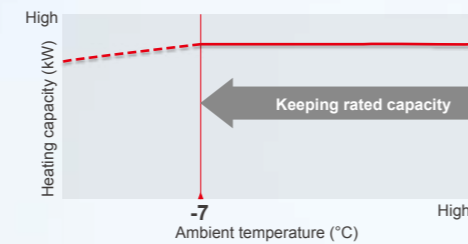

## Powerful operation

Continuous operation by maximum airflow and maximum compressor speed after a certain period of time allows the temperature to reach the setting temp. quickly.

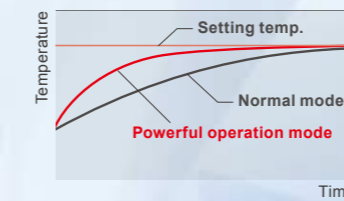

## 10°C Heat operation

When you leave, minimum heating operation is performed to maintain the room temperature. (Maintained at 10°C)

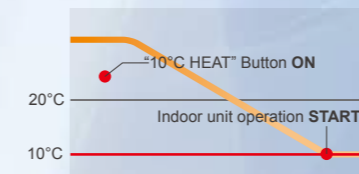

## Quiet and Comfort Control

### Outdoor unit low noise operation

Users can choose low noise levels, depending on the installation environment. The operation time can be set using the timer.

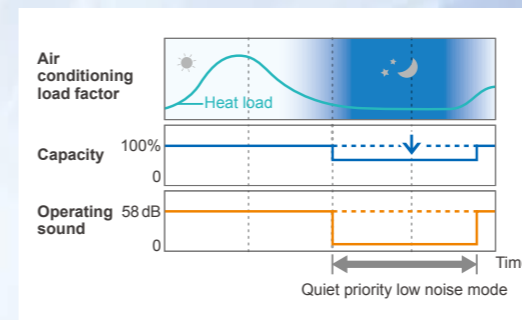

### Auto changeover function

At Auto setting, the cooling / heating mode is automatically switched according to the set temperature and room temperature.

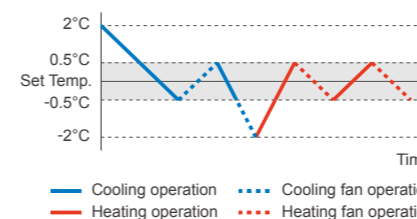

### High density heat exchanger

High-density 5-mm thin tube diameter heat exchanger mounted. Capacity is enlarged including sub heat exchanger. Heat exchange efficiency substantially improved.

#### Sub heat exchanger

Heat exchanger volume About **35% UP!** comparing previous model

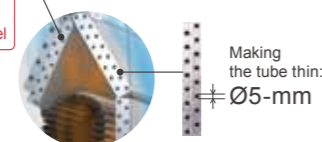

### All DC inverter technology

By All DC inverter control, electricity loss is decreased and power consumption is substantially reduced.

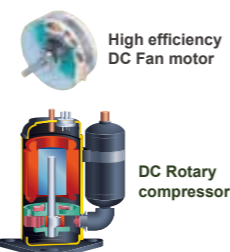



# Smart Design

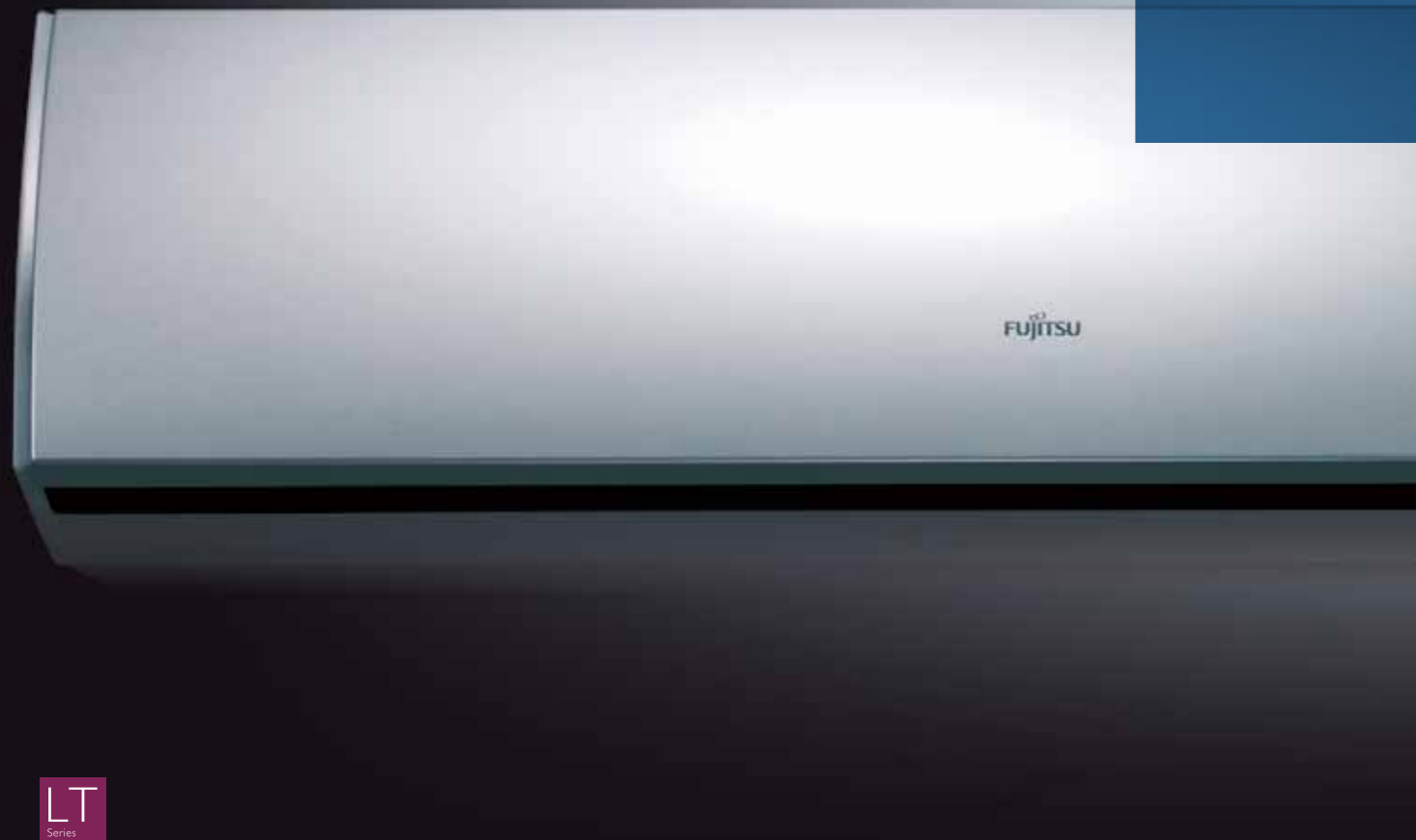

Pursuit of advanced design achieving both functionality and beauty.



red dot design award winner 2012



The stylish design of this simple flat panel looks thin and compact from all directions.



## Creating Harmony and New Interior Design Space in a Variety of Installation Environments

Thinness and simplicity was thoroughly pursued in this design to fit the interior design. The lambda shaped high-density multi-path heat exchanger construction and full cover slide open panel provide both beauty and functionality. The remote controller has also been designed utilizing ergonomics for ease of use while also pursuing beauty even in the details. Fujitsu General provides its customers with highly functional air conditioners designed with high artistic sensitivity



Wall Mounted

**High Spec. & Design :** ASYG09LTCA / ASYG12LTCA

**High COP :** ASYG07LUCA / ASYG09LUCA / ASYG12LUCA / ASYG14LUCA

**Standard :** ASYG07LMCA / ASYG09LMCA / ASYG12LMCA / ASYG14LMCA

**Basic :** ASYG07LLCC/ASYG09LLCC/ASYG12LLCC

# Easy-To-Use Control

## Residential use



Easy air conditioner control from inside or outside the house using the Smartphones, Tablets, and PC

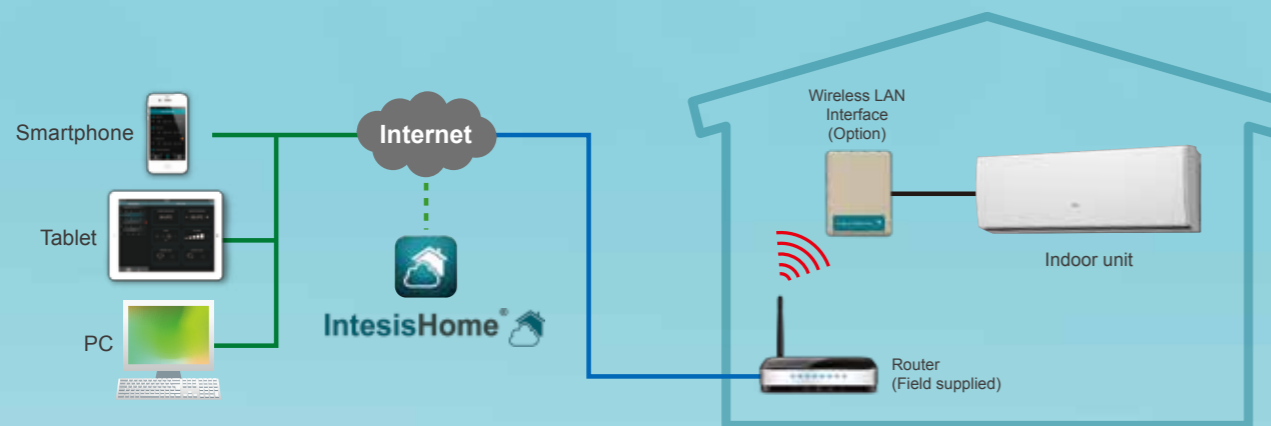

Fujitsu General provides various easy-to-use Controllers

Fujitsu General is using ergonomics to expand the use of easy-to-use designs such as easy-to-read large LCD panels, easy-to-operate buttons, and displays with easily recognizable icons.

The individual controllers match the user operational environments, and the home controller makes batch energy saving management easy. Ease of use was pursued using simple operation buttons, a large LCD screen, and other features.



**NEW**



It is the most advanced solution to remotely manage an Air Conditioning system using all sort of mobile devices such as Smartphones, Tablets, and PC.

Fujitsu General provides an interface that supports central management systems such as KNX®, MODBUS®, BACnet®, and LONWORKS®.

This allows customers to easily perform central control and monitoring of air conditioning equipment.



### Home central control



Central Remote Controller

### Simple individual control



Wired Remote Controller

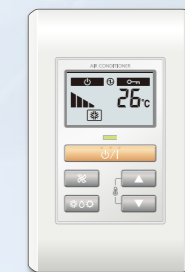

Simple Remote Controller



Slim Wireless Remote Controller

# Easy-To-Use Control

## Commercial use

### Fujitsu General provides various easy-to-use Controllers

Fujitsu General is using ergonomics to expand the use of easy-to-use designs such as easy-to-read large LCD panels, easy-to-operate buttons, and displays with easily recognizable colors and icons.

We offer a wide range of central control equipment to meet the building air conditioning scope and application. Great care was taken to achieve a visually intuitive design and one-touch operation.



#### Individual & Simple central control

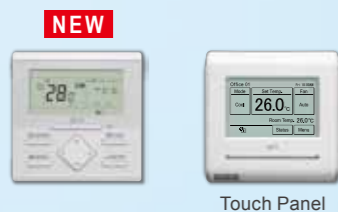

Touch Panel

Wired Remote Controller

#### Each floor or Small building management control



Touch Panel Controller

#### Large building management control

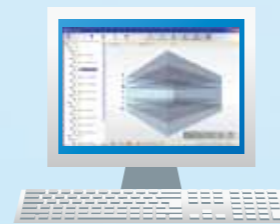

System Controller

Software

### Easy air conditioner control in the office using the Smartphones, Tablets, and PC

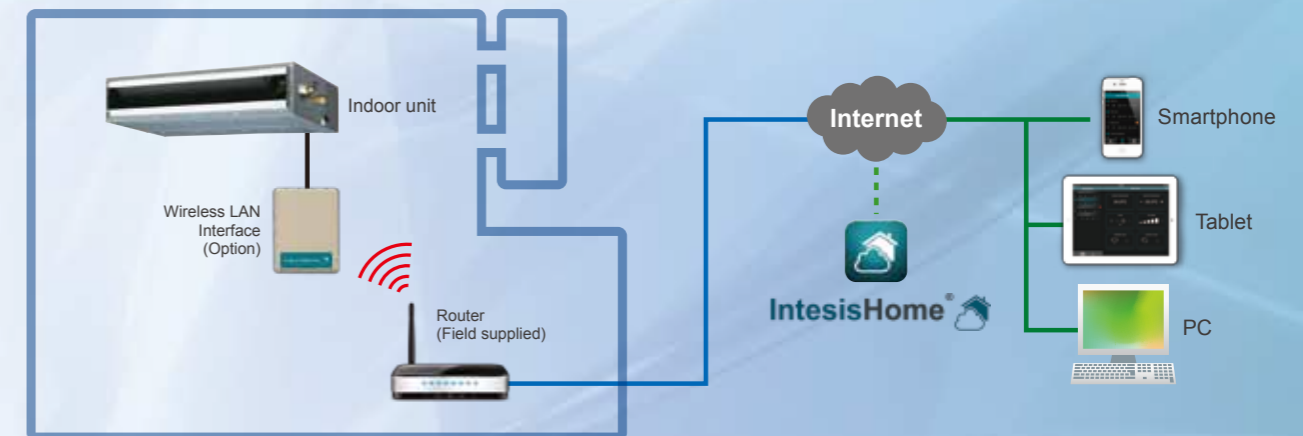

It is the most advanced solution to remotely manage an Air Conditioning system using all sort of mobile devices such as Smartphones, Tablets, and PC.

Fujitsu General provides an interface that supports central management systems such as KNX®, MODBUS®, BACnet®, and LONWORKS®.

This allows customers to easily perform central control and monitoring of air conditioning equipment.



Fujitsu General provides a variety of product and technical information to engineers and consultants, and also conducts new product research and design support activities. We provide a wide range of support to maintain high quality from design to installation.

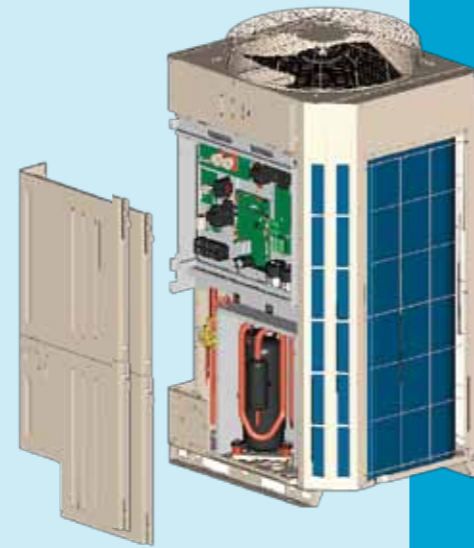

**Technical information**

We provide information and tools that are useful for air conditioning system design, such as unit performance data and tools that make model selection and estimation easy.

**Features**

- Design & Technical Manual
- Model Selection & Estimation
- Certificate Data
- 2D / 3D CAD Data

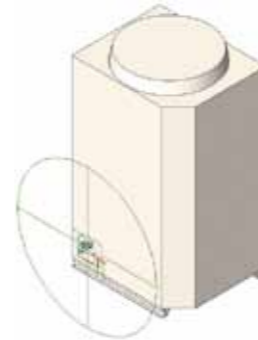

Training for installer

**Training**

Fujitsu General has 7 training facilities around the world that regularly conduct specialized product, technical, and service training. These research facilities also support the development of people with high technical capability.

**Features**

- Designing AIRSTAGE™ Systems
- Control System on-site training



Presentation & training for dealers 2



**Product information**

New product information is provided in the form of documents and movies for every new model released. These can be downloaded from a private section of our website. To access this website, please contact your Fujitsu representative.

**Features**

- Product News
- Brochures & All Manuals
- Feature Promotion Movie

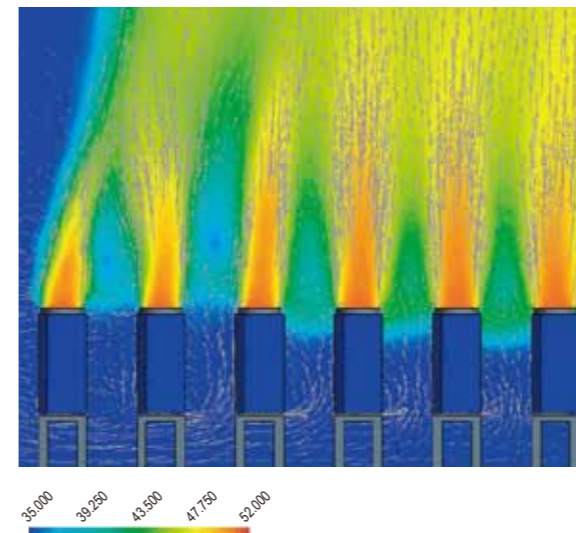

**Technical support**

Technical support is provided at every stage from design to installation to assist in providing the most suitable air conditioning solution.

**Features**

- CFD Simulation
- Guide line
- Commissioning Support



## Design Simulator

Put the charts and pens away and design your projects on your computer with ease using the Design Simulator. Everything from selecting indoor and outdoor units, allocating controls and optional parts to designing the piping and wiring systems is made easier using the program's built-in features. Once your project is designed take advantage of the Export functions to easily get materials lists, product specifications, refrigerant calculations and more - it'll even export to Word or Excel formats, and group the relevant CAD data for your project.



## Building Information Modeling (BIM)

FUJITSU GENENRAL provides the Building Information Modeling (BIM) object models and contents for our VRF system and some products to the architect, designer and contractor using Autodesk® Revit® technology from our Website and Autodesk® Seek Website, etc.

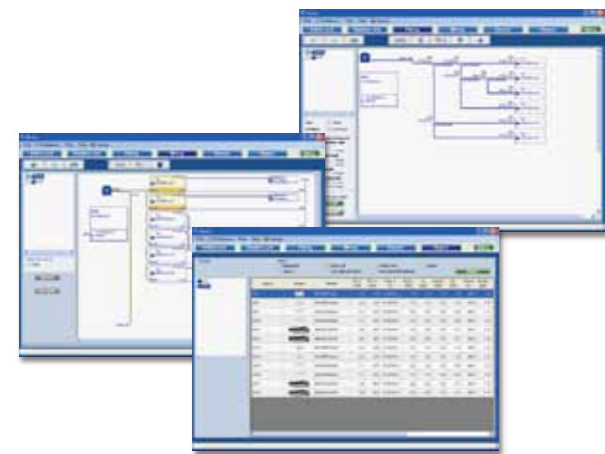
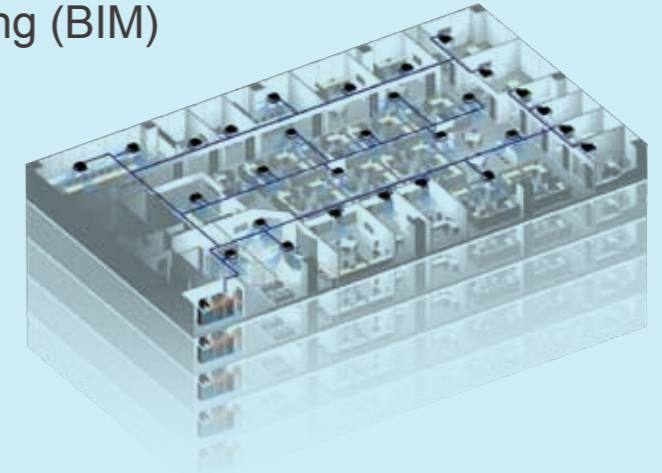

### Automatically create model selection information

- Each unit can be automatically set by entering the required performance, type, and temperature conditions for each indoor unit and then dragging and dropping into the outdoor unit.
- Piping and wiring diagrams can be created automatically and it is easy to set branches, grouping, and options.
- The additional refrigerant charging amount is automatically calculated when the pipe length is entered.
- It is also easy to set the remote controller groups, central controller and converters.
- The equipment list including the equipment information is created automatically.

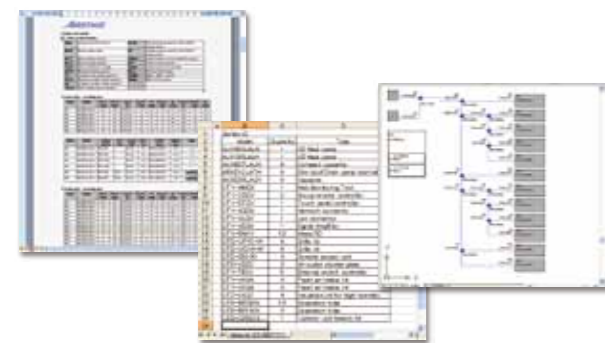

### Output the format that matches the application

The information specific to your project can be exported in a number of industry standard file formats.

- Word format (rtf)
- Excel format (csv)
- Auto CAD format (DXF)
- 2D Data (DXF)
- 3D Data (RFA)

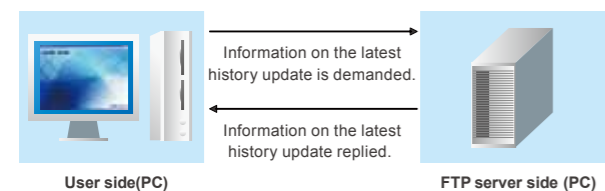

### Update your Design Simulator

Database can be easily updated online using AutoUpdate function through FTP.

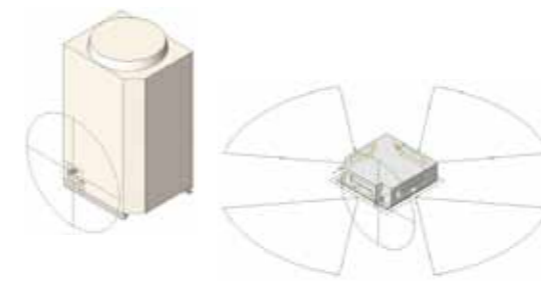

### 3D and 2D product data

We provide 3D data that closely resemble the actual product appearance. 2D CAD design operations are supported and 2D display is also provided. The data can also be output in other formats, such as DXF and DWG, which are used by other design CAD.

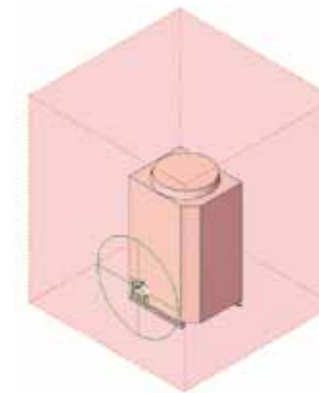

### Installation limitation

The equipment installation limitation range is shown. Installation requirements, such as distance from the wall, is automatically displayed to make it easy to produce highly reliable layout designs.



### Installation information

Other information, such as symbols showing the airflow direction that are required for installation drawings, is built in and can be automatically reflected in 2D drawings. Installation drawings can be created easily.

### Product specifications & link information

Contains the basic information required for air conditioner design, including unit size, capacity, input power, noise, and airflow rate. These data can be procured from the Fujitsu General Website, Design Simulator, and Autodesk® Seek Website.

## Fujitsu General aims for the realization of quick service and maintenance.

If trouble should occur in a unit or system, abundant support tools such as trouble code display at the product, Service Tool that allows checking of the detailed status of the entire system, and remote monitoring tool that uses the internet, etc. support quick service and maintenance anywhere and at any time.

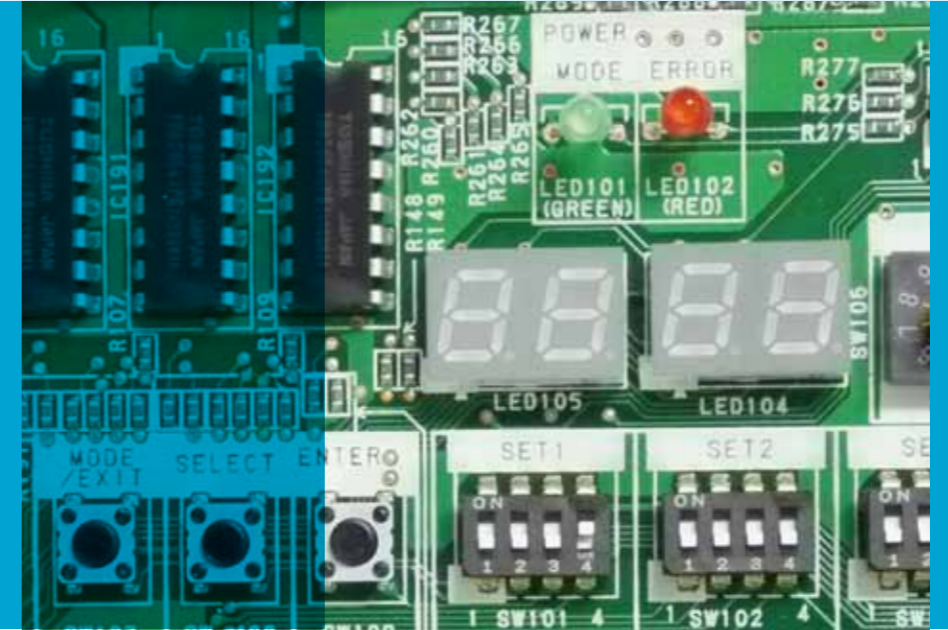

### Design for easy maintenance

The air conditioner operating status and trouble status of the detailed are displayed at the 7-segment of the outdoor unit PCB or on the remote controller screen. The unit status can be checked rapidly and quick response is also possible.

Wired Remote Controller (Touch panel)

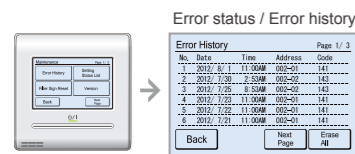

Wired Remote Controller

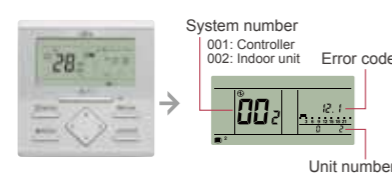

- Operation mode status
- Discharge temperature / Pressure status
- Compressor operation indication
- Address / Type / Number of outdoor unit
- Error code

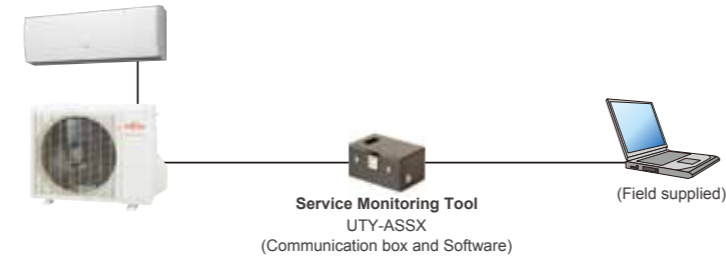

### Error diagnosis by Service Tool

The unit status details from single split models to VRF system can be checked on PC screen by connecting Service Tool. Quick countermeasures can be taken

- Operation status / control
- Monitoring operating condition
- Monitoring sensor data
- Indication of trend graph
- Error history
- Indication of refrigerant circuit diagram (for VRF)

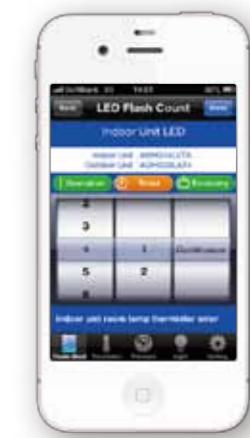
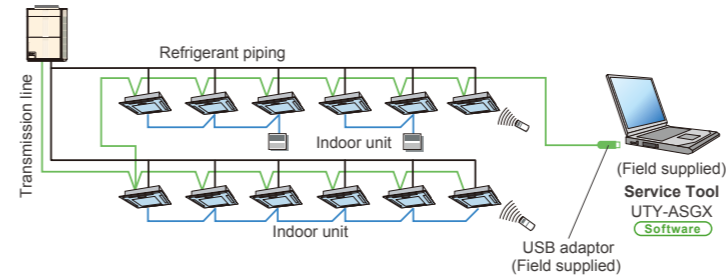

Mobile Technician **FREE**



### Mobile trouble shooting tool for iPhone

We will release an App of troubleshooting tool for iPhone, iPod touch and other Apple products.

This application is a troubleshooting tool for FUJITSU GENERAL air conditioner (RAC / PAC, VRF)

It helps you to check air conditioner condition. Error code check, Troubleshooting, and Sensor check are available.

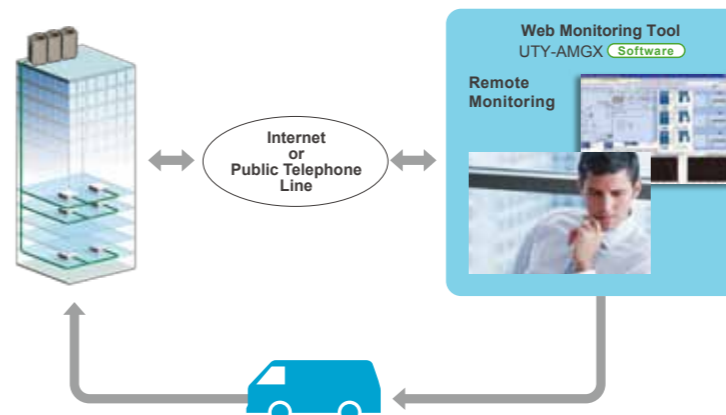

### Remote monitoring

VRF system operating status and trouble status details can be constantly and remotely monitored over the Internet, etc. Rapid cooperation with the service personnel are also possible.

# Fujitsu General following the EU climate action plan 20/20/20 by 2020

## 20% less Primary Energy Use

Fujitsu General products with high efficiency and therefore low electricity input and low primary energy usage

## 20% less CO<sub>2</sub> Emissions

Fujitsu General products sharply following the F-Gas regulation 842 / 2006 / EC

## 20% share of Renewable Energy

Fujitsu General promoting air sourced heat pumps as renewable energy source heating systems

## Pursuit of Energy Saving Taking Actual Operation into Consideration

The heat load varies greatly depending on the time and season. However, the operation ratio EER or COP up to now has been calculated based on the rated value and the annual operating hours per outdoor temperatures was not taken into consideration.

For this reason, SEER and SCOP\* have been made the standard in terms of actual operating hours throughout the year.

\*: SEER = Seasonal Energy Efficiency Ratio  
SCOP = Seasonal Coefficient Of Performance

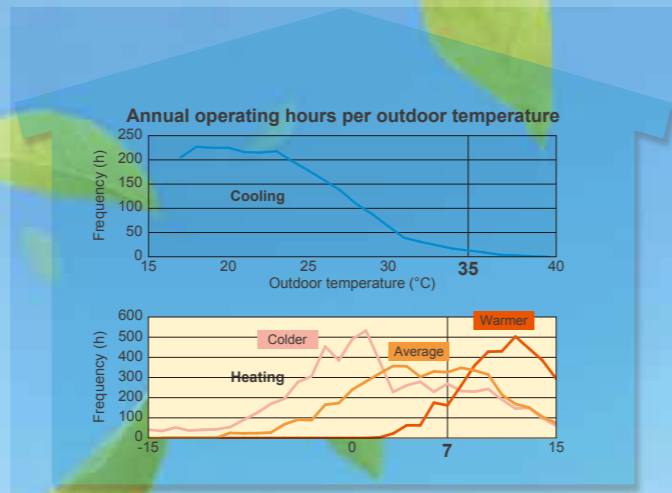

**Fujitsu General provides air conditioners with higher SEER and SCOP.**

\*SEER and SCOP are indexes that express the annual energy efficiency calculated based on the regulations of (EU) 626/2011.

## Energy Efficiency Classifications

**New Energy Labelling Requirement 626 / 2011 / EU** : Our models have reached the "Class A" ranking, the highest energy efficiency level that is now shown on energy labels in Europe.

### Current Energy Label

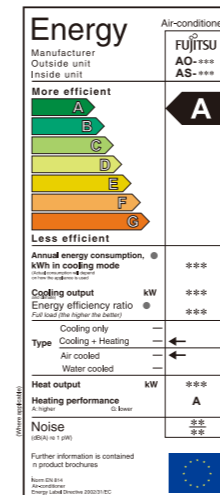

- Performance notation based on multiple points calculations that better matches the actual operation
- Energy labelling revision
- Raising of the CLASS A level

- Three climate zone for heating (Average zone : mandatory) (Warmer and colder zone are optional)
- Seasonal efficiency
- Sound power level

	EER (Cooling mode)	COP (Heating mode)
<b>A</b>	3.20 < EER	3.60 < COP
<b>B</b>	3.20 ≥ EER > 3.00	3.60 ≥ COP > 3.40
<b>C</b>	3.00 ≥ EER > 2.80	3.40 ≥ COP > 3.20
<b>D</b>	2.80 ≥ EER > 2.60	3.20 ≥ COP > 2.80
<b>E</b>	2.60 ≥ EER > 2.40	2.80 ≥ COP > 2.60
<b>F</b>	2.40 ≥ EER > 2.20	2.60 ≥ COP > 2.40
<b>G</b>	2.20 ≥ EER	2.40 ≥ COP

### Gradual ranking regulation up to A+++ (2013 ~ 2019)

- 2013~: A, B, C, D, E, F, G
- 2015~: A+, A, B, C, D, E, F
- 2017~: A++, A+, A, B, C, D, E
- 2019~: A+++, A++, A+, A, B, C, D

\* Enforcement on January 1, 2013 Air conditioners below 12 kW

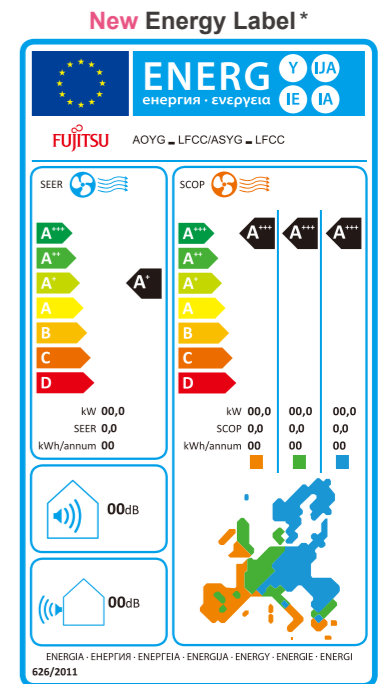

	SEER (Cooling mode)	SCOP (Heating mode)
<b>A+++</b>	SEER ≥ 8.50	SCOP ≥ 5.10
<b>A++</b>	6.10 ≤ SEER < 8.50	4.60 ≤ SCOP < 5.10
<b>A+</b>	5.60 ≤ SEER < 6.10	4.00 ≤ SCOP < 4.60
<b>A</b>	5.10 ≤ SEER < 5.60	3.40 ≤ SCOP < 4.00
<b>B</b>	4.60 ≤ SEER < 5.10	3.10 ≤ SCOP < 3.40
<b>C</b>	4.10 ≤ SEER < 4.60	2.80 ≤ SCOP < 3.10
<b>D</b>	3.60 ≤ SEER < 4.10	2.50 ≤ SCOP < 2.80
<b>E</b>	3.10 ≤ SEER < 3.60	2.20 ≤ SCOP < 2.50
<b>F</b>	2.60 ≤ SEER < 3.10	1.90 ≤ SCOP < 2.20
<b>G</b>	SEER < 2.60	SCOP < 1.90

### Current Energy Labelling Points

- Rated efficiency**
  - Full capacity
  - One point temperature condition
  - EER COP
- Operating power consumption**
- Sound pressure level**

Annual efficient operation

Reduce total power consumption

Low noise products

### New Energy Labelling Points

- Seasonal efficiency**
  - Integrates part load capacity
  - Optimised for several rating temperatures
  - SEER SCOP
- Total power consumption**
  - Operating power consumption
  - Standby power consumption
  - Crank case heater
  - Thermo off
- Sound power level**
  - New criteria

# New VRF systems

Page 110~

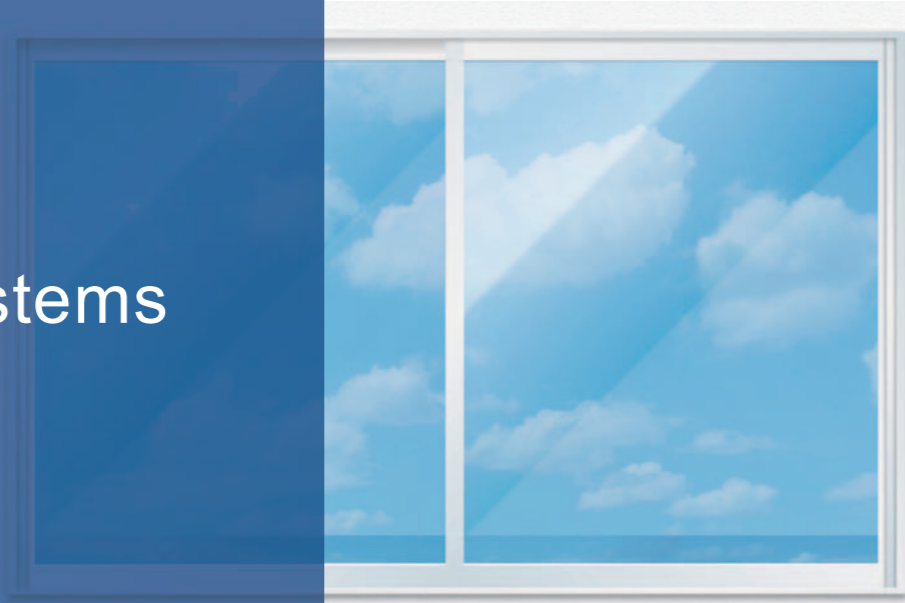

## AIRSTAGE™ J-IIS

**NEW** Small VRF system

**Features**

- Small and light weight design
- High seasonal energy efficiency
- Effective air intake grill design
- Adopting high performance twin rotary compressor
- Lineup from 4HP to 6HP



# New Air to Water systems



## WATERSTAGE™



**NEW** Wired Remote Controller

**Features**

- Various timer (ON/OFF/Weekly)
- Easy one touch operation
- Automatic address setting
- Error code and error history display



**NEW** Outdoor Air Unit

**Features**

- 100% outdoor air intake possible
- Compact size and high static pressure 200 Pa (22.4 kW)
- High energy saving by adopting DC motor



**NEW** DX-Kit for air handling applications

**Features**

- Possible to connect the air handling unit and the fan coil unit
- Optimal control with multiple temperature sensors
- Support a wide range of capacity classes (from 5 kW to 50 kW)
- Connectable to AIRSTAGE™ (J-IIS, J-II, V-II, VR-II) series

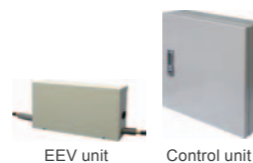

**Future Release**

**NEW** 5-kW Monobloc series

**Features**

- 55°C hot water supply even at -20°C outdoor temperature
  - Heating and DHW in one system\*
- \*Optional parts are required.

**Future Release**





AIR CONDITIONERS LINEUP  
**PRODUCT**  
 CATALOGUE 2014



SPLIT

038



MULTI SPLIT

068

OPTIONAL PARTS  
 for SPLIT & MULTI SPLIT

092



V R F

100



VENTILATION

162

OPTIONAL PARTS  
 for VRF























































170



AIR TO WATER

176

- 002 Creation of Comfort
- 004 Corporate History
- 006 High Quality Development & Production Facilities
- 007 High Quality Assurance
- 008 Global Business Activities
- 010 Core Technology
- 022 AIRSTAGE™ Support
- 024 Design Support Tool
- 026 Service and Maintenance
- 028 Approach to New Energy Efficiency Standard
- 030 2014 Fujitsu General Solutions
- 034 All Type Lineup
- 190 Feature Explanation

SPLIT		2.0	2.6	3.5	4.1	5.3	7.1	8.8	10.6	12.5	14.0	15.0	20.0	25.0
Capacity (kW)		7	9	12	14	18	24	30	36	45	54	60	72	90
Model Code		7	9	12	14	18	24	30	36	45	54	60	72	90
Wall Mounted Page 40 ~	High Spec. & Design INVERTER		 ASYG09LTCA	 ASYG12LTCA										
	High COP INVERTER	 ASYG07LUCA	 ASYG09LUCA	 ASYG12LUCA	 ASYG14LUCA									
	Standard INVERTER	 ASYG07LMCA	 ASYG09LMCA	 ASYG12LMCA	 ASYG14LMCA	 ASYG18LFCA	 ASYG24LFCC	 ASYG30LFCA						
	Basic INVERTER	<b>NEW</b>  ASYG07LLCC	<b>NEW</b>  ASYG09LLCC	<b>NEW</b>  ASYG12LLCC										
Floor Page 50	INVERTER		 AGYG09LVCA	 AGYG12LVCA	 AGYG14LVCA									
Compact Cassette / Cassette Page 52 ~	INVERTER			 AUYG12LVLB	 AUYG14LVLB	 AUYG18LVLB	 AUYG24LVLA	 AUYG30LRLE	 AUYG36LRLE AUYG36LRLA [3phase]	 AUYG45LRLA AUYG45LRLA [3phase]	 AUYG54LRLA AUYG54LRLA [3phase]			
Floor/Ceiling Page 56	INVERTER					 ABYG18LVTB	 ABYG24LVTA							
Ceiling Page 58	INVERTER							 ABYG30LRTE	 ABYG36LRTE ABYG36LRTA [3phase]	 ABYG45LRTA ABYG45LRTA [3phase]	 ABYG54LRTA [3phase]			
Slim Duct Page 60	INVERTER			 ARYG12LLTB	 ARYG14LLTB	 ARYG18LLTB								
Medium Static Pressure Duct Page 62	INVERTER						 ARYG24LMLA	 ARYG30LMLE	 ARYG36LMLE ARYG36LMLA [3phase]	 ARYG45LMLA ARYG45LMLA [3phase]				
High Static Pressure Duct Page 64 ~	INVERTER									 ARYG45LHTA ARYG45LHTA [3phase]	 ARYG54LHTA ARYG54LHTA [3phase]	 ARYG60LHTA [3phase]	 ARYG72LHTA [3phase]	 ARYG90LHTA [3phase]
MULTI SPLIT														
Up to 2 Units Page 72	INVERTER			 AOYG14LAC2	 AOYG18LAC2									
Up to 3 Units Page 72	INVERTER				 AOYG18LAT3		 AOYG24LAT3							
Up to 4 Units Page 72	INVERTER							 AOYG30LAT4						
Up to 8 Units Page 74	INVERTER									 AOYG45LBT8				
Simultaneous Multi Twin / Triple Page 90	INVERTER								 AOYG36LATT [3phase]	 AOYG45LATT [3phase]	 AOYG54LATT [3phase]			

VRF		All <b>INVERTER</b> Models																						
Capacity (kW)		12.1	14.0	15.1-15.5	22.4	28.0	33.5	40.0	45.0	50.4	55.9	61.5												
HP		4	5	6	8	10	12	14	16	18	20	22												
J-IIS series <b>NEW</b> Heat Pump Page 110 ~																								
	Set Model	AJY040CLAH	AJY045CLAH	AJY054CLAH																				
J-II series Heat Pump Page 114 ~																								
	Set Model	AJYA40LALH	AJYA45LALH	AJYA54LALH																				
V-II series Heat Pump	Space saving Page 118 ~																							
	Set Model				AJYA72LALH	AJYA90LALH	AJY108LALH	AJY126LALH	AJY144LALH	AJY162LALH	AJY180LALH	AJY198LALH												
V-II series Heat Pump	Energy efficiency Page 118 ~																							
	Set Model							AJY144LALHH			AJY198LALHH													
VR-II series Heat Recovery	Space saving Page 126 ~																							
	Set Model				AJYA72GALH	AJYA90GALH	AJY108GALH	AJY126GALH	AJY144GALH	AJY162GALH	AJY180GALH	AJY198GALH												
VR-II series Heat Recovery	Energy efficiency Page 126 ~																							
	Set Model							AJY144GALHH			AJY198GALHH													

VENTILATION							
Airflow rate (m³/h)	250	350	500	800	1000	1500	2000
Energy Recovery Ventilator Page 164							
	UTZ-BD025B	UTZ-BD035B	UTZ-BD050B	UTZ-BD080B	UTZ-BD100B		
Outdoor Air Unit Page 166							
					ARXH 054GTAH	ARXH 072GTAH	ARXH 096GTAH

AIR TO WATER		All <b>INVERTER</b> Models						
Capacity (kW)		5	6	8	10	11	14	16
Split	High Power series Single phase Page 178 Hydraulic Unit / Outdoor Unit							
						WSYG140DC6 / WOYG112LCT	WSYG140DC6 / WOYG140LCT	
	3 phase Page 178 Hydraulic Unit / Outdoor Unit							
						WSYK160DC9 / WOYK112LCT	WSYK160DC9 / WOYK140LCT	WSYK160DC9 / WOYK160LCT
Split DHW integrated	Comfort series Page 178 Hydraulic Unit / Outdoor Unit							
		WSYA050DD6 / WOYA060LDC	WSYA100DD6 / WOYA060LDC	WSYA100DD6 / WOYA080LDC	WSYA100DD6 / WOYA100LDT			
	High Power series Single phase Page 179 Hydraulic Unit / Outdoor Unit							
						WGYG140DD6 / WOYG112LCT	WGYG140DD6 / WOYG140LCT	
Monobloc	3 phase Page 179 Hydraulic Unit / Outdoor Unit							
						WGYK160DD9 / WOYK112LCT	WGYK160DD9 / WOYK140LCT	WGYK160DD9 / WOYK160LCT
	Comfort series Page 179 Hydraulic Unit / Outdoor Unit							
		WGYA050DD6 / WOYA060LDC	WGYA100DD6 / WOYA060LDC	WGYA100DD6 / WOYA080LDC	WGYA100DD6 / WOYA100LDT			
Monobloc	Compact model Page 180							
				WPYA080LE	WPYA100LE			



Energy saving design to provide a comfortable indoor environment while being environment-friendly.

An air conditioner that is people-friendly is also environment-friendly. Fujitsu General offers a broad lineup of products from large living rooms to bedrooms and children's rooms. We make your room more comfortable with a wide range of air conditioner types from ceiling wall type with automatic filters and cleaning functions to wall mounted type that improve the air cleaning function. Of course these models feature highly efficient operation that conserves electricity.

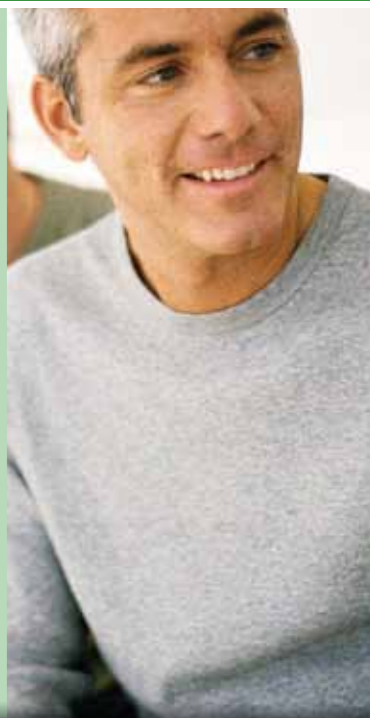

## 9 types 54 models

- 040** Wall Mounted
- 050** Floor
- 052** Compact Cassette
- 054** Cassette
- 056** Floor/Ceiling
- 058** Ceiling
- 060** Slim Duct
- 062** Medium Static Pressure Duct
- 064** High Static Pressure Duct

SPLIT



## High Spec. & Design : ASYG09LTCA / ASYG12LTCA



### Features

#### Thin & Slim design

Thin and slim design is realized by high density multi-path heat exchanger and high efficiency wind blower.

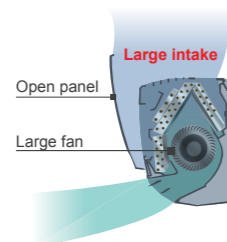

#### Powerful heating

Rated heating capacity is maintained up to an outdoor temperature lower than -7 °C. This new model can operate even at -20 °C low outdoor temperature.

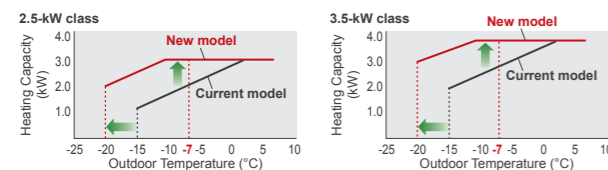

#### Powerful operation mode

20 minutes continuous operation by maximum airflow and maximum compressor speed is possible. Rapid cooling and heating makes the room comfortable quickly.

#### 10°C HEAT Operation

The room temperature can be set to go no lower than 10°C, thus ensuring that the room does not get too cold when not occupied.  
\*Only available with Wireless RC.

#### Low noise mode for outdoor unit

Low noise mode of outdoor unit can be selected by wireless remote controller.

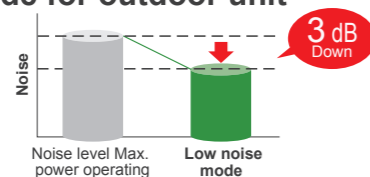

#### Energy saving control

Human sensor catches movements of people in a room, and operates with lower capacity when people leave the room. When people come back to the room, it automatically returns to previous operating mode.



#### 3 Mode timer (Weekly/Program/Sleep)

Weekly timer can be easily set by wireless remote controller. ON, OFF can be set up to 4 times in 1 day and up to 28 times in 1 week. For other modes, program timer and sleep timer can be also selected by one push.

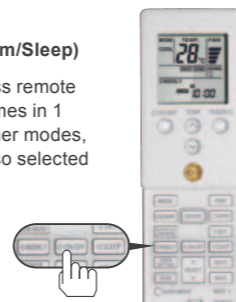

#### Low ambient operation

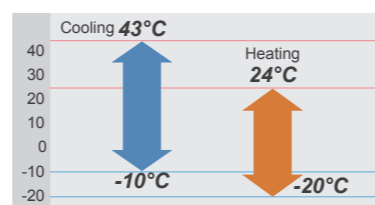

#### Optional parts

- Wired Remote Controller: UTY-RNNYM / UTY-RVNYM
- Simple Remote Controller: UTY-RSNYM
- Communication kit: UTY-TWBXF

### Specifications

Model No.	Indoor unit		Outdoor unit		ASYG09LTCA	ASYG12LTCA
	ASYG09LTCA		ASYG12LTCA		AOYG09LTC	AOYG12LTC
Power Source			V/∅/Hz		230/1/50	230/1/50
Capacity	Cooling		kW		2.5 (0.9-3.5)	3.5 (1.1-4.0)
	Heating		kW		3.2 (0.9-5.4)	4.0 (0.9-6.5)
Input Power	Cooling/Heating		kW		0.505/0.660	0.850/0.910
EER	Cooling		W/W		4.95	4.12
COP	Heating		W/W		4.85	4.40
Pdesign	Cooling/Heating (@-10°C)		kW		2.5/3.0	3.5/4.0
SEER	Cooling		W/W		8.50	8.50
SCOP	Heating (Average)		W/W		4.60	4.60
Energy Efficiency Class	Cooling				A+++	A+++
	Heating (Average)				A++	A++
Running Current	Cooling/Heating		A		2.6/3.3	4.0/4.3
Annual Energy Consumption	Cooling		kWh/a		103	144
	Heating		kWh/a		912	1217
Moisture Removal			l/h		1.3	1.8
Sound Pressure (Cooling)	Indoor	H/M/L/Q			42/36/32/21	43/37/32/21
	Outdoor	High	dB(A)		48	48
Sound Power (Cooling)	Indoor	High			59	60
	Outdoor	High			63	64
Airflow Rate (High)	Indoor / Outdoor		m³/h		800/1,700	850/2,050
			mm		282×870×185	282×870×185
Net Dimension H x W x D	Indoor		kg(lbs)		9.5 (21)	9.5 (21)
			mm		540×790×290	620×790×290
	Outdoor		kg(lbs)		33 (73)	40 (88)
			mm		6.35/9.52	6.35/9.52
Drain hose Diameter (I.D./O.D.)			mm		13.8/15.8 to 16.7	13.8/15.8 to 16.7
Max Pipe Length (Pre-Charge)			m		20 (15)	20 (15)
Max Height Difference					15	15
Operation Range	Cooling		°CDB		-10 to 43	-10 to 43
	Heating		°CDB		-20 to 24	-20 to 24
Refrigerant (Global Warming Potential)					R410A (1,975)	R410A (1,975)

### Dimensions Models: ASYG09LTCA / ASYG12LTCA

(Unit : mm)

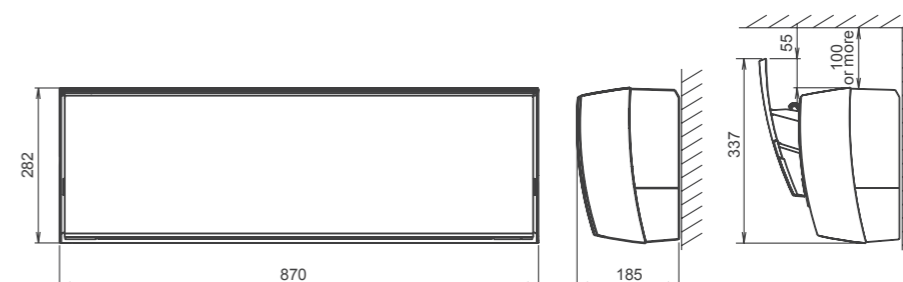

High COP : ASYG07LUCA / ASYG09LUCA / ASYG12LUCA / ASYG14LUCA



Wireless R.C.



For ASYG07/09LUCA



For ASYG12/14LUCA



## Features

### Thin & Slim design

Thin and slim design is realized by Ø5-mm heat exchanger and high efficiency wind blower.

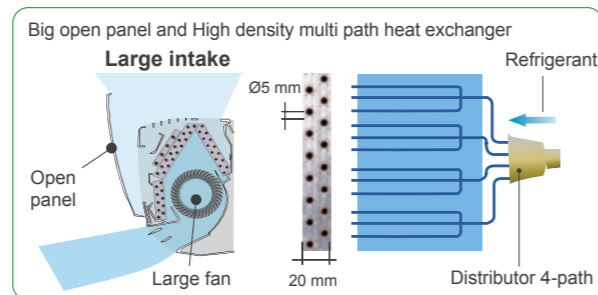

### Powerful operation

20 minutes continuous operation by maximum airflow and maximum compressor speed is possible. Rapid cooling and heating makes the room comfortable quickly.

### 10°C HEAT Operation

The room temperature can be set to go no lower than 10°C, thus ensuring that the room does not get too cold when not occupied.

\*Only available with Wireless RC.

### 3 Mode timer (Weekly/Program/Sleep)

Weekly timer can be easily set by wireless remote controller. ON, OFF can be set up to 4 times in 1 day and up to 28 times in 1 week. For other modes, program timer and sleep timer can be also selected by one push.



### Low ambient operation

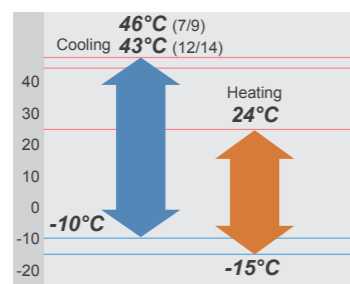

### Low noise mode for outdoor unit

Low noise mode of outdoor unit can be selected by wireless remote controller.

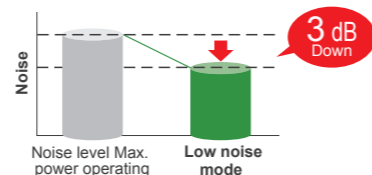

### Optional parts

- Wired Remote Controller: UTY-RNNYM, UTY-RVNYM
- Simple Remote Controller: UTY-RSNYM
- Communication kit: UTY-TWBXF

## Specifications

Model No.	Indoor unit		ASYG07LUCA	ASYG09LUCA	ASYG12LUCA	ASYG14LUCA
	Outdoor unit		AOYG07LUCA	AOYG09LUCB	AOYG12LUC	AOYG14LUC
Power Source	V/∅/Hz		230/1/50	230/1/50	230/1/50	230/1/50
Capacity	Cooling	kW	2.0 (0.5-3.0)	2.5 (0.5-3.2)	3.5 (0.9-4.0)	4.2 (0.9-5.0)
	Heating	kW	3.0 (0.5-4.0)	3.2 (0.5-4.2)	4.0 (0.9-5.6)	5.4 (0.9-6.0)
Input Power	Cooling/Heating	kW	0.460/0.660	0.555/0.680	0.905/0.930	1.235/1.380
EER	Cooling	W/W	4.35	4.50	3.87	3.40
COP	Heating	W/W	4.55	4.71	4.30	3.91
Pdesign	Cooling/Heating (@-10°C)	kW	2.0/2.6	2.5/2.8	3.5/3.9	4.2/4.8
SEER	Cooling	W/W	7.20	7.10	7.05	6.78
SCOP	Heating (Average)	W/W	4.10	4.10	4.00	4.00
Energy Efficiency Class	Cooling		A++	A++	A++	A++
	Heating (Average)		A+	A+	A+	A+
Running Current	Cooling/Heating	A	2.6/3.4	3.1/3.4	4.6/4.7	5.8/6.3
Annual Energy Consumption	Cooling	kWh/a	97	123	174	217
	Heating	kWh/a	887	956	1363	1677
Moisture Removal		l/h	1.0	1.3	1.8	2.1
Sound Pressure (Cooling)	Indoor	H/M/L/Q	38/35/31/21	42/36/32/21	43/37/32/21	45/40/33/25
	Outdoor	High	46	48	50	50
Sound Power (Cooling)	Indoor	High	57	59	60	60
	Outdoor	High	58	60	65	65
Airflow Rate (High)	Indoor / Outdoor	m³/h	680/1,720	800/1,720	850/1,940	900/1,940
Net Dimension H x W x D	Indoor	mm	282×870×185	282×870×185	282×870×185	282×870×185
		kg(lbs)	9.5 (21)	9.5 (21)	9.5 (21)	9.5 (21)
	Outdoor	mm	540×660×290	540×660×290	540×790×290	540×790×290
		kg(lbs)	23 (51)	25 (55)	33 (73)	34 (75)
Piping Connections (Small / Large)		mm	6.35/9.52	6.35/9.52	6.35/9.52	6.35/12.7
Drain Hose Diameter (I.D./O.D.)			13.8/15.8 to 16.7	13.8/15.8 to 16.7	13.8/15.8 to 16.7	13.8/15.8 to 16.7
Max Pipe Length (Pre-Charge)		m	20 (15)	20 (15)	20 (15)	20 (15)
Max Height Difference			15	15	15	15
Operation Range	Cooling	°CDB	-10 to 46	-10 to 46	-10 to 43	-10 to 43
	Heating	°CDB	-15 to 24	-15 to 24	-15 to 24	-15 to 24
Refrigerant (Global Warming Potential)			R410A (1,975)	R410A (1,975)	R410A (1,975)	R410A (1,975)

Dimensions Models : ASYG07LUCA / ASYG09LUCA / ASYG12LUCA / ASYG14LUCA

(Unit : mm)

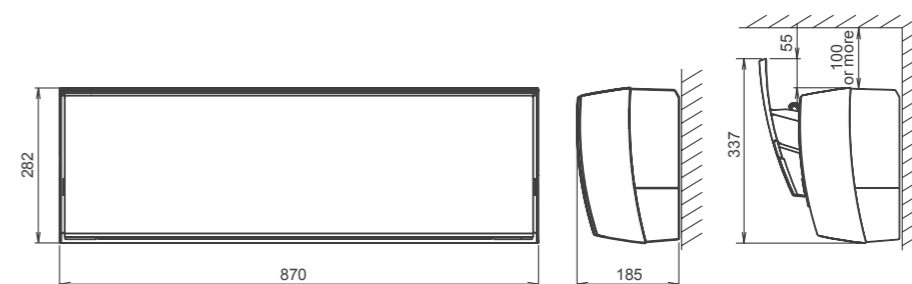

Standard : ASYG07LMCA / ASYG09LMCA / ASYG12LMCA / ASYG14LMCA



## Features

### High efficient compact design

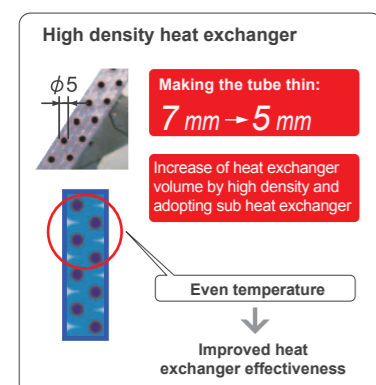

### More comfort airflow

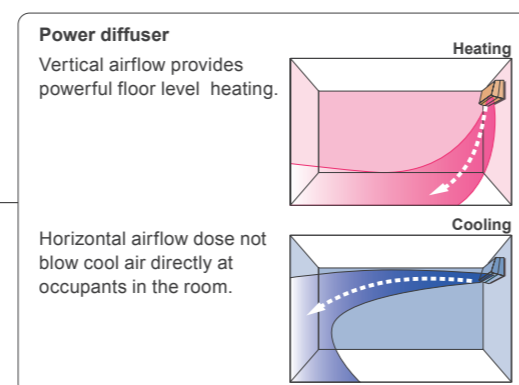

### Powerful operation

20 minutes continuous operation by maximum airflow and maximum compressor speed is possible. Rapid cooling and heating makes the room comfortable quickly.

### 24 hr Programmable timer

24 hr program timer and sleep timer can be easily set.



### 10°C HEAT Operation

The room temperature can be set to go no lower than 10°C, thus ensuring that the room does not get too cold when not occupied

### Low ambient operation

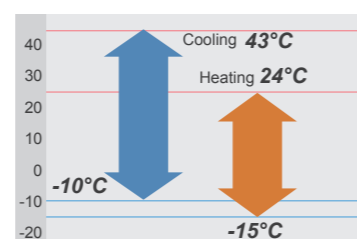

### Low noise mode for outdoor unit

Low noise mode of outdoor unit can be selected by wireless remote controller.

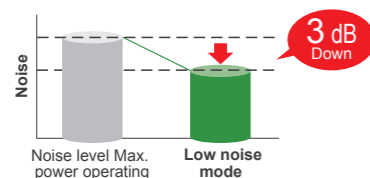

### Optional parts

- Wired Remote Controller: UTY-RNNYM, UTY-RVNYM
- Simple Remote Controller: UTY-RSNYM
- Communication kit: UTY-XCBXZ2

## Specifications

Model No.	Indoor unit		ASYG07LMCA	ASYG09LMCA	ASYG12LMCA	ASYG14LMCA
	Outdoor unit		AOYG07LMCA	AOYG09LMCA	AOYG12LMCA	AOYG14LMCA
Power Source	V/∅/Hz		230/1/50	230/1/50	230/1/50	230/1/50
Capacity	Cooling	kW	2.0 (0.5-3.0)	2.5 (0.5-3.2)	3.4 (0.9-3.9)	4.0 (0.9-4.4)
	Heating	kW	3.0 (0.5-3.4)	3.2 (0.5-4.0)	4.0 (0.9-5.3)	5.0 (0.9-6.0)
Input Power	Cooling/Heating	kW	0.465/0.685	0.65/0.73	0.97/1.02	1.135/1.365
EER	Cooling	W/W	4.30	3.85	3.50	3.52
COP	Heating	W/W	4.38	4.38	3.92	3.66
Pdesign	Cooling/Heating (@-10°C)	kW	2.0/2.3	2.5/2.4	3.4/3.5	4.0/3.9
SEER	Cooling	W/W	6.80	7.00	7.00	6.90
SCOP	Heating (Average)	W/W	4.10	4.10	4.00	4.00
Energy Efficiency Class	Cooling		A++	A++	A++	A++
	Heating (Average)		A+	A+	A+	A+
Running Current	Cooling/Heating	A	2.5/3.3	3.2/3.5	4.6/4.8	5.3/6.3
Annual Energy Consumption	Cooling	kWh/a	103	125	170	203
	Heating	kWh/a	786	820	1225	1365
Moisture Removal		l/h	1.0	1.3	1.8	2.1
Sound Pressure (Cooling)	Indoor	H/M/L/Q	43/40/32/21	43/40/32/21	43/40/32/21	44/40/33/25
	Outdoor	High	45	45	50	49
Sound Power (Cooling)	Indoor	High	59	59	59	60
	Outdoor	High	58	58	61	63
Airflow Rate (High)	Indoor / Outdoor	m³/h	750/1670	750/1670	750/1830	750/1800
		mm	268X840X203	268X840X203	268X840X203	268X840X203
Net Dimension H x W x D	Indoor	kg(lbs)	8.5 (19)	8.5 (19)	8.5 (19)	8.5 (19)
	Outdoor	kg(lbs)	535X663X293 21 (46)	535X663X293 26 (57)	535X663X293 34 (75)	540X790X290 34 (75)
Piping Connections (Small / Large)		mm	6.35/9.52	6.35/9.52	6.35/9.52	6.35/12.7
Drain Hose Diameter (I.D./O.D.)			13.8/15.8 to 16.7	13.8/15.8 to 16.7	13.8/15.8 to 16.7	13.8/15.8 to 16.7
Max Pipe Length (Pre-Charge)		m	20 (15)	20 (15)	20 (15)	20 (15)
Max Height Difference			15	15	15	15
Operation Range	Cooling	°CDB	-10 to 43	-10 to 43	-10 to 43	-10 to 43
	Heating	°CDB	-15 to 24	-15 to 24	-15 to 24	-15 to 24
Refrigerant (Global Warming Potential)			R410A (1,975)	R410A (1,975)	R410A (1,975)	R410A (1,975)

Dimensions Models : ASYG07LMCA / ASYG09LMCA / ASYG12LMCA / ASYG14LMCA (Unit : mm)

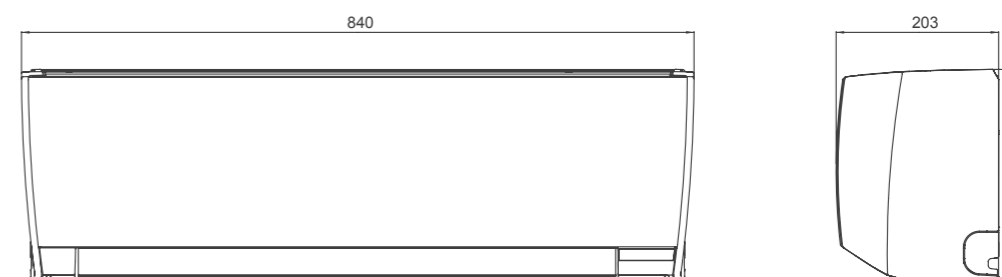

Basic : ASYG07LLCC / ASYG09LLCC / ASYG12LLCC



Wireless R.C.



## Features

### High efficient compact design

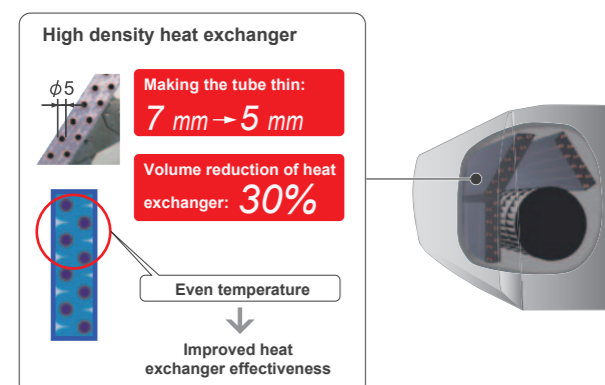

### ON-OFF Programmable timer

You can set an integrated ON-OFF or OFF-ON timer suitable for your life style.  
(Setting time: 0.5, 1, 1.5, 2, 2.5, -----9.5, 10, 11, 12 hours)

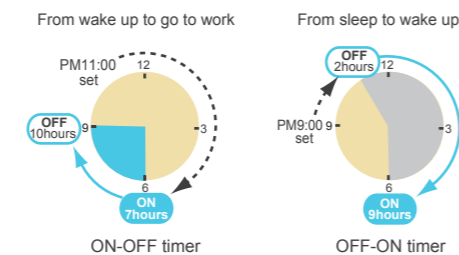

### Super Quiet Operation

Top class low noise operation by new airflow construction. Our quiet operation makes the more comfortable environment in a bed room and a study room, etc.



### Powerful operation

20 minutes continuous operation by maximum airflow and maximum compressor speed is possible. Rapid cooling and heating makes the room comfortable quickly.

### Economy operation

Setting temp. is shifted by 1°C automatically.

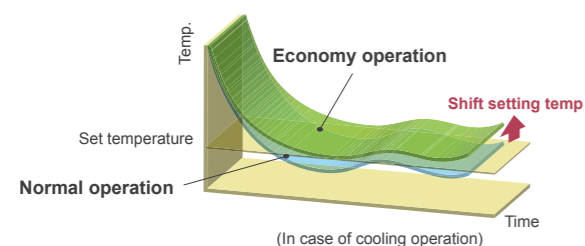

### Low ambient operation

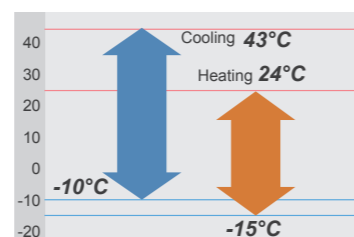

### Optional parts

Remote Controller Holder: UTZ-RXLA

## Specifications

Model No.	Indoor unit		ASYG07LLCC	ASYG09LLCC	ASYG12LLCC
	Outdoor unit		AOYG07LLCC	AOYG09LLCC	AOYG12LLCC
Power Source	V/∅/Hz		230/1/50	230/1/50	230/1/50
Capacity	Cooling	kW	2.0 (0.9-2.8)	2.5 (0.9-3.0)	3.4 (0.9-3.8)
	Heating	kW	2.7 (0.9-3.6)	3.0 (0.9-3.8)	4.0 (0.9-5.0)
Input Power	Cooling/Heating	kW	0.470/0.620	0.730/0.740	1.080/1.130
EER	Cooling	W/W	4.26	3.42	3.15
COP	Heating	W/W	4.35	4.05	3.54
Pdesign	Cooling/Heating (@-10°C)	kW	2.0/2.2	2.5/2.3	3.4/3.2
SEER	Cooling	W/W	6.70	6.90	6.60
SCOP	Heating (Average)	W/W	4.00	4.00	3.80
Energy Efficiency Class	Cooling		A++	A++	A++
	Heating (Average)		A+	A+	A
Running Current	Cooling/Heating	A	2.6/3.0	3.5/3.5	5.2/5.4
Annual Energy Consumption	Cooling	kWh/a	104	127	180
	Heating	kWh/a	770	805	1,179
Moisture Removal		l/h	1.0	1.3	1.8
Sound Pressure (Cooling)	Indoor	H/M/L/Q	43/38/33/22	43/38/33/22	43/38/33/22
	Outdoor	High	47	47	50
Sound Power (Cooling)	Indoor	High	59	59	59
	Outdoor	High	61	61	65
Airflow Rate (High)	Indoor / Outdoor	m³/h	720/1,670	720/1,670	720/1,830
		mm	262×820×206	262×820×206	262×820×206
Net Dimension H x W x D	Indoor	kg(lbs)	7.0 (15)	7.0 (15)	7.0 (15)
	Outdoor	kg(lbs)	535×663×293 24 (53)	535×663×293 24 (53)	535×663×293 26 (57)
Piping Connections (Small / Large)		mm	6.35/9.52	6.35/9.52	6.35/9.52
Drain Hose Diameter (I.D./O.D.)			13.8/15.8 to 16.7	13.8/15.8 to 16.7	13.8/15.8 to 16.7
Max Pipe Length (Pre-Charge)		m	20 (15)	20 (15)	20 (15)
Max Height Difference			15	15	15
Operation Range	Cooling	°CDB	-10 to 43	-10 to 43	-10 to 43
	Heating	°CDB	-15 to 24	-15 to 24	-15 to 24
Refrigerant (Global Warming Potential)			R410A (1,975)	R410A (1,975)	R410A (1,975)

Dimensions Models : ASYG07LLCC / ASYG09LLCC / ASYG12LLCC

(Unit : mm)

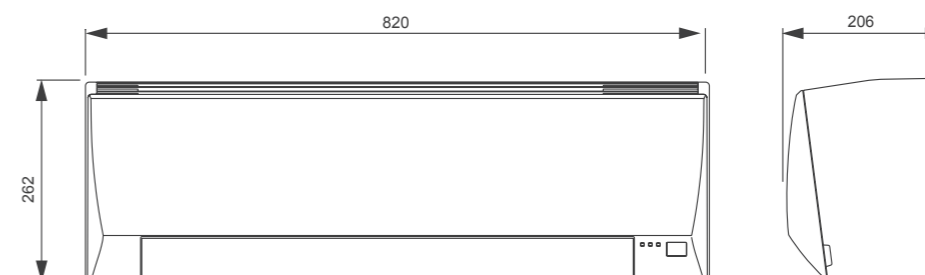



# Wall Mounted

Standard : ASYG18LFCA / ASYG24LFCC / ASYG30LFCA



Wireless R.C.



For ASYG18LFCA  
ASYG24LFCC



For ASYG30LFCA



## Features

### “Vertical airflow” provides powerful floor level heating

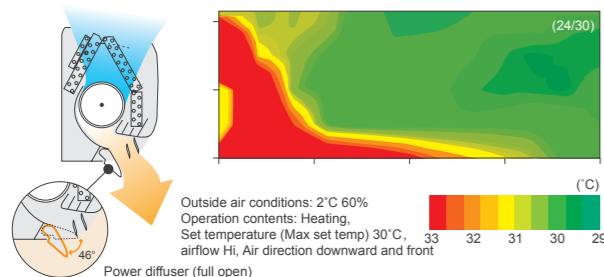

### “Horizontal airflow” does not blow cool air directly at the occupants in the room

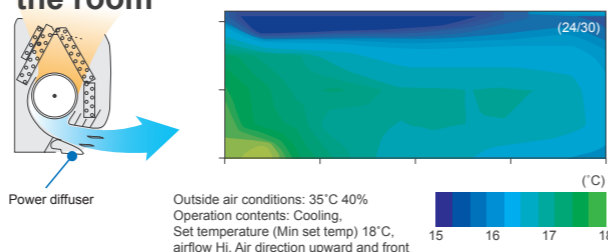

### Air conditioner filter features

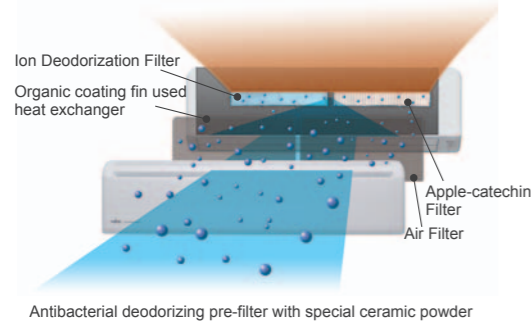

#### Ion Deodorization Filter

The filter deodorizes by powerfully decomposing absorbed odors using the oxidizing and reducing effects of ions generated by the ultra-fine-particle ceramic.

Using different filters at both sides

#### Apple-catechin Filter

The Apple-catechin filter uses static electricity to clean fine particles and dust in the air.

### Flexible Installation

	18 type	24 type	30 type
Max. Piping Length	25 m	30 m	50 m
Max. Height	20 m	20 m	30 m

### Easy maintenance

Simplification of drain pan cleaning improves maintenance-ability.

### Low ambient operation

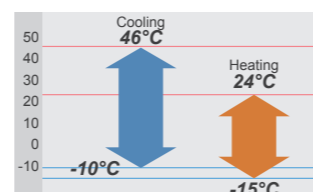

### Optional parts

Wired Remote Controller: UTY-RNNYM, UTY-RVNYM  
Simple Remote Controller: UTY-RSNYM

## Specifications

Model No.	Indoor unit		ASYG18LFCA	ASYG24LFCC	ASYG30LFCA
	Outdoor unit		AOYG18LFC	AOYG24LFCC	AOYG30LFT
Power Source	V/∅/Hz		230/1/50	230/1/50	230/1/50
Capacity	Cooling	kW	5.2 (0.9-6.0)	7.1 (0.9-8.0)	8.0 (2.9-9.0)
	Heating	kW	6.3 (0.9-9.1)	8.0 (0.9-10.6)	8.8 (2.2-11.0)
Input Power	Cooling/Heating	kW	1.52/1.71	2.20/2.21	2.49/2.44
EER	Cooling	W/W	3.42	3.23	3.21
COP	Heating	W/W	3.68	3.61	3.61
Pdesign	Cooling/Heating (@-10°C)	kW	5.2/5.9	7.1/7.1	8.0/8.0
SEER	Cooling	W/W	6.94	6.11	5.69
SCOP	Heating (Average)	W/W	3.87	3.80	3.80
Energy Efficiency Class	Cooling		A++	A++	A+
	Heating (Average)		A	A	A
Running Current	Cooling/Heating	A	6.8/7.6	9.7/9.7	10.9/10.7
Annual Energy Consumption	Cooling	kWh/a	262	406	492
	Heating	kWh/a	2130	2610	2941
Moisture Removal		l/h	2.6	2.7	3.2
Sound Pressure (Cooling)	Indoor	H/M/L/Q	43/37/33/26	49/42/37/32	48/42/37/33
	Outdoor	High	50	55	53
Sound Power (Cooling)	Indoor	High	58	64	64
	Outdoor	High	65	68	68
Airflow Rate (High)	Indoor / Outdoor	m³/h	900/2150	1120/2460	1100/3600
		mm	320X998X238	320X998X238	320X998X238
Net Dimension H x W x D	Indoor	kg(lbs)	14 (31)	14 (31)	14 (31)
	Outdoor	kg(lbs)	620X790X298 41 (90)	620X790X298 41 (90)	830X900X330 61 (135)
Piping Connections (Small / Large)		mm	6.35/12.8	6.35/15.88	9.52/15.88
Drain Hose Diameter (I.D./O.D.)			12/16	12/16	12/16
Max Pipe Length (Pre-Charge)		m	25 (15)	30 (15)	50 (20)
Max Height Difference			20	20	30
Operation Range	Cooling	°CDB	-10 to 46	-10 to 46	-10 to 46
	Heating	°CDB	-15 to 24	-15 to 24	-15 to 24
Refrigerant (Global Warming Potential)			R410A (1,975)	R410A (1,975)	R410A (1,975)

## Dimensions Models : ASYG18LFCA / ASYG24LFCC / ASYG30LFCA

(Unit : mm)

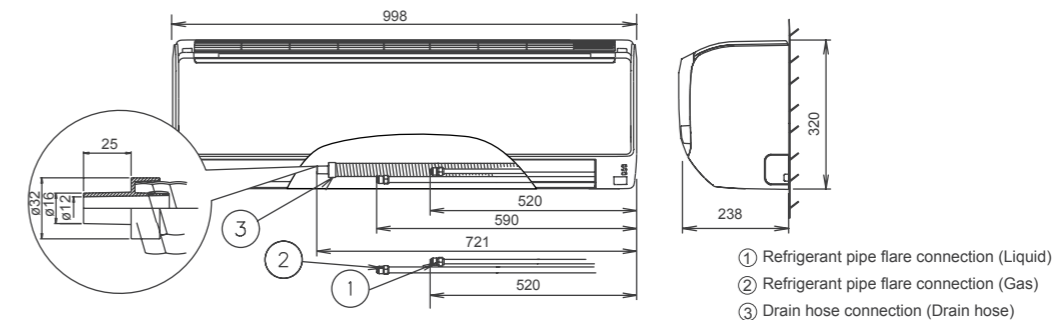

Model : AGYG09LVCA / AGYG12LVCA / AGYG14LVCA



Wireless R.C.



For AGYG09/12LVCA



For AGYG14LVCA



Features

Flexible & easy installation

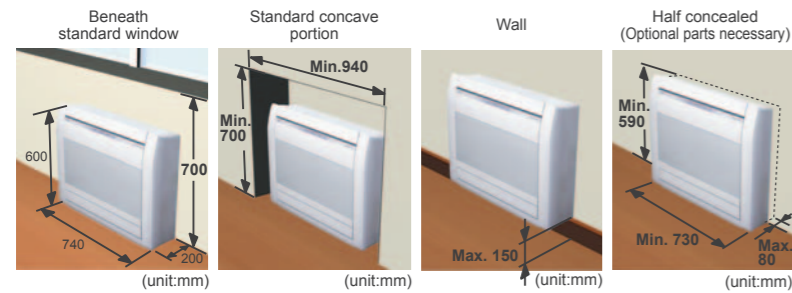

2-Fan & Wide airflow

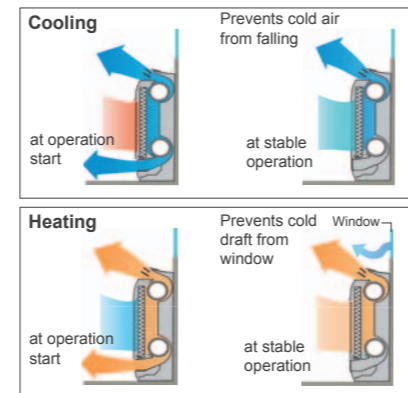

Filter features

**Ion Deodorization Filter**  
The filter deodorizes by powerfully decomposing absorbed odors using the oxidizing and reducing effects of ions generated by the ultra-fine-particle ceramic.

Using different filters at both sides

**Apple-catechin Filter**  
The Apple-catechin filter uses static electricity to clean fine particles and dust in the air.

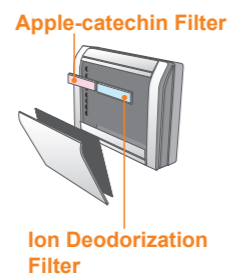

Flexible piping connection 6 direction of drain & piping

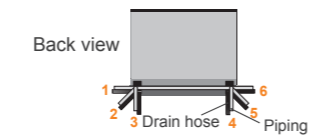

Low ambient operation

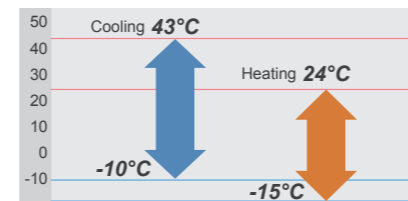

Optional parts

- Wired Remote Controller: UTY-RNNYM, UTY-RVNYM
- Simple Remote Controller: UTY-RSNYM
- Half Concealed Kit: UTR-STA

Specifications

Model No.	Indoor unit		AGYG09LVCA	AGYG12LVCA	AGYG14LVCA
	Outdoor unit		AOYG09LVCA	AOYG12LVCA	AOYG14LVLA
Power Source		V/∅/Hz	230/1/50	230/1/50	230/1/50
Capacity	Cooling	kW	2.6 (0.-3.5)	3.5 (0.9-4.0)	4.2 (0.9-5.0)
	Heating	kW	3.5 (0.9-5.5)	4.5 (0.9-6.6)	5.2 (0.9-8.0)
Input Power	Cooling/Heating	kW	0.53/0.79	0.94/1.19	1.14/1.44
EER	Cooling	W/W	4.91	3.72	3.68
COP	Heating	W/W	4.43	3.78	3.61
Pdesign	Cooling/Heating (@-10°C)	kW	2.6/2.9	3.5/3.8	4.2/4.7
SEER	Cooling	W/W	7.00	6.50	6.40
SCOP	Heating (Average)	W/W	4.20	4.00	4.00
Energy Efficiency Class	Cooling		A++	A++	A++
	Heating (Average)		A+	A+	A+
Running Current	Cooling/Heating	A	2.6/3.8	4.4/5.5	5.2/6.4
Annual Energy Consumption	Cooling	kWh/a	130	188	230
	Heating	kWh/a	967	1330	1645
Moisture Removal		l/h	1.3	1.8	2.1
Sound Pressure (Cooling)	Indoor	H/M/L/Q	40/35/29/22	40/35/29/22	44/38/31/22
	Outdoor	High	47	48	50
Sound Power (Cooling)	Indoor	High	55	55	58
	Outdoor	High	64	64	65
Airflow Rate (High)	Indoor / Outdoor	m³/h	570/1680	570/1680	650/1910
		mm	600x740x200	600x740x200	600x740x200
Net Dimension H x W x D	Indoor	kg(lbs)	14 (31)	14 (31)	14 (31)
	Outdoor	kg(lbs)	540x790x290 36 (79)	540x790x290 40 (88)	578x790x300 40 (88)
Piping Connections (Small / Large)		mm	6.35/9.52	6.35/9.52	6.35/12.7
Drain Hose Diameter (I.D./O.D.)			13.8/15.8 to 16.7	13.8/15.8 to 16.7	13.8/15.8 to 16.7
Max Pipe Length (Pre-Charge)		m	20 (15)	20 (15)	20 (15)
Max Height Difference			15	15	15
Operation Range	Cooling	°CDB	-10 to 43	-10 to 43	-10 to 43
	Heating	°CDB	-15 to 24	-15 to 24	-15 to 24
Refrigerant (Global Warming Potential)			R410A (1,975)	R410A (1,975)	R410A (1,975)

Dimensions Models : AGYG09LVCA / AGYG12LVCA / AGYG14LVCA

(Unit : mm)

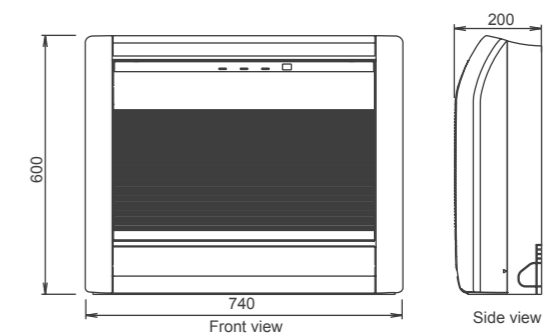

# Compact Cassette

Model : AUYG12LVLB / AUYG14LVLB / AUYG18LVLB / AUYG24LVLA



Wireless R.C.



For AUYG12/14/18LVLB



For AUYG24LVLA



## Features

### 2-stage turbo fan

High efficiency design by 2 stage structure

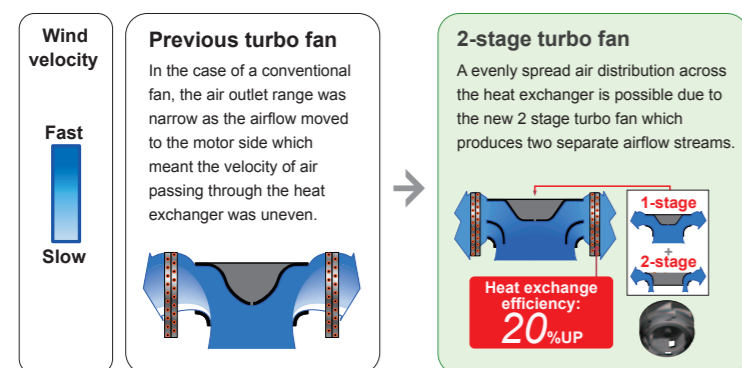

### Quiet quality

Optimization of wing form (laminar wing type) and wing number (7 blades each)

Designed by CFD-analysis (fluid) simulations

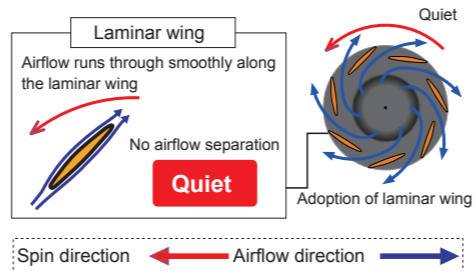

### Low ambient operation

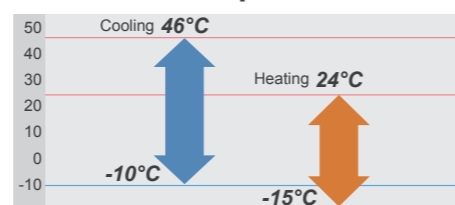

### Easy maintenance

#### 1 Maintenance of fan motor and fan

Maintenance of the fan motor and fan can be done easily after taking off the panel as the bell mouth of the fan can be removed easily.

A : Fan motor B : 2-stage turbo fan  
C : Bell-mouth D : Panel

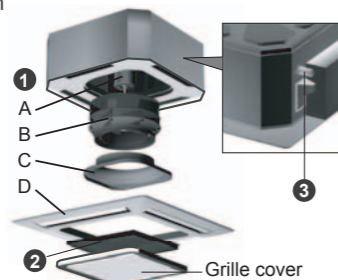

#### 2 Air filter

: standard equipment

#### 3 Adaptation of transparent drainage parts

During installation, maintenance and operation, the drain pump and kit can be checked easily.

### High lift drain pump



### Compact design

World's first 24,000Btu model in the compact cassette category (Easy installation by taking off ceiling panel of 600 x 600 size)

### Optional parts

Air Outlet Shutter Plate:	UTR-YDZB
Wired Remote Controller:	UTY-RNNYM, UTY-RVNYM
Simple Remote Controller:	UTY-RSNYM
Insulation Kit For High Humidity:	UTZ-KXGC
Fresh Air Intake Kit:	UTZ-VXAA

## Specifications

Model No.	Indoor unit		AUYG12LVLB	AUYG14LVLB	AUYG18LVLB	AUYG24LVLA
	Outdoor unit		AOYG12LALL	AOYG14LALL	AOYG18LALL	AOYG24LALA
Power Source	V/∅/Hz		230/1/50	230/1/50	230/1/50	230/1/50
Capacity	Cooling	kW	3.5 (0.9-4.4)	4.3 (0.9-5.4)	5.2 (0.9-5.9)	6.8 (0.9-8.0)
	Heating	kW	4.1 (0.9-5.7)	5.0 (0.9-6.5)	6.0 (0.9-7.5)	8.0 (0.9-9.1)
Input Power	Cooling/Heating	kW	1.05/1.11	1.33/1.34	1.62/1.66	2.21/2.26
EER	Cooling	W/W	3.33	3.21	3.21	3.08
COP	Heating	W/W	3.69	3.71	3.61	3.54
Pdesign	Cooling/Heating (@-10°C)	kW	3.5/4.2	4.3/4.5	5.2/5.2	6.8/6.0
SEER	Cooling	W/W	6.20	6.40	6.20	5.60
SCOP	Heating (Average)	W/W	4.10	4.40	4.20	3.90
Energy Efficiency Class	Cooling		A++	A++	A++	A+
	Heating (Average)		A+	A+	A+	A
Running Current	Cooling/Heating	A	4.8/5.1	6.1/6.1	7.2/7.4	9.7/9.9
Annual Energy Consumption	Cooling	kWh/a	198	235	293	425
	Heating	kWh/a	1431	1432	1731	2151
Moisture Removal		l/h	1.2	1.5	2.2	2.7
Sound Pressure (Cooling)	Indoor	H/M/L/Q	37/34/30/27	38/34/30/27	38/34/30/26	49/44/36/30
	Outdoor	High	47	49	50	52
Sound Power (Cooling)	Indoor	High	49	50	50	59
	Outdoor	High	61	62	62	67
Airflow Rate (High)	Indoor / Outdoor	m³/h	600/1780	680/1910	680/2000	930/2470
Net Dimension H x W x D	Indoor	mm	245×570×570/49×700×700	245×570×570/49×700×700	245×570×570/49×700×700	245×570×570/49×700×700
		kg(lbs)	15 (33) / 2.6 (6)	15 (33) / 2.6 (6)	15 (33) / 2.6 (6)	16 (35) / 2.6 (6)
	Outdoor	mm	578×790×300	578×790×300	578×790×300	578×790×315
		kg(lbs)	40 (88)	40 (88)	40 (88)	44 (97)
Piping Connections (Small / Large)		mm	6.35/9.52	6.35/12.70	6.35/12.70	6.35/15.88
Drain Hose Diameter (I.D./O.D.)			25/32	25/32	25/32	25/32
Max Pipe Length (Pre-Charge)		m	25 (15)	25 (15)	25 (15)	30 (15)
Max Height Difference			15	15	15	20
Operation Range	Cooling	°CDB	-10 to 46	-10 to 46	-10 to 46	-10 to 46
	Heating	°CDB	-15 to 24	-15 to 24	-15 to 24	-15 to 24
Refrigerant (Global Warming Potential)			R410A (1,975)	R410A (1,975)	R410A (1,975)	R410A (1,975)
Cassette Grille			UTG-UFYD-W	UTG-UFYD-W	UTG-UFYD-W	UTG-UFYD-W

## Dimensions Models : AUYG12LVLB / AUYG14LVLB / AUYG18LVLB / AUYG24LVLA

(Unit : mm)

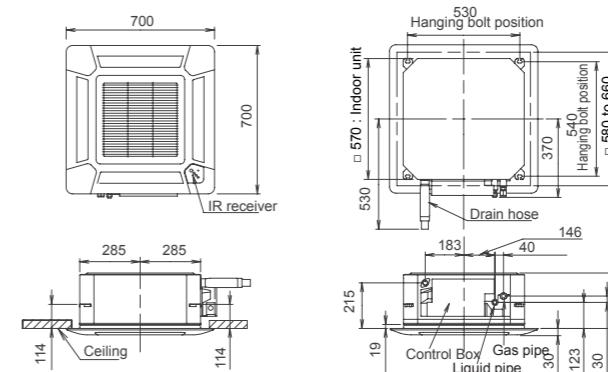

**Model :** AUYG30LRLE / AUYG36LRLE / AUYG45LRLA / AUYG54LRLA / AUYG36LRLA [3phase] / AUYG45LRLA [3phase] / AUYG54LRLA [3phase]



Wired R.C.



For AUYG30/36LRLE



For AUYG36/45/54LRLA



## Features

### High efficiency turbo fan with 3-dimensional blade

Previous turbo fan: Air passing through the heat exchanger was uneven and the air would only flow close to the ceiling.

New turbo fan: High efficiency airflow distribution has been achieved by the introduction of a 3 dimensional blade which increases the air passing over the heat exchanger.

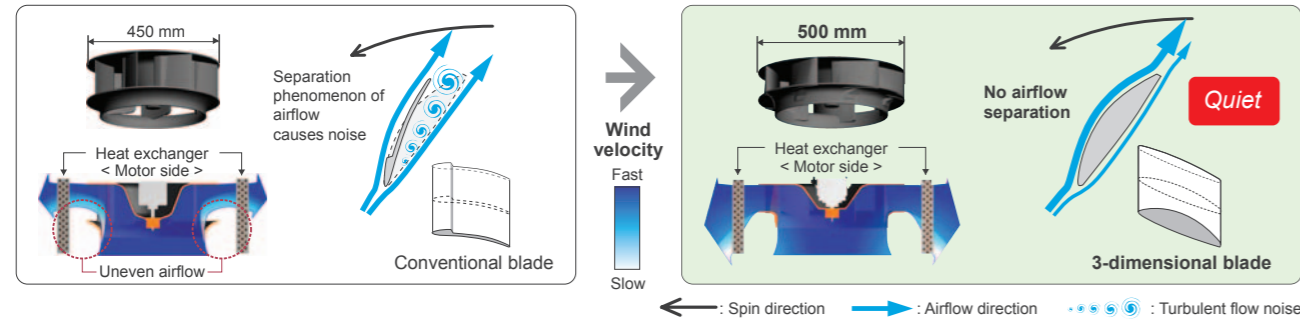

### Improvement of the airflow distribution

New louvre: The louvre design distributes air leaving a space between the chassis and the ceiling allowing far and wide airflow distribution.

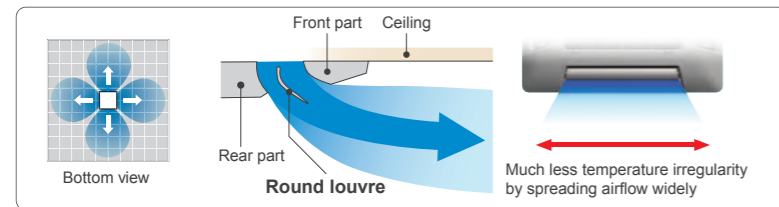

### Low ambient operation

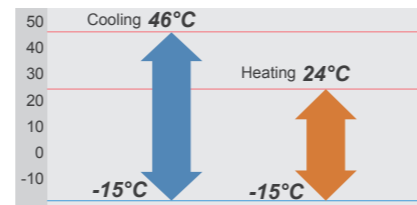

### Adjustment of hanger position is possible after installation

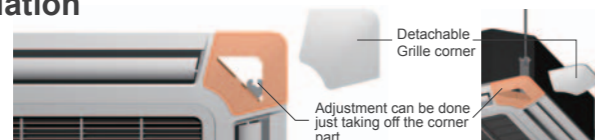

### High lift drain pump

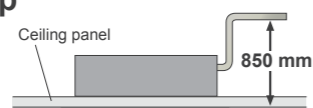

### Optional parts

- Wired Remote Controller: UTY-RNNYM, UTY-RVNYM
- Simple Remote Controller: UTY-RSNYM
- IR Receiver Kit: UTY-LRHYA2
- Wide Panel: UTG-AGYA-W
- Panel Spacer: UTG-BGYA-W
- Air Outlet Shutter Plate: UTR-YDZC
- Insulation Kit For High Humidity: UTZ-KXGA
- Fresh Air Intake Kit: UTZ-VXGA

## Specifications

Model No.	Indoor unit		AUYG30LRLE	AUYG36LRLE	AUYG45LRLA	AUYG54LRLA	AUYG36LRLA	AUYG45LRLA	AUYG54LRLA
	Outdoor unit		AOYG30LETL	AOYG36LETL	AOYG45LETL	AOYG54LETL	AOYG36LATT	AOYG45LATT	AOYG54LATT
Power Source	V/∅/Hz		230/1/50	230/1/50	230/1/50	230/1/50	400/3/50	400/3/50	400/3/50
Capacity	Cooling	kW	8.5 (2.8-10.0)	10.0 (2.8-11.2)	12.5 (4.0-14.0)	13.3 (4.5-14.5)	10.0 (4.7-11.4)	12.5 (5.0-14.0)	14.0 (5.4-16.0)
	Heating	kW	10.0 (2.7-11.2)	11.2 (2.7-12.7)	14.0 (4.2-16.2)	16.0 (4.7-16.5)	11.2 (5.0-14.0)	14.0 (5.4-16.2)	16.0 (5.8-18.0)
Input Power	Cooling/Heating	kW	2.65/2.77	3.12/3.02	3.88/3.77	4.42/4.69	2.44/2.56	3.54/3.58	4.36/4.43
EER	Cooling	W/W	3.21	3.21	3.22	3.01	4.10	3.53	3.21
COP	Heating	W/W	3.61	3.71	3.71	3.41	4.38	3.91	3.61
Pdesign	Cooling/Heating	kW	8.5/8.0	10.0/8.7	-	-	10.0/10.0	-	-
SEER	Cooling	W/W	6.50	6.30	-	-	6.50	-	-
SCOP	Heating	W/W	4.30	4.20	-	-	4.30	-	-
Energy Efficiency Class	Cooling		A++	A++	-	-	A++	-	-
	Heating		A+	A+	-	-	A+	-	-
Running Current	Cooling/Heating	A	11.6/12.2	13.7/13.3	17.0/16.5	19.3/20.5	3.7/3.9	5.3/5.3	6.5/6.6
Annual Energy Consumption	Cooling	kWh/a	458	555	-	-	573	-	-
	Heating	kWh/a	2604	2897	-	-	3253	-	-
Moisture Removal		l/h	2.5	3.5	4.5	5.0	3.0	4.5	5.0
Sound Pressure (Cooling)	Indoor	H/M/L/Q	40/38/36/32	43/38/36/32	46/42/40/36	47/43/41/37	44/39/36/33	46/42/40/36	47/43/41/37
	Outdoor	High	53	54	55	55	51	54	55
	Indoor	High	54	57	-	-	58	-	-
Sound Power (Cooling)	Indoor	High	61	61	61	61	58	-	-
	Outdoor	High	68	69	-	-	67	-	-
Airflow Rate (High)	Indoor / Outdoor	m³/h	1600/3600	1800/3800	1900/6750	2000/6750	1800/6200	1900/6900	2000/6900
Net Dimension H x W x D	Indoor	mm	288x840x840	50x950x950	288x840x840	50x950x950	288x840x840	50x950x950	288x840x840
	Outdoor	mm	830x900x330	830x900x330	1290x900x330	1290x900x330	1290x900x330	1290x900x330	1290x900x330
Piping Connections (Small / Large)		mm	9.52/15.88	9.52/15.88	9.52/15.88	9.52/15.88	9.52/15.88	9.52/15.88	9.52/15.88
Drain Hose Diameter (I.D./O.D.)		mm	25.0/32.0	25.0/32.0	25.0/32.0	25.0/32.0	25.0/32.0	25.0/32.0	25.0/32.0
Max Pipe Length (Pre-Charge)		m	50 (20)	50 (20)	50 (20)	50 (20)	75 (30)	75 (30)	75 (30)
Max Height Difference		m	30	30	30	30	30	30	30
Operation Range	Cooling	°CDB	-15 to 46	-15 to 46	-15 to 46	-15 to 46	-15 to 46	-15 to 46	-15 to 46
	Heating	°CDB	-15 to 24	-15 to 24	-15 to 24	-15 to 24	-15 to 24	-15 to 24	-15 to 24
Refrigerant (Global Warming Potential)			R410A (1,975)	R410A (1,975)	R410A (1,975)	R410A (1,975)	R410A (1,975)	R410A (1,975)	R410A (1,975)
Cassette Grille			UTG-UGYA-W	UTG-UGYA-W	UTG-UGYA-W	UTG-UGYA-W	UTG-UGYA-W	UTG-UGYA-W	UTG-UGYA-W

### Dimensions Models : AUYG30LRLE / AUYG36LRLE / AUYG36LRLA / AUYG45LRLA / AUYG54LRLA

(Unit : mm)

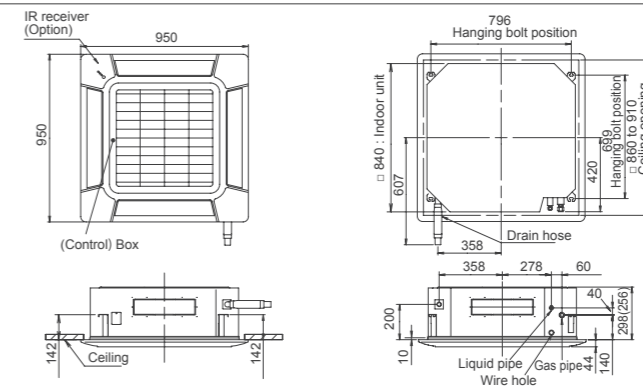

Model : ABYG18LVTB / ABYG24LVTA



## Features

### Flexible installation

#### Example for floor installation

Floor console



#### Example for ceiling installation

Under ceiling



### Double auto swing

A combination of right/left and up/down directional swing allows 3-dimensional air direction control

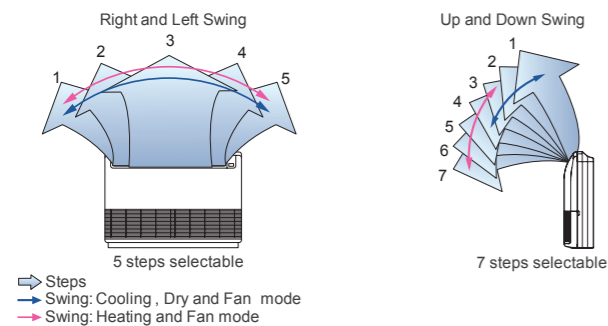

### Low ambient operation

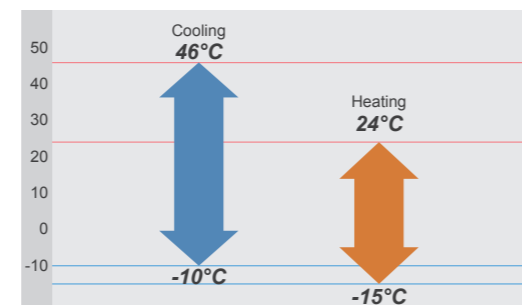

### Easy installation

Main work settings can be done easily from the remote controller at installation

#### Main work settings

- High ceiling setting
- Auto restart
- Temperature adjustment when cooling / heating

#### Optional parts

Wired Remote Controller: UTY-RNNYM, UTY-RVNYM  
Simple Remote Controller: UTY-RSNYM

## Specifications

Model No.	Indoor unit		ABYG18LVTB		ABYG24LVTA	
	Outdoor unit		AOYG18LALL		AOYG24LALA	
Power Source	V/∅/Hz		230/1/50		230/1/50	
Capacity	Cooling	kW	5.2 (0.9-5.9)		6.8 (0.9-8.0)	
	Heating	kW	6.0 (0.9-7.5)		8.0 (0.9-9.1)	
Input Power	Cooling/Heating		1.62/1.66		2.21/2.26	
	Cooling	W/W	3.21		3.08	
EER	Cooling		3.21		3.08	
	Heating		3.61		3.54	
COP	Cooling		3.21		3.08	
	Heating		3.61		3.54	
Pdesign	Cooling/Heating		5.2/5.2		6.8/6.0	
	Cooling	W/W	6.10		5.60	
SEER	Cooling		6.10		5.60	
	Heating		4.00		3.90	
SCOP	Cooling		A++		A+	
	Heating		A+		A	
Energy Efficiency Class	Cooling/Heating		A		A	
	Cooling	A	7.2/7.4		9.7/9.9	
Running Current	Cooling/Heating		A		A	
	Cooling	kWh/a	298		425	
Annual Energy Consumption	Cooling		298		425	
	Heating		1819		2150	
Moisture Removal	Cooling		2.0		2.7	
	Heating		2.0		2.7	
Sound Pressure (Cooling)	Indoor	H/M/L/Q	43/40/34/31		48/44/40/35	
	Outdoor	High	50		52	
	Indoor	High	57		61	
Sound Power (Cooling)	Indoor	High	57		61	
	Outdoor	High	62		67	
Airflow Rate (High)	Indoor / Outdoor		m³/h		m³/h	
	Indoor / Outdoor		m³/h		m³/h	
Net Dimension H x W x D	Indoor	mm	780/2000		980/2470	
		kg(lbs)	199x990x655		199x990x655	
		mm	27 (59)		27 (59)	
Piping Connections (Small / Large)	Outdoor	mm	578x790x300		578x790x315	
		kg(lbs)	40 (88)		44 (97)	
Drain Hose Diameter (I.D./O.D.)	mm		6.35/12.70		6.35/15.88	
Max Pipe Length (Pre-Charge)	m		25/32		25/32	
Max Height Difference	m		25 (15)		30 (15)	
Operation Range	Cooling		15		20	
	Heating		°CDB		°CDB	
Refrigerant (Global Warming Potential)	Cooling		-10 to 46		-10 to 46	
	Heating		-15 to 24		-15 to 24	
Refrigerant (Global Warming Potential)			R410A (1,975)		R410A (1,975)	

## Dimensions Models : ABYG18LVTB / ABYG24LVTA

(Unit : mm)

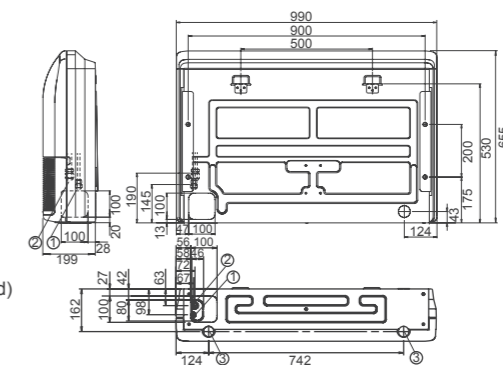

- ① Refrigerant piping flare connection (Liquid)
- ② Refrigerant piping flare connection (Gas)
- ③ Drain piping connection

**Model :** ABYG30LRTE / ABYG36LRTE / ABYG45LRTA /  
 ABYG36LRTA (3phase) / ABYG45LRTA (3phase) / ABYG54LRTA (3phase)



Wireless R.C.



For ABYG30/36LRTE



For ABYG36/45/54LRTA

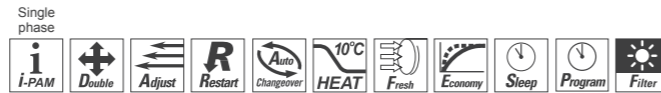

## Features

### Installation

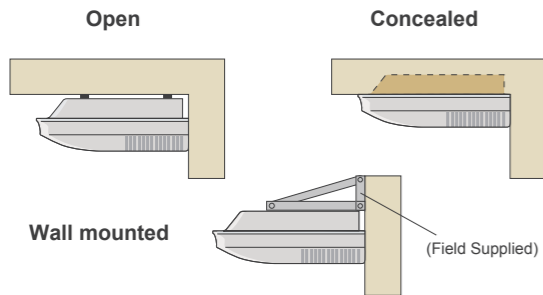

### Multi auto swing

A combination of right/left and up/down directional swing allows 3-dimensional air direction control.

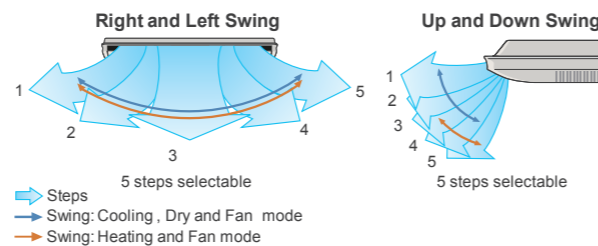

### Condensate lift-up mechanism (Option)

Optional drain lift-up mechanism allows flexible installation.

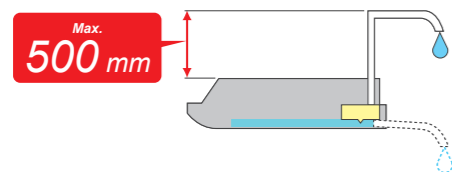

### Low ambient operation

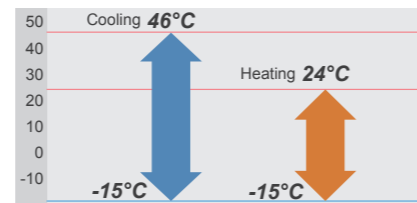

### Fresh air intake

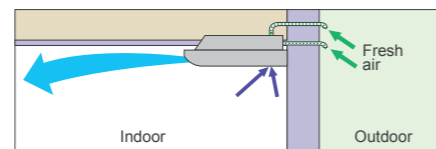

### Easy installation

Main work settings can be done easily from the remote controller at installation

- Main work settings**
- High ceiling setting
  - Auto restart
  - Temperature adjustment when cooling / heating

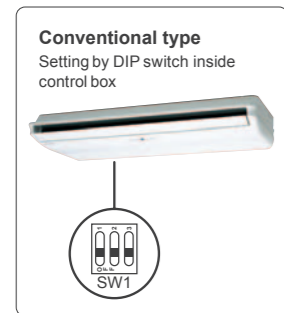

### Optional parts

- Wired Remote Controller: UTY-RNNYM, UTY-RVNYM
- Simple Remote Controller: UTY-RSNYM
- Drain Pump Unit: UTR-DPB24T
- Flange: UTD-RF204

## Specifications

Model No.	Indoor unit		ABYG30LRTE	ABYG36LRTE	ABYG45LRTA	ABYG36LRTA	ABYG45LRTA	ABYG54LRTA
	Outdoor unit		AOYG30LETL	AOYG36LETL	AOYG45LETL	AOYG36LATT	AOYG45LATT	AOYG54LATT
Power Source	V/∅/Hz		230/1/50	230/1/50	230/1/50	400/3/50	400/3/50	400/3/50
Capacity	Cooling	kW	8.5 (2.8-10.0)	9.4 (2.8-11.2)	12.1 (4.0-13.3)	10.0 (4.7-11.4)	12.5 (5.0-14.0)	14.0 (5.4-16.0)
	Heating	kW	10.0 (2.7-11.2)	11.2 (2.7-12.7)	13.3 (4.2-15.5)	11.2 (5.0-14.0)	14.0 (5.4-16.2)	16.0 (5.8-18.0)
Input Power	Cooling/Heating	kW	2.65/2.77	2.93/3.02	3.77/3.68	2.84/2.87	3.89/3.88	4.65/4.67
		W/W	3.21	3.21	3.21	3.52	3.21	3.01
EER	Cooling	W/W	3.21	3.21	3.21	3.90	3.61	3.43
	Heating	W/W	3.61	3.71	3.61	-	-	-
COP	Cooling/Heating	kW	8.5/8.0	9.4/8.7	-	10.0/10.0	-	-
		W/W	6.10	6.00	-	6.10	-	-
SEER	Cooling	W/W	4.20	4.10	-	4.10	-	-
	Heating	W/W	4.20	4.10	-	-	-	-
SCOP	Cooling	W/W	A++	A+	-	A++	-	-
	Heating	W/W	A+	A+	-	A+	-	-
Running Current	Cooling/Heating	A	11.6/12.2	12.8/13.2	16.5/16.1	4.3/4.4	5.8/5.8	6.9/6.9
Annual Energy Consumption	Cooling	kWh/a	487	548	-	573	-	-
	Heating	kWh/a	2662	2965	-	3414	-	-
Moisture Removal		l/h	2.5	3.0	4.0	3.0	4.5	5.0
Sound Pressure (Cooling)	Indoor	H/M/L/Q	45/43/37/32	47/43/37/32	49/45/39/34	47/43/37/32	49/45/39/34	51/48/42/38
	Outdoor	High	53	54	55	51	54	55
	Indoor	High	57	60	-	61	-	-
Sound Power (Cooling)	Indoor	High	68	69	-	67	-	-
	Outdoor	High	68	69	-	67	-	-
Airflow Rate (High)	Indoor / Outdoor	m³/h	1660/3600	1900/3800	2100/6200	1900/6200	2100/6900	2300/6900
		mm	240x1660x700	240x1660x700	240x1660x700	240x1660x700	240x1660x700	240x1660x700
Net Dimension H x W x D	Indoor	kg(lbs)	46 (101)	46 (101)	46 (101)	46 (101)	46 (101)	48 (106)
		mm	830x900x330	830x900x330	1290x900x330	1290x900x330	1290x900x330	1290x900x330
	Outdoor	kg(lbs)	61 (134)	61 (134)	86 (189)	104 (229)	104 (229)	104 (229)
Piping Connections (Small / Large)		mm	9.52/15.88	9.52/15.88	9.52/15.88	9.52/15.88	9.52/15.88	9.52/15.88
Drain Hose Diameter (I.D./O.D.)		mm	21.5/26.0	21.5/26.0	21.5/26.0	21.5/26.0	21.5/26.0	21.5/26.0
Max Pipe Length (Pre-Charge)		m	50 (20)	50 (20)	50 (20)	75 (30)	75 (30)	75 (30)
Max Height Difference		m	30	30	30	30	30	30
Operation Range	Cooling	°CDB	-15 to 46	-15 to 46	-15 to 46	-15 to 46	-15 to 46	-15 to 46
	Heating	°CDB	-15 to 24	-15 to 24	-15 to 24	-15 to 24	-15 to 24	-15 to 24
Refrigerant (Global Warming Potential)			R410A (1,975)	R410A (1,975)	R410A (1,975)	R410A (1,975)	R410A (1,975)	R410A (1,975)

## Dimensions Models : ABYG30LRTE / ABYG36LRTE / ABYG36LRTA / ABYG45LRTA / ABYG54LRTA

(Unit : mm)

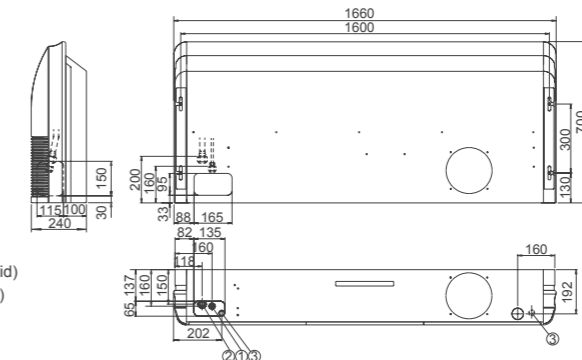

- ① Refrigerant piping flare connection (Liquid)
- ② Refrigerant piping flare connection (Gas)
- ③ Drain piping connection

Model : ARYG12LLTB / ARYG14LLTB / ARYG18LLTB



## Features

### Slim design

The slim design allows installations where ceilings are narrow.

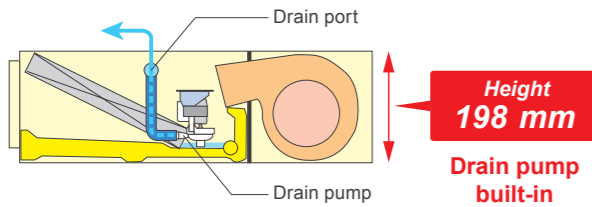

### Drain hose as standard accessory

For flexible installation.

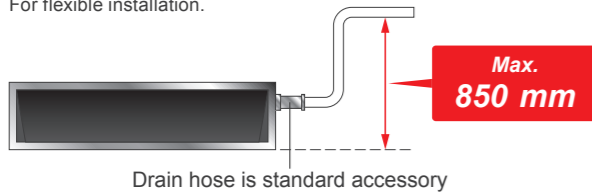

### Selectable with a wide range of static pressure

By using the DC fan motor, it is possible to change the static pressure range from 0 to 90 Pa.

The change of static pressure range is possible by remote controller.



### Air-intake

Air intake direction can be selected to match the installation site.

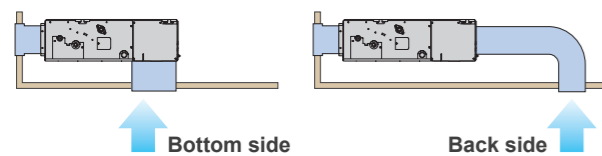

### Flexible installation

Ceiling concealed    Floor concealed



### Auto Louver Grille Kit (Option)

Simple flat Auto Louver will provide comfort airflow and harmonize with luxury interior.

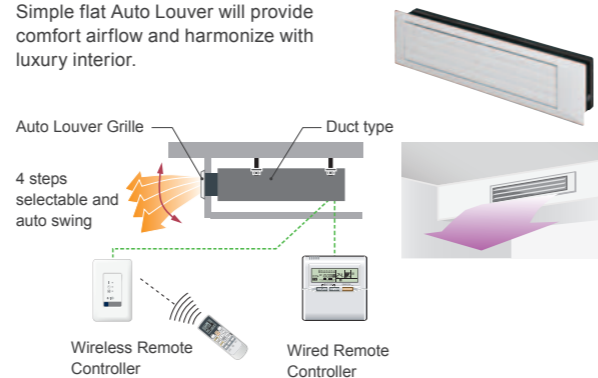

### Optional parts

- Wired Remote Controller: UTY-RNNYM, UTY-RVNYM
- Simple Remote Controller: UTY-RSNYM
- IR Receiver Kit: UTY-LRHYM
- Remote Sensor Unit: UTY-XSZX
- Auto Louver Grille Kit: UTD-GXSA-W (For ARYG12 / 14LLTB)  
UTD-GXSB-W (For ARYG18LLTB)

## Specifications

Model No.	Indoor unit		ARYG12LLTB	ARYG14LLTB	ARYG18LLTB
	Outdoor unit		AOYG12LALL	AOYG14LALL	AOYG18LALL
Power Source	V/∅/Hz		230/1/50	230/1/50	230/1/50
Capacity	Cooling	kW	3.5 (0.9-4.4)	4.3 (0.9-5.4)	5.2 (0.9-5.9)
	Heating	kW	4.1 (0.9-5.7)	5.0 (0.9-6.5)	6.0 (0.9-7.5)
Input Power	Cooling/Heating	kW	1.05/1.11	1.33/1.34	1.62/1.66
	EER	W/W	3.33	3.21	3.21
COP	Cooling	W/W	3.69	3.71	3.61
	Heating	W/W	5.90	5.80	6.20
Pdesign	Cooling/Heating	kW	3.5/4.2	4.3/4.5	5.2/5.2
	SEER	W/W	4.00	3.90	4.10
SCOP	Cooling	W/W	A+	A+	A++
	Heating	W/W	A+	A	A+
Running Current	Cooling/Heating	A	4.8/5.1	6.1/6.1	7.2/7.4
	Annual Energy Consumption	kWh/a	207	259	293
Moisture Removal	Cooling	l/h	1467	1614	1774
	Heating	l/h	1.3	1.5	2.0
Sound Pressure (Cooling)	Indoor	H/M/L/Q	29/28/26/25	32/30/28/26	32/30/29/27
	Outdoor	High	47	49	50
	Indoor	High	58	60	58
Sound Power (Cooling)	Indoor	High	61	62	62
	Outdoor	High	61	62	62
Airflow Rate (High)	Indoor / Outdoor	m³/h	650/1780	800/1910	940/2000
	Static pressure range (Standard)	Pa	0 to 90 (25)	0 to 90 (25)	0 to 90 (25)
Net Dimension H x W x D	Indoor	mm	198x700x620	198x700x620	198x900x620
	Outdoor	kg(lbs)	19 (42)	19 (42)	23 (51)
	Outdoor	mm	578x790x300	578x790x300	578x790x300
Piping Connections (Small / Large)	Indoor	kg(lbs)	40 (88)	40 (88)	40 (88)
	Outdoor	mm	6.35/9.52	6.35/12.70	6.35/12.70
Drain Hose Diameter (I.D./O.D.)	Indoor	mm	25/32	25/32	25/32
	Outdoor	mm	25 (15)	25 (15)	25 (15)
Max Pipe Length (Pre-Charge)	Indoor	m	15	15	15
	Outdoor	m	15	15	15
Max Height Difference	Cooling	°CDB	-10 to 46	-10 to 46	-10 to 46
	Heating	°CDB	-15 to 24	-15 to 24	-15 to 24
Refrigerant (Global Warming Potential)			R410A (1,975)	R410A (1,975)	R410A (1,975)

## Dimensions Models : ARYG12LLTB / ARYG14LLTB / ARYG18LLTB

(Unit : mm)

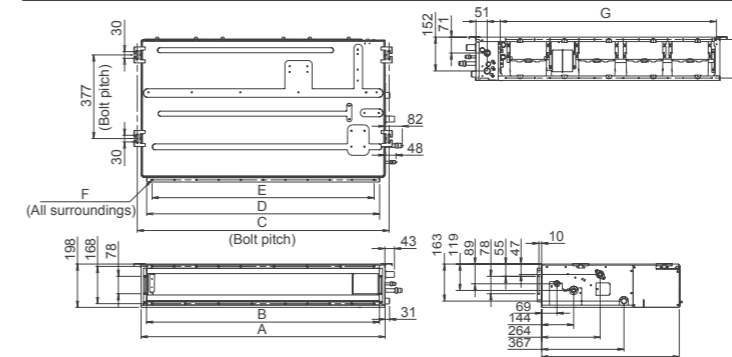

	ARYG12 / 14LLTB	ARYG18LLTB
A	700	900
B	650	850
C	734	934
D	650	850
E	P100x6=600	P100x8=800
F	18x∅5	22x∅5
G	574	774

# Medium Static Pressure Duct

Model : ARYG24LMLA / ARYG30LMLE / ARYG36LMLE / ARYG45LMLA /  
ARYG36LMLA [3phase] / ARYG45LMLA [3phase]



Wired R.C. For ARYG24LMLA For ARYG30/36LMLE For ARYG36/45LMLA



## Features

### Slim & Compact design

In the case of bottom return air connection, not only does the indoor unit design allow for installation in a narrow ceiling space of up to 270 mm, Further space savings have been achieved by mounting the control box internally inside the chassis.

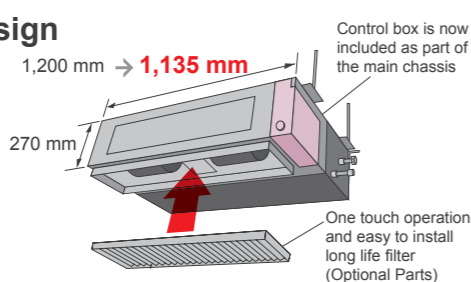

### Two-direction drain piping

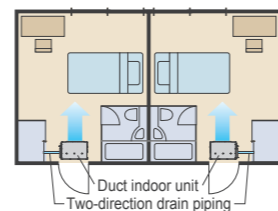

### Easy maintenance

Structural improvement is attained by making the bottom panel two pieces, front and rear. The internal fan casing is also manufactured in two pieces, namely upper and lower. The maintenance of the motor and fan can be easily carried out by removing the rear panel and the lower part of the casing while leaving the main chassis installed.

See below for the case of rear suction type

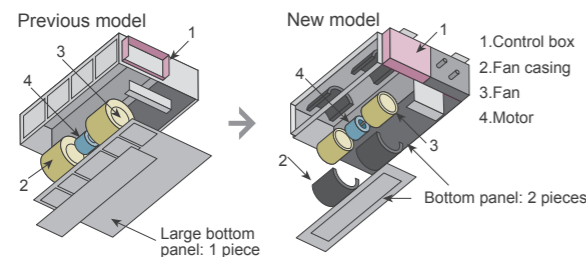

### Low ambient operation

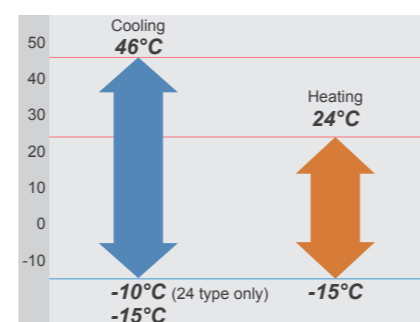

### Easy installation

Main work settings can be done easily from the remote controller at installation

**Main work settings**  
•High ceiling setting  
•Auto restart  
•Temperature adjustment when cooling / heating

**Conventional type**  
Setting by DIP switch inside control box

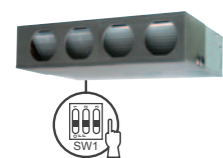

**Setting by wired remote controller**



### Optional parts

- Wired Remote Controller: UTY-RNNYM, UTY-RVNYM
- Simple Remote Controller: UTY-RSNYM
- Flange (Round): UTD-RF204
- Flange (Square): UTD-SF045T
- Long Life Filter: UTD-LF25NA
- Remote Sensor Unit: UTY-XSZX
- Drain Pump Unit: UTZ-PX1NBA
- IR Receiver Kit: UTY-LRHYM

## Specifications

Model No.	Indoor unit		ARYG24LMLA	ARYG30LMLE	ARYG36LMLE	ARYG45LMLA	ARYG36LMLA	ARYG45LMLA	
	Outdoor unit		AOYG24LALA	AOYG30LETL	AOYG36LETL	AOYG45LETL	AOYG36LATT	AOYG45LATT	
Power Source	V/∅/Hz		230/1/50	230/1/50	230/1/50	230/1/50	400/3/50	400/3/50	
Capacity	Cooling	kW	6.8 (0.9-8.0)	8.5 (2.8-10.0)	9.4 (2.8-11.2)	12.1 (4.0-13.3)	10.0 (4.7-11.4)	12.5 (5.0-14.0)	
	Heating	kW	8.0 (0.9-9.1)	10.0 (2.7-11.2)	11.2 (2.7-12.7)	13.3 (4.2-15.5)	11.2 (5.0-14.0)	14.0 (5.4-16.2)	
Input Power	Cooling/Heating		kW	2.21/2.26	2.65/2.68	2.96/3.10	3.77/3.68	2.84/2.87	3.89/3.88
EER	Cooling		W/W	3.08	3.21	3.18	3.21	3.52	3.21
COP	Heating		W/W	3.54	3.73	3.61	3.61	3.90	3.61
Pdesign	Cooling/Heating		kW	6.8/6.0	8.5/8.0	9.4/8.7	-	10.0/10.0	-
SEER	Cooling		W/W	6.20	5.90	5.70	-	5.80	-
SCOP	Heating		W/W	4.00	3.90	3.80	-	4.00	-
Energy Efficiency Class	Cooling			A++	A+	A+	-	A+	-
	Heating			A+	A	A	-	A+	-
Running Current	Cooling/Heating		A	9.7/9.9	11.6/11.7	13.0/13.6	16.5/16.1	4.3/4.4	5.8/5.8
Annual Energy Consumption	Cooling		kWh/a	384	504	576	-	603	-
	Heating		kWh/a	2098	2868	3202	-	3497	-
Moisture Removal			l/h	2.5	2.5	3.0	4.0	3.0	4.5
Sound Pressure (Cooling)	Indoor	H/M/L/Q	dB(A)	31/29/27/25	39/35/30/26	39/35/30/26	42/38/32/28	38/36/31/26	42/38/32/28
		High	52	53	54	55	51	54	
		Outdoor	60	65	65	-	65	-	
Sound Power (Cooling)	Indoor	High	67	68	69	-	67	-	
		Outdoor	67	68	69	-	67	-	
Airflow Rate (High)	Indoor / Outdoor		m³/h	1100/2470	1900/3600	1900/3800	2100/6200	1800/6200	2100/6750
Static pressure range (Standard)			Pa	30 to 150 (35)	30 to 150 (47)	30 to 150 (47)	30 to 150 (60)	30 to 150 (47)	30 to 150 (60)
			mm	270x1135x700	270x1135x700	270x1135x700	270x1135x700	270x1135x700	270x1135x700
			kg(lbs)	38 (84)	40 (88)	40 (88)	40 (88)	40 (88)	40 (88)
Net Dimension H x W x D	Indoor	mm	578x790x315	830x900x330	830x900x330	1290x900x330	1290x900x330	1290x900x330	
		kg(lbs)	44 (97)	61 (134)	61 (134)	86 (189)	104 (229)	104 (229)	
Piping Connections (Small / Large)	Indoor	mm	6.35/15.88	9.52/15.88	9.52/15.88	9.52/15.88	9.52/15.88	9.52/15.88	
		mm	35.7/38.1	35.7/38.1	35.7/38.1	35.7/38.1	35.7/38.1	35.7/38.1	
Drain Hose Diameter (I.D./O.D.)			mm	35.7/38.1	35.7/38.1	35.7/38.1	35.7/38.1	35.7/38.1	
Max Pipe Length (Pre-Charge)			m	30 (15)	50 (20)	50 (20)	50 (20)	75 (30)	75 (30)
Max Height Difference			m	20	30	30	30	30	30
Operation Range	Cooling		°CDB	-10 to 46	-15 to 46	-15 to 46	-15 to 46	-15 to 46	-15 to 46
	Heating		°CDB	-15 to 24	-15 to 24	-15 to 24	-15 to 24	-15 to 24	-15 to 24
Refrigerant (Global Warming Potential)				R410A (1,975)	R410A (1,975)	R410A (1,975)	R410A (1,975)	R410A (1,975)	R410A (1,975)

## Dimensions Models : ARYG24LMLA / ARYG30LMLE / ARYG36LMLE / ARYG36LMLA / ARYG45LMLA

(Unit : mm)

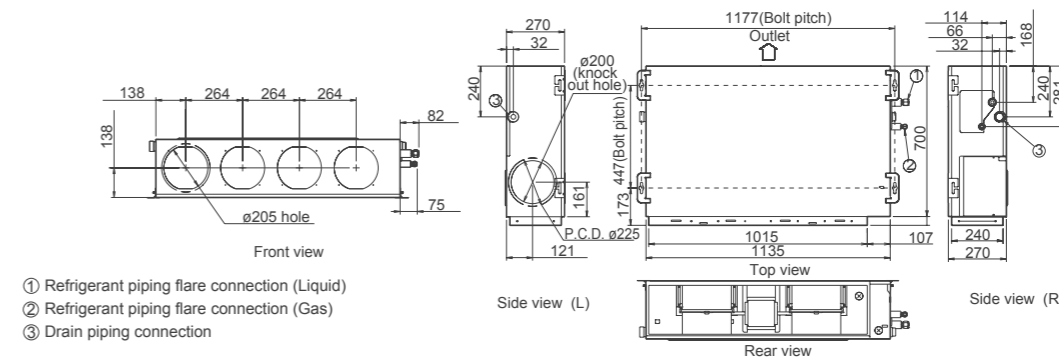



# High Static Pressure Duct

**Model :** ARYG45LHTA / ARYG54LHTA /  
ARYG45LHTA [3phase] / ARYG54LHTA [3phase] / ARYG60LHTA [3phase]



## Features

### High energy efficiency

Significantly greater efficiency is realized by using all DC inverter technology. (60 type)

### Easy installation (Compact size & Lightweight)

A compact size and lightweight indoor unit has been developed by reducing the basic chassis and the overall material weight.

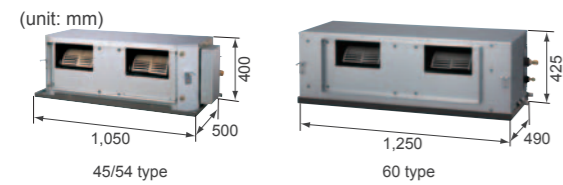

### Design also corresponding to high static pressure

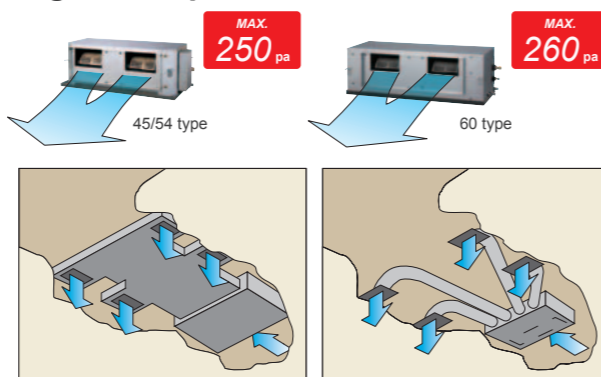

### Low noise

#### Indoor unit

Cutting off the corners has enabled less turbulent airflow. Low noise is realized by adopting a plastic case and a plastic fan.

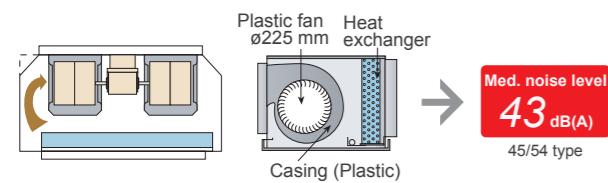

#### Outdoor unit

2 stage low noise mode can be selected. (Option)

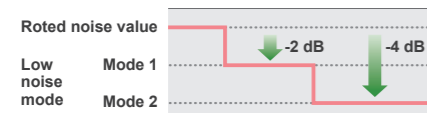

### Low ambient operation

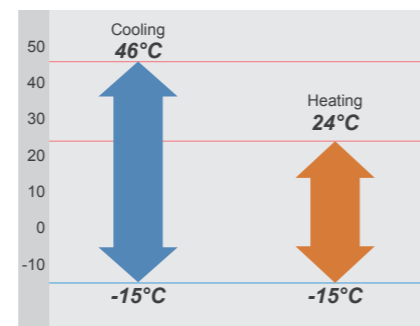

### Optional parts

- Wired Remote Controller: UTY-RNNYM, UTY-RVNYM
- Simple Remote Controller: UTY-RSNYM
- Long-Life Filter: UTD-LF60KA (For ARYG45/54LHTA only)
- Remote Sensor Unit: UTY-XSZX
- IR Receiver Kit: UTY-LRHYM (For ARYG60LHTA only)

## Specifications

Model No.	Indoor unit		ARYG45LHTA	ARYG54LHTA	ARYG45LHTA	ARYG54LHTA	ARYG60LHTA	
	Outdoor unit		AOYG45LETL	AOYG54LETL	AOYG45LATT	AOYG54LATT	AOYG60LATT	
Power Source	V/∅/Hz		230/1/50	230/1/50	400/3/50	400/3/50	400/3/50	
Capacity	Cooling	kW	12.5 (4.5-14.0)	13.4 (5.0-14.5)	12.5 (5.0-14.0)	14.0 (5.4-16.0)	15.0 (6.2-17.5)	
	Heating	kW	14.0 (5.0-16.2)	16.0 (5.5-18.0)	14.0 (5.4-16.2)	16.0 (5.8-18.0)	18.0 (6.2-20.0)	
Input Power	Cooling/Heating	kW	4.30/3.80	4.77/4.69	4.06/3.67	4.65/4.37	4.70/5.15	
EER	Cooling	W/W	2.91	2.81	3.08	3.01	3.19	
COP	Heating	W/W	3.68	3.41	3.81	3.66	3.50	
Running Current	Cooling/Heating	A	18.9/16.7	20.9/20.5	6.1/5.5	6.9/6.5	6.9/7.6	
Moisture Removal			1.5	2.0	1.5	2.5	2.0	
Sound Pressure (Cooling)	Indoor	H/M/L	47/43/40	47/43/40	47/43/40	47/43/40	45/40/36	
	Outdoor	High	55	55	54	55	56	
Airflow Rate (High)	Indoor / Outdoor	m <sup>3</sup> /h	3350/6750	3350/6750	3350/6750	3350/6900	3550/6900	
Static pressure range (Standard)			Pa	100 to 250 (100)	100 to 250 (100)	100 to 250 (100)	100 to 250 (100)	60 to 260 (60)
			mm	400x1050x500	400x1050x500	400x1050x500	400x1050x500	425x1250x490
Net Dimension H x W x D	Indoor	kg(lbs)	46 (101)	46 (101)	46 (101)	46 (101)	54 (119)	
	Outdoor	kg(lbs)	1290x900x330	1290x900x330	1290x900x330	1290x900x330	1290x900x330	1290x900x330
Piping Connections (Small / Large)			mm	9.52/15.88	9.52/15.88	9.52/15.88	9.52/15.88	9.52/15.88
Drain Hose Diameter (I.D./O.D.)			mm	23.4/25.4	23.4/25.4	23.4/25.4	23.4/25.4	23.4/25.4
Max Pipe Length (Pre-Charge)			m	50 (20)	50 (20)	75 (30)	75 (30)	75 (30)
Height Difference			m	30	30	30	30	30
Operation Range	Cooling	°CDB	-15 to 46	-15 to 46	-15 to 46	-15 to 46	-15 to 46	-15 to 46
	Heating	°CDB	-15 to 24	-15 to 24	-15 to 24	-15 to 24	-15 to 24	-15 to 24
Refrigerant			R410A	R410A	R410A	R410A	R410A	

## Dimensions Models : ARYG45LHTA / ARYG54LHTA / ARYG60LHTA

(Unit : mm)

### Model: ARYG45LHTA / ARYG54LHTA

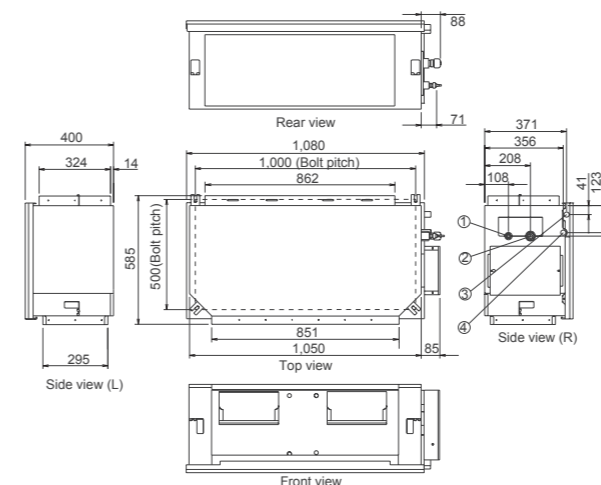

### Model: ARYG60LHTA

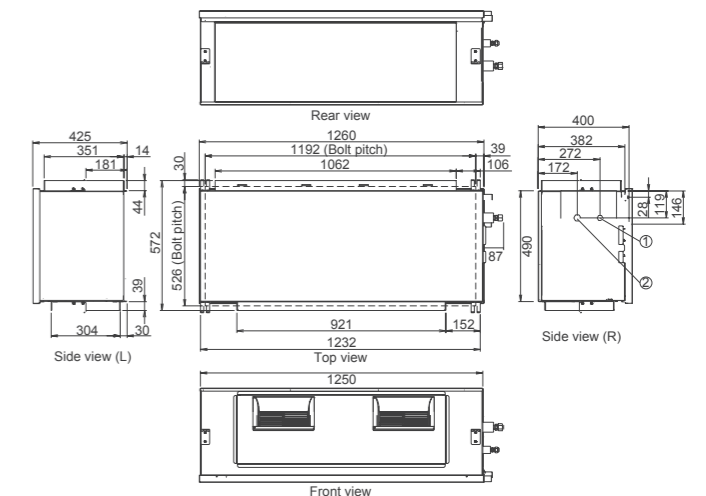

- ① Refrigerant piping flare connection (Liquid)
- ② Refrigerant piping flare connection (Gas)
- ③ Drain piping connection (Safety drain pan)
- ④ Drain piping connection (Main drain pan)

# High Static Pressure Duct

Model : ARYC72LHTA [3phase], ARYC90LHTA [3phase]



ARYC72LHTA



ARYC90LHTA



Wired R.C.



## Features

### High energy efficiency

Significantly greater efficiency is realized by using DC twin rotary compressor, all DC inverter technology, and large heat exchanger.

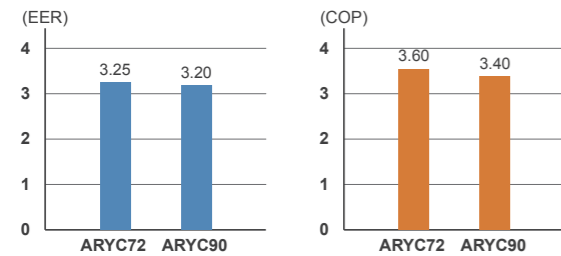

### 5 Static Pressure selection

Improvement and design flexibility has allowed multiple fan speeds and static pressure modes. Low noise is realized by adopting plastic case, plastic fan.

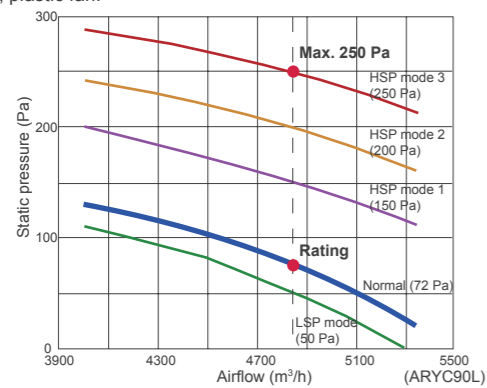

### Outdoor unit quiet operation

A low outdoor noise operation mode allows the outdoor unit to have two quiet mode operation settings.

### Peak cut operation

A peak power consumption mode controls a 4 step outdoor operation control to cut down energy usage at peak energy usage times.

### Easy Service & Maintenance

- Split front panel allows for maintenance from top or bottom of the outdoor unit
- Fan motors of the indoor unit can be removed separately

Outdoor unit

Indoor unit

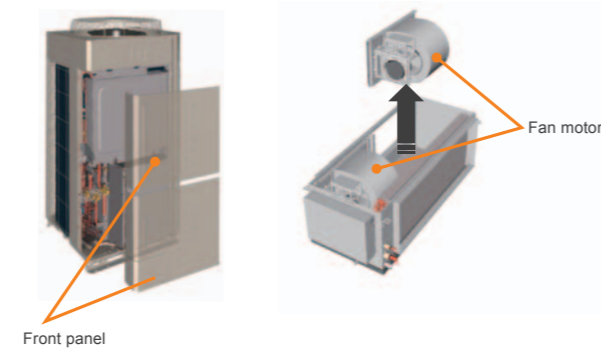

### Pursuance of amenity performance

Various remote controllers and sensors can be selected.



### Optional parts

- Wired Remote Controller: UTY-RNNYM, UTY-RVNYM
- Simple Remote Controller: UTY-RSNYM
- Remote Sensor Unit: UTY-XSZX

## Specifications

Model No.	Indoor unit		ARYC72LHTA		ARYC90LHTA	
	Outdoor unit		AOYA72LALT		AOYA90LALT	
Power Source	V/∅/Hz		400/3/50		400/3/50	
Capacity	Cooling	kW	20.3 (10.8-23.5)		25.0 (11.2-28.0)	
	Heating	kW	22.6 (12.0-26.5)		28.0 (12.5-31.5)	
Input Power	Cooling/Heating	kW	6.25/6.27		7.82/8.24	
EER	Cooling	W/W	3.25		3.20	
	Heating	W/W	3.60		3.40	
Running Current	Cooling/Heating	A	9.6/9.6		11.9/12.5	
Moisture Removal	l/h		4.5		6.0	
Sound Pressure (Cooling)	Indoor	H/M/L/Q	47/44/41		49/46/43	
	Outdoor	High	57		58	
Airflow Rate (High)	Indoor / Outdoor	m³/h	4300/9300		4850/10700	
Static pressure range (Standard)	Pa		50 to 250 (72)		50 to 250 (72)	
	mm		450x1587x700		550x1587x700	
Net Dimension H x W x D	Indoor	kg(lbs)	100 (220)		110 (242)	
	Outdoor	mm	1690x930x765		1690x930x765	
Piping Connections (Small / Large)	mm		12.70/25.40		12.70/25.40	
	kg(lbs)		215 (473)		215 (473)	
Max Pipe Length (Pre-Charge)	m		75 (20)		75 (20)	
Height Difference	m		30		30	
Operation Range	Cooling	°CDB	-5 to 46		-5 to 46	
	Heating	°CDB	-15 to 24		-15 to 24	
Refrigerant			R410A		R410A	

## Dimensions Models : ARYC72LHTA / ARYC90LHTA

(Unit : mm)

Model: ARYC72LHTA

Model: ARYC90LHTA

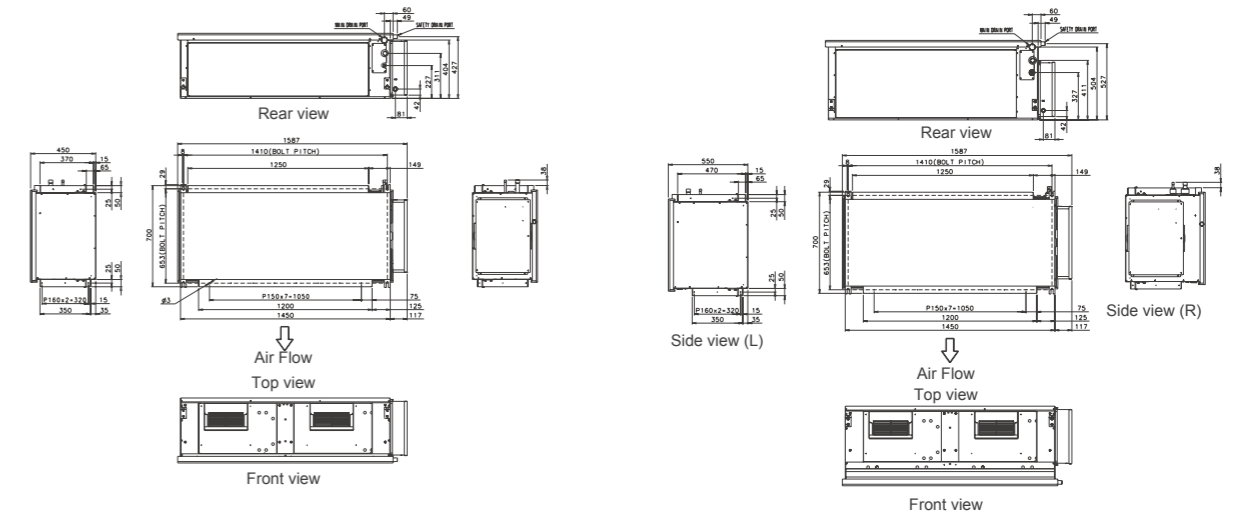

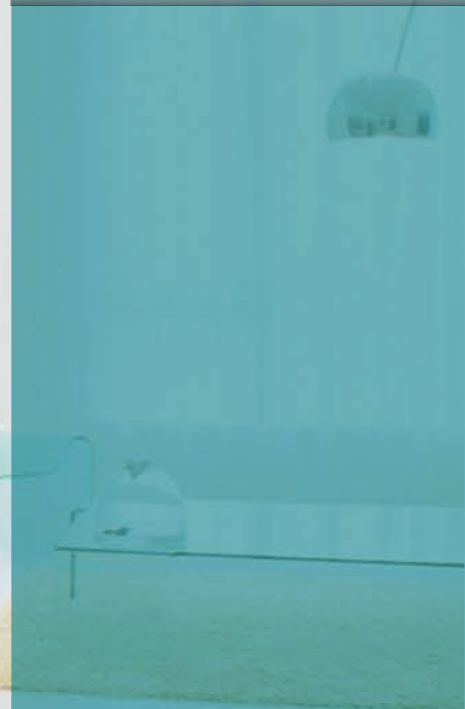

Control several indoor units  
with one outdoor unit.  
Build the optimum system you desire.

If you want to keep a large floor as well as many rooms comfortable,  
we recommend you use Multi Split to build a simple system using one  
outdoor unit.

Choose from a large lineup of indoor units that best matches your rooms.  
You can mix and match them at will.

Build the system that is just right for you.



Multi Split provides comfort in a variety of situations  
from **home** to **office** and **store**.

- 070** Multi type Line-up
- 072** 2 & 3-4 Rooms Multi
- 074** 8 Rooms Multi
- 078** Specifications of All Indoor Units
- 080** Multi Combination Table
- 090** Simultaneous Multi
- 092** Optional Parts for Split & Multi Split

MULTI SPLIT



# Multi type Line-up

## Multi Split Line-up

Model code	Capacity range					
	14	18		24	30	45
Cooling rated capacity(kW)	4	5	5.4	6.8	8	14
<b>2 Rooms Multi</b> Up to 2 units						
	●	●				
	AOYG14LAC2	AOYG18LAC2				
<b>3 Rooms Multi</b> Up to 3 units						
			●	●		
			AOYG18LAT3	AOYG24LAT3		
<b>4 Rooms Multi</b> Up to 4 units						
					●	
					AOYG30LAT4	
<b>8 Rooms Multi</b> Up to 8 units						
						●
						AOYG45LBT8

Note : 1. 2 Rooms Multi : Connectable indoor units are 2 units.  
 AOYG14LAC2 : Total capacity of indoor units connected must be between 4.0 kW and 6.2 kW.  
 AOYG18LAC2 : Total capacity of indoor units connected must be between 4.0 kW and 7.0 kW.  
 2. 3 Rooms Multi : Connectable indoor units are 2 to 3 units.  
 AOYG18LAT3 : Total capacity of indoor units connected must be between 4.0 kW and 8.5 kW.  
 AOYG24LAT3 : Total capacity of indoor units connected must be between 4.0 kW and 10.5 kW.  
 3. 4 Rooms Multi : Connectable indoor units are 3 to 4 units.  
 AOYG30LAT4 : Total capacity of indoor units connected must be between 7.9 kW and 14.4 kW.  
 4. 8 Rooms Multi : Connectable indoor units are 2 to 8 units.  
 AOYG45LBT8 : Total capacity of indoor units connected must be between 11.2 kW and 18.2 kW.

## Connectable Indoor unit line-up

Outdoor Unit	Type	2 Rooms		3 Rooms		4 Rooms	8 Rooms	
	Model name	AOYG14LAC2	AOYG18LAC2	AOYG18LAT3	AOYG24LAT3	AOYG30LAT4	AOYG45LBT8 (Branch Box)	
	Capacity (kW)	Cooling		Cooling		Cooling	Cooling	
		4.0	5.0	5.4	6.8	8.0	14.0	
		Heating		Heating		Heating	Heating	
		4.4	5.6	6.8	8.0	9.6	16.0	
Indoor Unit	BTU	kW Class						
ASYG07/09/12/14LM	7000	2.0	●	●	●	●	●	●
	9000	2.5	●	●	●	●	●	●
ASYG07/09/12/14LU	12000	3.5	●	●	●	●	●	●
	14000	4.0	—	●	●	●	●	●
ASYG18/24LF	18000	5.0	—	—	—	●	●	●
	24000	7.0	—	—	—	●	●	●
AGYG09/12/14LV	9000	2.5	—	●	●	●	●	●
	12000	3.5	—	●	●	●	●	●
	14000	4.0	—	—	●	●	●	●
AUYG07/09/12/14/18LV	7000	2.0	—	●	●	●	●	●
	9000	2.5	—	●	●	●	●	●
	12000	3.5	—	●	●	●	●	●
	14000	4.0	—	—	●	●	●	●
ABYG14/18LV	18000	5.0	—	—	—	●	●	●
	14000	4.0	—	—	—	●	●	●
	18000	5.0	—	—	—	●	●	●
ARYG07/09/12/14/18LL	7000	2.0	—	●	●	●	●	●
	9000	2.5	—	●	●	●	●	●
	12000	3.5	—	●	●	●	●	●
	14000	4.0	—	—	●	●	●	●
	18000	5.0	—	—	—	●	●	●

## Indoor unit features

	Up/Down	Double	Adjust	Restart	Auto Changeover	HEAT	Fresh	Fresh	Economy	POWERFUL	Sleep	Program	Weekly	W+S	Filter	Ion	AF	Wash
ASYG07/09/12/14LM	●	●	●	●	●	●	●	●	●	●	●	●	●	●	○	●	●	●
ASYG07/09/12/14LU	●	●	●	●	●	●	●	●	●	●	●	●	●	●	○	●	●	●
ASYG18/24LF	●	●	●	●	●	●	●	●	●	●	●	●	●	●	○	●	●	●
AGYG09/12/14LV	●	●	●	●	●	●	●	●	●	●	●	●	●	●	○	●	●	●
AUYG07/09/12/14/18LV	●	●	●	●	●	●	○	○	●	●	●	●	●	●	○	●	●	●
ABYG14/18LV	○	●	●	●	●	●	○	○	●	●	●	●	●	●	○	●	●	●
ARYG07/09/12/14/18LL	○	○	●	●	●	○	○	○	●	●	○	○	●	●	●	●	●	●

○: Optional function

# 2 & 3-4 Rooms Multi

**2 Rooms :** AOYG14LAC2 / AOYG18LAC2

**3 Rooms :** AOYG18LAT3 / AOYG24LAT3

**4 Rooms :** AOYG30LAT4



## Features

### Space-saving installation

Multiple indoor units can be connected to 1 outdoor unit, and long piping connection is also possible. Compared with single type, the outdoor unit can be installed in various places to realize the space-saving installation.

Example:

Single type installation

Multi type installation

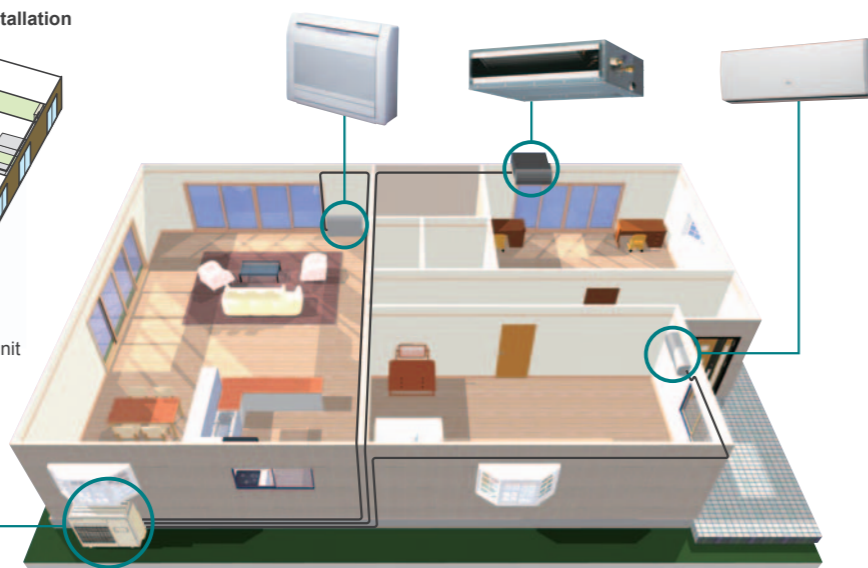
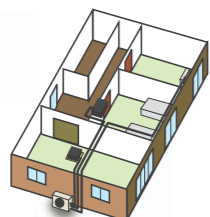
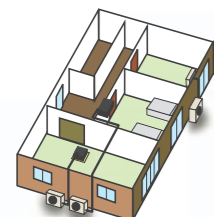

### Wide range of indoor units with various models

8 types 28 models are lined up in the capacity range from 2 kW to 7 kW class. Wide range of needs can be met from rooms of private homes to large shops and hotels.

### Flexible installation

Up to max. piping length of 70 m (AOYG30LAT4), max. height difference of 15 m can be supported. Multi type can be installed at large-size residence or buildings with multiple floors.

**Max. Piping Length (Each Unit):**  
**20 m** (AOYG14LAC2 / 18LAC2),  
**25 m** (AOYG18LAT3 / 24LAT3 / 30LAT4)

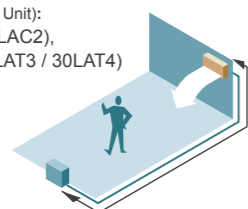

**Max. Height:**  
**15 m** (AOYG14LAC2 / 18LAC2 / 18LAT3 / 24LAT3 / 30LAT4)

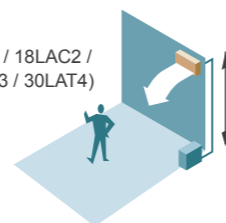

**Total Piping Length:**  
**30 m** (AOYG14LAC2 / 18LAC2),  
**50 m** (AOYG18LAT3 / 24LAT3),  
**70 m** (AOYG30LAT4)

### Specifications (2 ROOMS, 3 ROOMS, 4 ROOMS)

Model No.	Outdoor unit	AOYG14LAC2	AOYG18LAC2	AOYG18LAT3	AOYG24LAT3	AOYG30LAT4
Power Source	V/Ø/Hz	230/1/50	230/1/50	230/1/50	230/1/50	230/1/50
Rated Capacity (min-max)	Cooling	4.0 (1.4-4.4)	5.0 (1.7-5.6)	5.4 (1.8-6.8)	6.8 (1.8-8.5)	8.0 (3.5-10.1)
	Heating	4.4 (1.1-5.4)	5.6 (1.8-6.1)	6.8 (2.0-8.0)	8.0 (2.0-8.8)	9.6 (3.7-12.0)
EER	Cooling	3.67	3.21	4.00	3.51	3.60
COP	Heating	4.27	3.97	4.20	4.00	4.00
Sound Pressure (High)	Cooling	47	50	46	48	50
	Heating	49	51	47	49	51
Sound Power (High)	Cooling	61	63	65	68	68
	Heating	63	64	67	70	70
Net Dimension H x W x D	mm	540x790x290	540x790x290	700x900x330	700x900x330	830x900x330
Weight	kg(lbs)	37 (82)	38 (84)	55 (121)	55 (121)	68 (150)
Piping Connections	Small (Liquid)	Ø6.35x2	Ø6.35x2	Ø6.35x3	Ø6.35x3	Ø6.35x4 *(Ø6.35x3, Ø9.52)
	Large (Gas)	Ø9.52x2	Ø9.52x2 *(Ø9.52, Ø12.7)	Ø9.52x2, Ø12.7 *(Ø9.52x3)	Ø9.52x2, Ø12.7 *(Ø9.52x3)	Ø9.52x2, Ø12.7x2 *(Ø9.52x3, Ø12.7) *(Ø9.52x2, Ø12.7, Ø15.88)
Max. Length	Total / Each	30 / 20	30 / 20	50 / 25	50 / 25	70 / 25
Max. Height Difference	Between Outdoor Unit and Each Indoor Units.	15	15	15	15	15
	Between Indoor Units.	10	10	10	10	10
Operation Range	Cooling	10 to 46	10 to 46	-10 to 46	-10 to 46	0 to 46
	Heating	-15 to 24	-15 to 24	-15 to 24	-15 to 24	-10 to 24
Refrigerant		R410A	R410A	R410A	R410A	R410A

\* Connect to connection valve by the adapter.

### Dimensions

(Unit : mm)

Models : AOYG14LAC2 / AOYG18LAC2

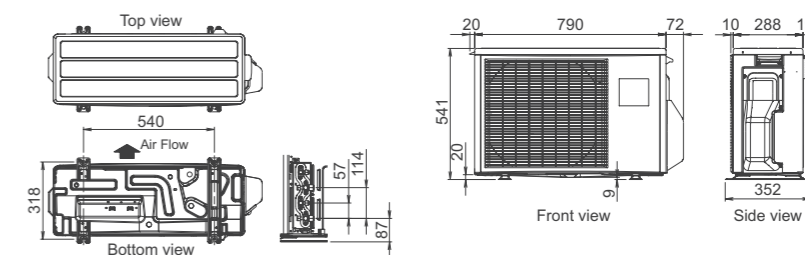

Models : AOYG18LAT3 / AOYG24LAT3

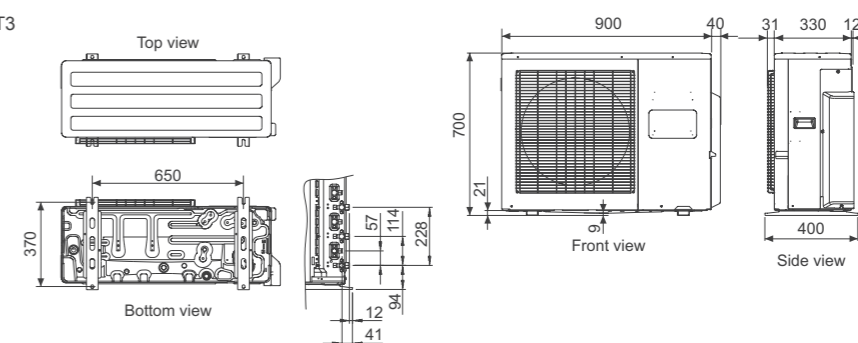

Models : AOYG30LAT4

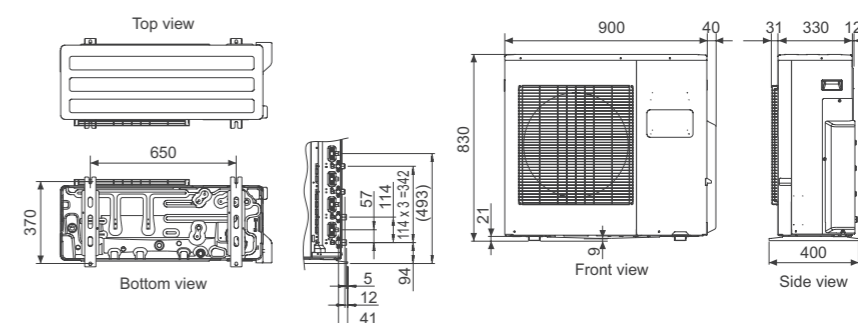

# 8 Rooms Multi

8 Rooms : AOYG45LBT8



## Features

### High Efficiency & Compact

#### Compact outdoor unit

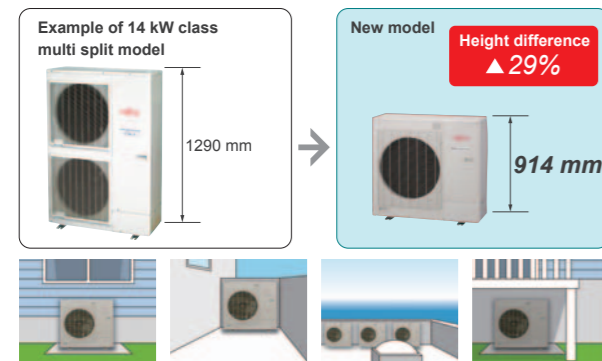

#### Innovated technology

- High efficiency large fan :** New high efficiency fan is mounted.
- DC fan motor :** High performance and high efficiency has been realized by using a small DC fan motor.
- Heat exchanger :** Reduced compact size and energy saving has been realized by utilizing high density piping design and 3-Row heat exchanger.
- High efficiency DC twin rotary compressor :** A high performance, low noise, large capacity DC twin rotary compressor is used.

#### High seasonal efficiency

The actual performance is conducted under various outside temperatures depending on weather and seasons, furthermore, especially for multi system, not all the rooms are operated all the time. So over 90% of actual operation time, air conditioners are operated at partial capacity instead of rated capacity. Considering these, we focused on energy-saving performance which is based on actual use. Efficiency of part load performance was drastically improved by developing ALL DC and our own inverter system.

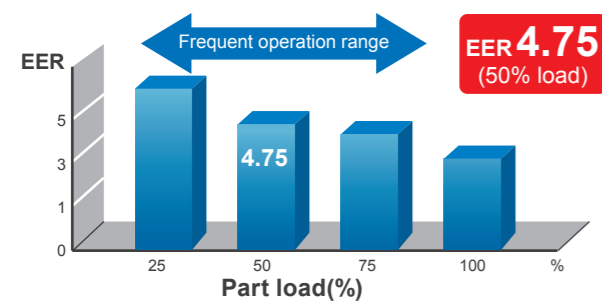

### More Comfort

#### Quick comfort by optimized refrigerant control

Every room meets the set point most quickly and comfortably by optimized refrigerant control.

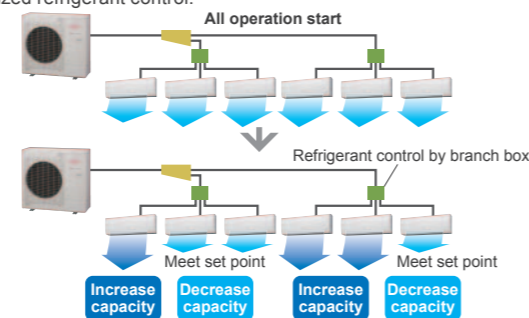

## Features

### Central Remote Controller Option

Central remote controller developed for residential applications. All indoor units can be batched controlled using simple operations. Schedule management and other functions can be used to achieve even greater energy savings.

#### Central & Individual Control

Batched control of up to 8 indoor units. The temperature, airflow volume, and remote control prohibition settings of all indoor units can be batched.

#### Easy-To-Use operation

- Large backlight LED screen
- Large easy-to-see operation panel



UTY-DMMYM

#### Multiple language support

Corresponds to 9 different languages (English, German, French, Spanish, Russian, Portuguese, Italian, Greek, and Turkish)

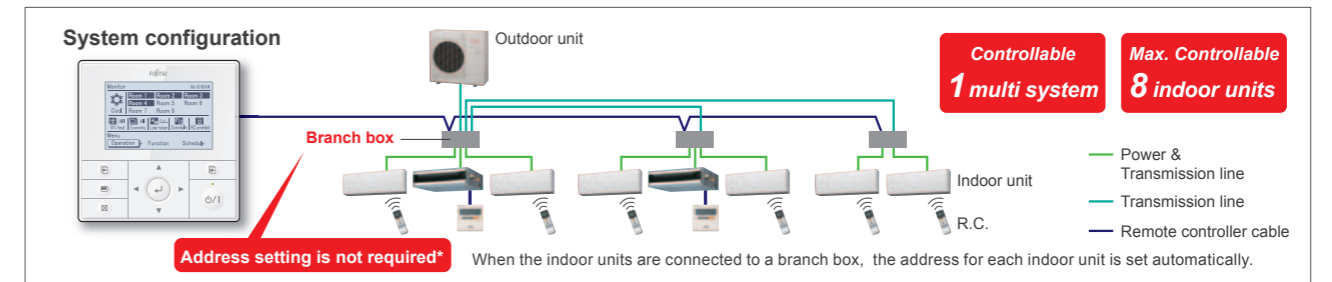

\*Note : Cross-over connections are not allowed in the refrigerant system. Group settings are not allowed.

#### 10°C heat operation

When you leave, minimum heating operation is performed to maintain the room temperature (maintain at 10°C).

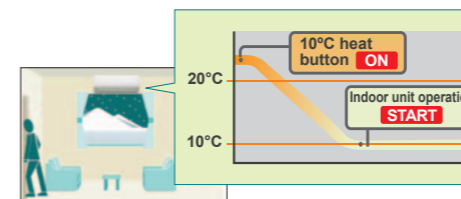

#### Economy operation

Economy operation is energy saving, as the set temperature of indoor unit is shifted by 1°C and the maximum electric value of the outdoor unit is suppressed.

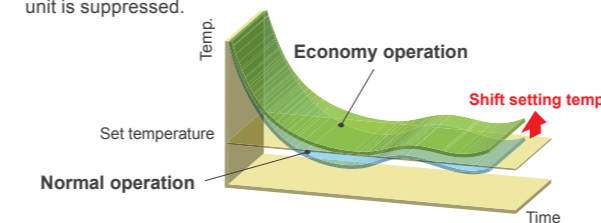

#### Prohibited Settings

The remote controller operation of all indoor units comes with a lock function to prevent unapproved operations in the various rooms. The central remote controller also has a key lock function to prevent children from playing with it, etc

#### Weekly schedule timer

The ON/OFF setting can be set for 4 times a day. Two weekly patterns can be set to match the cooling and heating seasons.

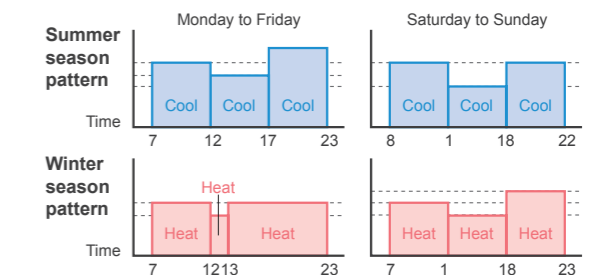

#### Low noise operation

Users can choose from 4 low noise levels, depending on the installation environment. The operation time can be set using the timer.

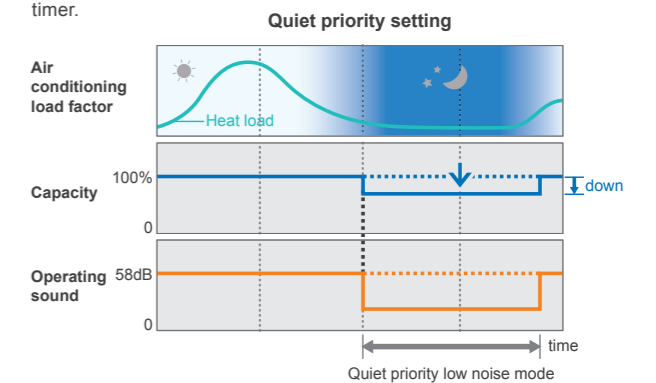

## Features

### Flexible Design & Easy Installation

#### Large capacity connection

Up to 8 indoor units can be connected to one outdoor unit.  
A maximum of 130% indoor unit connectable capacity. Match any room layout.

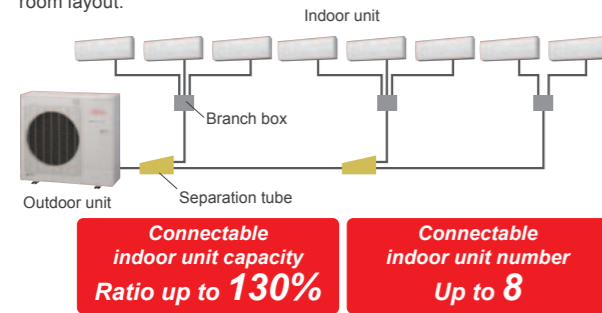

#### Long piping design

Can be installed in high rise condominiums or commercial buildings.

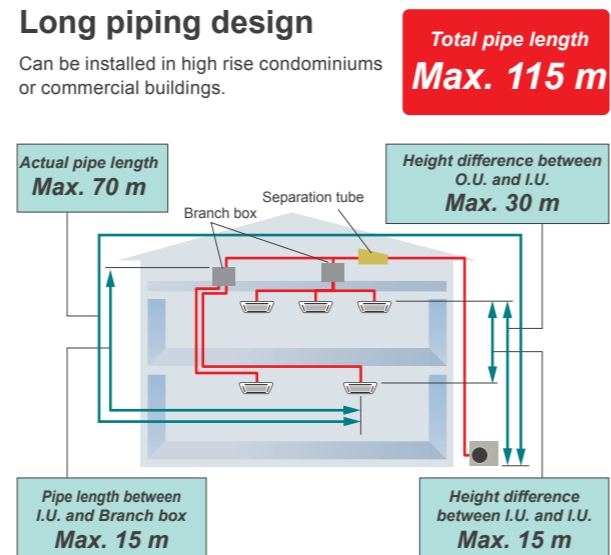

All flare piping connection and simple installation that minimizes wiring mistakes.

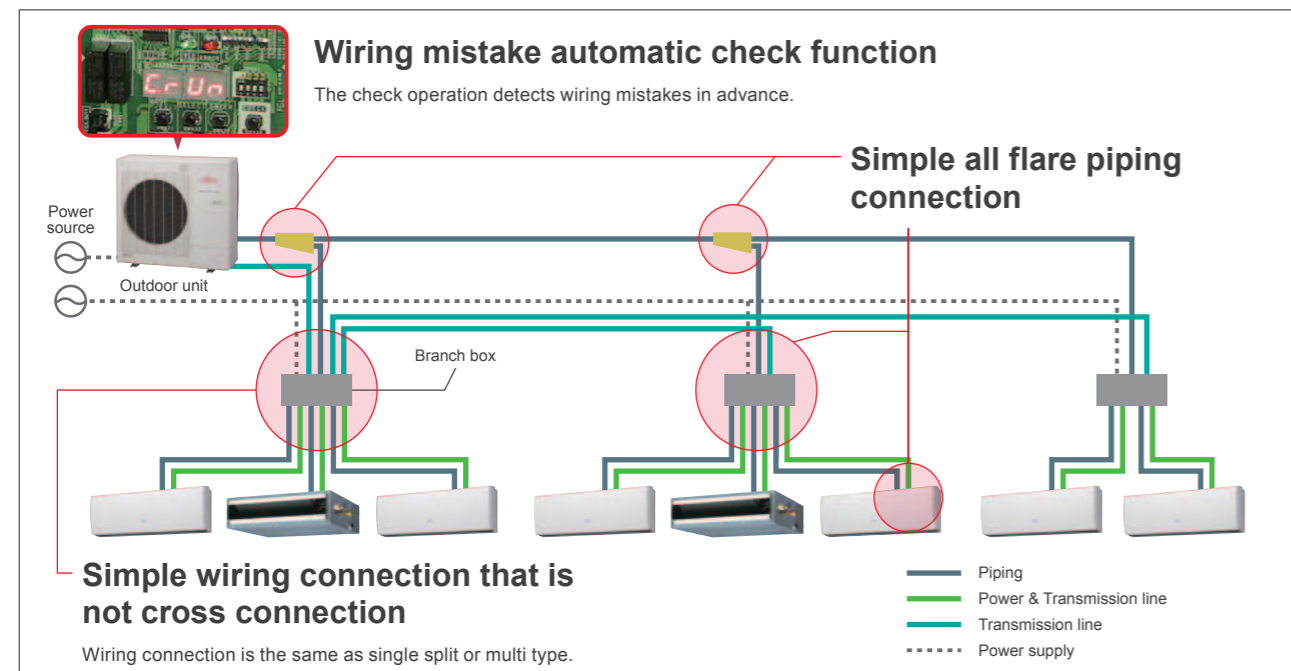

#### Branch Box can be mounted flexibly.

Allowed Branch Box Mounting Direction

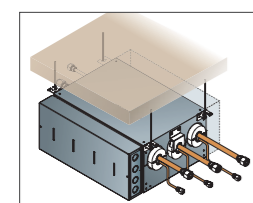

**Hanging from the ceiling**  
Do not hang from the ceiling when performing a vertical installation.

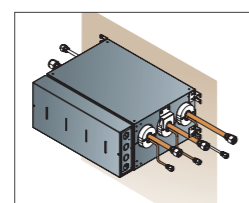

**Horizontal Wall Mounting**  
Install the unit with its top side facing upwards.

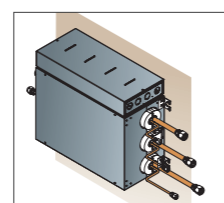

**Vertical Wall Mounting**  
Install the unit with the control box facing upwards.

## Specifications

Model name		AOYG45LBT8	
Maximum Connectable Indoor Unit		8	
Indoor unit connectable capacity	Cooling	kW	11.2 - 18.2
Power source	V/∅/Hz		230/1/50
Rated Capacity	Cooling	kW	14.0
	Heating	kW	16.0
Input Power	Cooling	kW	5.20
	Heating	kW	5.07
Air flow rate	Cooling	m <sup>3</sup> /h	4,650
	Heating	m <sup>3</sup> /h	4,800
Sound pressure level	Cooling	dB(A)	56
	Heating	dB(A)	58
Heat exchanger fin		Plate fin coil	
Net Dimensions H x W x D		914 x 970 x 370	
Weight		kg(lbs)	
		98 (217)	
Piping Connections (Small / Large)		mm	
		9.52/15.88	
Max Pipe Length		m	
		115 (Total)	
Max Height Difference (O.U. ~ I.U.)		m	
		30	
Operating range	Cooling	°CDB	-5 to 46
	Heating	°CDB	-15 to 24
Refrigerant		R410A	

Model name		UTP-PY03A		UTP-PY02A	
Connectable indoor unit		1 to 3 Units		1 to 2 Units	
Power source		V/∅/Hz		230/1/50	
Available voltage range		198-264V		198-264V	
Power consumption		W		10	
Running current		A		0.05	
Dimensions (HxWxD)		mm		195x433x370	
Weight		kg		9	
Connection pipe	Size	Liquid	mm		Main: 9.52x1, Branch: 6.35x3
		Gas	mm		Main: 15.88x1, Branch: 12.7x3
	Method			Flare	

Note: Specifications are based on the following conditions.  
Power source of specifications: 230V.

## Dimensions

(Unit : mm)

Outdoor Unit : AOYG45LBT8

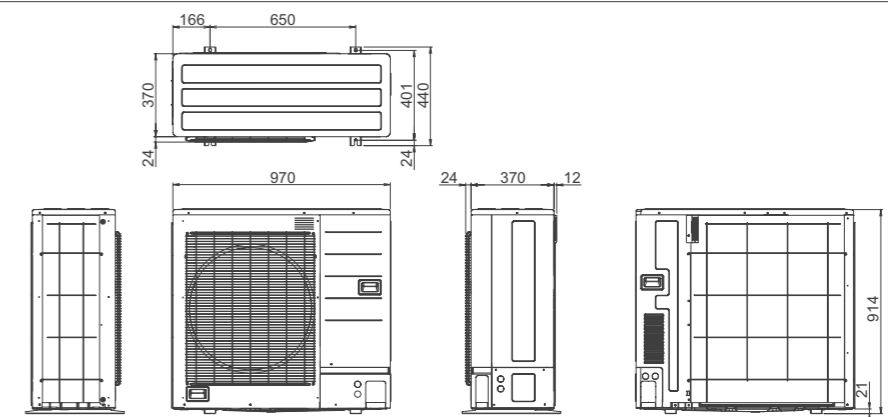

Branch Box : UTP-PY03A (3 branches type)

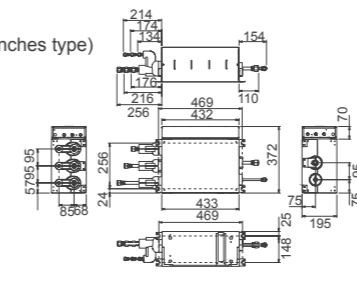

Branch Box : UTP-PY02A (2 branches type)

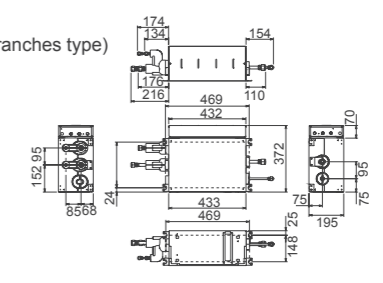

# Specifications of All Indoor Units

## Specifications

Compact wall mounted



Model No.	Indoor unit		ASYG07LUCA	ASYG09LUCA	ASYG12LUCA	ASYG14LUCA	
kW Class		kW	2.0	2.5	3.5	4.0	
Power Source		V/Ø/Hz	230/1/50	230/1/50	230/1/50	230/1/50	
Sound Pressure Level	Cooling	H/M/L/Q	dB(A)	35/30/28/21	36/32/28/21	37/34/31/21	41/36/33/25
	Heating			35/30/28/21	36/32/28/21	37/34/31/21	41/36/34/27
Sound Power Level	Cooling	H	dB(A)	53	54	55	59
	Heating			53	54	55	59
Air Flow	Cooling	H/M/L/Q	m³/h	570/520/470/330	600/550/470/330	660/600/530/330	710/640/570/390
	Heating			570/520/470/330	600/550/470/330	660/600/530/330	710/640/590/430
Net Dimension		mm	282x870x185	282x870x185	282x870x185	282x870x185	
Weight		kg(lbs)	9.5 (21)	9.5 (21)	9.5 (21)	9.5 (21)	
Pipe Size		Liquid/Gas	mm	Ø6.35/Ø9.52	Ø6.35/Ø9.52	Ø6.35/Ø12.7	

Wall mounted



Model No.	Indoor unit		ASYG07LMCA	ASYG09LMCA	ASYG12LMCA	ASYG14LMCA	ASYG18LFCA	ASYG24LFCC
kW Class		kW	2.0	2.5	3.5	4.0	5.0	7.0
Power Source		V/Ø/Hz	230/1/50	230/1/50	230/1/50	230/1/50	230/1/50	230/1/50
Sound Pressure Level	Cooling	H/M/L/Q	dB(A)	36/32/29/21	37/33/29/21	40/36/30/21	42/38/33/25	43/37/33/26
	Heating			36/32/29/22	37/33/29/22	40/36/31/22	42/38/35/27	42/37/33/25
Sound Power Level	Cooling	H	dB(A)	51	52	54	56	64
	Heating			51	52	55	57	58
Air Flow	Cooling	H/M/L/Q	m³/h	560/500/430/310	600/520/430/310	660/560/450/310	730/600/530/360	900/740/620/550
	Heating			560/500/430/330	600/520/430/330	660/560/470/330	730/615/560/375	900/740/620/550
Net Dimension		mm	268x840x203	268x840x203	268x840x203	268x840x203	320x998x238	320x998x238
Weight		kg(lbs)	8.5 (19)	8.5 (19)	8.5 (19)	8.5 (19)	14 (30.8)	14 (30.8)
Pipe Size		Liquid/Gas	mm	Ø6.35/Ø9.52	Ø6.35/Ø9.52	Ø6.35/Ø9.52	Ø6.35/Ø12.7	Ø6.35/Ø15.88

Floor



Model No.	Indoor unit		AGYG09LVCA	AGYG12LVCA	AGYG14LVCA	
kW Class		kW	2.5	3.5	4.0	
Power Source		V/Ø/Hz	230/1/50	230/1/50	230/1/50	
Sound Pressure Level	Cooling	H/M/L/Q	dB(A)	39/34/28/22	42/36/30/22	44/38/31/22
	Heating			39/35/30/22	42/38/32/22	44/39/33/22
Sound Power Level	Cooling	H	dB(A)	52	55	56
	Heating			52	55	56
Air Flow	Cooling	H/M/L/Q	m³/h	530/440/360/270	600/490/380/270	650/520/400/270
	Heating			530/460/380/270	600/510/410/270	650/540/430/270
Net Dimension		mm	600x740x200	600x740x200	600x740x200	
Weight		kg(lbs)	14 (30.7)	14 (30.7)	14 (30.7)	
Pipe Size		Liquid/Gas	mm	Ø6.35/Ø9.52	Ø6.35/Ø12.7	

Floor ceiling



Model No.	Indoor unit		ABYG14LVTA	ABYG18LVTB	
kW Class		kW	4.0	5.0	
Power Source		V/Ø/Hz	230/1/50	230/1/50	
Sound Pressure Level	Cooling	H/M/L/Q	dB(A)	36/34/33/29 (Under ceiling)	41/38/34/32 (Under ceiling)
	Heating			39/37/36/32 (Floor console)	44/41/37/35 (Floor console)
Sound Power Level	Cooling	H	dB(A)	36/34/33/29 (Under ceiling)	41/38/34/32 (Under ceiling)
	Heating			39/37/36/32 (Floor console)	44/41/37/35 (Floor console)
Air Flow	Cooling	H/M/L/Q	m³/h	51	55
	Heating			51	55
Net Dimension		mm	640/590/540/480	780/700/560/500	
Weight		kg(lbs)	640/590/540/480	780/700/560/500	
Pipe Size		Liquid/Gas	mm	199x990x655	Ø6.35/Ø12.7

Compact cassette



Model No.	Indoor unit		AUYG07LVLA	AUYG09LVLA	AUYG12LVLB	AUYG14LVLB	AUYG18LVLB
kW Class		kW	2.0	2.5	3.5	4.0	5.0
Power Source		V/Ø/Hz	230/1/50	230/1/50	230/1/50	230/1/50	230/1/50
Sound Pressure Level	Cooling	H/M/L/Q	dB(A)	33/31/29/27	33/31/29/27	37/33/31/28	40/35/32/29
	Heating			34/32/29/27	34/32/29/27	37/33/31/28	40/37/34/29
Sound Power Level	Cooling	H	dB(A)	46	46	49	52
	Heating			47	47	49	52
Air Flow	Cooling	H/M/L/Q	m³/h	540/490/440/390	540/490/440/390	610/530/470/410	680/580/490/410
	Heating			540/490/440/390	540/490/440/390	610/530/470/410	700/620/550/430
Net Dimension		mm	245x570x570	245x570x570	245x570x570	245x570x570	245x570x570
Weight		kg(lbs)	15(33.1)	15 (33.1)	15 (33.1)	15 (33.1)	15 (33.1)
Cassette Grille			UTG-UFYD-W				
Pipe Size		Liquid/Gas	mm	Ø6.35/Ø9.52	Ø6.35/Ø9.52	Ø6.35/Ø9.52	Ø6.35/Ø12.7

Slim duct

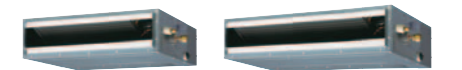

Model No.	Indoor unit		ARYG07LLTA	ARYG09LLTA	ARYG12LLTB	ARYG14LLTB	ARYG18LLTB
kW Class		kW	2.0	2.5	3.5	4.0	5.0
Power Source		V/Ø/Hz	230/1/50	230/1/50	230/1/50	230/1/50	230/1/50
Sound Pressure Level	Cooling	H/M/L/Q	dB(A)	28/26/25/24	28/27/26/25	29/28/27/26	32/30/28/26
	Heating			28/26/25/24	28/26/25/24	29/28/27/24	33/30/28/25
Sound Power Level	Cooling	H	dB(A)	57	57	58	60
	Heating			57	57	58	61
Air Flow	Cooling	H/M/L/Q	m³/h	550/490/470/440	600/550/500/450	650/600/550/480	800/700/600/480
	Heating			550/490/470/440	600/550/500/450	650/600/550/480	800/700/600/480
Net Dimension		mm	198x700x620	198x700x620	198x700x620	198x700x620	198x900x620
Weight		kg(lbs)	17 (37.5)	19 (41.8)	19 (41.8)	19 (41.8)	23 (50.6)
Pipe Size		Liquid/Gas	mm	Ø6.35/Ø9.52	Ø6.35/Ø9.52	Ø6.35/Ø9.52	Ø6.35/Ø12.7
External static pressure			0 to 90				
Drain pump			Standard				









# Multi Combination Table

## 8 Rooms Multi cooling

AOYG45LBT8	Combination of indoor unit							COOLING OPERATION										Input power
								Cooling Capacity									Total	
								Room 1	Room 2	Room 3	Room 4	Room 5	Room 6	Room 7	Room 8	KW		
	7	9	9	9	18	-	-	1.79	2.30	2.30	2.30	2.30	4.59	-	-	15.57	5.88	
6 Room	7	7	7	7	7	7	7	1.93	2.49	2.49	2.49	2.49	3.32	-	-	15.22	5.90	
7 Room	7	7	7	7	7	7	7	1.77	1.77	3.04	3.04	3.04	3.04	-	-	15.69	5.87	
8 Room	7	7	7	7	7	7	7	1.82	1.82	2.34	2.34	2.34	3.12	-	-	15.34	5.89	

Note: •Cooling capacity is based on 27°CDB/19°CWB(indoor temperature),35°CDB(outdoor temperature)  
 •Pipe Length: 5 m (Outdoor unit to Branch box), 3 m (Branch box to Indoor unit)  
 •Height difference: 0 m (Outdoor unit to Indoor unit)  
 •The values in this table should be used only as a guide. These values are calculated at standard conditions.  
 To fix your selection of models, select them according to "Model Selection" in the D&T manual.

## 8 Rooms Multi heating

AOYG45LBT8	Combination of indoor unit							HEATING OPERATION										Input power
								Heating Capacity									Total	
								Room 1	Room 2	Room 3	Room 4	Room 5	Room 6	Room 7	Room 8	KW		
	24	24	-	-	-	-	-	7.91	7.91	-	-	-	-	-	-	15.82	5.07	
2 Room	18	18	24	-	-	-	-	5.86	7.91	-	-	-	-	-	-	13.77	4.21	
3 Room	18	18	18	-	-	-	-	5.32	5.32	7.18	-	-	-	-	-	17.82	5.98	
4 Room	14	14	14	-	-	-	-	4.26	7.02	7.02	-	-	-	-	-	18.31	5.98	

Note: •Heating capacity is based on 20°CDB(indoor temperature),7°CDB/6°CWB(outdoor temperature)  
 •Pipe Length: 5 m (Outdoor unit to Branch box), 3 m (Branch box to Indoor unit)  
 •Height difference: 0 m (Outdoor unit to Indoor unit)  
 •The values in this table should be used only as a guide. These values are calculated at standard conditions.  
 To fix your selection of models, select them according to "Model Selection" in the D&T manual.  
 \*1:LMC type is not available for this combination.



# Simultaneous Multi Twin / Triple

**Model :** AOYG36LATT [3phase]  
 AOYG45LATT [3phase]  
 AOYG54LATT [3phase]



## Features

**Can support various installation scenes from office to commercial space by same place multi connection of up to 3 units.**

Indoor units distributed layout according to the shape and number of people and lighting conditions of the room even on wide floors and atypical floors. Ideal comfortable air flow distribution can be realized.

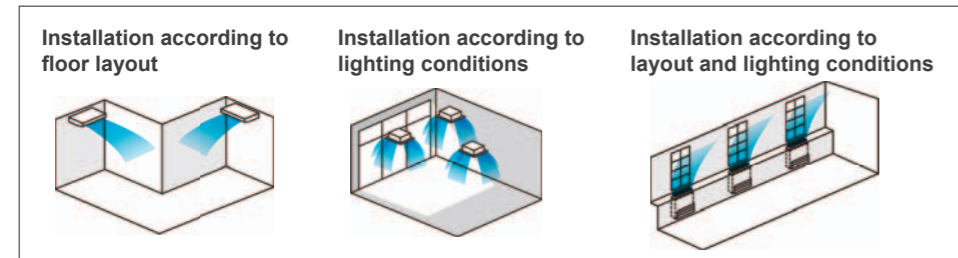

## Simultaneous Operation Multi type Indoor Unit Line up

	Twin			Triple
	18x2	22x2	24x2	18x3
<b>Cassette</b>	AUYG18LV×2 	AUYG22LV×2 	AUYG24LV×2 	AUYG18LV×3 
<b>Duct</b>	ARYG18LL×2 	ARYG22LM×2 	ARYG24LM×2 	ARYG18LL×3 
<b>Ceiling</b>	ABYG18LV×2 	ABYG22LV×2 	ABYG24LV×2 	ABYG18LV×3 
<b>Outdoor unit</b>	AOYG36LATT 	AOYG45LATT 	AOYG54LATT 	

Note: Combinations other than the above are not available.

## Features

### Simultaneous control

Max 16 indoor units are simultaneously controlled with a wired remote controller.

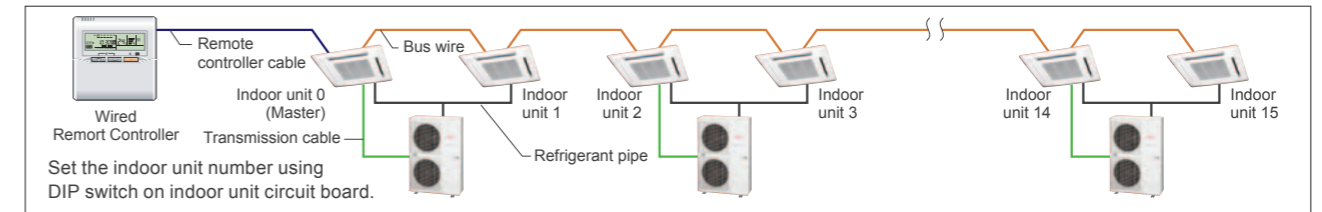

### Specifications

Model No.	Indoor unit	Compact Cassette			
		AUYG18LVLB	AUYG22LVLA	AUYG24LVLA	
Power Source	V/∅/Hz	230/1/50	230/1/50	230/1/50	
Air Flow (High)	Cooling H/M/L/Q	m³/h	680/580/490/410	930/830/600/450	930/830/600/450
Net Dimension H x W x D	mm	245x570x570	245x570x570	245x570x570	
Weight	kg(lbs)	15 (33)	16 (35)	16 (35)	
Cassette Grille		UTG-UFYD-W	UTG-UFYD-W	UTG-UFYD-W	

Model No.	Indoor unit	Duct			Floor/Ceiling Universal		
		ARYG18LLTB	ARYG22LMLA	ARYG24MLA	ABYG18LVTB	ABYG22LVTA	ABYG24LVTA
Power Source	V/∅/Hz	230/1/50	230/1/50	230/1/50	230/1/50	230/1/50	
Air Flow (High)	Cooling H/M/L/Q	m³/h	940/880/820/750	1100/910/750/580	780/700/560/500	980/820/680/540	
Net Dimension H x W x D	mm	198 x 900 x 620	270 x 1135 x 700	199 x 990 x 655	199 x 990 x 655	199 x 990 x 655	
Weight	kg(lbs)	23 (51)	38 (84)	27 (60)	27 (60)	27 (60)	

Model No.	Outdoor unit	AOYG36LATT			AOYG45LATT			AOYG54LATT		
		Capacity	Cooling	kW	10.0	12.5	14.0	12.5	14.5	16.0
	Heating	kW	11.2	14.5	16.0	12.5	14.5	16.0		
Power source	V/∅/Hz	400/3/50	400/3/50	400/3/50	400/3/50	400/3/50	400/3/50	400/3/50		
Pdesign	Cooling	kW	10.0	-	-	10.0	-	-		
	Heating (@-10°C)	kW	10.0	-	-	10.0	-	-		
SEER	Cooling	W/W	6.00	-	-	6.00	-	-		
SCOP	Heating	W/W	4.00	-	-	4.00	-	-		
Annual Energy Consumption	Cooling	kWh/a	583	-	-	583	-	-		
	Heating	kWh/a	3499	-	-	3499	-	-		
Energy Efficiency Class	Cooling		A+	-	-	A+	-	-		
	Heating		A+	-	-	A+	-	-		
Sound Pressure (High)	Cooling	dB(A)	51	54	55	51	54	55		
	Heating	dB(A)	67	-	-	67	-	-		
Net Dimension H x W x D	mm	1290x900x330	1290x900x330	1290x900x330	1290x900x330	1290x900x330	1290x900x330			
Weight	kg(lbs)	104 (229)	104 (229)	104 (229)	104 (229)	104 (229)	104 (229)			
Piping Connections (Small / Large)	mm	9.52/15.88	9.52/15.88	9.52/15.88	9.52/15.88	9.52/15.88	9.52/15.88			
Max Pipe Length (Pre-Charge)	m	75(30)	75(30)	75(30)	75(30)	75(30)	75(30)			
Height Difference	m	30	30	30	30	30	30			
Operation Range	Cooling	°CDB	-15 to 46	-15 to 46	-15 to 46	-15 to 46	-15 to 46			
	Heating	°CDB	-15 to 24	-15 to 24	-15 to 24	-15 to 24	-15 to 24			
Refrigerant		R410A	R410A	R410A	R410A	R410A	R410A			
Separation tube		UTP-SX236A (Twin)	UTP-SX254A (Twin)	UTP-SX254A (Twin) / UTP-SX354A (Triple)	UTP-SX254A (Twin)	UTP-SX254A (Twin) / UTP-SX354A (Triple)	UTP-SX254A (Twin) / UTP-SX354A (Triple)			

\*Different type and capacity indoor units can not be connected.

### Dimensions

(Unit : mm)

Outdoor Unit : AOYG36LATT / AOYG45LATT / AOYG54LATT

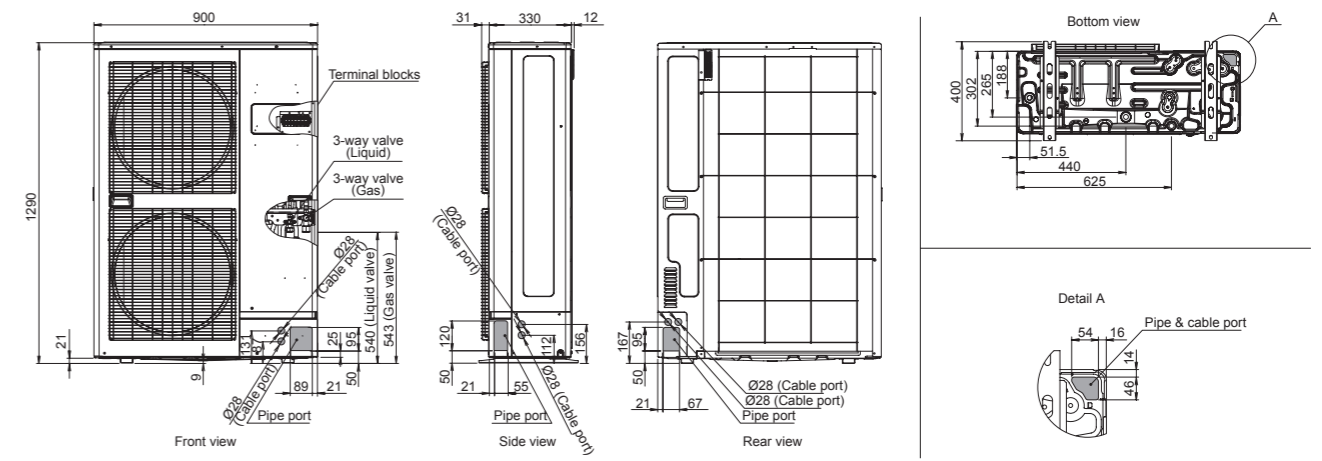

## Optional Parts List

Type	Wall Mounted						Duct						Cassette		Floor	Floor/Ceiling	Ceiling		
	Compact			Large			Slim	Medium static	High static			Compact	Large						
	ASVG 09/12 LTCA	ASVG 07/09/12/14 LUCA	ASVG 07/09/12/14 LMCA	ASVG 07/09/12 LLCC	ASVG 18LFC/24LFC	ASVG 30LFC	ARYG 07/09 LLTA/12/14 LLTB	ARYG 22/24/36/45LMLA/30/36 LMLE	ARYG 45/54 LHTA	ARYG60 LHTA	ARYC 72LHTA/90LHTA	AUYG 07/09 LVLA/12/14/18 LVLB	AUYG 22/24 LVLA	AUYG 30/36 LRL/36/45/54 LRLA	AGYG 09/12/14 LVCA	ABYG 14LVTA/18LVTB	ABYG 22LVTA/24LVTA	ABYG 30/36 LRTE/36/45/54 LRTA	
<b>Controllers</b>	<b>Wired Remote Controller</b>																		
	UTY-RVNYM			UTY-RVNYM			UTY-RVNYM			UTY-RVNYM		UTY-RVNYM		UTY-RVNYM		UTY-RVNYM		UTY-RVNYM	
	UTY-RNNYM			UTY-RNNYM			UTY-RNNYM			UTY-RNNYM		UTY-RNNYM		UTY-RNNYM		UTY-RNNYM		UTY-RNNYM	
	UTY-RSNYM			UTY-RSNYM			UTY-RSNYM			UTY-RSNYM		UTY-RSNYM		UTY-RSNYM		UTY-RSNYM		UTY-RSNYM	
<b>Simple Remote Controller</b>																			
<b>Central Remote Controller</b>																			
<b>IR Receiver Kit with Wireless Remote Controller</b>																			
<b>Remote Sensor Unit</b>																			
<b>Auto Louver Grille Kit</b>																			
<b>Long Life Filter</b>																			
<b>Flange</b>																			
<b>Drain Pump Unit</b>																			
<b>Wide Panel</b>																			
<b>Panel Spacer</b>																			
<b>Fresh Air Intake Kit</b>																			
<b>Air Outlet Shutter Plate</b>																			
<b>Insulation for High Humidity</b>																			
<b>Half Concealed Kit</b>																			
<b>Remote controller holder</b>																			

## Optional parts list (Communication devices)

Type	Indoor Unit												Outdoor Unit		
	Wall Mounted			Duct			Cassette		Floor	Floor/Ceiling	Ceiling	Single-phase	3-phase		
	Compact	Large		Slim	Medium static	High static	Compact	Large				Single Split	Single Split	Simultaneous Multi	
<b>Interface</b>															
<b>Wireless LAN Interface</b>	FJ-RC-WIFI-1														
<b>KNX® Interface</b>	FJ-RC-KNX-1i														
<b>MODBUS® Interface</b>	FJ-RC-MBS-1														
<b>Communication Kit</b>															
For Compact Wall Mounted	UTY-TWBXF			UTY-XCBXZ2											
For Indoor Unit*				UTY-XWZX		UTY-XWZX			UTY-XWZX		UTY-XWZX				
For Indoor Unit*	UTY-XWZXZ5														
<b>External Connect Kit</b>															
For Outdoor Unit															
For Outdoor Unit	UTY-XWZXZ3														
For Outdoor Unit	UTY-XWZXZ4														
For Outdoor Unit	UTY-XWZXZ4														
<b>External Control Set</b>															
For Indoor Unit (Duct type only) Use to connect with various peripheral devices and air conditioner PC board.				UTD-ECS5A			UTD-ECS5A				UTD-ECS5A				

\*Duct type is excluded.

## Refrigerant Piping Parts

### Connection Units

#### Separation Tube

UTP-SX236A / UTP-SX254A

For 3-phase simultaneous multi



UTP-SX354A

For 3-phase simultaneous multi



UTP-SX248A

For 8 Rooms Multi

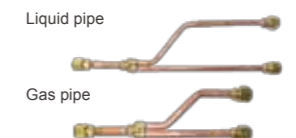

#### Branch Box

UTP-PY03A / UTP-PY02A

For 8 Rooms Multi



3 zones type



2 zones type

Max. controllable  
**16**  
Indoor units

## Wired Remote Controller : UTY-RVNYM

Hi-grade individual control using various functions.

- 3.7-inch LCD backlight screen.
- Supporting various Energy Saving functions with simple operation.
- Multiple Language Support.  
(English, German, French, Spanish, Russian, Portuguese, Italian, Greek, and Turkish)



## High performance and compact size

• In addition to the individual control, various energy saving controls can be realized using only one remote controller.



## Various energy saving function

### Auto OFF Timer

- The indoor unit automatically is turned off when it reaches the preset operating time frame.
- The time frame of the "Auto off timer" can be flexibly scheduled.
- Can be set off time 30 to 240 minutes

## Weekly Timer function

- Can be set up to 8 times per day (On/Off, mode, Temp)
- 2 pattern settings (i.e. Summer/Winter setting) are available.

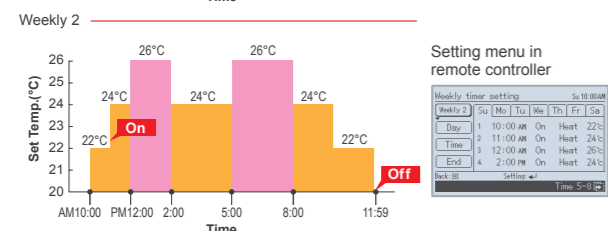
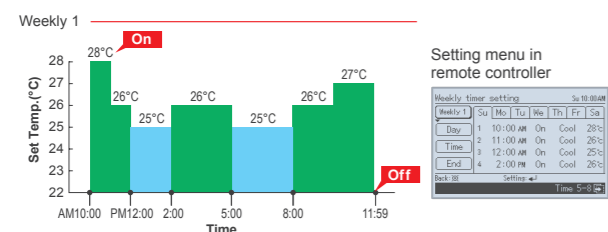

## High visibility and Easy operation

- Icon display of effectual functions.
- Main functions in large icons: "Mode", "Set Temp", and "Fan".
- Easy to operate by Control guide display.
- Simple operation with easy 4-way navigation pad.

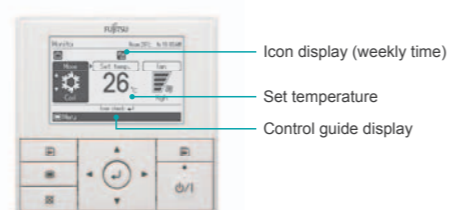

## Set Temperature Auto Return

- The setting temperature automatically returns to the previously set temperature.
- The time range in which the set temperature can be changed is 30 to 120 minutes.

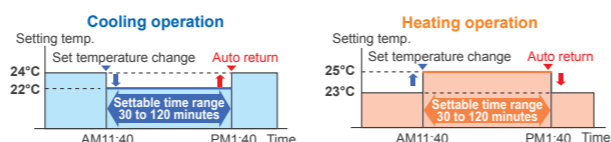

## Set Temperature Upper and Lower Limit Setting

- The set temperature range can be set for each operation mode. (Cooling / Heating / Auto)

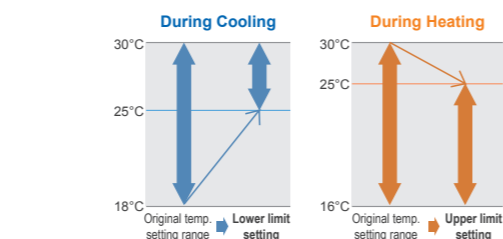

## Specifications

Model name	UTY-RVNYM
Power supply	DC 12 V
Dimension (H x W x D) (mm)	120 x 120 x 21.3
Weight (g)	220

\* DC12 V is supplied by indoor unit.

## Auto Louver Grille Kit : UTD-GXSA-W / UTD-GXSB-W / UTD-GXSC-W

Simple flat Auto Louver will provide comfort airflow and harmonize with luxury interior.



## Flexible Control

- **Operation with indoor unit**  
Auto Louver can be operated by synchronizing remote controller of indoor unit.
- **UP and Down auto swing**  
• Auto airflow direction and auto swing  
• 4 steps selectable
- **Auto-closing louver**  
When operation of indoor unit is stopped, the louver will automatically close.

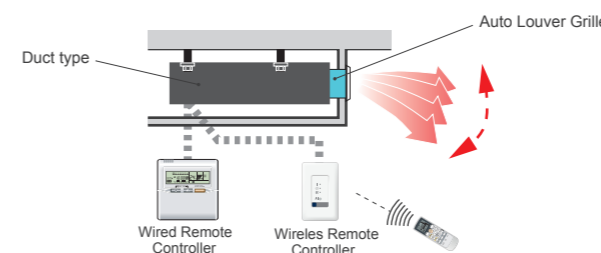

## Dimensions

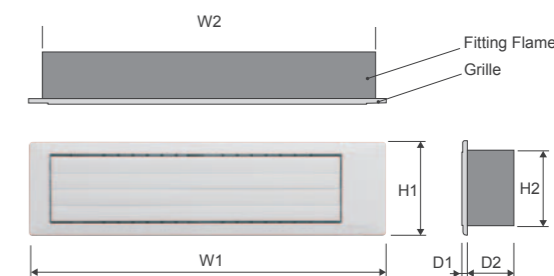

Model Name	W1	W2	H1	H2	D1	D2
UTD-GXSA-W	683	645	180	148	9	84
UTD-GXSB-W	883	845				
UTD-GXSC-W	1,083	1,045				

Unit: mm

## Specifications

Model name	UTD-GXSA-W	UTD-GXSB-W	UTD-GXSC-W
Applicable Indoor Unit	ARYG07/09LLTA ARYG12/14LLTB ARXD04/07/09/12/14GALH (For VRF)	ARYG18LLTB ARXD18GALH (For VRF)	ARXD24GALH (For VRF)
Power Supply	Connecting with Control box of indoor unit		
Fixing of Auto Louver Grille	Screw fixing to Flange or Square Duct		
Extension Square Duct Limit	1.0m (Max. duct length between indoor unit and Grille)		
Net Dimension (H x W x D)	mm (inch) 180x683x(84+9) [7-3/32x26-7/8x(3-5/16+11/32)]	180x883x(84+9) [7-3/32x34-3/4x(3-5/16+11/32)]	180x1083x(84+9) [7-3/32x42-5/8x(3-5/16+11/32)]
Weight	Net	kg (lb.)	2.0 (4.4)
	Gross	kg (lb.)	3.0 (6.7)
Color	White		
Louver Motor	Stepping Motor		
Accessories	Fitting Flame, etc.		
Operation range	Cooling	°C (°F)	18 to 32 (64 to 90)
	Heating	% RH	80% or less
		°C (°F)	16 to 30 (60 to 88)



## NEW Wireless LAN Interface : FJ-RC-WIFI-1



- It is the most advanced solution to remotely manage an Air Conditioning system using all sort of mobile devices such as Smartphones, Tablets and PC
- No separate external power supply required
- Can be used for single indoor units and group controlled (up to 16) indoor units

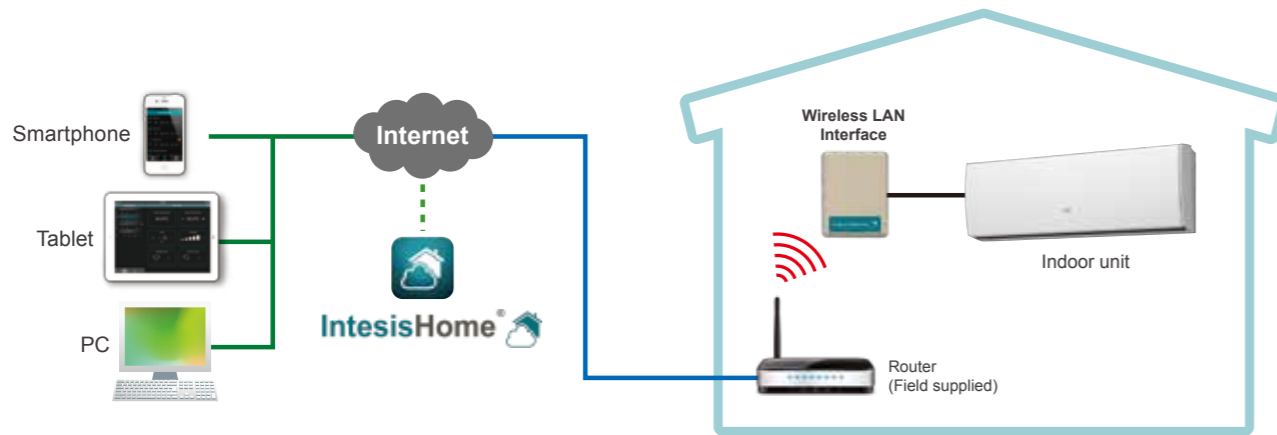

### Basic control

- Turning the units on and off
- Mode control (Heat, Cool, Dry, Auto, Fan)
- Fan speed setting
- Louver position (Airflow direction setting)
- Room temperature display
- Set temperature control
- Multi Language
- One Scene and Timer



(Application screen image)



### Advanced control (Optional functions)

- Climate working modes (ECO, Comfort, Powerful) (future release)
- Schedulable functionalities (ON/OFF, Modes, Set point temperature, Fan Speed, Louver position)
- Set temperature limitation (future release)
- Multiple Scenes & Timers and Calendar function

### Notifications and history

- Alerts e-mail notification (future release)
- Air conditioning malfunction alerts
- Connectivity monitoring and alerts
- History (future release)

### Specifications

Model name	FJ-RC-WIFI-1
Dimensions (H x W x D) (mm)	70×108×28
Weight (g)	80

## NEW KNX® Interface : FJ-RC-KNX-1i

The KNX Interface allows a complete integration of air conditioners with KNX Network systems.

- Simple installation due to small and compact size.
- No separate external power supply required (just KNX bus power).
- Can be used for single indoor units and group controlled (up to 16) indoor units.

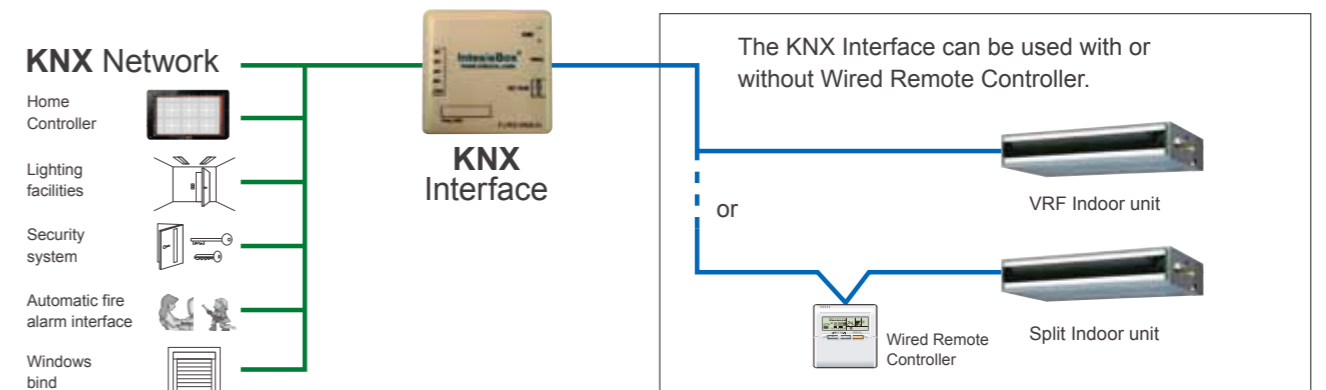

## NEW MODBUS® Interface : FJ-RC-MBS-1

The MODBUS Interface allows a complete integration of air conditioners into MODBUS Networks.

- Simple installation due to small and compact size.
- No separate external power supply required.
- The Modbus Interface permits central monitoring and control of air conditioners from BMS.

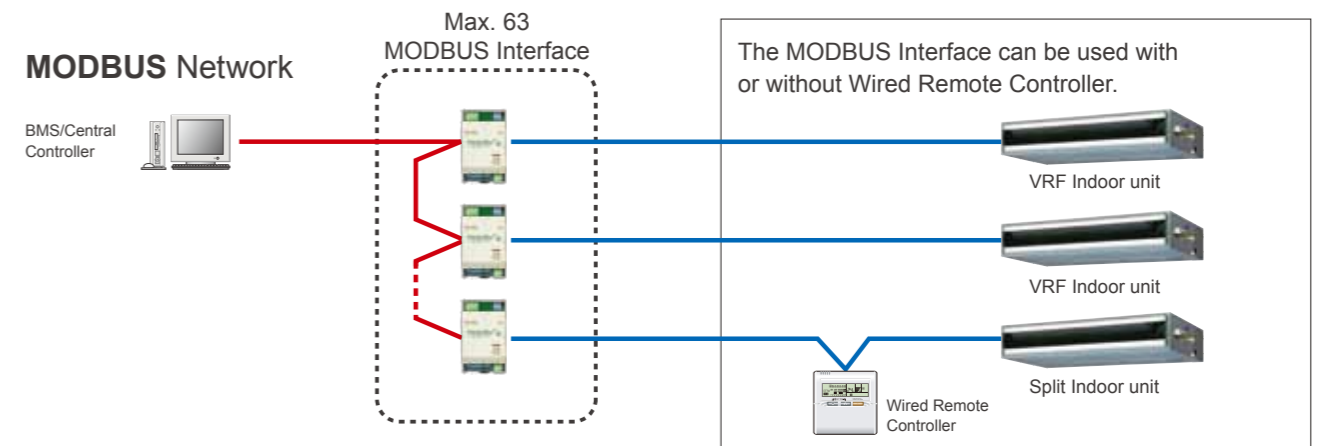



### Specifications

Model name	FJ-RC-MBS-1	FJ-RC-KNX-1i
Dimensions (H x W x D) (mm)	93×53×58	70×70×28
Weight (g)	85	70



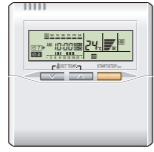

## Controllers

### For Individual & Centralized Control





<b>Wired Remote Controller</b> UTY-RVNYM 	<b>Wired Remote Controller</b> UTY-RNNYM 	<b>Simple Remote Controller</b> UTY-RSNYM 	<b>Central Remote Controller</b> UTY-DMMYM For 8 Rooms Multi 
--	--	--	---

## Communication devices

### Interface

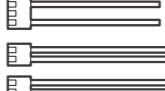
<b>Wireless LAN Interface</b> NEW FJ-RC-WIFI-1 	<b>KNX® Interface</b> NEW FJ-RC-KNX-11 	<b>MODBUS® Interface</b> NEW FJ-RC-MBS-1 	<b>Communication Kit</b> UTY-TWBXF / UTY-XCBXZ2 For Compact Wall Mounted type 
--	--	---	--

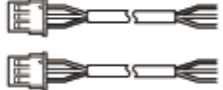
## External Connect Kit / External Control set

<b>External Connect Kit</b> For Indoor Unit  UTY-XWZX  UTY-XWZXZ5	<b>External Control Set</b> For Indoor Unit  UTD-ECS5A
<b>External Connect Kit</b> For Outdoor unit  UTY-XWZXZ2  UTY-XWZXZ3  UTY-XWZXZ4	

## Function list

		For Indoor unit			For Outdoor unit		
		UTY-XWZX	UTY-XWZXZ5	UTD-ECS5A	UTY-XWZXZ2	UTY-XWZXZ3	UTY-XWZXZ4
Input	Control	●	●	●	—	—	—
	Peak cut	—	—	—	●	●	—
	Low noise	—	—	—	●	●	—
	Priority	—	—	—	—	●	—
	Emergency stop	—	—	—	—	●	—
Output	Operation status	●	●	●	●	●	—
	Error status	—	●	●*1	●	●	—
	Fresh air control	—	—	●	—	—	—
	Auxiliary heater	—	—	●*2	—	—	—
	Preparation	—	—	●*2	—	—	—
	Base heater	—	—	—	—	—	●

\* 1 : Duct type does not have this function.







\* 2 : Cassette and Ceiling type does not have this function.

## Others

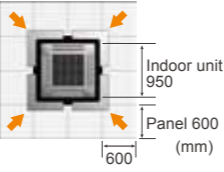

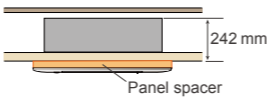
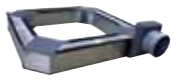
### For Duct type

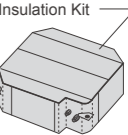
<b>Remote Sensor Unit</b> UTY-XSZX New amenity space can be offered by installing the Remote sensor. 	<b>IR Receiver Kit</b> UTY-LRHYM 	<b>Auto Louver Grille Kit</b> UTD-GXSA For 07 / 09 / 12 / 14 type UTD-GXSB For 18 type 	<b>Long-Life Filter</b> UTD-LF60KA UTD-LF25NA 
<b>Flange</b> UTD-RF204 (Round) UTD-SF045T (Square) 	<b>Drain Pump Unit</b> UTZ-PX1NBA For Medium Static Pressure Duct 		

### For Cassette type

<b>IR Receiver Kit</b> UTY-LRHYA2 	<b>Wide Panel</b> UTG-AGYA-W 	<b>Cassette Grille</b> UTG-UFYC-W For Compact Cassette type 	<b>Cassette Grille</b> UTG-UGYA-W 
<b>Panel Spacer</b> UTG-BGYA-W 	<b>Fresh Air Intake Kit</b> UTZ-VXAA For Compact Cassette type 	<b>Fresh Air Intake Kit</b> UTZ-VXGA 	<b>Insulation Kit For High Humidity</b> UTZ-KXGA / UTZ-KXGC For Compact Cassette type / Cassette type 
<b>Air Outlet Shutter Plate</b> UTR-YDZB For Compact Cassette type Shuts the air outlet when only using as 3 blow out. 	<b>Air Outlet Shutter Plate</b> UTR-YDZC Shuts the air outlet when only using as 3 blow out. 		

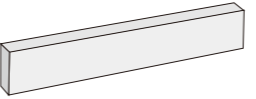
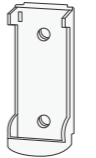
### For Floor type

<b>Half Concealed Kit</b> UTR-STA This kit is used to half conceal floor type indoor unit into the wall. 	<b>Remote Controller Holder</b> UTZ-RXLA For ASYG07 / 09 / 12LLCC 	<b>Drain Pump Unit</b> UTR-DPB24T 	<b>Service Monitoring Tool</b> NEW UTY-ASSX 
---	--	---	---



AIRSTAGE™ VRF Systems can be designed to create an air conditioning solution to suit most buildings requirements.

AIRSTAGE™ VRF Systems can be designed to effectively provide an air conditioning solution from a large domestic residence through to a large scale commercial building.



- 102** AIRSTAGE™ Outline
- 104** AIRSTAGE™ Features
- 110** AIRSTAGE™ J-IIS Heat pump type
- 114** AIRSTAGE™ J-II Heat pump type
- 118** AIRSTAGE™ V-II Heat pump type
- 126** AIRSTAGE™ VR-II Heat recovery type
- 134** AIRSTAGE™ Indoor Units
- 140** Controller
- 154** Adaptor & Convertor
- 160** Service & Maintenance
- 162** VENTILATION
- 168** Optional Parts for VRF

V R F



## Fujitsu General provides multi air conditioning systems for buildings AIRSTAGE™ Series matched to the size and application of the property

A pleasant air conditioned environment matched to the needs is created by combining a wide variety of outdoor units, indoor units, and controllers.



### Outdoor Units Line-up Page 110~

Heat Pump type for heating or cooling operation

**NEW**



Systems for large homes to medium sized offices, shops

4HP, 5HP, 6HP 3 models

**AIRSTAGE™ J-IIS**

Heat Pump type for heating or cooling operation



Systems for large homes to medium sized offices, shops

4HP, 5HP, 6HP 3 models

**AIRSTAGE™ J-II**

Heat Pump type for heating or cooling operation



Systems for large offices, hotels, and large composite facilities

8HP-48HP 33models

- Space saving combination : 8HP to 48HP / 21 models
- Energy efficiency combination : 16HP to 44HP / 12 models

**AIRSTAGE™ V-II**

Heat Recovery type for simultaneous heating and cooling operation



Systems compatible with individual operation mode control, as well as large offices, hotels, and large composite facilities

8HP-48HP 34models

- Space saving combination : 8HP to 48HP / 21 models
- Energy efficiency combination : 16HP to 44HP / 13 models

**AIRSTAGE™ VR-II**



### Indoor Units & Ventilations Line-up Page 134~

Capacity range 1.1 kW to 25.0 kW (J-II can be connected up to 14.0 kW.)

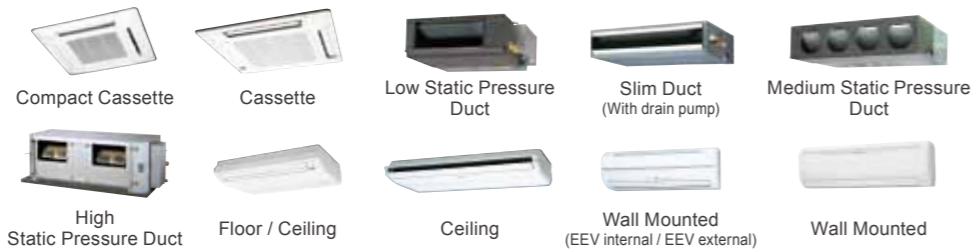

**NEW** Outdoor Air Unit 3 models Page 166~



### Various Easy-to-use Controllers Page 140~

User's needs are supported by offering a variety of controls, such as individual control, central control, and building management control options.



## Highly Energy Efficiency

Efficiency is improved significantly by using DC twin rotary compressor, inverter technology, and large heat exchanger

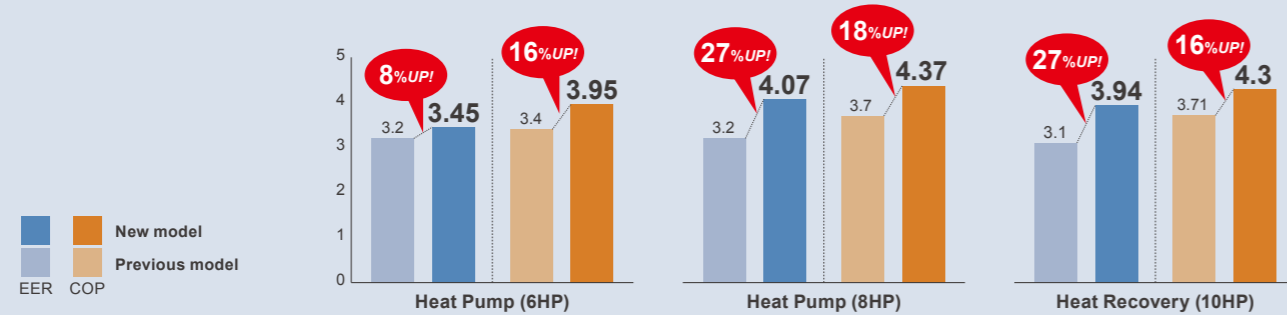

## Energy Saving Function

### Room temperature set point limitation

The minimum and maximum temperature ranges can be limited, which provide further energy saving while maintaining the comfort of the occupants.

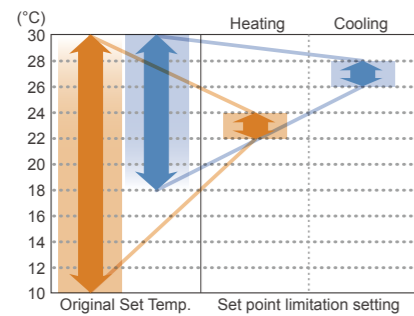

### Economy operation

Economy operation can be set by remote controller. The temperature setting is offset automatically over a certain period of time.

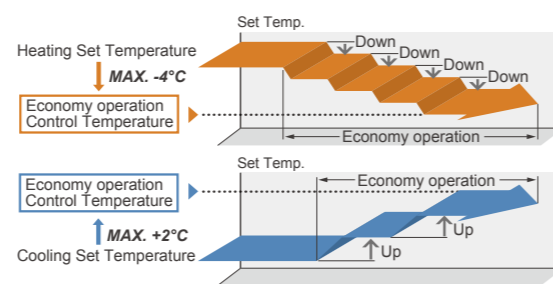

### Auto-off timer

- The indoor unit automatically is turned off when it reaches to the preset operating time frame.
- The time frame of the "Auto off timer" can be flexibly scheduled.

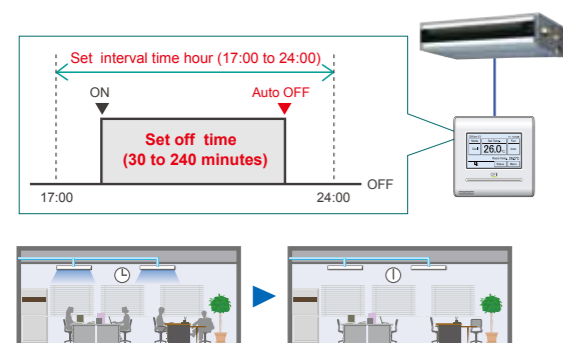

### Capacity save operation

Operation capacity can be set in 5 steps for rated capability. The power consumption at peak is cut down and the maximum load is suppressed.

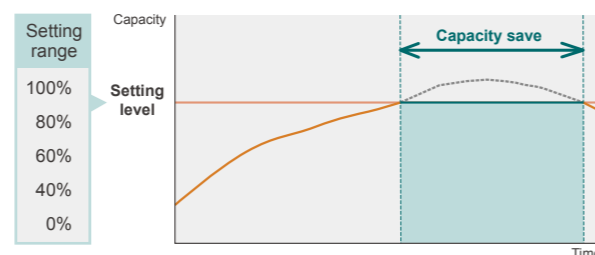

## More Comfort

### Precision refrigerant flow control

Precise and smooth refrigerant flow control is achieved by using a DC Inverter control in conjunction with individual indoor unit electronic expansion valve control. This allows high precision comfortable temperature control of  $\pm 0.5^\circ\text{C}$ .

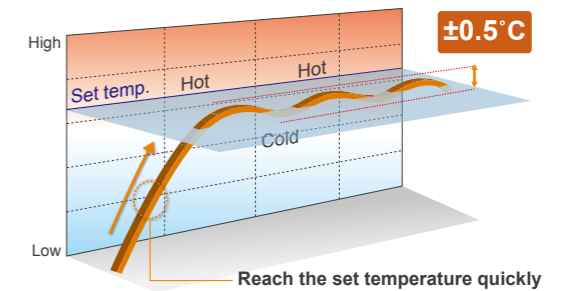

### Quiet operation

Two low noise modes can be selected automatically by quiet priority setting and capacity priority setting depending on the indoor environment and outside temperature load. This feature can be controlled via outdoor unit external input and/or system controller.

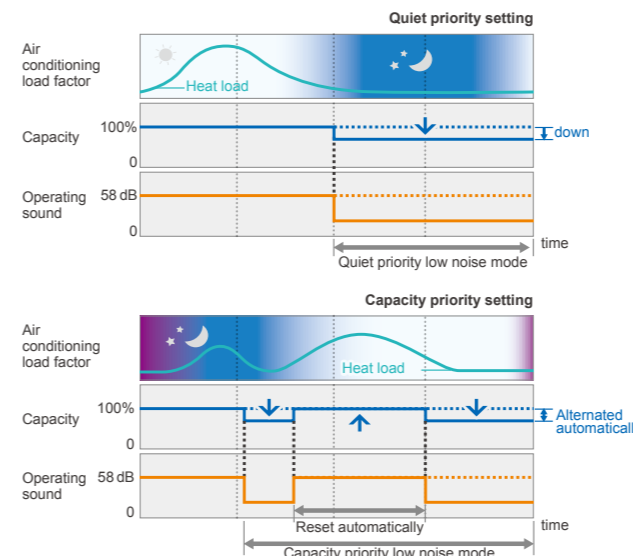

### Auto changeover function

At Auto setting, the cooling/heating mode is automatically switched according to the set temperature and room temperature.

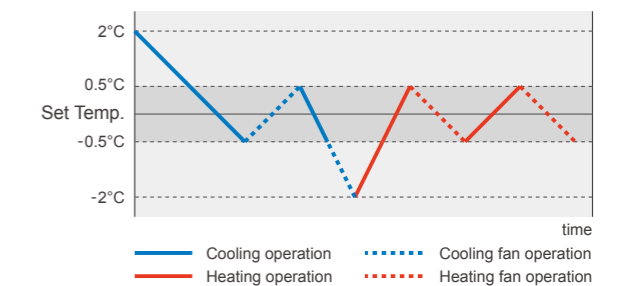

Suitable for especially Heat Recovery type

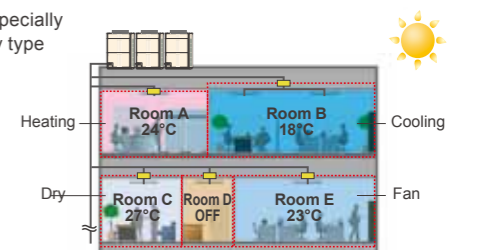

## Design Flexibility

### High capacity connection

#### 4HP-6HP

AIRSTAGE™ J-IIS series Heat Pump type

Connectable indoor unit capacity range  
**50% to 130%<sup>\*1</sup>**

Connectable indoor unit number  
**up to 8**



#### 4HP-6HP

AIRSTAGE™ J-II series Heat Pump type

Connectable indoor unit capacity range  
**50%<sup>\*2</sup> to 130%<sup>\*1</sup>**

Connectable indoor unit number  
**up to 9**



#### 8HP-48HP

AIRSTAGE™ V-II series Heat Pump type

Connectable indoor unit capacity range  
**50% to 150%<sup>\*1</sup>**

Connectable indoor unit number  
**up to 48**



AIRSTAGE™ VR-II series Heat Recovery type

Connectable indoor unit capacity range  
**50% to 150%<sup>\*1</sup>**

Connectable indoor unit number  
**up to 64**

\*1. Conditions of maximum connectable indoor unit capacity ratio is as the chart below.  
\*2. Only 4HP is 46%

Outdoor unit capacity	Maximum connectable indoor unit capacity ratio	
	Without 1.1 kW models	With 1.1 kW models <sup>*3</sup>
8HP-48HP	150%	130%
4HP-6HP	130%	120%

\*3. In the case of connectable indoor units, 1.1 kW models and Cassette and/or Duct type of 9.0 kW class or more, maximum connectable indoor unit capacity ratio is 110%.

### Wide operating range

Installation in extreme temperature conditions is possible due to an increase in operational range.

#### AIRSTAGE™ J-IIS series Heat Pump type

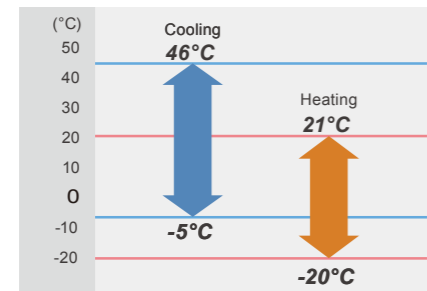

#### AIRSTAGE™ V-II series Heat Pump type

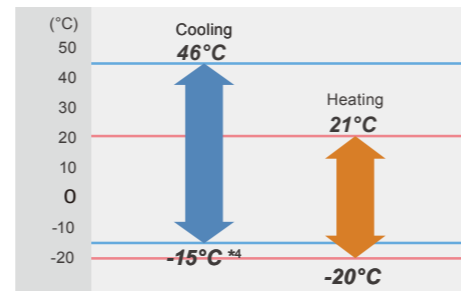

#### AIRSTAGE™ J-II series Heat Pump type

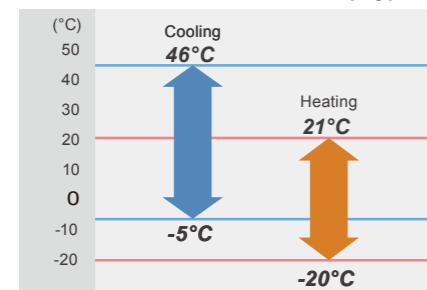

#### AIRSTAGE™ VR-II series Heat Recovery type

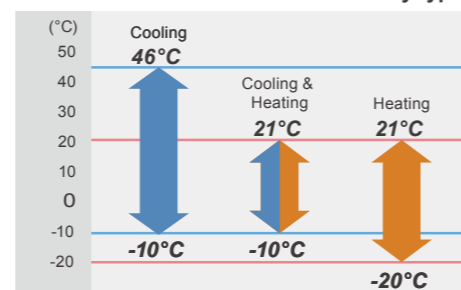

\*4. Note : When a multiple outdoor unit connection is used, operating range is from -5°C to 46°C in cooling.

## High Reliability

### Liquid flow back protection

By adopting a large sized accumulator, not completely vapourised refrigerant stays inside of the accumulator to ensure no liquid refrigerant is being fed into the compressor.

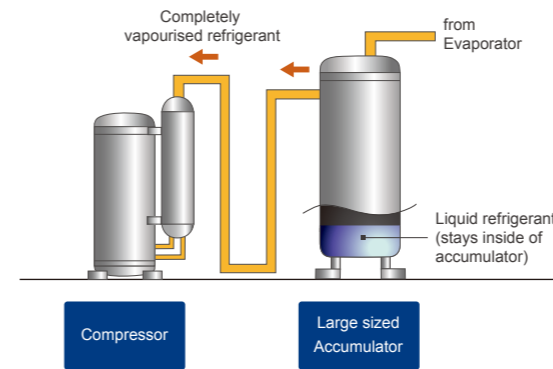

### Adoption of blue fin heat exchanger

Corrosion resistant of the heat exchanger has been improved by the introduction of blue fin treatment to the outdoor unit's heat exchanger.

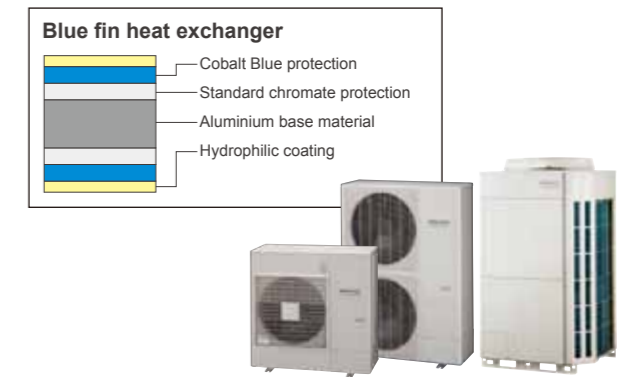

### Life-extending operation<sup>\*5</sup>

The compressor starting order is rotated so that the running time is shared.

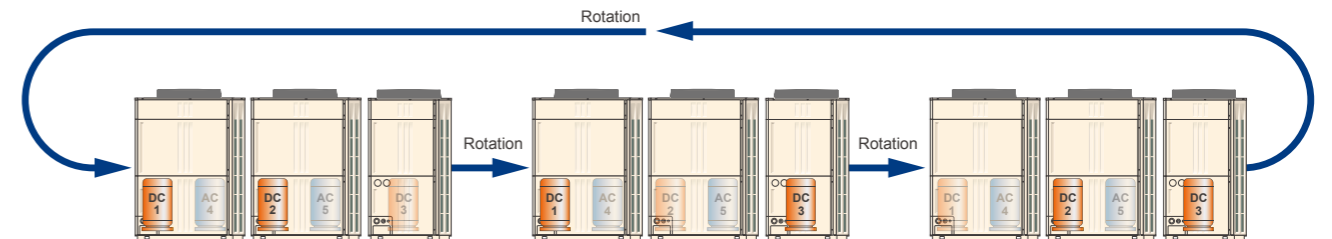

Note: The inverter compressors start in priority. Rotate operation is alternated by the start / stop timing of the compressors

### Backup operation<sup>\*5</sup>

If one compressor fails, backup operation will be performed by the remaining compressors\*.

\*.Note: Backup operation may not be possible depending on the trouble state.

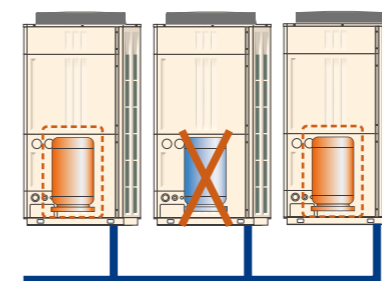

### Advanced refrigerant control<sup>\*5</sup>

Innovative compressor control logic has been introduced in order to balance the refrigerant mass flow rate of each outdoor unit by controlling the inverter speed.

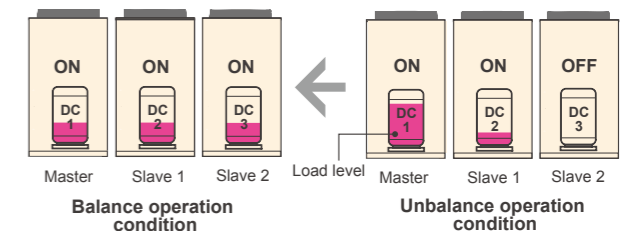

\*5. Not available for AIRSTAGE™ J-IIS and J-II series

## Easy Installation

### Easily transported

Easily craned using lifting belt hooks  
Design of outdoor unit allows for lifting straps to be used

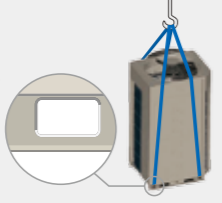

Transporting by forklift  
Transport with forklift is possible.

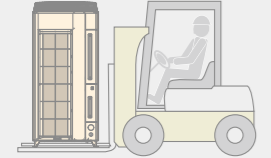

Can be transported in a small elevator



### Easy access

Reduced installation intervals by front access



Flexible installation by 4 way pipe direction



By adopting a L-Shape front panel that can be removed, the work space for installation and service has been significantly expanded by this new design.



For multiple installations, work is performed easily and efficiently even in a narrow space.

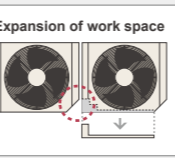

### Simple wiring work

Installation of the wiring systems is made easier as the communication wiring can be installed continuously between the indoor, outdoor and RB units.

Note: Serial connection can't use the automatic address setting in a multiple refrigerant system.

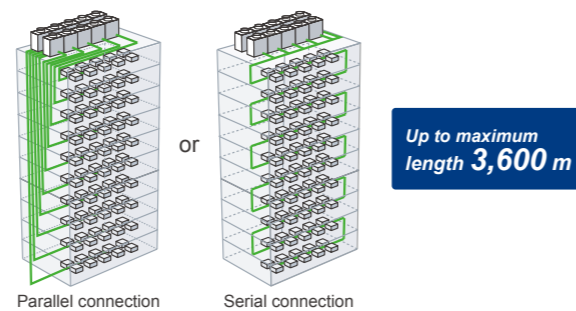

### Automatic address setting

The address of the indoor unit, RB unit and signal amplifier through the automatic function setting on the outdoor unit PCB.

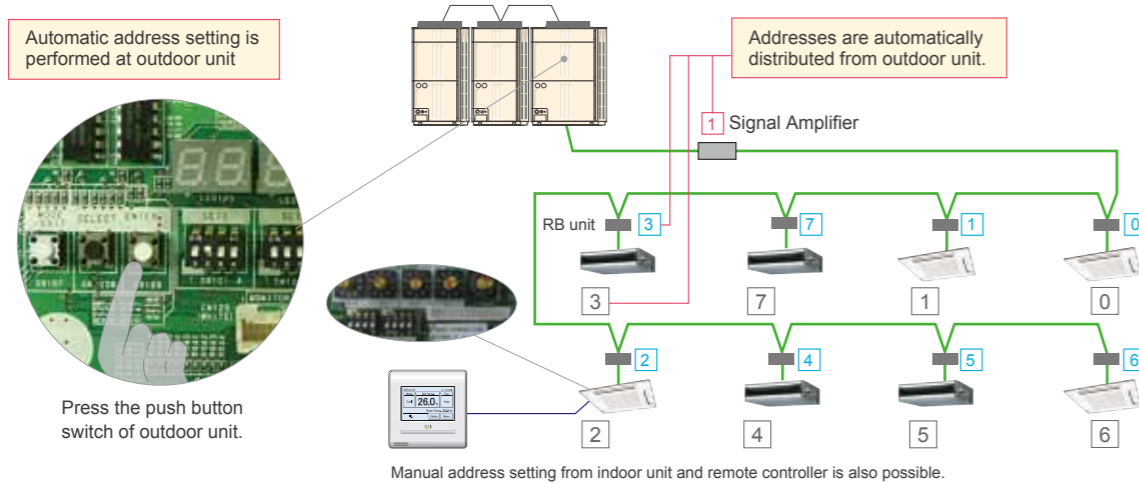

## Easy Service & Maintenance

### Design for easy maintenance

Movable PCB panel  
Easier for maintenance work behind the PCB



Easy to read 7-segment LED :  
Confirm detailed operational and error status without using any specific equipment.



7-segment LED

- Operation mode status
- Discharge temperature / Pressure status
- Compressor operation indication
- Address / type / number of outdoor unit

Error status can be checked easily via the indoor unit wired controller  
An error code is displayed on a liquid crystal screen.

Wired Remote Controller



System number  
001: Controller  
002: Indoor unit  
Error code  
Unit number

Simple Remote Controller



Remote controller address  
Error code

Wired Remote Controller (Touch panel)



Error status / Error history

No.	Date	Time	Address	Code
1	2007/11/11	11:58:08	000001	181
2	2007/11/25	11:58:08	000002	181
3	2007/11/25	11:58:08	000001	181
4	2007/11/25	11:58:08	000001	181
5	2007/11/25	11:58:08	000001	181
6	2007/11/25	11:58:08	000001	181

Error and quantity annunciation

Error code

Abnormal indoor unit address

- Error status can be checked easily by outdoor unit display

### Error diagnosis by Service Tool

**Connection to Service Tool**

- Detail operation status and recent error history can be checked and analyzed by using the Service Tool.
- Last 5 min. operation memory can be also recorded.

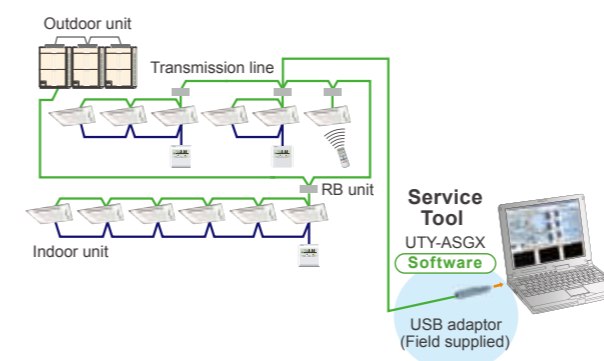

### Remote monitoring

The Web Monitoring system allows you to view system operation anytime over the internet, ensuring issue free operation.

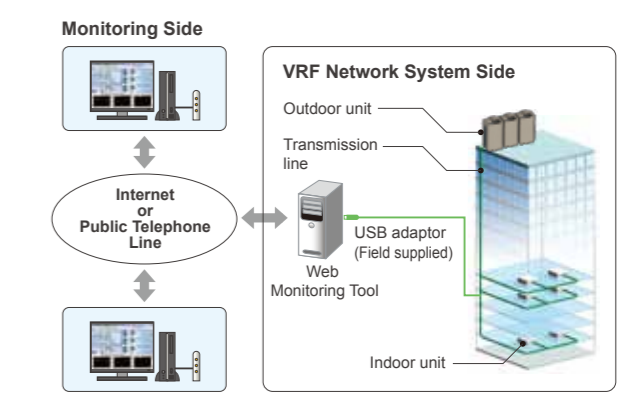

The operating VRF network system in the building can be monitored real time over the Internet.

**NEW Heat pump : AJY040LCLAH / AJY045LCLAH / AJY054LCLAH**

Fujitsu General provides air conditioning systems for a wide range of applications from small office buildings and stores to large houses.



**Features**

**It Can be Easily Carried and Installed Obscure Place**

Current model / 6HP class  
Height: 1334 mm  
Weight: 117 kg

**NEW Model / 6HP class**

Height difference  
**998 mm**  
▲ 25%

Light weight  
**87 kg**  
▲ 26%

**Small and light weight outdoor unit**

This model is much more compact than conventional 6HP comparable outdoor units. Even when installed on the balcony it fits within the height of the fence. The compact size with a height of less than 1 m allows it to be installed under windows and in tight spaces

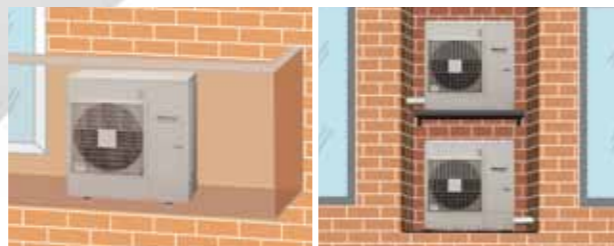

**Features**

**Low sound level design**

Significantly low sound level is improved by using DC twin rotary compressor, inverter technology, and advanced airflow structure design.

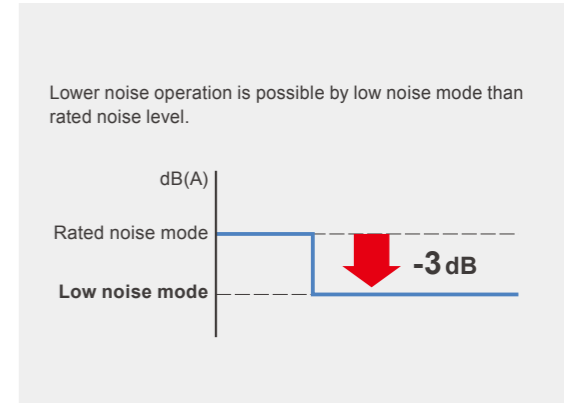
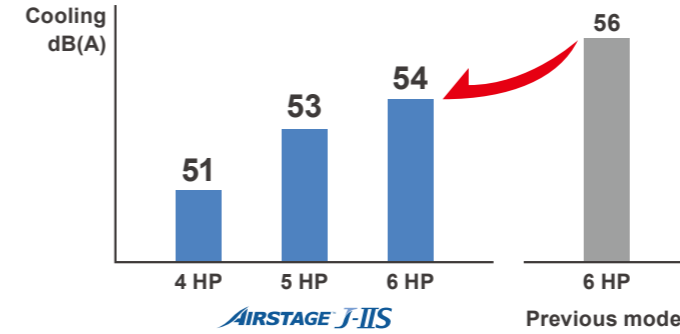

**Advanced high efficiency technology**

- Large propeller fan**  
High performance and low noise realized by large propeller and optimization of angle.
- DC fan motor**  
Miniaturized, low noise, high efficiency, multi-stage DC fan motor is mounted.
- DC inverter control**  
Efficiency is improved by mounting of new active filter module.
- Smooth airflow grille**  
This grille was aerodynamically designed for good efficiency with little blow loss.
- Compact and high performance DC twin rotary compressor**  
Efficiency in all load regions is good. Especially good performance from low to medium at normal operation.
- Low noise rubber**
- High efficiency compressor motor**
- Optimized refrigerant flow design**
- Highly accurate parts**
- Large heat exchanger**  
Heat exchange performance is substantially improved by mounting of 3-row large heat exchanger.
- High heat transfer copper tube (Improved lead angle)**

Compressor efficiency

Compressor capacity

100% High



Features

Long piping length

Our advanced refrigerant control technology allows us to achieve a total refrigerant piping length of 80 m. This opens up new possibilities in system design.

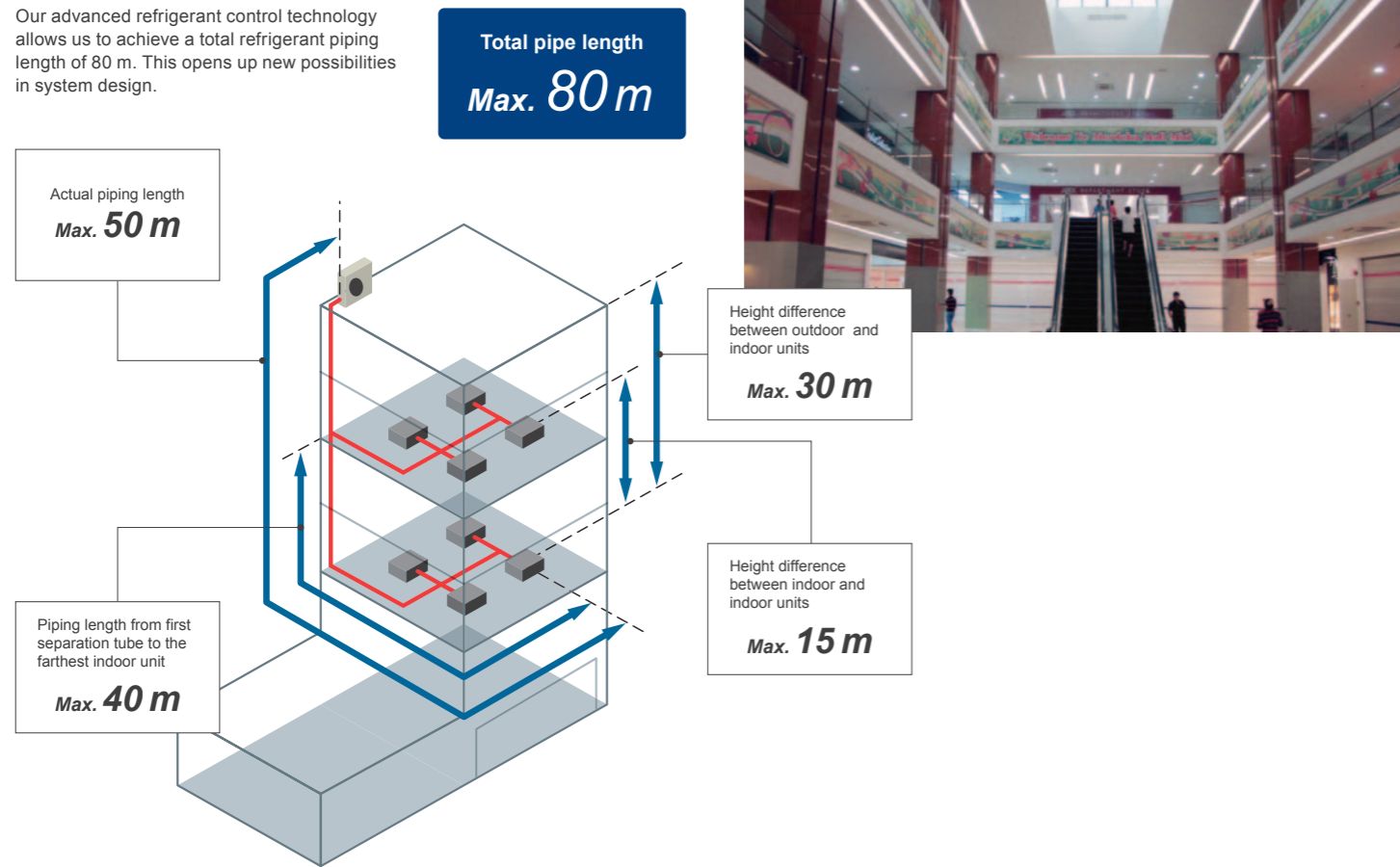

More Comfort

Non-stop oil recovery operation

A comfortable room condition is maintained during oil recovery mode because the product continues to operate without stopping the cooling or heating operation.

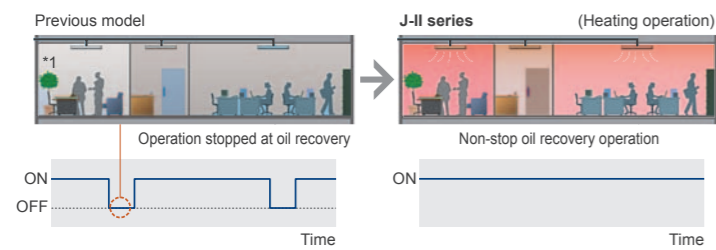

Easier Installation

**Connection check function** : Possible to confirm whether wiring connection and address setting are correct by a quick check run function.

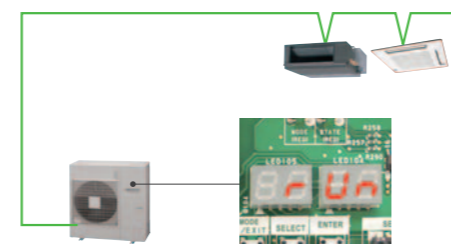

- Display connected indoor unit numbers
- Duplicately set address number of indoor unit can be displayed

Specifications

Rating capacity range	HP	4	5	6
Model name		AJY040LCLAH	AJY045LCLAH	AJY054LCLAH
Maximum connectable indoor unit		7	8	8
Power source	V/∅/Hz	230/1/50	230/1/50	230/1/50
Capacity	Cooling	12.1	14.0	15.1
	Heating	13.6	16.0	16.5
Input power	Cooling	3.44	4.43	5.32
	Heating	3.09	3.93	4.26
EER		3.52	3.16	2.84
COP		4.40	4.07	3.87
Airflow rate	m <sup>3</sup> /h	4,040	4,200	4,200
Sound Pressure level	Cooling	51	53	54
	Heating	54	55	56
Heat exchanger fin		Blue fin	Blue fin	Blue fin
Dimensions	Height	mm	998	998
	Width	mm	970	970
	Depth	mm	370	370
Weight	kg	86	86	87
Connection Pipe diameter	Liquid	mm	∅9.52	∅9.52
	Gas	mm	∅15.88	∅15.88
Total pipe length	m	80	80	80
Max. Height difference		30	30	30
Operation Range	Cooling	°C	-5 to 46	-5 to 46
	Heating		-20 to 21	-20 to 21

Note : Specifications are based on the following conditions.  
 Cooling : Indoor temperature of 27°CDB / 19°CWB, and outdoor temperature of 35°CDB / 24°CWB.  
 Heating : Indoor temperature of 20°CDB / (15°CWB), and outdoor temperature of 7°CDB / 6°CWB.  
 Pipe length : 7.5 m ; Height difference between outdoor unit and indoor unit : 0 m.  
 The protective function may work when using it outside the operation range.

Dimensions

(Unit : mm)

Model : AJY040LCLAH / AJY045LCLAH / AJY054LCLAH

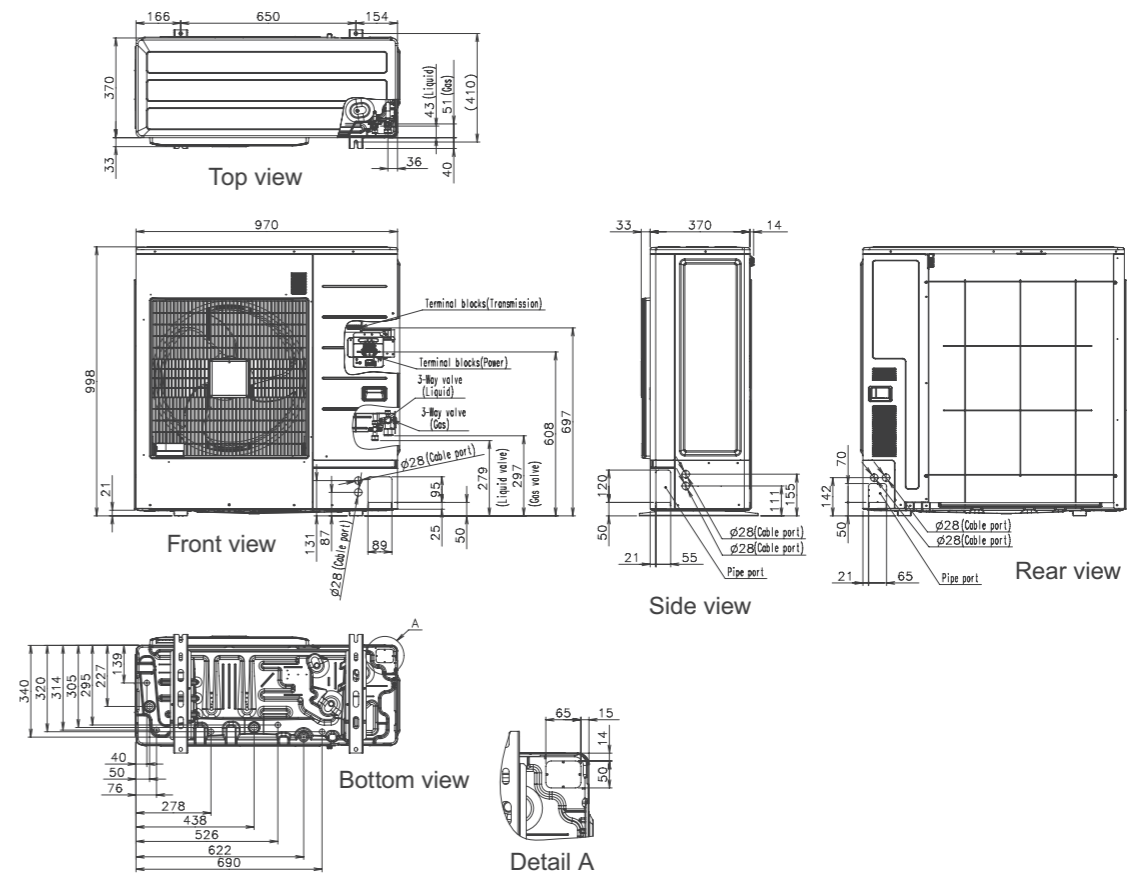

Heat pump : AJYA40LALH / AJYA45LALH / AJYA54LALH

Fujitsu General provides air conditioning systems for a wide range of applications from small office buildings and stores to large houses.



Features

The building load is in the range of 40 % to 80 %. Therefore, most air conditioners do not operate at maximum load, but operate at low to medium loads. Especially, for multi system, operation performance at partial load is important because air conditioners do not always operate at full load all the time. Aiming at energy saving performance matched to actual operation, Fujitsu General has developed a high performance air conditioner corresponding not only during the rated performance at 100 % load, but also at low to medium load

Load curve (a typical office building)

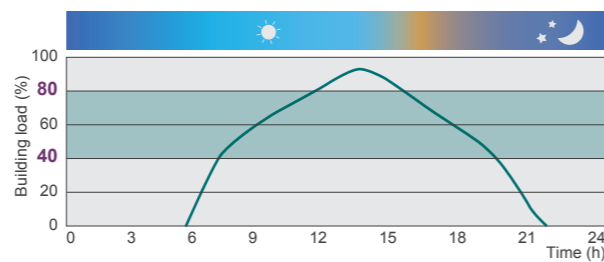

High EER / COP

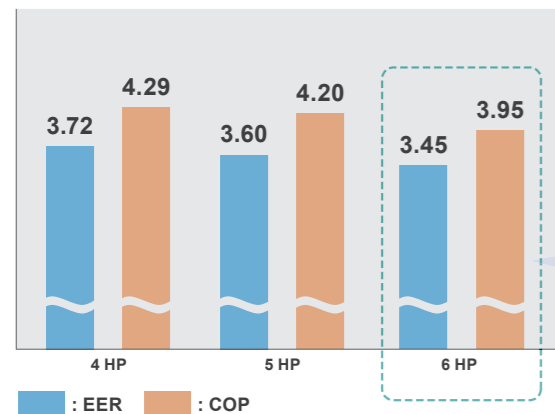

High part load performance (6HP class)

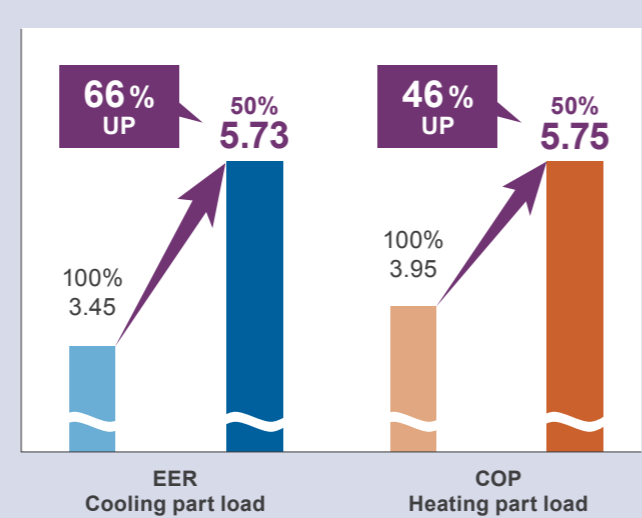

Conditions : Connected indoor units: AUXA30GALH+AUXD24GALH  
 Cooling : indoor temp. of 27°CDB / 19°CWB, outdoor temp. of 35°CDB / 24°CWB  
 Heating : indoor temp. of 20°CDB / 15°CWB, outdoor temp. of 7°CDB / 6°CWB

Features

Powerful Heating

Heating capacity is improved at low outdoor temperature by our advanced technology.

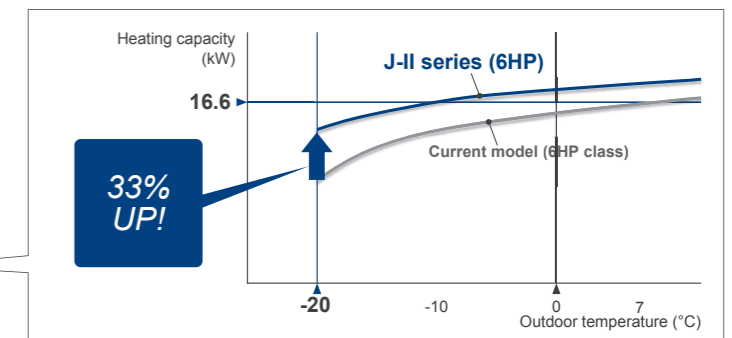

Advanced high efficiency technology



Large propeller fan

High performance and low noise realized by large propeller and optimization of angle.



DC fan motor

Miniaturized, low noise, high efficiency, multi-stage DC fan motor is mounted.

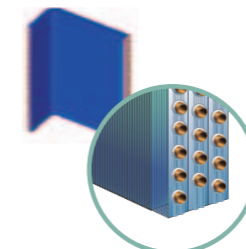

Large heat exchanger

Heat exchange performance is substantially improved by mounting of 3-row large heat exchanger.

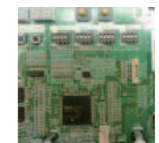

DC inverter control

Efficiency is improved by mounting of new active filter module.



Subcool heat exchanger

Cooling performance is improved by mounting of dual tube heat exchanger.

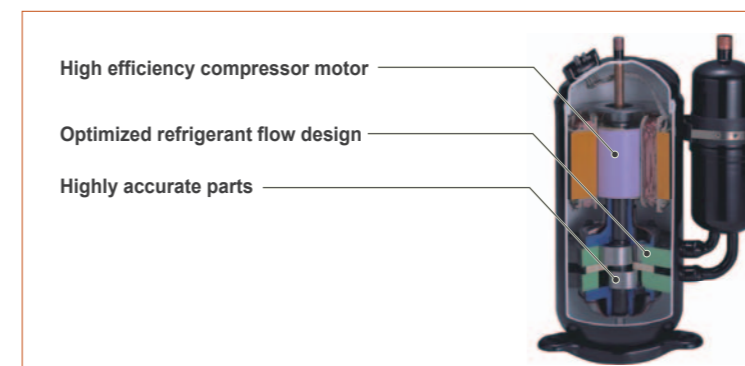
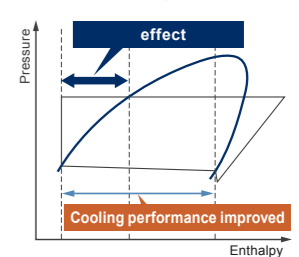

High efficiency compressor motor

Optimized refrigerant flow design

Highly accurate parts

DC twin rotary compressor

Efficiency in all load regions is good. Especially good performance from low to medium at normal operation.

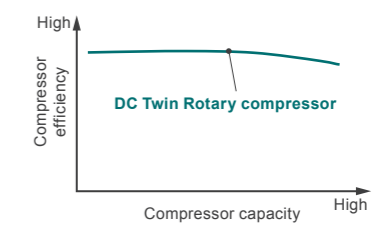

## Features

### Long Piping Length

Our advanced refrigerant control technology allows us to achieve a total refrigerant piping length of 180 m. This opens up new possibilities in system design.

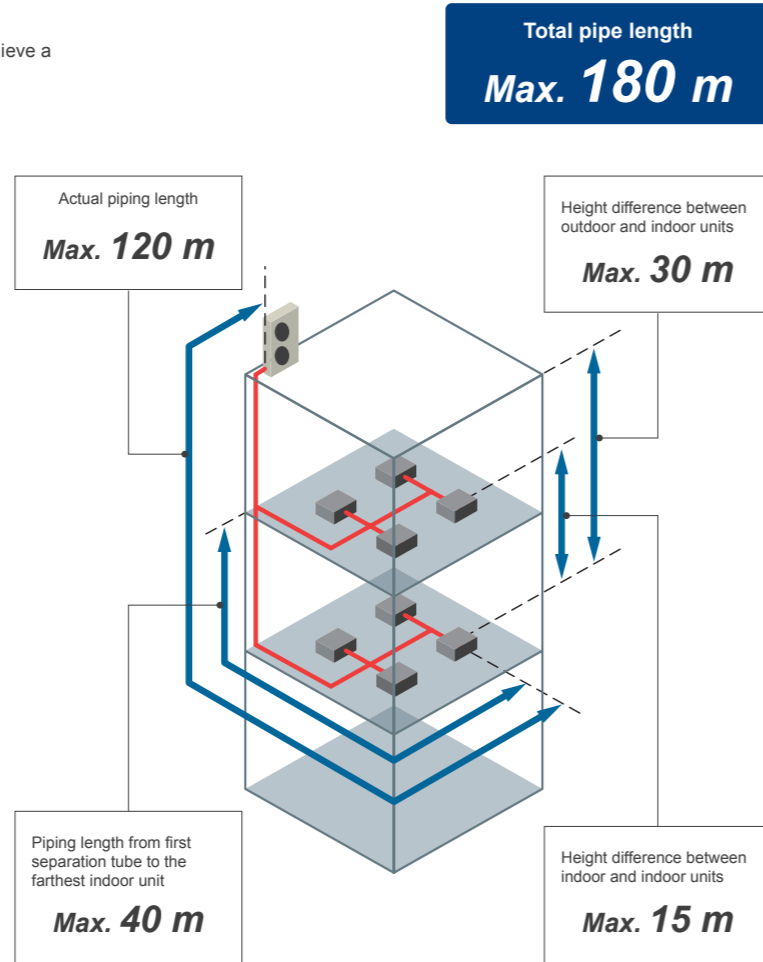

### More Comfort

#### Non-stop oil recovery operation

A comfortable room condition is maintained during oil recovery mode because the product continues to operate without stopping the cooling or heating operation.

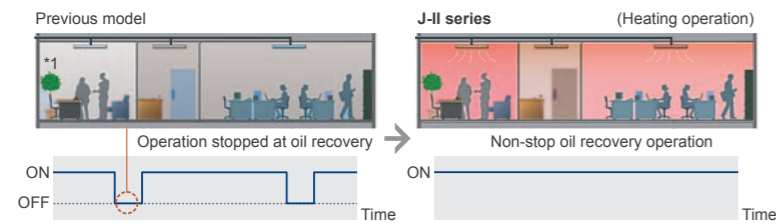

#### Easier Installation

**Connection check function:** Possible to confirm whether wiring connection and address setting are correct by a quick check run function.

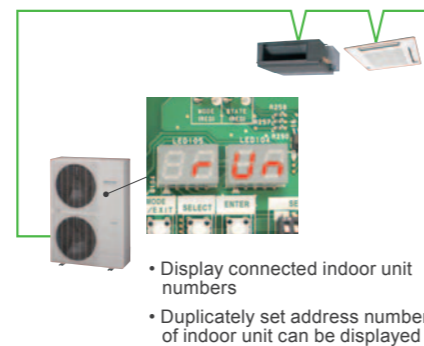

## Specifications

Rating Capacity range	HP	4	5	6	
Model name		AJYA40LALH	AJYA45LALH	AJYA54LALH	
Maximum Connectable Indoor Unit		7	8	9	
Power source	V/∅/Hz	230/1/50	230/1/50	230/1/50	
Capacity	Cooling	kW	12.1	14.0	15.5
	Heating	kW	13.6	16.0	18.0
Input power	Cooling	kW	3.25	3.89	4.49
	Heating	kW	3.17	3.81	4.56
EER	Cooling	W/W	3.72	3.60	3.45
COP	Heating	W/W	4.29	4.20	3.95
Air flow rate		m <sup>3</sup> /h	6,200	6,400	6,900
Sound pressure level	Cooling	dB (A)	50	51	53
	Heating	dB (A)	52	53	55
Heat exchanger fin		Blue fin	Blue fin	Blue fin	
Dimensions	Height	mm	1,334	1,334	1,334
	Width	mm	970	970	970
	Depth	mm	370	370	370
Weight		kg	117	117	117
Refrigerant charge		kg	4.8	5.3	5.3
Connection pipe diameter	Liquid	mm	∅9.52	∅9.52	∅9.52
	Gas	mm	∅15.88	∅15.88	∅19.05
Operation range	Cooling	°C	-5 to 46	-5 to 46	-5 to 46
	Heating	°C	-20 to 21	-20 to 21	-20 to 21

Note : Specifications are based on the following conditions.  
Cooling : Indoor temperature of 27°CDB / 19°CWB, and outdoor temperature of 35°CDB / 24°CWB.  
Heating : Indoor temperature of 20°CDB / (15°CWB), and outdoor temperature of 7°CDB / 6°CWB.  
Pipe length : 7.5 m; Height difference between outdoor unit and indoor unit : 0 m.  
The protective function may work when using it outside the operation range.

## Dimensions

(Unit : mm)

Model : AJYA40LALH / AJYA45LALH / AJYA54LALH

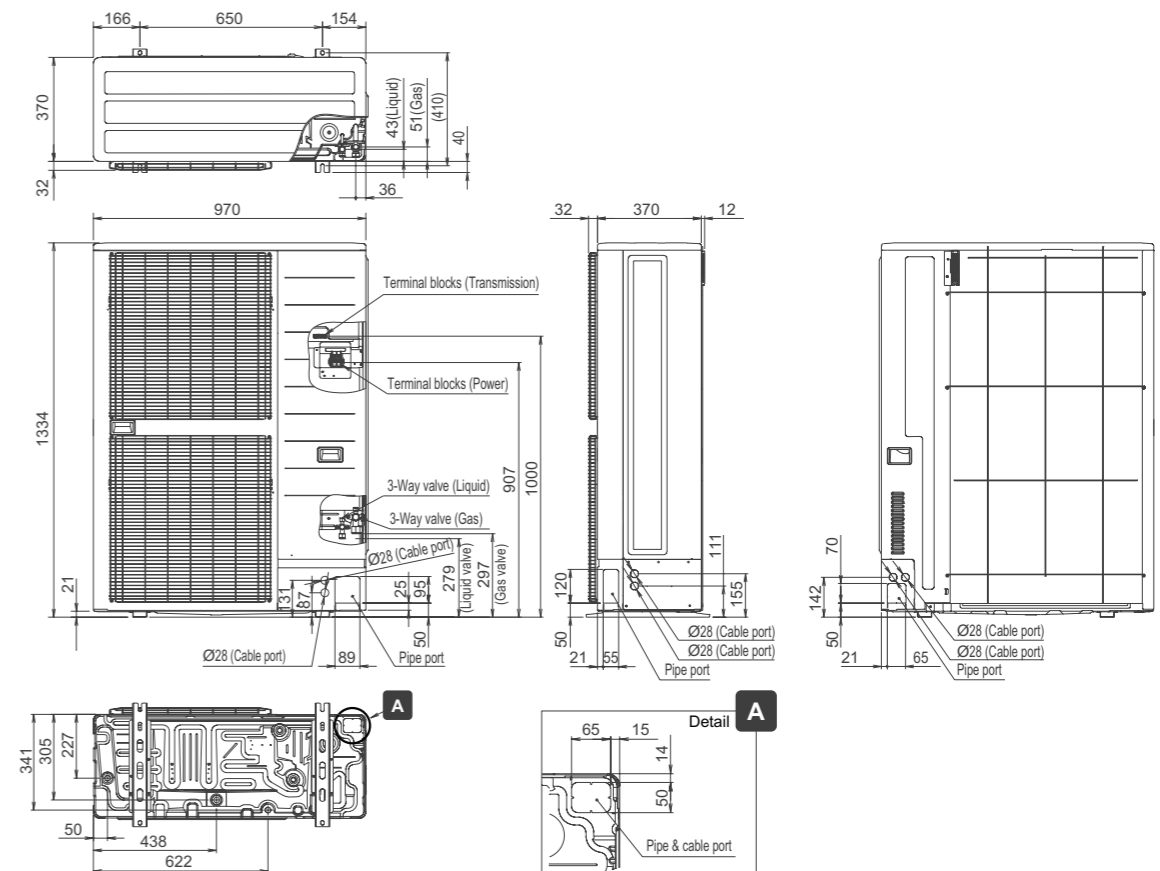

## Heat pump

Smart and cutting edge design  
 Extensive lineup from 8HP to 48HP in 2HP increment  
 Connectable indoor unit capacity ratio up to 150%



## Features

### Efficiency in actual operation

Top class high COP is realized for all combinations by our unique heat exchanger structure, high efficient DC twin compressor, and other our own technologies.

### Space saving combination

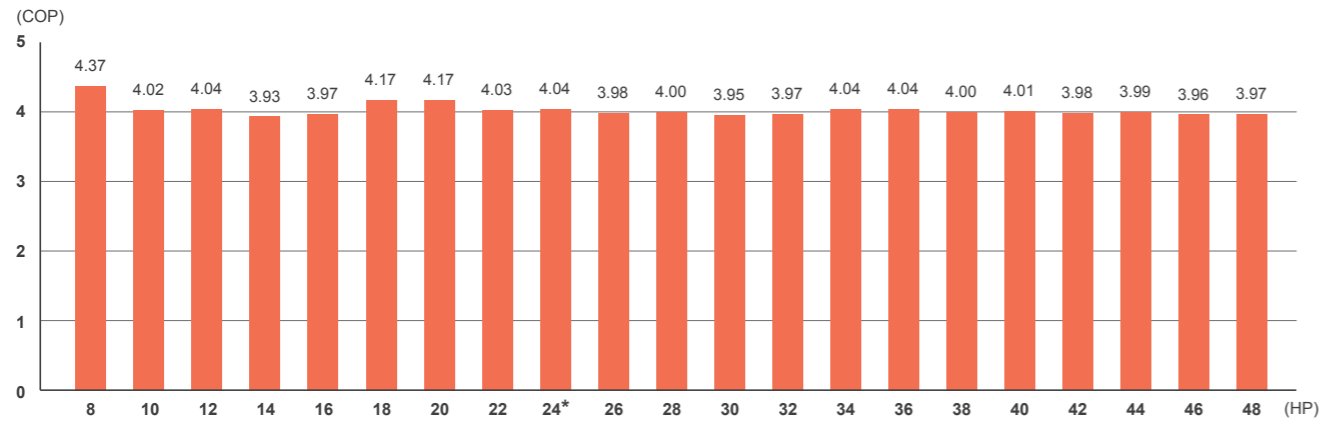

### Energy efficiency combination

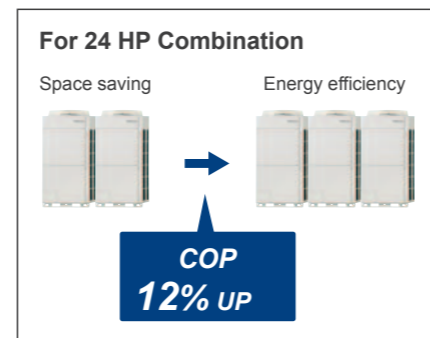
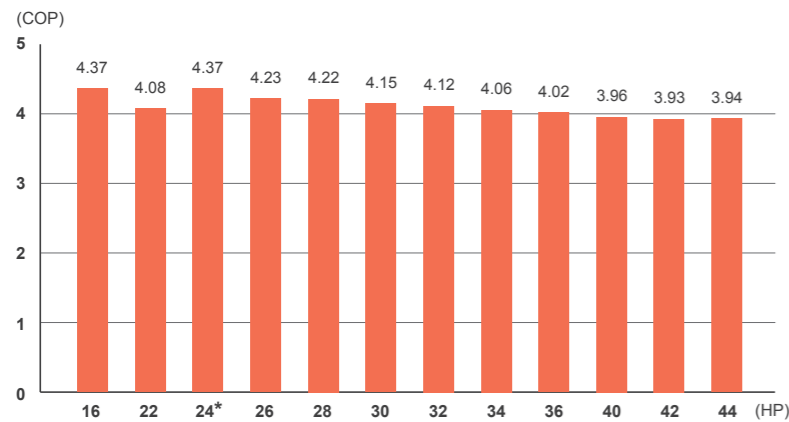

## Features

### Space saving and compact size

Compact size has been achieved by significantly reducing the width of the outdoor units compared to previous models.

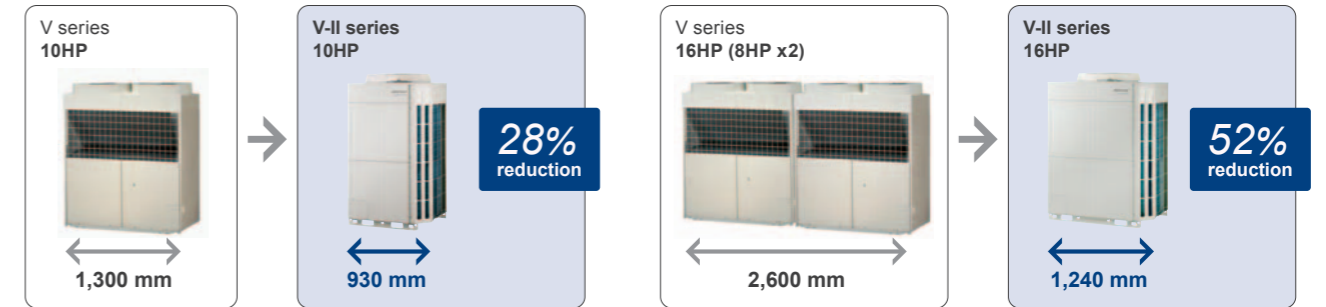

### Energy saving technology that boosted operation efficiency

- Powerful large propeller fan**  
By using CFD\*1 technology, A newly designed fan achieves high performance and low noise operation.  
\*1. CFD = Computational Fluid Dynamics
- DC fan motor**  
Power consumption has been reduced by 25% compared to previous models by using a compact and high performance DC fan motor.
- Subcool heat exchanger**  
High Heat Exchange efficiency is achieved by using an internal projection shape double pipe construction.
- Sine-wave DC inverter control**  
High efficiency operation is realized by using a sine wave DC inverter control.
- DC twin rotary compressor**  
Significantly greater efficiency is realized by use of a large capacity DC twin rotary compressor with substantially increased refrigerant intake and compression efficiency.
- 4-face heat exchanger**  
Heat exchange efficiency is significantly improved by the introduction of a new 4-face heat exchanger that increases effective surface area.
- Front intake port (corner cut air inhaling structure)**  
In multiple outdoor unit installations, the unique front intake design improves airflow into the Heat Exchanger.

## Design Flexibility

### Overall piping length 1,000 m

World's top class overall piping length of 1,000 m allows for application in a wide variety of buildings.

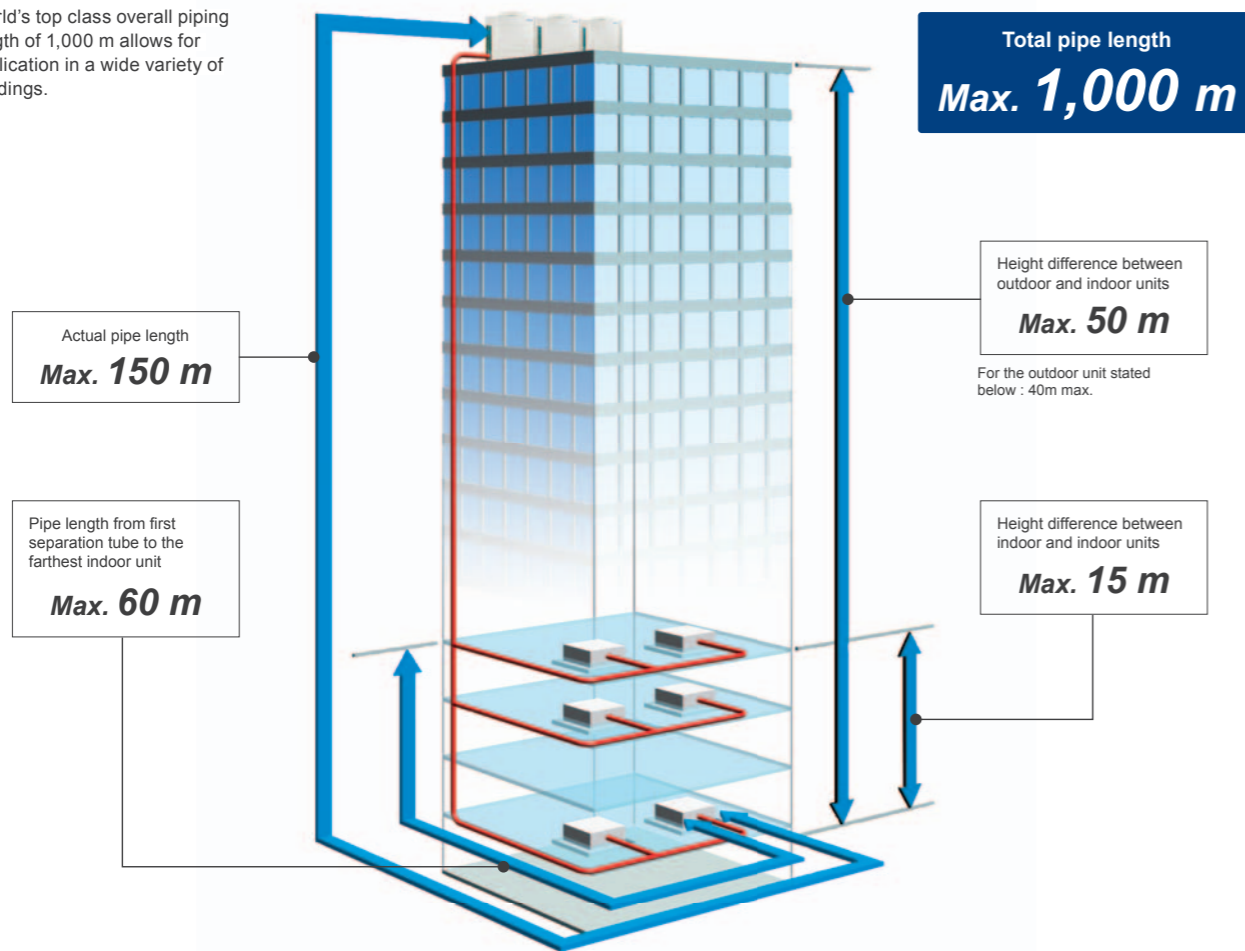

### High static pressure of 80 Pa

The outdoor unit can have a condenser hood easily connected with a static pressure of 80Pa standard. This allows outdoor units to be installed within plant rooms in high rise buildings.

Powerful discharge with an external static pressure of 80 Pa.

**80 Pa**  
as standard

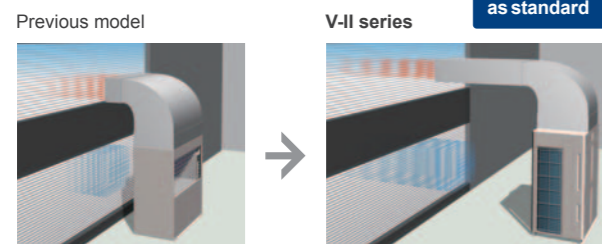

Large diameter fan and DC motor has been utilized allowing an external static pressure of 80 Pa. This is approximately 2.6 times greater than the previous model.

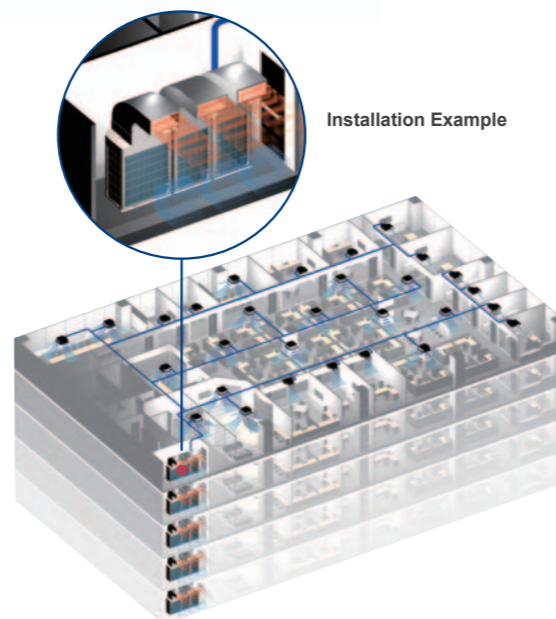

## More Comfort

### Non-stop oil recovery operation

A comfortable room condition is maintained during oil recovery mode because the product continues to operate without stopping the cooling or heating operation.



## Easy Service & Maintenance

Maintenance of electrical components, valves, and compressor parts from the front is possible.

**Split front panel**  
Split front panel allows for maintenance from top or bottom of the outdoor unit

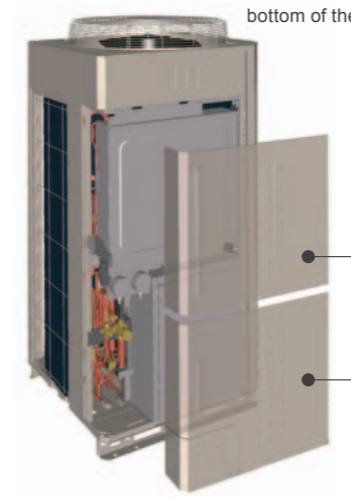

### Continuous operation during maintenance

#### Non-stop operation

When servicing a specific indoor unit, maintenance can be performed even without turning off the other indoor units.

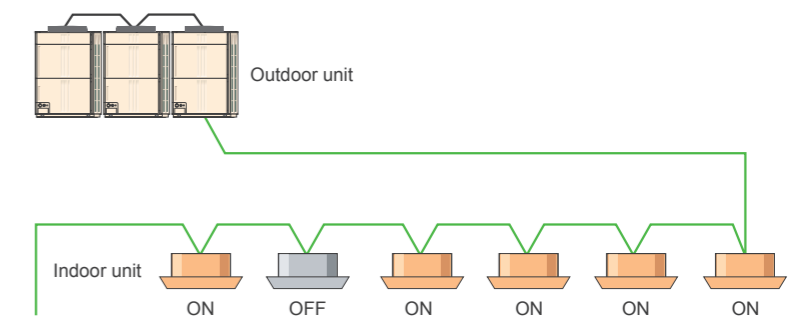

\*Note: VR-II Series and J-II Series are not available.



**Outdoor units lineup**

\*Combinations other than the followings are not recommended.

**Space saving combination**

22.4 kW (8HP)  AJYA72LALH UNIT : AJYA72LALH	28.0 kW (10HP)  AJYA90LALH UNIT : AJYA90LALH	33.5 kW (12HP)  AJY108LALH UNIT : AJY108LALH	40.0 kW (14HP)  AJY126LALH UNIT : AJY126LALH	45.0 kW (16HP)  AJY144LALH UNIT : AJY144LALH
50.4 kW (18HP)  AJY162LALH UNIT : AJYA90/A72LALH	55.9 kW (20HP)  AJY180LALH UNIT : AJY108/A72LALH	61.5 kW (22HP)  AJY198LALH UNIT : AJY108/A90LALH	67.0 kW (24HP)  AJY216LALH UNIT : AJY108/108LALH	73.5 kW (26HP)  AJY234LALH UNIT : AJY126/108LALH
78.5 kW (28HP)  AJY252LALH UNIT : AJY144/108LALH	85.0 kW (30HP)  AJY270LALH UNIT : AJY144/126LALH	90.0 kW (32HP)  AJY288LALH UNIT : AJY144/144LALH	95.0 kW (34HP)  AJY306LALH UNIT : AJY108/108/A90LALH	100.5 kW (36HP)  AJY324LALH UNIT : AJY108/108/108LALH
107.0 kW (38HP)  AJY342LALH UNIT : AJY126/108/108LALH	112.0 kW (40HP)  AJY360LALH UNIT : AJY144/108/108LALH	118.5 kW (42HP)  AJY378LALH UNIT : AJY144/126/108LALH	123.5 kW (44HP)  AJY396LALH UNIT : AJY144/144/108LALH	130.0 kW (46HP)  AJY414LALH UNIT : AJY144/144/126LALH
135.0 kW (48HP)  AJY432LALH UNIT : AJY144/144/144LALH				

**Energy efficiency combination**

44.8 kW (16HP)  AJY144LALHH UNIT : AJYA72/A72LALH	62.4 kW (22HP)  AJY198LALHH UNIT : AJY126/A72LALH	67.2 kW (24HP)  AJY216LALHH UNIT : AJYA72/A72/A72LALH	72.8 kW (26HP)  AJY234LALHH UNIT : AJYA90/A72/A72LALH	78.3 kW (28HP)  AJY252LALHH UNIT : AJY108/A72/A72LALH
84.8 kW (30HP)  AJY270LALHH UNIT : AJY126/A72/A72LALH	89.8 kW (32HP)  AJY288LALHH UNIT : AJY108/108/A72LALH	95.9 kW (34HP)  AJY306LALHH UNIT : AJY126/108/A72LALH	102.4 kW (36HP)  AJY324LALHH UNIT : AJY126/126/A72LALH	113.5 kW (40HP)  AJY360LALHH UNIT : AJY126/126/108LALH
120.0 kW (42HP)  AJY378LALHH UNIT : AJY126/126/126LALH	125.0 kW (44HP)  AJY396LALHH UNIT : AJY144/126/126LALH			

**Dimensions**

(Unit : mm)

8,10,12HP : AJYA72LALH / AJYA90LALH / AJY108LALH

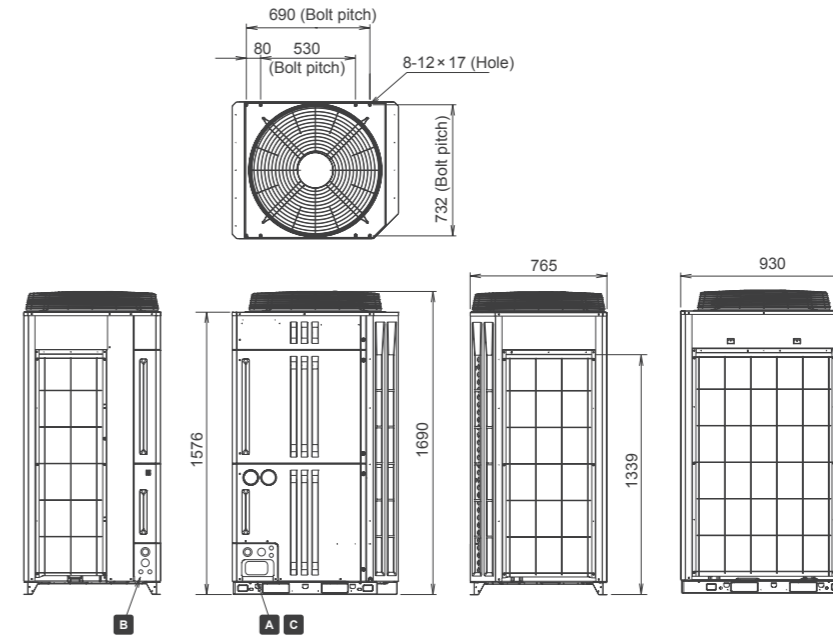

14,16HP : AJY126LALH / AJY144LALH

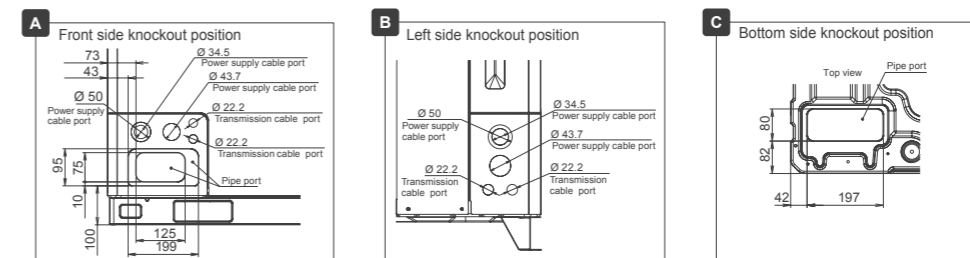
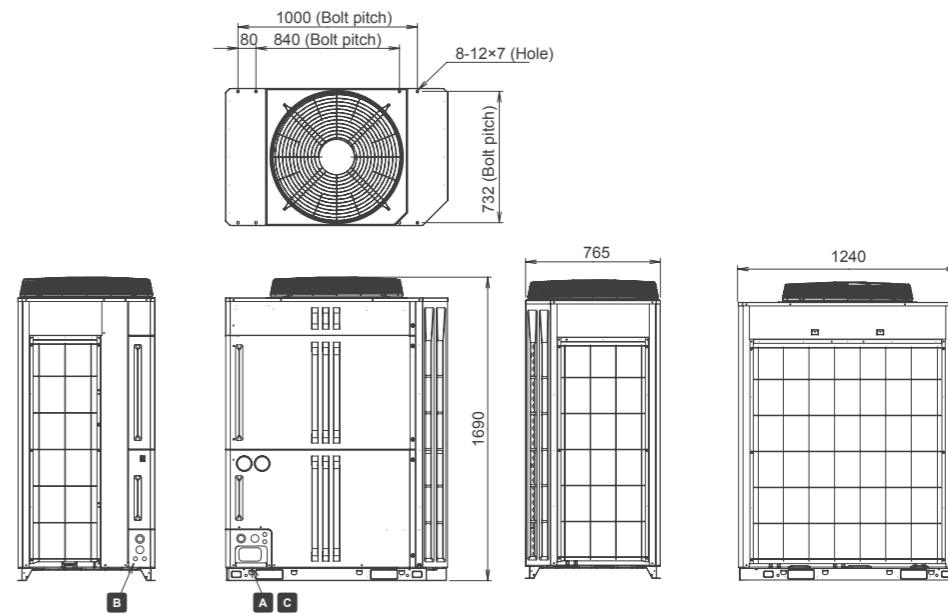

**Outdoor units specifications**

**Space Saving Combination**

Rating Capacity range			8	10	12	14	16	18	20	22	24	26	28	30	32	34	36	38	40	42	44	46	48			
Model name			AJYA72LALH	AJYA90LALH	AJY108LALH	AJY126LALH	AJY144LALH	AJY162LALH	AJY180LALH	AJY198LALH	AJY216LALH	AJY234LALH	AJY252LALH	AJY270LALH	AJY288LALH	AJY306LALH	AJY324LALH	AJY342LALH	AJY360LALH	AJY378LALH	AJY396LALH	AJY414LALH	AJY432LALH			
Unit 1 Unit 2 Unit 3			AJYA72LALH	AJYA90LALH	AJY108LALH	AJY126LALH	AJY144LALH	AJYA90LALH AJYA72LALH	AJY108LALH AJYA72LALH	AJY108LALH AJYA90LALH	AJY108LALH AJY108LALH	AJY126LALH AJY108LALH	AJY126LALH AJY108LALH	AJY144LALH AJY126LALH	AJY144LALH AJY144LALH	AJY108LALH AJYA90LALH	AJY108LALH AJY108LALH	AJY126LALH AJY108LALH	AJY144LALH AJY108LALH	AJY144LALH AJY108LALH	AJY144LALH AJY126LALH	AJY144LALH AJY108LALH	AJY144LALH AJY126LALH	AJY144LALH AJY144LALH		
Maximum Connectable Indoor Unit*1			15	16	17	21	24	32	32	35	39	42	45	48	48	48	48	48	48	48	48	48	48			
Indoor unit connectable capacity			11.2-33.6	14.0-42.0	16.8-50.2	20.0-60.0	22.5-67.5	25.2-75.6	28.0-83.8	30.8-92.2	33.5-100.5	36.8-110.2	39.3-117.7	42.5-127.5	45.0-135.0	47.5-142.5	50.3-150.7	53.5-160.5	56.0-168.0	59.3-177.7	61.8-185.2	65.0-195.0	67.5-202.5			
Power source			3-phase 4 wire, 400 V, 50Hz											3-phase 4 wire, 400 V, 50Hz												
Capacity			Cooling		Heating		Cooling		Heating		Cooling		Heating		Cooling		Heating		Cooling		Heating		Cooling		Heating	
Input power			Cooling		Heating		Cooling		Heating		Cooling		Heating		Cooling		Heating		Cooling		Heating		Cooling		Heating	
EER			Cooling		Heating		Cooling		Heating		Cooling		Heating		Cooling		Heating		Cooling		Heating		Cooling		Heating	
COP			Cooling		Heating		Cooling		Heating		Cooling		Heating		Cooling		Heating		Cooling		Heating		Cooling		Heating	
Air flow rate			High		Medium		Low		High		Medium		Low		High		Medium		Low		High		Medium		Low	
Sound pressure level*2			Cooling		Heating		Cooling		Heating		Cooling		Heating		Cooling		Heating		Cooling		Heating		Cooling		Heating	
Maximum external static pressure			Cooling		Heating		Cooling		Heating		Cooling		Heating		Cooling		Heating		Cooling		Heating		Cooling		Heating	
Compressor motor output			Cooling		Heating		Cooling		Heating		Cooling		Heating		Cooling		Heating		Cooling		Heating		Cooling		Heating	
Heat exchanger fin			Blue fin		Blue fin		Blue fin		Blue fin		Blue fin		Blue fin		Blue fin		Blue fin		Blue fin		Blue fin		Blue fin		Blue fin	
Dimensions			Height		Width		Depth		Height		Width		Depth		Height		Width		Depth		Height		Width		Depth	
Weight			kg		kg		kg		kg		kg		kg		kg		kg		kg		kg		kg		kg	
Refrigerant charge			kg		kg		kg		kg		kg		kg		kg		kg		kg		kg		kg		kg	
Connection pipe diameter			Liquid		Gas		Liquid		Gas		Liquid		Gas		Liquid		Gas		Liquid		Gas		Liquid		Gas	
Operation range			Cooling		Heating		Cooling		Heating		Cooling		Heating		Cooling		Heating		Cooling		Heating		Cooling		Heating	

**Energy Efficiency Combination**

Rating Capacity range			16	22	24	26	28	30	32	34	36	40	42	44
Model name			AJY144LALHH	AJY198LALHH	AJY216LALHH	AJY234LALHH	AJY252LALHH	AJY270LALHH	AJY288LALHH	AJY306LALHH	AJY324LALHH	AJY360LALHH	AJY378LALHH	AJY396LALHH
Unit 1 Unit 2 Unit 3			AJYA72LALH AJYA72LALH	AJY126LALH AJYA72LALH	AJYA72LALH AJYA72LALH AJYA72LALH	AJYA90LALH AJYA72LALH AJYA72LALH	AJY108LALH AJYA72LALH AJYA72LALH	AJY126LALH AJYA72LALH AJYA72LALH	AJY108LALH AJY108LALH AJYA72LALH	AJY126LALH AJY108LALH AJYA72LALH	AJY126LALH AJYA72LALH	AJY126LALH AJY108LALH AJY108LALH	AJY126LALH AJY126LALH AJY126LALH	AJY144LALH AJY126LALH AJY126LALH
Maximum Connectable Indoor Unit*1			30	33	36	39	42	45	48	48	48	48	48	
Indoor unit connectable capacity			22.4-67.2	31.2-93.6	33.6-100.8	36.4-109.2	39.2-117.4	42.4-127.2	44.7-134.1	48.0-143.8	51.2-153.6	56.8-170.2	62.5-187.5	
Power source			3-phase 4 wire, 400 V, 50Hz						3-phase 4 wire, 400 V, 50Hz					
Capacity			Cooling		Heating		Cooling		Heating		Cooling		Heating	
Input power			Cooling		Heating		Cooling		Heating		Cooling		Heating	
EER			Cooling		Heating		Cooling		Heating		Cooling		Heating	
COP			Cooling		Heating		Cooling		Heating		Cooling		Heating	
Air flow rate			High		Medium		Low		High		Medium		Low	
Sound pressure level*2			Cooling		Heating		Cooling		Heating		Cooling		Heating	
Maximum external static pressure			Cooling		Heating		Cooling		Heating		Cooling		Heating	
Compressor motor output			Cooling		Heating		Cooling		Heating		Cooling		Heating	
Heat exchanger fin			Blue fin		Blue fin		Blue fin		Blue fin		Blue fin		Blue fin	
Dimensions			Height		Width		Depth		Height		Width		Depth	
Weight			kg		kg		kg		kg		kg		kg	
Refrigerant charge			kg		kg		kg		kg		kg		kg	
Connection pipe diameter			Liquid		Gas		Liquid		Gas		Liquid		Gas	
Operation range			Cooling		Heating		Cooling		Heating		Cooling		Heating	

Note : Specifications are based on the following conditions.  
Cooling : Indoor temperature of 27°CDB / 19°CWB, and outdoor temperature of 35°CDB / 24°CWB.  
Heating : Indoor temperature of 20°CDB / (15°CWB), and outdoor temperature of 7°CDB / 6°CWB.

Pipe length : 7.5 m; Height difference between outdoor unit and indoor unit : 0 m.  
When cooling operation will be conducted at outdoor air temperature below -5°C, the outdoor unit must be installed in a position that is higher than or equal to those of indoor units.

\*1 Minimum connectable indoor unit number is 2.  
However ARXC72 and ARXC90 can be used signal connection.  
\*2 The noise value is the value when measured in an anechoic room.

When measured in the actual installed state, surrounding noise and reflections are received and the measured value is usually larger than the indicated value.

## NEW Heat Recovery

Smart and cutting edge design  
 Extensive lineup from 8HP to 48HP in 2HP increment  
 Connectable indoor unit capacity ratio up to 150%



## Features

### High Efficiency

#### Efficiency in actual operation

Top class high COP is achieved for all combinations by our unique heat exchanger structure, high efficient DC twin compressor, and our own technologies.

#### Space saving combination

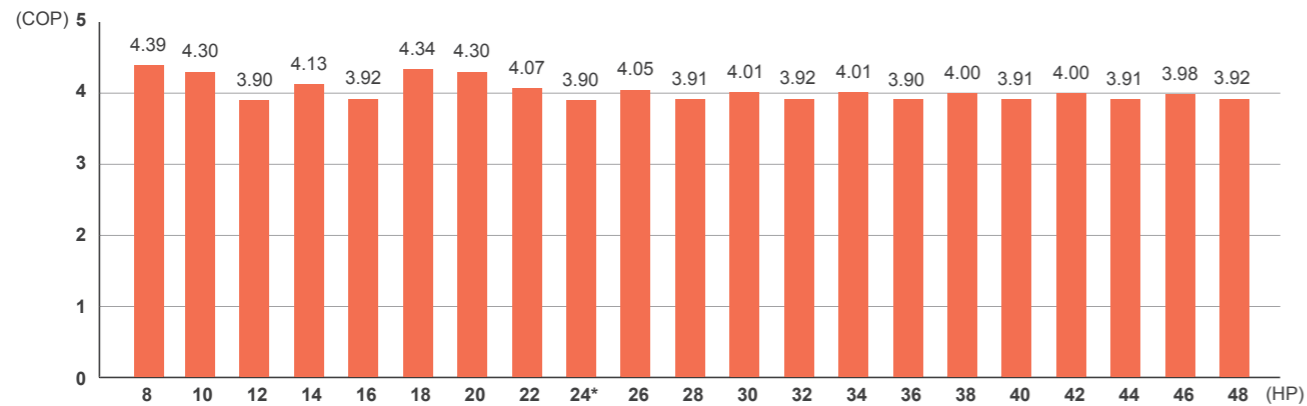

#### Energy efficiency combination

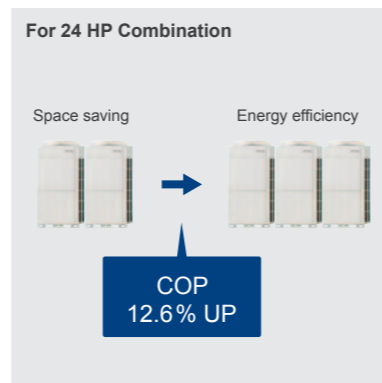
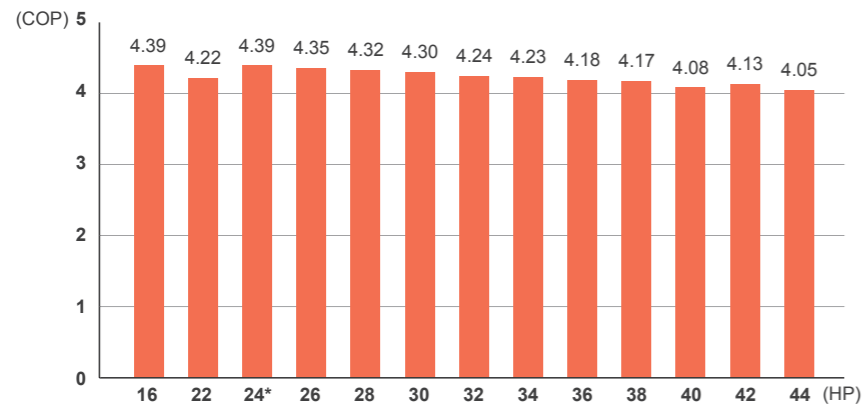

## Features

### Energy saving technology that boosted operation efficiency

- Powerful large propeller fan**  
By using CFD<sup>\*1</sup> technology, a newly designed fan achieves high performance and low noise operation.  
\*1. CFD = Computational Fluid Dynamics
- 3 phase DC fan motor**  
Efficiency is substantially improved by high efficient motor with sophisticated driver control. In addition, low noise is realized by DC fan motor.
- Subcool heat exchanger**  
High Heat Exchange efficiency is achieved by using an internal projection shape double pipe construction.
- Sine-wave DC inverter control**  
High efficiency is realized by adoption of reduced switching loss IPM.
- High efficient compressor Large capacity DC inverter compressor**  
Large capacity high efficient DC twin rotary compressor with excellent intermediate capability.
- 4-face heat exchanger**  
Heat exchange efficiency is significantly improved by the introduction of a new 4-face heat exchanger that increases effective surface area.
- Front intake port (corner cut air inhaling structure)**  
In multiple outdoor unit installations, the unique front intake design improves airflow into the Heat Exchanger.

### Ideal heat exchanger path control

Heat exchanger is split into top and bottom. Heat exchange efficiency is improved by optimum heat exchanger path refrigerant control. Refrigerant is more distributed at the top side heat exchanger with a large intake airflow.

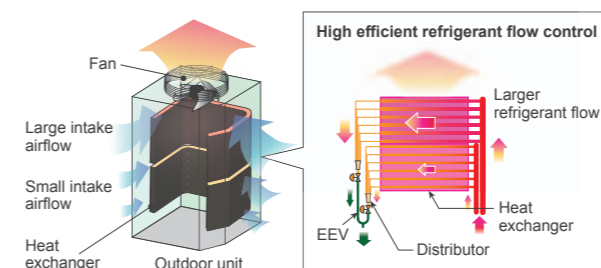

### Sophisticated operation control

When multiple outdoor units are connected, sophisticated operation is performed by each compressor. Efficiency is improved by all compressors at part load and distributing refrigerant to all of the heat exchangers rather than to one compressor.

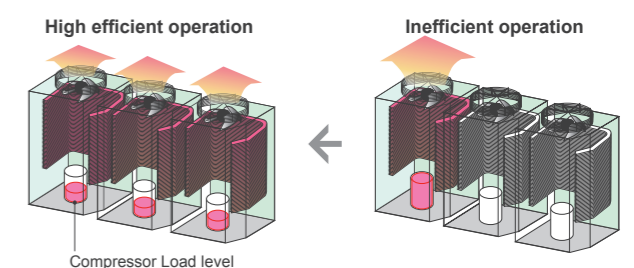



## Design Flexibility

Overall piping length 1,000 m

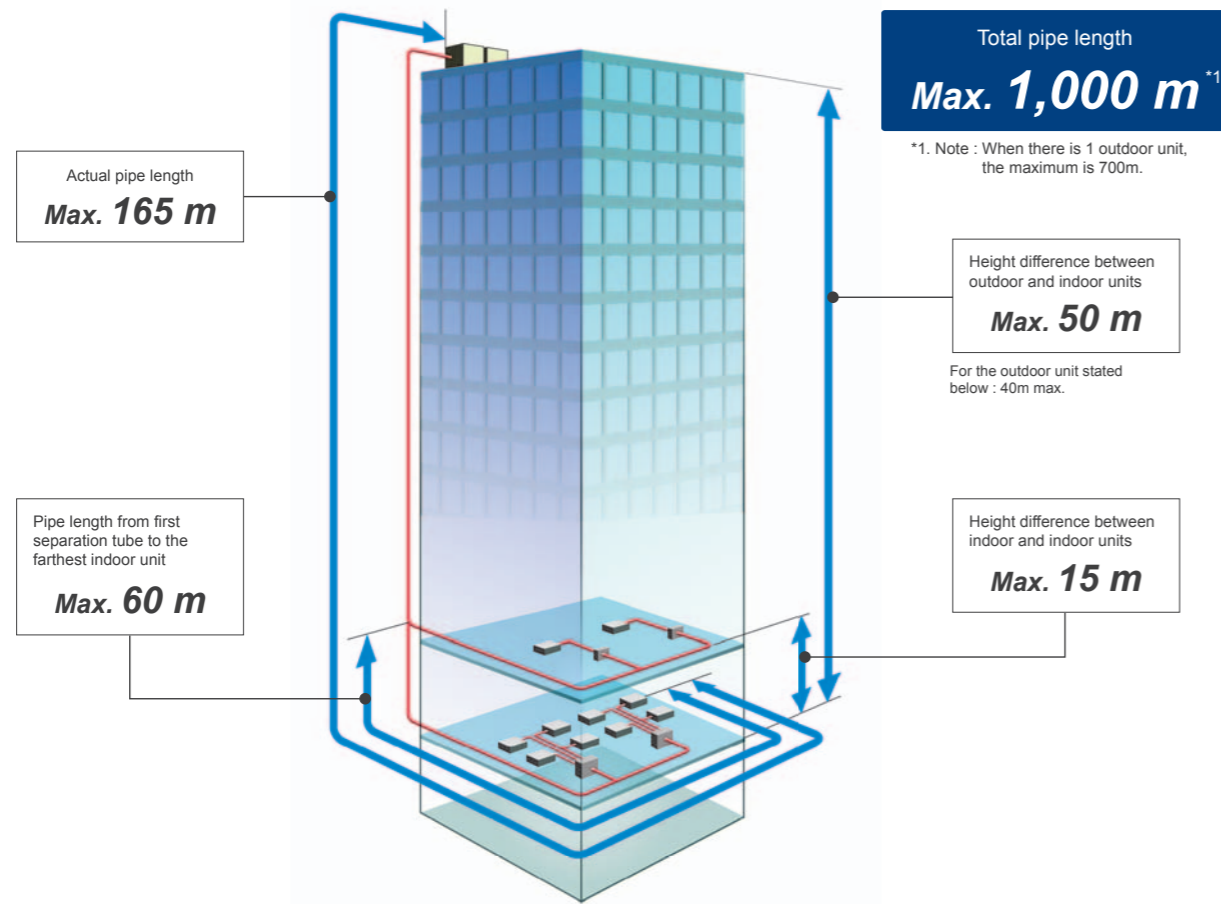

## High static pressure of 80 Pa

Large diameter fan and 3 phase DC motor has been utilized allowing an external static pressure of 80 Pa. This allows outdoor units to be installed on balconies, etc. on each floor in high rise buildings.

Powerful discharge with an external static pressure of 80 Pa.

**80 Pa**  
as standard

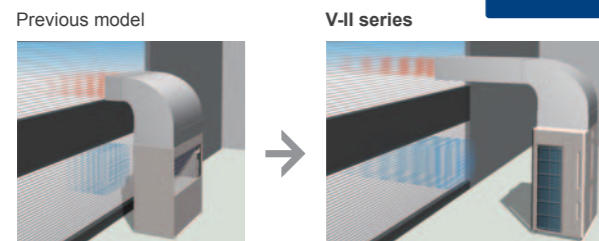

Large diameter fan and DC motor has been utilized allowing an external static pressure of 80Pa. This is approximately 2.6 times greater than the previous model.

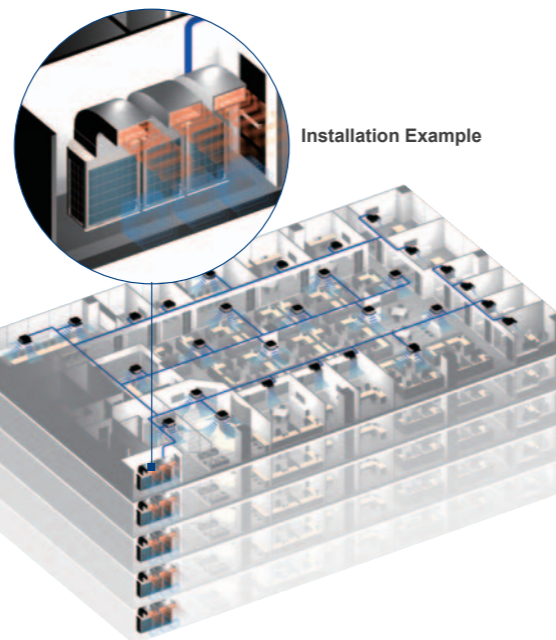

## Flexible piping connection

A more flexible refrigerant piping work is possible by the use of various piping and RB Unit connections, for adjustments to the floor layout and building structure.

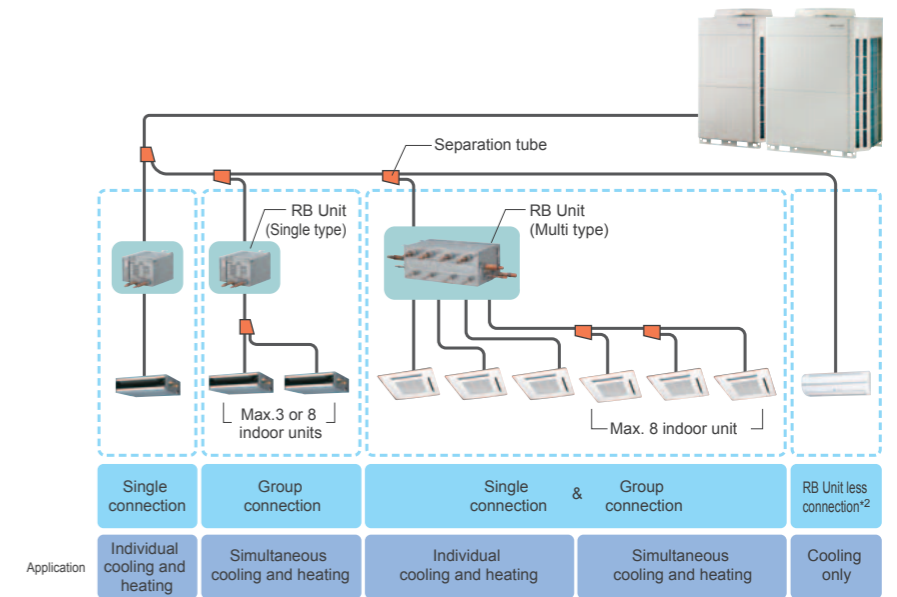

- The RB unit can be freely positioned between the first branch and the indoor unit.
- The maximum height difference between RB units is 15 m.
- \*2. RB Unit is not necessary for cooling only use.

## Easy Installation & Maintenance

### Flexible installation of RB unit

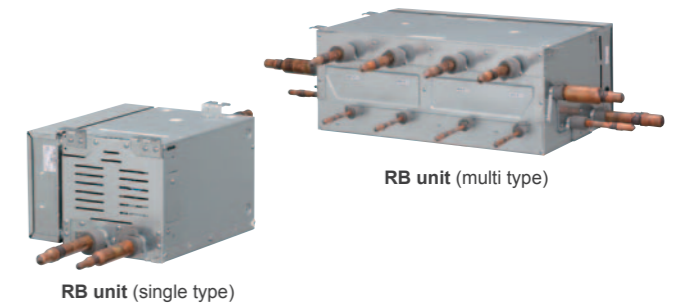
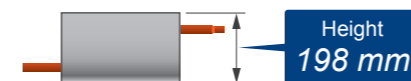

- Small & slim design saves space
- A drain pipe is not required
- The control box position can be changed to meet the installation conditions



Installation possible from either side for freedom of the control box

Installation possible on the upper-side for use in narrow space

- Small design saves space
- A drain pipe is not required
- Simple installation series connection design

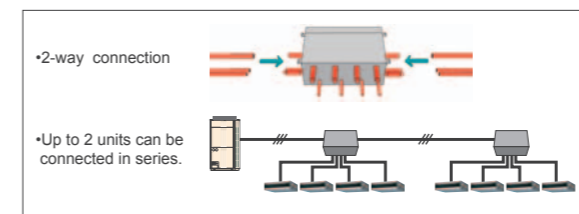

### Easy to maintain in a narrow space



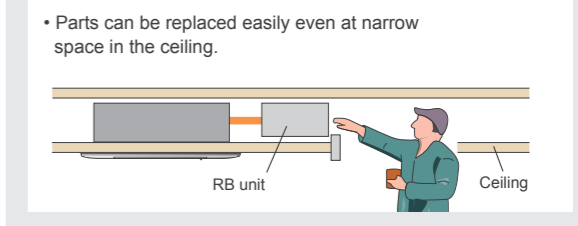















- Maintenance can be performed from the side.
- Electric box can be temporarily fixed by sliding down.



## Outdoor units lineup

\*Combinations other than the followings are not recommended.

### Space saving combination

22.4 kW (8HP)  AJYA72GALH UNIT : AJYA72GALH	28.0 kW (10HP)  AJYA90GALH UNIT : AJYA90GALH	33.5 kW (12HP)  AJY108GALH UNIT : AJY108GALH	40.0 kW (14HP)  AJY126GALH UNIT : AJY126GALH	45.0 kW (16HP)  AJY144GALH UNIT : AJY144GALH
50.4 kW (18HP)  AJY162GALH UNIT : AJYA90/A72GALH	56.0 kW (20HP)  AJY180GALH UNIT : AJYA90/A90GALH	61.5 kW (22HP)  AJY198GALH UNIT : AJY108/A90GALH	67.0 kW (24HP)  AJY216GALH UNIT : AJY108/108GALH	73.0 kW (26HP)  AJY234GALH UNIT : AJY144/A90GALH
78.5 kW (28HP)  AJY252GALH UNIT : AJY144/108GALH	85.0 kW (30HP)  AJY270GALH UNIT : AJY144/126GALH	90.0 kW (32HP)  AJY288GALH UNIT : AJY144/144GALH	95.0 kW (34HP)  AJY306GALH UNIT : AJY108/108/A90GALH	100.5 kW (36HP)  AJY324GALH UNIT : AJY108/108/108GALH
106.5 kW (38HP)  AJY342GALH UNIT : AJY144/108/A90GALH	112.0 kW (40HP)  AJY360GALH UNIT : AJY144/108/108GALH	118.0 kW (42HP)  AJY378GALH UNIT : AJY144/144/A90GALH	123.5 kW (44HP)  AJY396GALH UNIT : AJY144/144/108GALH	130.0 kW (46HP)  AJY414GALH UNIT : AJY144/144/126GALH
135.0 kW (48HP)  AJY432GALH UNIT : AJY144/144/144GALH				

### Energy efficiency combination

44.8 kW (16HP)  AJY144GALHH UNIT : AJYA72/A72GALH	62.4 kW (22HP)  AJY198GALHH UNIT : AJY126/A72GALH	67.2 kW (24HP)  AJY216GALHH UNIT : AJYA72/A72/A72GALH	72.8 kW (26HP)  AJY234GALHH UNIT : AJYA90/A72/A72GALH	78.4 kW (28HP)  AJY252GALHH UNIT : AJYA90/A90/A72GALH
84.0 kW (30HP)  AJY270GALHH UNIT : AJYA90/A90/A90GALH	90.4 kW (32HP)  AJY288GALHH UNIT : AJY126/A90/A72GALH	96.0 kW (34HP)  AJY306GALHH UNIT : AJY126/A90/A90GALH	102.4 kW (36HP)  AJY324GALHH UNIT : AJY126/126/A72GALH	108.0 kW (38HP)  AJY342GALHH UNIT : AJY126/126/A90GALH
113.0 kW (40HP)  AJY360GALHH UNIT : AJY144/126/A90GALH	120.0 kW (42HP)  AJY378GALHH UNIT : AJY126/126/126GALH	125.0 kW (44HP)  AJY396GALHH UNIT : AJY144/126/126GALH		

## Dimensions

(Unit : mm)

8,10,12HP : AJYA72GALH / AJYA90GALH / AJY108GALH

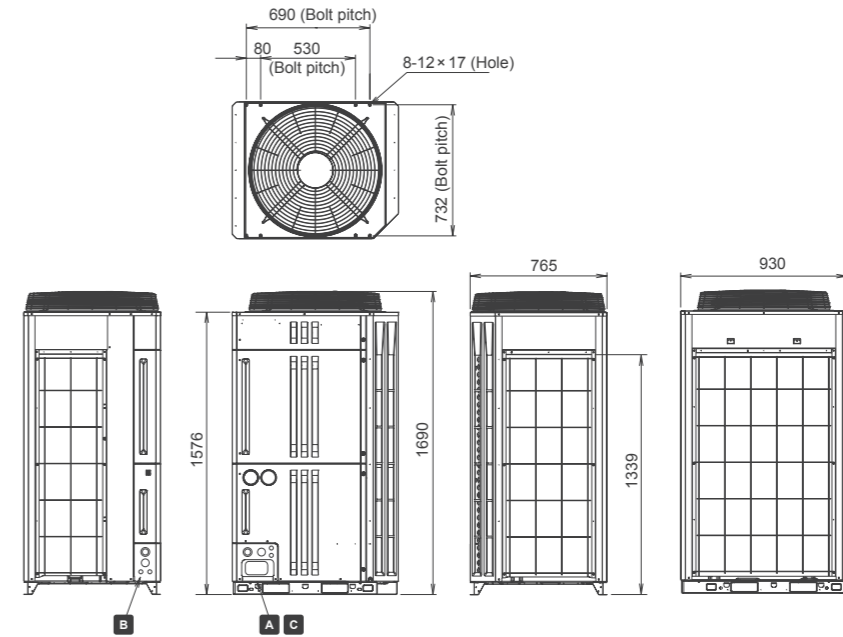



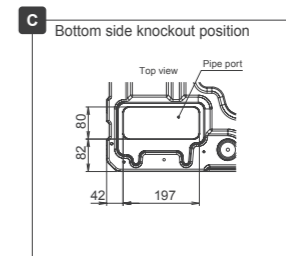
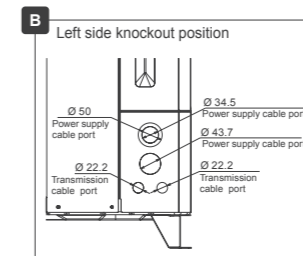
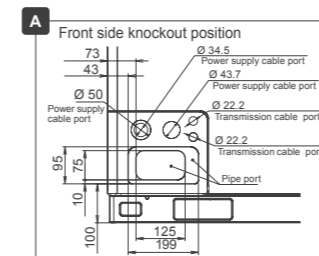
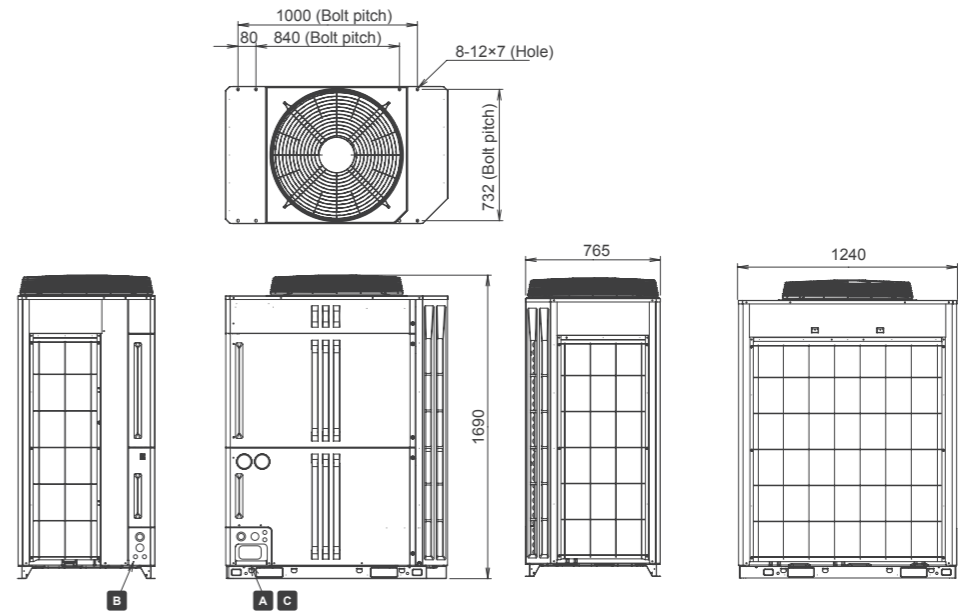





















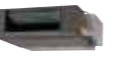









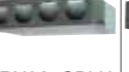

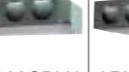

































14,16HP : AJY126GALH / AJY144GALH





**Indoor Unit Lineup**

12 Types, 55 Models, Capacity range from 1.1 kW to 25.0 kW

Capacity range (kW)		1.1	2.2	2.8	3.6	4.5	5.6	7.1	9.0	11.2	12.5	14.0	18.0	22.4	25.0	
Model code		4	7	9	12	14	18	24	30	36	45	54	60	72	90	
<b>Cassette</b>	Compact Cassette	 AUXB04GALH	 AUXB07GALH	 AUXB09GALH	 AUXB12GALH	 AUXB14GALH	 AUXB18GALH	 AUXB24GALH								
	Cassette						 AUXD18GALH	 AUXD24GALH	 AUXA30GALH	 AUXA36GALH	 AUXA45GALH	 AUXA54GALH				
<b>Duct</b>	Low Static Pressure Duct		 ARXB07GALH	 ARXB09GALH	 ARXB12GALH	 ARXB14GALH	 ARXB18GALH									
	Slim Duct (With drain pump)	 ARXD04GALH	 ARXD07GALH	 ARXD09GALH	 ARXD12GALH	 ARXD14GALH	 ARXD18GALH	 ARXD24GALH								
	Medium Static Pressure Duct							 ARXA24GBLH	 ARXA30GBLH	 ARXA36GBLH	 ARXA45GBLH					
	High Static Pressure Duct									 ARXC36GATH	 ARXC45GATH		 ARXC60GATH*	 ARXC72GATH*	 ARXC90GATH*	
<b>Floor</b>	Floor (*Same as Ceiling models)				 ABYA12GATH	 ABYA14GATH	 ABYA18GATH	 ABYA24GATH								
	Concealed Floor (*Same as Low Static Pressure Duct models)		 ARXB07GALH	 ARXB09GALH	 ARXB12GALH	 ARXB14GALH	 ARXB18GALH									
	Slim Concealed Floor (*Same as Slim Duct models)	 ARXD04GALH	 ARXD07GALH	 ARXD09GALH	 ARXD12GALH	 ARXD14GALH	 ARXD18GALH	 ARXD24GALH								
<b>Ceiling</b>	Ceiling				 ABYA12GATH	 ABYA14GATH	 ABYA18GATH	 ABYA24GATH	 ABYA30GATH	 ABYA36GATH	 ABYA45GATH	 ABYA54GATH				
<b>Wall Mounted</b>	Wall Mounted	 ASYA04GACH	 ASYA07GACH	 ASYA09GACH	 ASYA12GACH	 ASYA14GACH	 ASYA18GACH	 ASYA24GACH	 ASYA30GACH							
	Wall Mounted (EEV external)	 ASYE04GACH	 ASYE07GACH	 ASYE09GACH	 ASYE12GACH	 ASYE14GACH										

With this model, connection of EV kit is necessary.

\*: ARXC60/72/90LATH cannot be connected to J-IIS and J-II series.

**Indoor Units Specifications**

**Compact Cassette**



Model name		AUXB04GALH	AUXB07GALH	AUXB09GALH	AUXB12GALH	AUXB14GALH	AUXB18GALH	AUXB24GALH
Power source		230/1/50						
Capacity	Cooling	1.1	2.2	2.8	3.6	4.5	5.6	7.1
	Heating	1.3	2.8	3.2	4.1	5.0	6.3	8.0
Input power		W						
Airflow rate	High	530	540	550	600	680	710	1,030
	Med	420/450*1	450	450	530	590	580	830
	Low	300/350*1	350	350	390	390	400	450
Sound pressure level	High	34	34	35	37	38	41	50
	Med	28/30*1	30	30	34	34	35	44
	Low	21/25*1	25	25	27	27	27	30
Dimensions (H x W x D)		mm 245 x 570 x 570						
Weight		kg 15						
Connection pipe diameter	Liquid (Flare)	ø6.35			ø9.52			
	Gas (Flare)	ø12.70			ø15.88			
	Drain hose	VP [ø25 (I.D.) ; ø32 (O.D.)]						
Cassette Grille	Model name	UTG-UFYC-W						
	Dimensions (H x W x D)	mm 50 x 700 x 700						
	Weight	kg 2.6						

Note : Specifications are based on the following conditions. Cooling : Indoor temperature of 27°CDB / 19°CWB, and outdoor temperature of 35°CDB / 24°CWB. Heating : Indoor temperature of 20°CDB / (15°CWB), and outdoor temperature of 7°CDB / 6°CWB. Pipe length : 7.5 m; Height difference between outdoor unit and indoor unit : 0 m. Voltage : 230 [V]. \*1: This value is under cooling operation.

**Cassette**

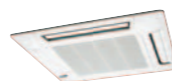

Model name		AUXD18GALH	AUXD24GALH	AUXA30GALH	AUXA36GALH	AUXA45GALH	AUXA54GALH
Power source		230/1/50					
Capacity	Cooling	5.6	7.1	9.0	11.2	12.5	14.0
	Heating	6.3	8.0	10.0	12.5	14.0	16.0
Input power		W					
Airflow rate	High	1,150	1,280	1,600	1,800	1,900	2,000
	Med	940	1,040	1,300	1,300	1,370	1,370
	Low	870	870	1,100	1,100	1,100	1,100
Sound pressure level	High	36	38	40	44	46	47
	Med	30	33	38	38	39	39
	Low	29	29	33	33	33	33
Dimensions (H x W x D)		mm 246 x 840 x 840		288 x 840 x 840			
Weight		kg 22		27			
Connection pipe diameter	Liquid (Flare)	ø15.88			ø9.52		
	Gas (Flare)	ø15.88			ø19.05		
	Drain hose	VP25 [ø25 (I.D.) ; ø32 (O.D.)]					
Cassette Grille	Model name	UTG-UGYA-W					
	Dimensions (H x W x D)	mm 50 x 950 x 950					
	Weight	kg 5.5					

Note : Specifications are based on the following conditions. Cooling : Indoor temperature of 27°CDB / 19°CWB, and outdoor temperature of 35°CDB / 24°CWB. Heating : Indoor temperature of 20°CDB / (15°CWB), and outdoor temperature of 7°CDB / 6°CWB. Pipe length : 7.5 m; Height difference between outdoor unit and indoor unit : 0 m. Voltage : 230 [V].

**Low Static Pressure Duct / Concealed Floor**



Model name		ARXB07GALH	ARXB09GALH	ARXB12GALH	ARXB14GALH	ARXB18GALH
Power source		230/1/50				
Capacity	Cooling	2.2	2.8	3.6	4.5	5.6
	Heating	2.8	3.2	4.0	5.0	6.3
Input power		W				
Airflow rate	High	370	440	590	800	890
	Med	310	370	500	750	810
	Low	280	340	450	700	730
Static pressure range		Pa 0 to 50				
Standard static pressure		Pa 25				
Sound pressure level	High	29	31	30	33	36
	Med	26	29	28	32	34
	Low	24	27	25	30	30
Dimensions (H x W x D)		mm 217 x 663 x 595			217 x 953 x 595	
Weight		kg 15			22	
Connection pipe diameter	Liquid (Flare)	ø6.35			ø9.52	
	Gas (Flare)	ø12.70			ø15.88	
	Drain hose	VP25 [ø25 (I.D.) ; ø32 (O.D.)]				

Note : Specifications are based on the following conditions. Cooling : Indoor temperature of 27°CDB / 19°CWB, and outdoor temperature of 35°CDB / 24°CWB. Heating : Indoor temperature of 20°CDB / (15°CWB), and outdoor temperature of 7°CDB / 6°CWB. Pipe length : 7.5 m; Height difference between outdoor unit and indoor unit : 0 m.

**Slim Duct / Slim Concealed Floor**



Model name		ARXD04GALH	ARXD07GALH	ARXD09GALH	ARXD12GALH	ARXD14GALH	ARXD18GALH	ARXD24GALH	
Power source		230/1/50							
Capacity	Cooling	1.1	2.2	2.8	3.6	4.5	5.6	7.1	
	Heating	1.3	2.8	3.2	4.0	5.0	6.3	8.0	
Input power		W							
Airflow rate	High	510	550	600	600	800	940	1,330	
	Med	400/470*1	490	550	510	710	840	1,240	
	Low	320/440*1	440	480	450	610	750	1,100	
Static pressure range		Pa 0 to 90							
Standard static pressure		Pa 25							
Sound pressure level	High	26	28	29	30	34	34	35	
	Med	21/25*1	25	26	27	32	32	32	
	Low	20/22*1	22	24	24	28	28	29	
Dimensions (H x W x D)		mm 198 x 700 x 620					198 x 900 x 620		198 x 1,100 x 620
Weight		kg 17					18		22
Connection pipe diameter	Liquid (Flare)	ø6.35			ø9.52				
	Gas (Flare)	ø12.70			ø15.88				
	Drain hose	VP25 [ø25 (I.D.) ; ø32 (O.D.)]							

Note : Specifications are based on the following conditions. Cooling : Indoor temperature of 27°CDB / 19°CWB, and outdoor temperature of 35°CDB / 24°CWB. Heating : Indoor temperature of 20°CDB / (15°CWB), and outdoor temperature of 7°CDB / 6°CWB. Pipe length : 7.5 m; Height difference between outdoor unit and indoor unit : 0 m. \*1: This value is under cooling operation.

**Medium Static Pressure Duct**



Model name		ARXA24GBLH	ARXA30GBLH	ARXA36GBLH	ARXA45GBLH
Power source		230/1/50			
Capacity	Cooling	7.1	9.0	11.2	12.5
	Heating	8.0	10.0	12.5	14.0
Input power		W			
Airflow rate	High	1,280	1,410	1,840	1,970
	Med	990	1,280	1,600	1,860
	Low	840	1,150	1,470	1,640
Static pressure range		Pa 0 to 150			
Standard static pressure		Pa 40			
Sound pressure level	High	31	34	37	41
	Med	27	32	35	38
	Low	23	29	33	36
Dimensions (H x W x D)		mm 270 x 1,135 x 700			
Weight		kg 36		40	
Connection pipe diameter	Liquid (Flare)	ø9.52			
	Gas (Flare)	ø15.88		ø19.05	
	Drain hose	VP25 [ø25 (I.D.) ; ø32 (O.D.)]			

Note : Specifications are based on the following conditions. Cooling : Indoor temperature of 27°CDB / 19°CWB, and outdoor temperature of 35°CDB / 24°CWB. Heating : Indoor temperature of 20°CDB / (15°CWB), and outdoor temperature of 7°CDB / 6°CWB. Pipe length : 7.5 m; Height difference between outdoor unit and indoor unit : 0 m.

**Indoor Units Specifications**

High Static Pressure Duct



Model name		ARXC36GATH	ARXC45GATH	ARXC60GATH*	ARXC72GATH*	ARXC90GATH*
Power source		230/1/50				
Capacity	Cooling	11.2	12.5	18.0	22.4	25.0
	Heating	12.5	14.0	20.0	25.0	28.0
Input power		405	715	730	1,110	1,250
Airflow rate	High	2,600	3,500	3,500	3,900	4,300
	Med	1,950	3,000	3,000	3,300	4,000
	Low	1,450	2,460	2,460	3,000	3,500
Static pressure range		100 to 200	100 to 250	100 to 250	50 to 300	100 to 300
Standard static pressure		100	100	100	260	250
Sound pressure level	High	45	49	49	51	53
	Med	38	45	45	48	51
	Low	32	42	42	45	49
Dimensions (H x W x D)		400 x 1,050 x 500			450 x 1,550 x 700	
Weight		43	46		83	85
Connection pipe diameter	Liquid	ø9.52 (Flare)			ø12.70 (Brazing)	
	Gas	ø19.05 (Flare)			ø22.22 (Brazing)	
	Drain hose	VP25 [ø25 (I.D.) ; ø32 (O.D.)]				

Note : Specifications are based on the following conditions. Cooling : Indoor temperature of 27°CDB / 19°CWB, and outdoor temperature of 35°CDB / 24°CWB. Heating : Indoor temperature of 20°CDB / (15°CWB), and outdoor temperature of 7°CDB / 6°CWB. Pipe length : 7.5 m; Height difference between outdoor unit and indoor unit : 0 m.

Floor / Ceiling



Model name		ABYA12GATH	ABYA14GATH	ABYA18GATH	ABYA24GATH
Power source		230/1/50			
Capacity	Cooling	3.6	4.5	5.6	7.1
	Heating	4.0	5.0	6.3	8.0
Input power		30	42	74	99
Airflow rate	High	660	780	1,000	1,000
	Med	570	640	720	820
	Low	490	550	580	680
Sound pressure level	High	36	40	46	47
	Med	32	36	39	42
	Low	28	34	35	37
Dimensions (H x W x D)		199 x 990 x 655			
Weight		25	26	26	27
Connection pipe diameter	Liquid (Flare)	ø6.35		ø9.52	
	Gas (Flare)	ø12.70		ø15.88	
	Drain hose	VP25 [ø25 (I.D.) ; ø32 (O.D.)]			

Note : Specifications are based on the following conditions. Cooling : Indoor temperature of 27°CDB / 19°CWB, and outdoor temperature of 35°CDB / 24°CWB. Heating : Indoor temperature of 20°CDB / (15°CWB), and outdoor temperature of 7°CDB / 6°CWB. Pipe length : 7.5 m; Height difference between outdoor unit and indoor unit : 0 m. Voltage : 230 [V].

Ceiling



Model name		ABYA30GATH	ABYA36GATH	ABYA45GATH	ABYA54GATH
Power source		230/1/50			
Capacity	Cooling	9.0	11.2	12.5	14.0
	Heating	10.0	12.5	14.0	16.0
Input power		66	85	131	180
Airflow rate	High	1,630	1,690	2,010	2,270
	Med	1,370	1,400	1,600	1,780
	Low	1,140	1,170	1,230	1,280
Sound pressure level	High	42	45	48	51
	Med	38	38	42	45
	Low	33	34	35	36
Dimensions (H x W x D)		240 x 1,660 x 700			
Weight		46		48	
Connection pipe diameter	Liquid (Flare)	ø9.52		ø9.52	
	Gas (Flare)	ø15.88		ø19.05	
	Drain hose	VP25 [ø25 (I.D.) ; ø32 (O.D.)]			

Note : Specifications are based on the following conditions. Cooling : Indoor temperature of 27°CDB / 19°CWB, and outdoor temperature of 35°CDB / 24°CWB. Heating : Indoor temperature of 20°CDB / (15°CWB), and outdoor temperature of 7°CDB / 6°CWB. Pipe length : 7.5 m; Height difference between outdoor unit and indoor unit : 0 m. Voltage : 230 [V].

Wall Mounted



Model name		ASYA04GACH	ASYA07GACH	ASYA09GACH	ASYA12GACH	ASYA14GACH	ASYE04GACH	ASYE07GACH	ASYE09GACH	ASYE12GACH	ASYE14GACH
Power source		230/1/50									
Capacity	Cooling	1.1	2.2	2.8	3.6	4.5	1.1	2.2	2.8	3.6	4.5
	Heating	1.3	2.8	3.2	4.1	5.0	1.3	2.8	3.2	4.1	5.0
Input power		13	17	18	22	34	12	15	16	21	34
Airflow rate	High	450	490	500	560	670	450	490	500	560	680
	Med	370/440*1	450	450	480	490	370/440*1	450	450	480	490
	Low	320/420*1	370/420*1	370/420*1	420	420	300/420*1	370/420*1	370/420*1	420	420
Sound pressure level	High	33	35	36	39	44	32	34	35	38	43
	Med	27/32*1	33	33	35	37	26/31*1	32	32	34	35
	Low	22/31*1	27/31*1	27/31*1	31	32	19/30*1	26/30*1	26/30*1	30	30
Dimensions (H x W x D)		275 x 790 x 215					275 x 790 x 215				
Weight		9					9				
Connection pipe diameter	Liquid (Flare)	ø6.35					ø6.35				
	Gas (Flare)	ø12.70					ø12.70				
	Drain hose	ø13.8(I.D.) ; ø15.8-ø16.7(O.D.)					ø13.8(I.D.) ; ø15.8-ø16.7(O.D.)				
EV Kit (option)		—					UTR-EV09XB / UTR-EV14XB				

Note : Specifications are based on the following conditions. Cooling : Indoor temperature of 27°CDB / 19°CWB, and outdoor temperature of 35°CDB / 24°CWB. Heating : Indoor temperature of 20°CDB / (15°CWB), and outdoor temperature of 7°CDB / 6°CWB. Pipe length : 7.5 m; Height difference between outdoor unit and indoor unit : 0 m. Voltage : 230 [V]. \*1 : This value is under cooling operation.

Wall Mounted



Model name		ASYA18GACH	ASYA24GACH	ASYA30GACH
Power source		230/1/50		
Capacity	Cooling	5.6	7.1	8.0
	Heating	6.3	8.0	9.0
Input power		32	60	91
Airflow rate	High	840	1,100	1,240
	Med	770	910	980
	Low	690	730	770
Sound pressure level	High	41	48	52
	Med	39	43	45
	Low	35	35	35
Dimensions (H x W x D)		320 x 998 x 228		
Weight		15		
Connection pipe diameter	Liquid (Flare)	ø9.52		
	Gas (Flare)	ø15.88		
	Drain hose	ø12 (I.D.) ; ø16 (O.D.)		

Note : Specifications are based on the following conditions. Cooling : Indoor temperature of 27°CDB / 19°CWB, and outdoor temperature of 35°CDB / 24°CWB. Heating : Indoor temperature of 20°CDB / (15°CWB), and outdoor temperature of 7°CDB / 6°CWB. Pipe length : 7.5 m; Height difference between outdoor unit and indoor unit : 0 m. Voltage : 230 [V].

## Control system overview

User's needs are supported by offering a variety of controls, such as individual control, central control and building management control options.



For All AIRSTAGE™ series

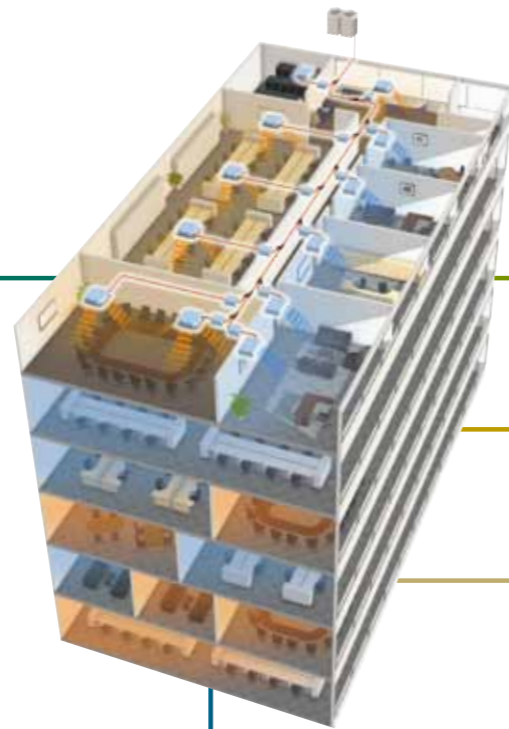

### Air Conditioning Individual Control

- Wired Remote Controller (Touch panel)**  
UTY-RNRY
- Wired Remote Controller**  
**NEW** UTY-RLRY
- Simple Remote Controller**  
UTY-RSKY
- Simple Remote Controller**  
UTY-RHKY  
Without operation mode
- Wireless Remote Controller**  
UTY-LNHY

### Service & Maintenance Tool

#### Web Monitoring System Software

UTY-AMGX

#### Service Tool Software

UTY-ASGX

### Air Conditioning Centralized Control

#### System Controller Software

UTY-APGX  
**NEW** UTY-ALGX (Lite edition)

#### Touch Panel Controller

UTY-DTGY

#### Central Remote Controller

UTY-DCGY

#### Group Remote Controller

UTY-CCGY

Network Converter  
UTY-VGGXZ1

### Converter / Adaptor (for external device)

- BACnet® Gateway Software**  
UTY-ABGX  
USB Adaptor\*2 (Field supplied)
- Network Converter (BMS/LONWORKS®)**  
UTY-VLGX
- KNX® Interface**  
FJ-RC-KNX-1i
- MODBUS® Interface**  
FJ-RC-MBS-1
- Wireless LAN Interface**  
**NEW** FJ-RC-WIFI-1
- External Switch Controller**  
UTY-TEKX  
Card-key (Field supplied)

**BMS/BAS\*1**

**BMS, Home automation system**

Internet device

\*1. BMS/BAS: Building Management System/Building Automation System  
\*2. USB Adaptor: Echelon® U10 USB Network Interface

### Converter / Adaptor (for system expansion)

#### Network Converter

UTY-VGGXZ1

#### Signal Amplifier

UTY-VSGXZ1

Comparison table of Controllers

Item	Wired Remote Controller (Touch panel)	Wired Remote Controller	Simple Remote Controller	Simple Remote Controller*1	Wireless Remote Controller	Group Remote Controller	Central Remote Controller	Touch Panel Controller	System Controller Lite (Software)	System Controller (Software)	
Model name	UTY-RNRY	UTY-RLRY	UTY-RSKY	UTY-RHKY	UTY-LNHY	UTY-CGGY	UTY-DCGY	UTY-DTGY	UTY-ALGX	UTY-APGX	
Max. controllable remote controller groups	1	1	1	1	1	8	100	400	400	1600	
Max. controllable indoor units	16	16	16	16	16	128	100	400	400	1600	
Max. controllable groups	—	—	—	—	—	—	16	400	400	1600	
Air conditioning control function	On / Off	●	●	●	●	●	●	●	●	●	
	Operation mode setting	●	●	●	—	●	●	●	●	●	
	Fan speed setting	●	●	●	●	●	●	●	●	●	
	Room temp. setting	●	●	●	●	●	●	●	●	●	
	Room temp. set point limitation	●	●	—	—	—	—	●	●	●	
	Test operation	●	●	●	—	●	—	●	●	—	
	Up/down air direction flap setting	●	●	—	—	●	—	●	●	●	
	Right/left air direction flap setting	●	●	—	—	●	—	●	●	●	
	Group setting	—	—	—	—	—	—	●	●	●	
	RC prohibition	—	—	—	—	—	—	●	●	●	
	Anti freeze setting	●	—	—	—	—	—	●	●	●	
	Economy mode setting	●	●	—	—	●	—	●	●	●	
Display	Failure	●	●	●	●	—	●	●	●	●	
	Defrosting	●	●	●	●	—	—	●	●	●	
	Current time	●	●	—	—	●	●	●	●	●	
	Day of week	●	●	—	—	—	—	●	●	●	
	R.C. prohibition	●	●	●	●	—	—	●	●	●	
	Cooling/heating priority	●	●	●	●	—	—	●	●	●	
	Address display	●	●	●	●	—	—	●	●	●	
	Room temp	●	—	—	—	—	—	—	—	—	
	Multi language	●	—	—	—	—	—	●	●	●	
	Summer time	●	—	—	—	—	—	●	●	●	
	Name registration	●	—	—	—	—	—	●	●	●	
	Backlight	●	—	●	●	—	—	●	●	—	
2D floor layout / 3D building display	—	—	—	—	—	—	—	—	●		
Timer	Schedule timer	Period	Week	Week	—	—	Week	Week	Year	Year	Year
		On/off, Temp, Mode, Times per day	8	4	—	—	4	20	20	144	144
	On/off timer	●	●	—	—	●	—	—	—	—	
	Sleep timer	—	—	—	—	●	—	—	—	—	
	Program timer	—	—	—	—	●	—	—	—	—	
	Auto off timer	●	●	—	—	—	—	—	—	—	
	Day off	●	●	—	—	—	—	●	●	●	
Min. unit of timer setting (Minutes)	10 • 30	30	30	30	5	10	10	10	10	10	
Control	Status monitoring system	—	—	—	—	—	—	●	●	●	
	Electricity charge apportionment	—	—	—	—	—	—	—	○	●	
	Error history	●	●	●	●	—	●	●	●	●	
	Emergency stop	—	—	—	—	—	—	●*2	●*2	—	
	Remote management	—	—	—	—	—	—	—	○	●	
	Energy saving management	—	—	—	—	—	—	—	○	○	
	E-mail notification for malfunction	—	—	—	—	—	—	—	●	●	
Key lock	●	●	—	—	—	●	●	●	●	●	
	Child lock	Child lock	—	—	—	Child lock	Password setting	Password setting	Password setting	Password setting	

\*1 "Operation mode" setting is not available for this model.  
\*2 This function is available only through external input control.

● : Supported ○ : Optional function  
— : Not supported yet

## Wired Remote Controller (Touch Panel) : UTY-RNRY

Easy operation by high-definition large STN-LCD touch panel screen

- Easy finger touch operation with LCD panel
- Built-in weekly/Daily timer(ON/OFF,Temp.,Mode)
- Backlight enables easy operation in a darkened room
- Room temperature display
- Control up to 16 indoor units
- Corresponds to 7 different languages (English, Chinese, French, German, Spanish, Russian, Polish)
- 2-wire type



Max. controllable  
16  
Indoor units

## High performance and compact size

In addition to the individual control, weekly timer, and various energy saving controls can be realized using one remote controller only.



## Accurate and comfortable control

Indoor temperature can be detected accurately by the inclusion of a thermo sensor in the body of the wired controller.



Room temperature sensor

Room temperature display

## Various energy saving control

### Auto OFF timer

- The indoor unit automatically is turned off when it reaches to the preset operating time frame.
- The time frame of the "Auto off timer" can be flexibly scheduled.
- Can be set off time 30 to 240 minutes

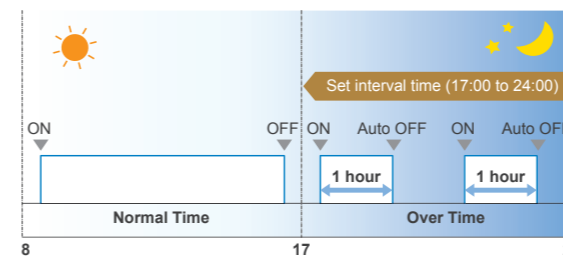

Ex.) At interval time hour (17:00 to 24:00) to prevent forgetting to turn off  
Set off time : 1 hour

### 2 schedules Weekly Timer

- 2 schedules such as for the summer and winter can be set.
- 8 setting changeable per day of week (Setting items: On/Off, Temperature, Mode, Time)

Schedule 1 (Summer schedule)

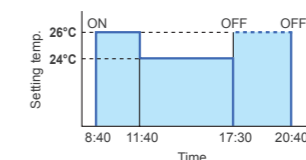

Schedule 2 (Winter schedule)

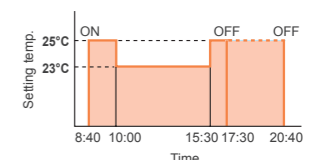

### Set Temperature Auto Return

The setting temperature automatically returns to the previous setting temperature. The time range in which the set temperature can be changed is 10 to 120 minutes.

### Set Temperature Upper and Lower Limit Setting

The set temperature range can be set for each operation mode. (Cooling / Heating / Auto)

## Specifications

Model name	UTY-RNRY
Power Source	DC 12 V
Dimensions (H x W x D) (mm)	120 x 120 x 20.4
Weight (g)	220

DC12 V is supplied by the indoor unit.



Max. controllable  
**16**  
Indoor units

## NEW Wired Remote Controller : UTY-RLRY

- Various timer setup (ON / OFF / WEEKLY) are possible.
- The room temperature can be controlled by detecting the temperature accurately with Built-in thermo sensor.
- When a failure occurs, the error code is displayed.
- Error history. (Last 16 error codes can be accessed.)
- 2-wire type



## High performance and compact size

In addition to the individual control, weekly timer, and various energy saving controls can be realized using only one remote controller.



## Auto-off timer

- The indoor unit automatically turns off after a set time has passed.

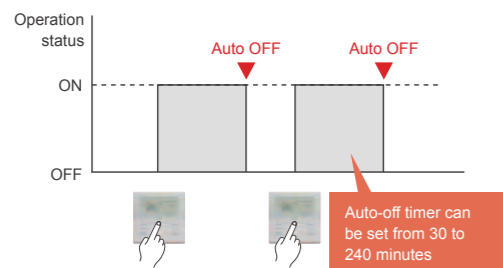

## High visibility and easy operation

- "Mode", "Set Temp", and "Fan" are displayed at large size on the top screen.
- Each function to be set is indicated by an icon.
- Control guide is displayed and operation is simple and straightforward.

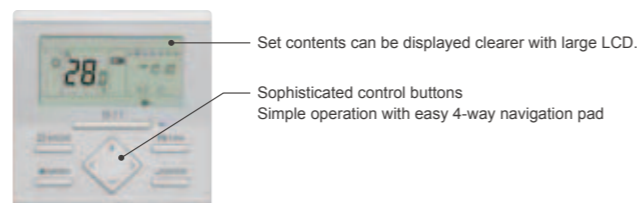

## Set temperature auto return

- The setting temperature automatically returns to the previously set temperature.
- The time range in which the set temperature can be changed is 30 to 120 minutes.

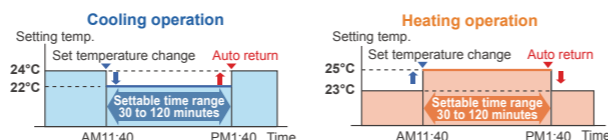

## Weekly timer function

- Not only time setting On / Off, but also setting of the operation mode and set temperature can be set by Weekly timer function.

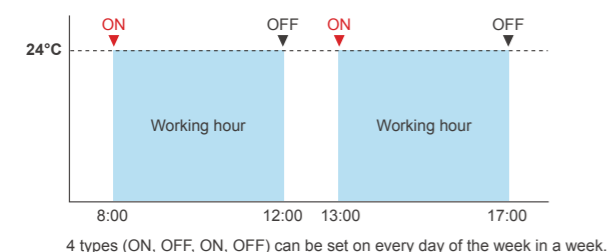

## Set temperature upper and lower limit setting

- The set temperature range can be set for each operation mode. (Cooling / Heating / Auto)

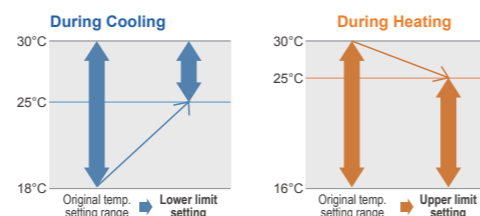

## Specifications

Model name	UTY-RLRY
Power supply	DC 12V
Dimension (H x W x D) (mm)	120 x 120 x 17
Weight (g)	170

\* DC12V is supplied by indoor unit.

Max. controllable  
**16**  
Indoor units

## Simple Remote Controller :

UTY-RSKY / UTY-RHKY (Without operation mode)

Compact remote controller provides access to basic functions

- Up to 16 indoor units can be controlled with one remote controller.
- Suitable for hotels or offices as it is easily operated with no complex functions.
- 3-wire type



Without operation mode

## Easy-to-use operation

- Provides access to basic operations, such as Start / Stop, Fan control, Operation mode switching, and Room temperature setting.
- A large On / Off button is provided in the centre of the remote controller for easy operation.
- Can be used jointly with other individual control unit.
- Following an error display, diagnostics can be carried out on the controller.

## Simple installation

Can be mounted on the European Mounting Box (Installation dimension: 60mm) or the JIS Built-in Box (Installation dimension: 83.5mm).



## Backlight

- Backlight enables easy operation in a darkened room.
- Backlight activates during all button operations, and lasts 10 seconds in Operation mode and 5 seconds in stop mode after a button is pressed.



## Functions

Model	UTY-RSKY	UTY-RHKY
Operation	●	●
On / Off	●	●
Fan control	●	●
Operation mode	●	— *1
Room temp. setting	●	●

\*1: "Operation mode" setting is not available. It is recommend to use together with other type controller.

## Specifications

Model name	UTY-RSKY	UTY-RHKY
Power Source	DC 12 V	DC 12 V
Dimensions (H x W x D) (mm)	120 x 75 x 14	120 x 75 x 14
Weight (g)	90	90

DC12 V is supplied by the indoor unit.

### Wireless Remote Controller : UTY-LNHY



Simple and sophisticated operations with a choice of 4 daily timers

- A single controller controls up to 16 indoor units.

Max. controllable  
**16**  
 Indoor units

Selectable  
**4**  
 daily timers

### Built-in timers

#### Select from 4 different timer programs:

On / Off / Program / Sleep

**Program timer:** The program timer operates the ON and OFF timer once within a 24 hour period.

**Sleep timer:** The sleep timer function automatically corrects the set temperature according to the time setting to prevent excessive cooling or heating during sleep hours.

### Easy installation and operation

•Code selector switch prevents indoor unit mix-up. (Up to 4 codes can be set.)

•Wide and precise transmitting range.

### System addressing

During installation work, system addressing can be performed using the Wireless Remote Controller, thus eliminating manual switch setting.

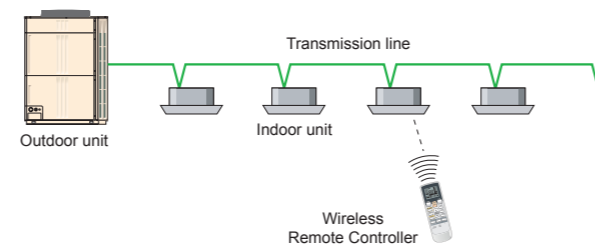

### IR Receiver Unit : UTB-YWC

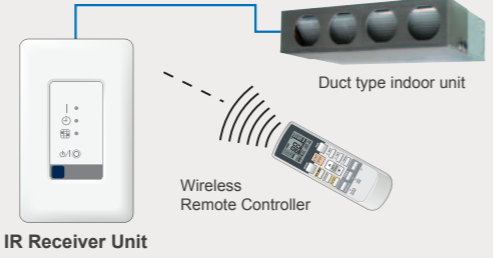

Necessary to control for all duct type by Wireless Remote Controller

### IR Receiver Unit : UTY-LRHYB1

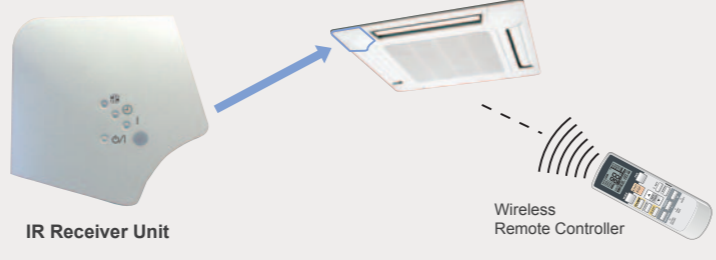

Cassette type indoor unit can be controlled with Wireless Remote Controller

### Specifications

Model name	UTY-LNHY	UTB-YWC	UTY-LRHYB1
Battery	1.5 V (R03 / LR03 / AAA) x 2	DC 12 V	DC 12 V
Dimensions (H x W x D) (mm)	170 x 56 x 19	145 x 90 x 30	193.9 x 193.9 x 31.2
Weight (g)	85	150	140

DC12 V is supplied by the indoor unit.

### Group Remote Controller : UTY-CGGY

Group control of indoor units with simple operation

- Up to 8 remote controller groups can be controlled by one Group Remote Controller.
- Up to 64 Group Remote Controllers can be connected in one VRF network system.
- Network Converter is required to connect Group Remote Controllers to a VRF network system. (Network Converter allows up to 4 Group Remote Controllers)
- 3-wire type

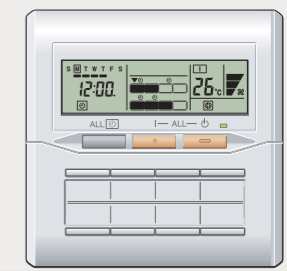

Max. controllable  
**64**  
 group R.C.  
 in a VRF  
 network system

Max. controllable  
**8**  
 remote  
 controller groups

### Control up to 8 remote controller groups

•Single Group Remote Controller controls and monitors up to 8 remote controller groups.

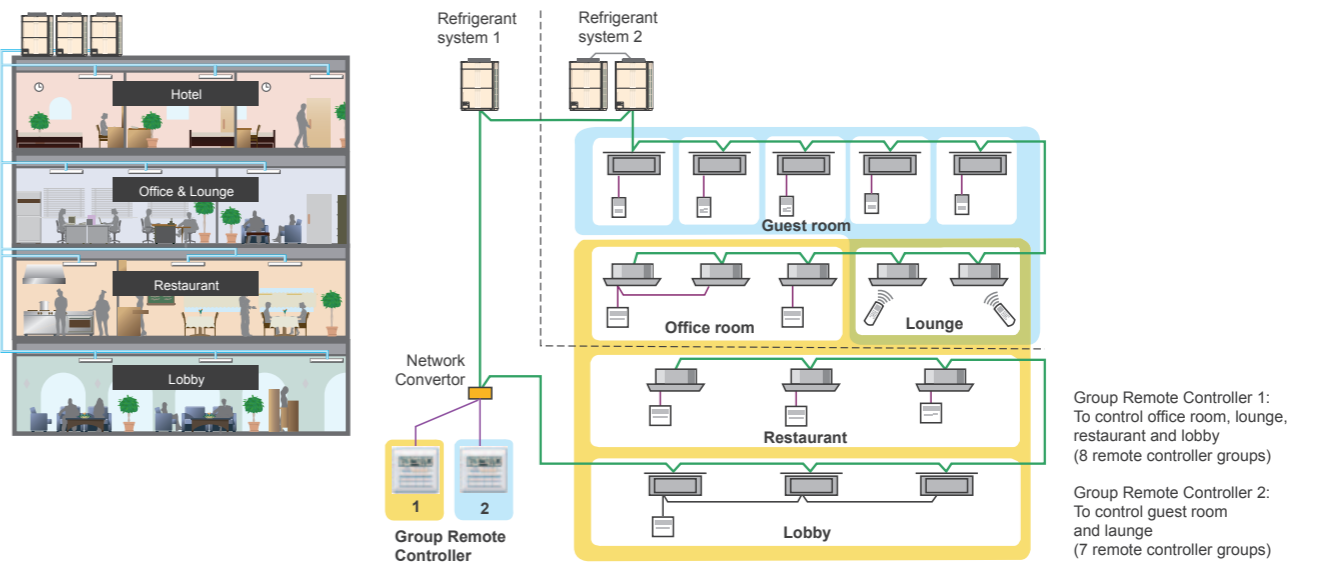

### High performance and compact size

ON / OFF, Operating mode, Room temperature and Fan speed setting can be controlled / monitored centrally or individually.



### Built-in weekly timers

The weekly timer is provided as a standard function.

1. The timer can be set up for up to 4 times per day. (On / Off, operating mode, set temperature)
2. Allows separate settings for each day of the week.

### Specifications

Model name	UTY-CGGY
Power Supply	DC 12 V
Dimensions (H x W x D) (mm)	120 x 120 x 18
Weight (g)	200

DC12 V is supplied by the indoor unit.

## Central Remote Controller : UTY-DCGY

Central Remote Controller fits small- and medium-sized buildings and tenants.

- Individual control and monitor of 100 indoor units
- 5 inch TFT color screen
- High visibility and easy operation
- External input / output contact
- Detachable power supply unit
- Corresponds to 7 different languages like English, Chinese, French, German, Spanish, Russian, Polish.
- 2-wire type



Max. controllable  
100  
Indoor units

Max. controllable  
16  
groups

## System overview

- It allows multiple indoor units grouping (Max.16 groups controlled)
- Interlock with external device

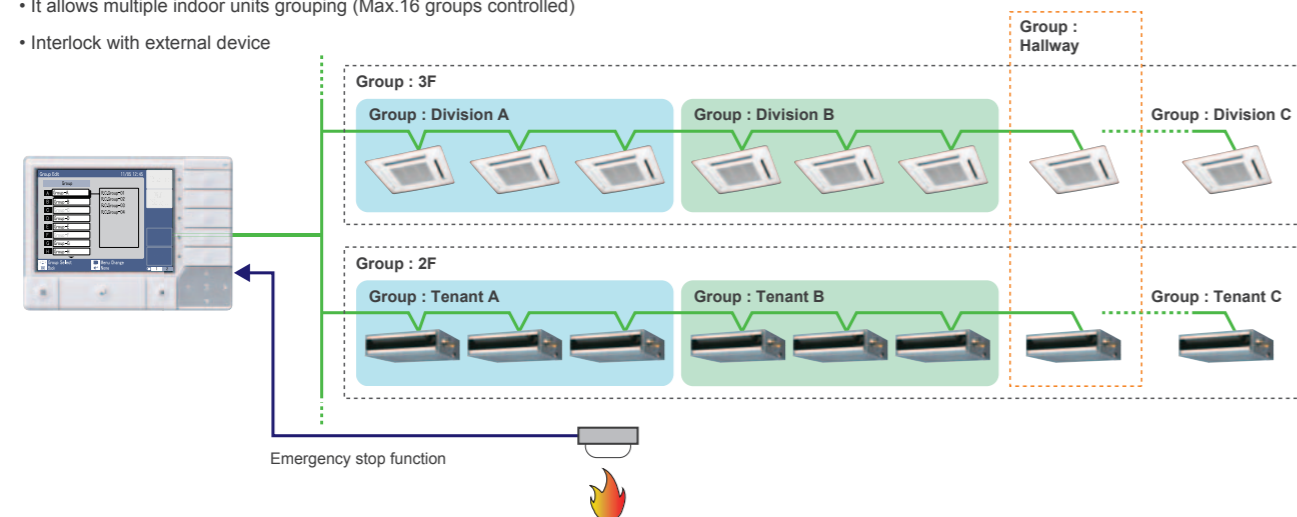

## Easy Installation

- The control panel and power supply unit can be installed separately.
- For flexibility in installation, the Control panel can be built into the wall or fix on the wall.

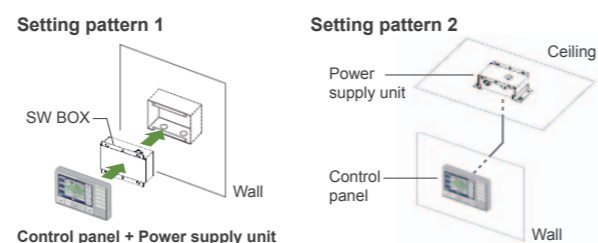

## Functions

- Diverse control of indoor units
- Weekly timer
- Automatic clock adjustment
- Error history

## Specifications

Model name	UTY-DCGY	
	Control Panel	Power Supply Unit
Power Supply	DC 5 V	100-240 V, 50-60Hz, Single phase
Dimensions (H x W x D) (mm)	120 x 162 x 25.7	99 x 135 x 39.2
Weight (g)	308	355

### <PACKING LIST>

Packing List	Control Panel / Power Supply Unit / Connecting cable, etc.
--------------	--

## Touch Panel Controller : UTY-DTGY

- Large-sized 7.5-inch TFT color
- LCD Easy finger touch operation
- Stylish shape and design to suit all application
- No additional component is required for installation
- Up to 400 indoor units can be controlled
- Selectable 2 display types (Icon / List) in monitoring mode
- Corresponds to 7 different languages, English, Chinese, French, German, Spanish, Russian, Polish.
- 2-wire type



Max. controllable  
400  
Indoor units

## Easy operation

- Wide range of simple-to-understand icons
- Operation can be selected using your finger or the dedicated touch pen by pressing the appropriate on-screen icon
- Up-to-date status display
- Background color identifies current control operation blue for monitoring, green for operational control

## Functions



## Automatic clock adjustment

The time setting of each controller can be set in batch automatically.

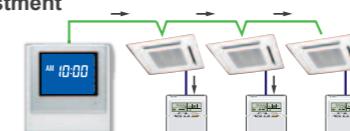

## Versatility

- **Emergency stop function:** Air conditioner can be turned off through the external input control
- The stored data can be transferred via USB port
- CSV format data edited by PC can be imported to Touch Panel Controller.

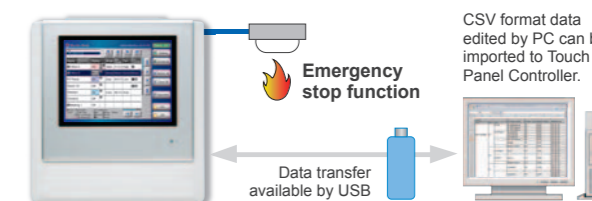

## Easy installation

- Touch Panel Controller is easily mounted to the wall.
- Flat back surface allows to be installed wherever it is needed.
- No additional component is required for installation.



## Specifications

Model name	UTY-DTGY
Power Supply	100-240 V 50/60Hz, Single phase
Dimensions (H x W x D) (mm)	260 x 246 x 54
Weight (g)	2,150
Interface	USB 2.0

## System Controller : UTY-APGX Software

System Controller realizes the advanced integrated monitoring & control of VRF network system from small scale buildings to large scale buildings.

- Up to a maximum of 4 VRF network systems, 1600 indoor units, and 400 outdoor units can be controlled.
- In addition to air conditioning precision control function, central remote control, electricity charge calculation, schedule management, and energy saving functions are strengthened and building manager and owner needs are met.
- Corresponds to 7 different languages (English, Chinese, French, German, Spanish, Russian, Polish)

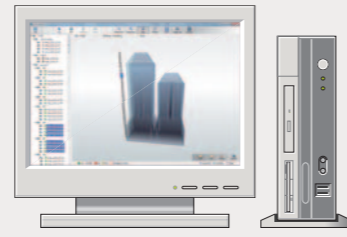

Max. controllable  
**4**  
VRF network systems

Max. controllable  
**400**  
outdoor units

Max. controllable  
**1,600**  
indoor units

## System Controller Lite : UTY-ALGX Software **NEW**

System Controller Lite has standard functions sufficient for air conditioner management in small and medium scale buildings .

- Up to a maximum of 1 VRF network system, 400 indoor units, and 100 outdoor units can be controlled.
- In addition to air conditioning precision control function, a variety of management software is available as an option to give customers a wide range of choice.
- Corresponds to 7 different languages (English, Chinese, French, German, Spanish, Russian, Polish)



Max. controllable  
**1**  
VRF network systems

Max. controllable  
**100**  
outdoor units

Max. controllable  
**400**  
indoor units

## High visibility and Easy operation

- **Click & Operate** : The property is shown visually from the perspective most suitable for operation and operated accordingly (Click & Operate). You can select from among the 4 displays of site, building, floor, or list.
- **Freely define groups for batched control** : Indoor units can be freely grouped for simple batched control from a tree menu. Grouping by hierarchical structure, such as by section, division or department is possible.

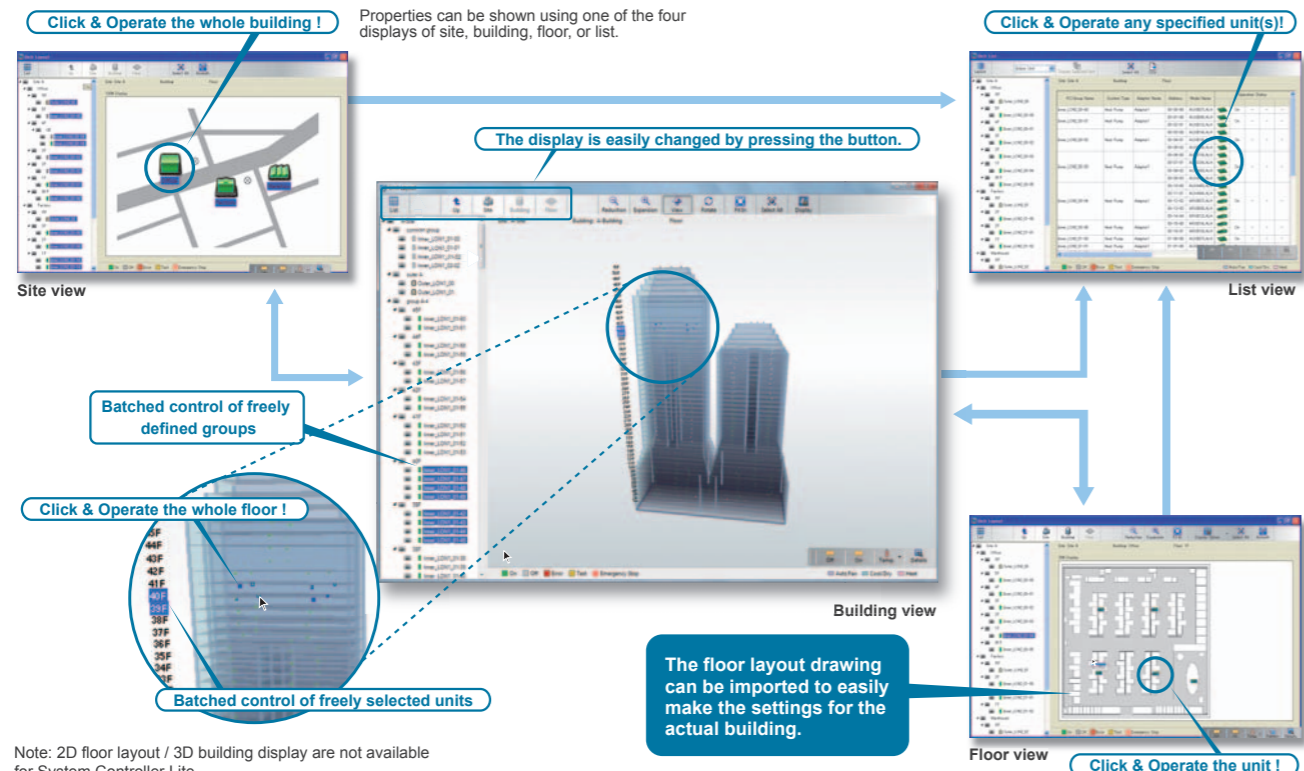

Note: 2D floor layout / 3D building display are not available for System Controller Lite.

## Diverse operation management & Data management Standard for System Controller and System Controller Lite

### Schedule management

- Annual schedules can be set for each remote controller group / user defined group.
- Start / stop, operating mode, remote controller prohibition, and temperature settings can be set up to 143 times per day at 10 minute intervals for up to 101 configurations for each remote controller group.
- Settings can be made for periods straddling midnight.
- Allows programming of special settings for holidays, including public holidays, for a complete year.
- Low noise operation of outdoor unit can be scheduled.



### Error display & E-mail notification

Error is notified with popup message, audible sound and E-mail real time when error occurs. Error for the past 1 year are logged and can be reviewed later.

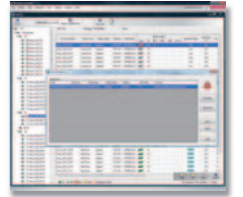

### Operating & control record

Displays the history of operation status and control.

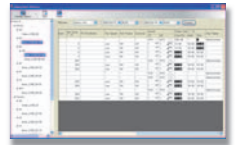

### Diverse control of indoor unit

- Indoor unit operation state, operation mode, etc. are displayed
- Indoor unit start / stop and operation mode switching
- Room temperature set point limitation



### Remote controller prohibition

This prohibits changes to the operation mode, temperature, start/stop, etc.



### Automatic clock adjustment

The time setting of each controller can be set in batch automatically.

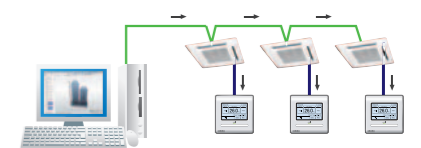

## Electricity charge apportionment Standard for System Controller Option for System Controller Lite UTY-PLGXA1

Electricity charge apportionment calculation framework  
Suppose you want to find the power consumed by the air conditioners of each tenant from the electricity charge for each month. With electricity charge apportionment function, used energy apportionment ratio will be provided, calculating in detail the energy consumed by the units used by each tenant. This information is then used to calculate the charges for the electricity consumed for air conditioning by each tenant from the total electricity charges in the bill from the electric power company. (See figure at right)  
The detailed calculation takes into consideration such things as unused rooms and nighttime electricity charges and shows them in a charges calculation sheet.

### System Configuration Example

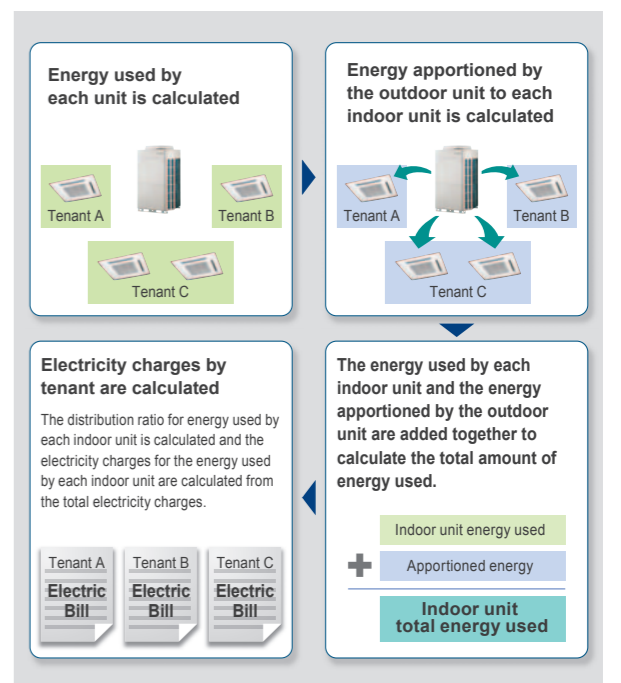
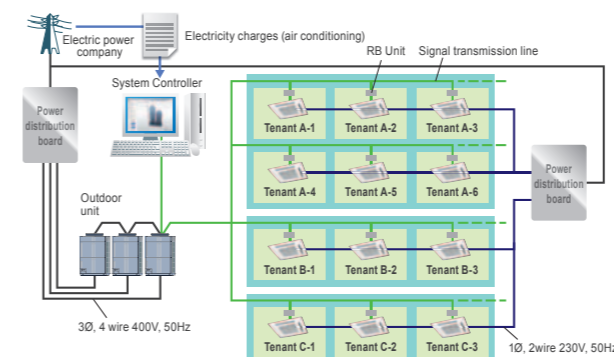

## Remote management Standard for System Controller Option for System Controller Lite UTY-PLGX1

System Controller may be used on site or remotely over various networks for remote central control. System Controller requires 2 softwares working together. VRF Controller runs on site and communicates with VRF system. VRF Explorer runs remotely and provides user interface and communicates with the VRF Controller. VRF Controller and VRF Explorer program may run in a single PC or in different PCs separated by network. By using VRF Explorer software, one PC can perform central control of 10 VRF system sites with max. 20 buildings per site.

### On site central control

Max. 4 VRF network systems per site

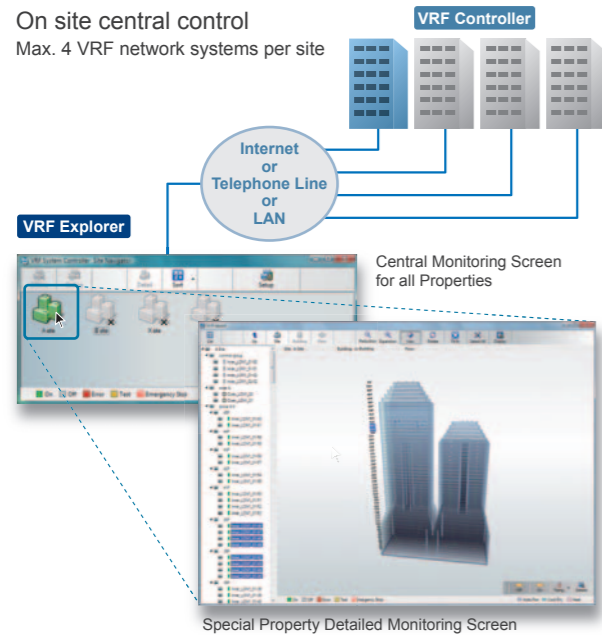

### Remote central control

1 VRF Explorer can control or monitor up to 10 sites.

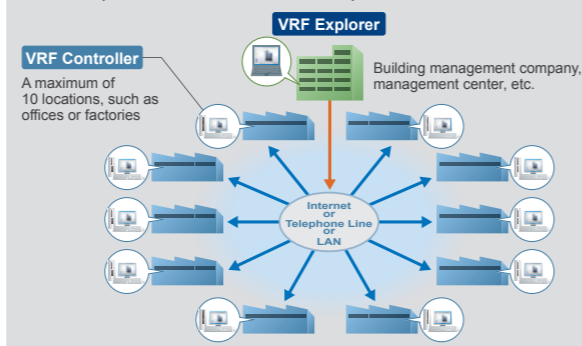

1 VRF Controller can be monitored from any number of VRF Explorers (Up to 5 connections simultaneously).

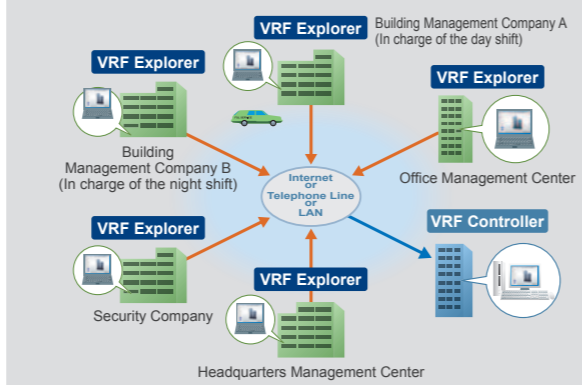

## Energy saving management Option for System Controller UTY-PEGX Option for System Controller Lite UTY-PLGX1

A variety of energy saving operations can be set and managed depending on the season, weather, and time period. Excellent energy saving operation is performed while keeping users comfortable.

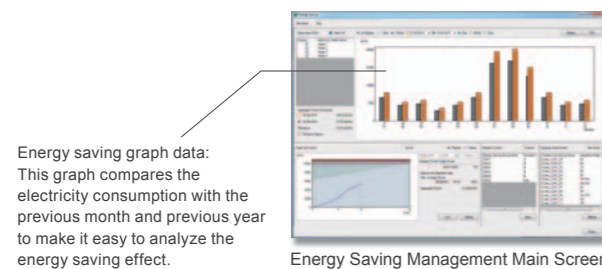

### Peak cut operation

A power meter is connected to detect the total power consumption while shifting the indoor unit set temperature, set the indoor unit forced thermostat off, and taking other measures to carefully control the power consumed while maintaining comfort and conducting control to maintain the target power consumption set for each time. The indoor units to be controlled can be freely grouped and the control level can be set.

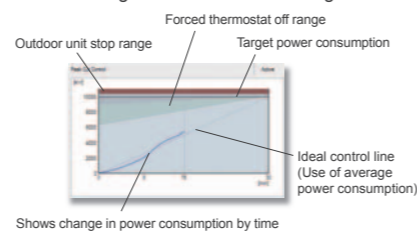

### Indoor unit rotation operation

The operation of indoor units can be automatically rotated within a group in accordance with the set annual schedule to reduce power consumption while maintaining comfort. The indoor unit operation stoppage rate can be selected.



### Outdoor unit capacity save

Outdoor unit capacity save switches the outdoor unit capability upper limit to suppress power consumption during hot summers and cold winters by averaging the power saving effect of each refrigerant system. You can select from 50% or more of the capacity upper limit.

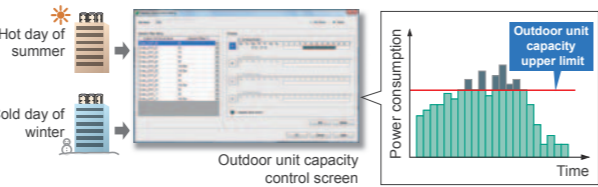

## FUNCTIONS SUMMARY

Function	Type	System controller		System controller lite			
		UTY-APGX	<span style="border: 1px solid black; border-radius: 50%; padding: 2px;">Option</span> UTY-PEGX	UTY-ALGX	<span style="border: 1px solid black; border-radius: 50%; padding: 2px;">Option</span> UTY-PLGX1	<span style="border: 1px solid black; border-radius: 50%; padding: 2px;">Option</span> UTY-PLGX1	<span style="border: 1px solid black; border-radius: 50%; padding: 2px;">Option</span> UTY-PLGX1
System specification	Max. VRF networks supported	4	-	1	-	-	
	Max. indoor unit / remote controller groups per VRF network	400	-	400	-	-	
	Max. outdoor units per System controller	100	-	100	-	-	
	Max. indoor units / remote controller groups per System controller	1600	-	400	-	-	
	Max. outdoor units per System controller	400	-	100	-	-	
Site supervision	Multi site display	10	-	10	-	-	
	Number of building / 1 site	20	-	-	-	-	
	Number of floor per 1 site	200	-	-	-	-	
	Number of floor per 1 building	50	-	-	-	-	
	3D graphical layout view	○	-	-	-	-	
	2D graphical layout view	○	-	-	-	-	
	List display	○	-	○	-	-	
	Tree display	○	-	○	-	-	
	Group display	○	-	○	-	-	
	Error management	Error notification	○	-	○	-	-
History	Audible alarm	○	-	○	-	-	
	Error e-mail notification	○	-	○	-	-	
Operation control	Individual control	Error history	○	-	○	-	-
		Operation history	○	-	○	-	-
		Control history	○	-	○	-	-
		On/Off	○	-	○	-	-
		Operation mode	○	-	○	-	-
		Room temperature	○	-	○	-	-
		Fan speed	○	-	○	-	-
		Air flow direction	○	-	○	-	-
		Economy mode	○	-	○	-	-
		Room temperature set point limitation	○	-	○	-	-
	Test operation	○	-	○	-	-	
	Antifreeze	○	-	○	-	-	
	Individual management	Remote control prohibition setting	○	-	○	-	-
		Temperature upper and lower limit setting	○	-	○	-	-
		Filter sign reset	○	-	○	-	-
Other	Memory operation	○	-	○	-	-	
	Pattern operation	○	-	○	-	-	
Schedule	Annual Schedule	○	-	○	-	-	
	Special day setting	○	-	○	-	-	
	On / off per day	72	-	72	-	-	
	On / off per week	504	-	504	-	-	
	Day off	○	-	○	-	-	
	Min. unit of timer setting (Minutes)	10	-	10	-	-	
Remote management	Low noise mode Weekly schedule	○	-	○	-	-	
	Remote monitoring	○	-	○	-	-	
	Remote operation control	○	-	○	-	-	
	Remote function setting	○	-	○	-	-	
Electricity charge apportionment	Apportionment charge/bill calculation	○	-	○	-	-	
	Tenant (block) setting	○	-	○	-	-	
	Common facilities apportionment setting	○	-	○	-	-	
	Rated power consumption allotment setting	○	-	○	-	-	
	Individual calculation at cooling and heating	-	○*	-	○	-	
	Electricity meter supported	-	○	-	○	-	
Energy saving management	Indoor unit rotation	-	○	-	○	-	
	Peak cut control	-	○	-	○	-	
	Outdoor unit capacity save	-	○	-	○	-	
	Record of energy saving operation	-	○	-	○	-	
	Energy saving information	-	○	-	○	-	
	Power consumption monitor	-	○	-	○	-	
	Electricity meter supported	-	○	-	○	-	
Others	Database import/export	○	-	○	-	-	
	Automatic clock adjustment	○	-	○	-	-	
	Multi language	7 languages	-	7 languages	-	-	

○ : Available. - : Not available.

\*:Power calculation application software is necessary, please contact the local FGL representative.

### Personal computer system requirements

Operating system	<ul style="list-style-type: none"> <li>Microsoft® Windows Vista® Home Premium (32-bit) SP2, Windows Vista® Business (32-bit) SP2</li> <li>Microsoft® Windows® 7 Home Premium (32-bit or 64-bit) SP1, Windows® 7 Professional (32-bit or 64-bit) SP1</li> <li>Microsoft® Windows® 8 (32-bit or 64-bit), Windows® 8 Pro (32-bit or 64-bit)</li> <li>Microsoft® Windows® 8.1 (32-bit or 64-bit), Windows® 8.1 Pro (32-bit or 64-bit)</li> </ul> [Supported languages] English, Chinese, French, German, Russian, Spanish, and Polish
CPU	Intel® Core™ i3 2 GHz or higher
Memory	<ul style="list-style-type: none"> <li>For Windows Vista® and Windows® 7 (32-bit): 2 GB or more</li> <li>For Windows® 7 (64-bit), Windows® 8, and Windows® 8.1: 4 GB or more</li> </ul>
HDD	40 GB or more of free space
Display	1024 x 768 or higher resolution
Interface	USB port is required for each of the followings for Server PC ; <ul style="list-style-type: none"> <li>Wibu Key (Software protection key)</li> <li>Echelon® U10 USB Network Interface (Required for each VRF Network)</li> </ul> Ethernet port is required for remote connection using internet.
Accelerator	Microsoft® DirectX® 9.0c compatible
Software	Adobe® Reader® 9.0 or later
Optical drive	DVD-ROM drive

Personal computer must be field supplied.

U10 USB Network Interface must be field supplied. Contact Echelon® Corporation or its local sales representative for detail.

Product Name : U10 USB Network Interface - TP/FT-10 Channel Model Number : 75010R

### PACKING LIST

Type	For System controller			For System controller Lite		
	System Controller	<span style="border: 1px solid black; border-radius: 50%; padding: 2px;">Option</span> Energy manager	System Controller Lite	Remote access	<span style="border: 1px solid black; border-radius: 50%; padding: 2px;">Option</span> Electricity charge apportionment	<span style="border: 1px solid black; border-radius: 50%; padding: 2px;">Option</span> Energy saving
Model name	UTY-APGX	UTY-PEGX	UTY-ALGX	UTY-PLGX1	UTY-PLGX1	UTY-PLGX1
DVD-ROM	1	1	1	-	-	-
WibuKey*1 (Software protection key)	1	1	1	1	1	1

\*1: Software protection key to be inserted in a USB slot running System Controller or System Controller Lite.

System Controller or System Controller Lite may only run on a PC with Wibu Key. However, WibuKey is not required for remote VRF Explorer software.

## BACnet® Gateway : UTY-ABGX Software

- It is possible to connect medium to large sized BMS to VRF network system via BACnet®, a global standard for open networks.
- A maximum of 1600 indoor units with 4 VRF network systems (a maximum of 400 indoor units & 100 outdoor units for one network system) can be connected to one BACnet® Gateway.
- It is possible to control or monitor VRF network system from BMS via BACnet® Gateway.
- Compatible with BACnet® (ANSI / ASHRAE-135-2004) application specific controller (B-ASC).
- Compatible with BACnet®/IP over Ethernet.
- Scheduling function, Alarm & Event functions as well as Electricity Change Apportionment function are provided in BACnet® Gateway.
- Connection between VRF network system to personal computer is possible via small U10 USB interface. However, both U10 USB interface & personal computer are field supplied items.
- Corresponds to 7 different languages, English, Chinese, French, German, Spanish, Russian, Polish.



BACnet is a registered trademark of ASHRAE. ASHRAE does not endorse, approve or test products for compliance with ASHRAE standards. Compliance of listed products to requirements of ASHRAE Standard 135 is the responsibility of the BACnet International. BTL is a registered trademark of the BACnet International.

Max. controllable  
**4**  
VRF network systems

Max. controllable  
**400**  
outdoor units

Max. controllable  
**1,600**  
indoor units

## Installation example

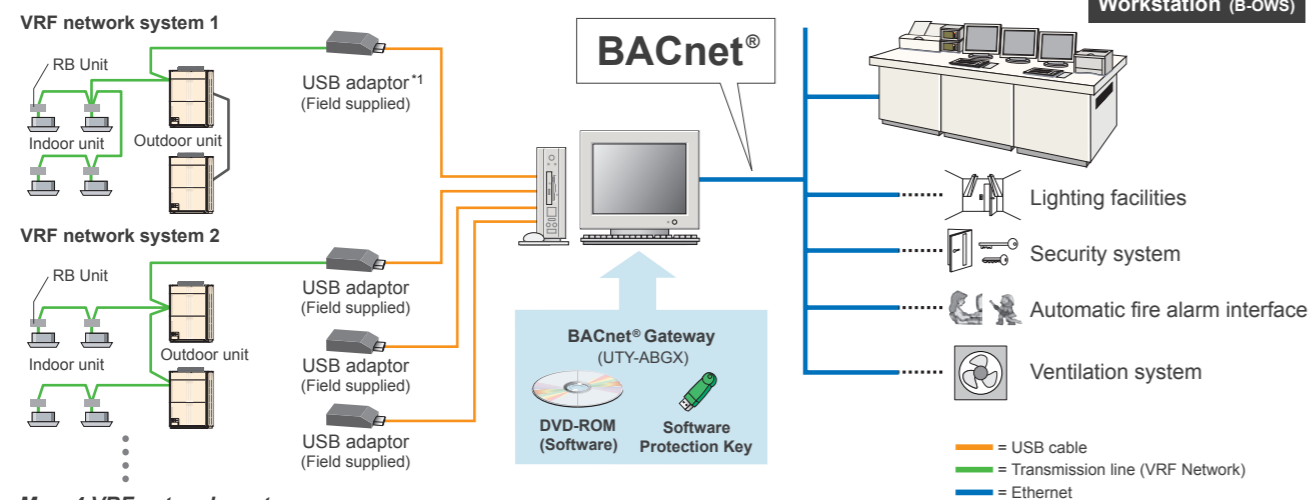

Max. 4 VRF network systems

\*1: USB adaptor is U10 USB Network Interface of Echelon® Corporation.

## Personal computer system requirements

	UTY-ABGX
Operating system	<ul style="list-style-type: none"> <li>• Microsoft® Windows Vista® Home Premium (32-bit) SP2, Windows Vista® Business (32-bit) SP2</li> <li>• Microsoft® Windows® 7 Home Premium (32-bit or 64-bit) SP1, Windows® 7 Professional (32-bit or 64-bit) SP1</li> <li>• Microsoft® Windows® 8 (32-bit or 64-bit), Windows® 8 Pro (32-bit or 64-bit)</li> <li>• Microsoft® Windows® 8.1 (32-bit or 64-bit), Windows® 8.1 Pro (32-bit or 64-bit)</li> </ul> [Supported languages] English, Chinese, French, German, Russian, Spanish, and Polish
CPU	Intel® Core™ i3 2 GHz or higher
Memory	<ul style="list-style-type: none"> <li>• For Windows Vista® and Windows® 7 (32-bit): 2 GB or more</li> <li>• For Windows® 7 (64-bit), Windows® 8, and Windows® 8.1: 4 GB or more</li> </ul>
HDD	40 GB or more of free space
Display	1024 x 768 or higher resolution
Interface	<ul style="list-style-type: none"> <li>• Ethernet port (for getting access to the Internet using LAN)</li> <li>• USB ports (Maximum of 5 ports)</li> <li>- 1 USB port is required for WibuKey connection</li> <li>- Maximum of 4 USB ports are required for Echelon® U10 USB Network Interface</li> </ul> * Required maximum USB port numbers depend on the applicable system configurations.
Software	Adobe® Reader® 9.0 or later
Optical drive	DVD-ROM drive

## <Packing list>

Name and shape	Quantity	Application
DVD-ROM	1	Includes the software and manuals for BACnet® Gateway.
WibuKey (Software protection key)	1	Software protection key to be connected to USB port on the BACnet®-installed PC. BACnet® Gateway runs only on a PC with WibuKey.

Personal computer must be field supplied.  
 U10 USB Network Interface must be field supplied. Contact Echelon® Corporation or its local sales representative for detail.  
 Product Name : U10 USB Network Interface - TP/FT-10 Channel Model Number : 75010R

## Network Converter for LONWORKS® : UTY-VLGX

- For connection between VRF network system and a LONWORKS® open network for management of small to medium-sized BMS and VRF network system.
- The UTY-VLGX permits central monitoring and control of a VRF network system from a BMS through a LONWORKS® interface.
- Up to 128 Indoor units can be connected to one Network Converter for LONWORKS®

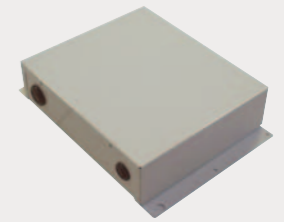

Max. controllable  
**4**  
units to BMS

Max. controllable  
**128**  
indoor units

## Installation example

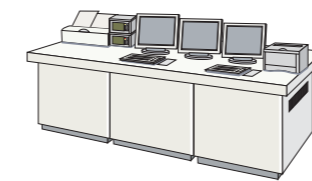

General-purpose building control computer (LONWORKS® device)

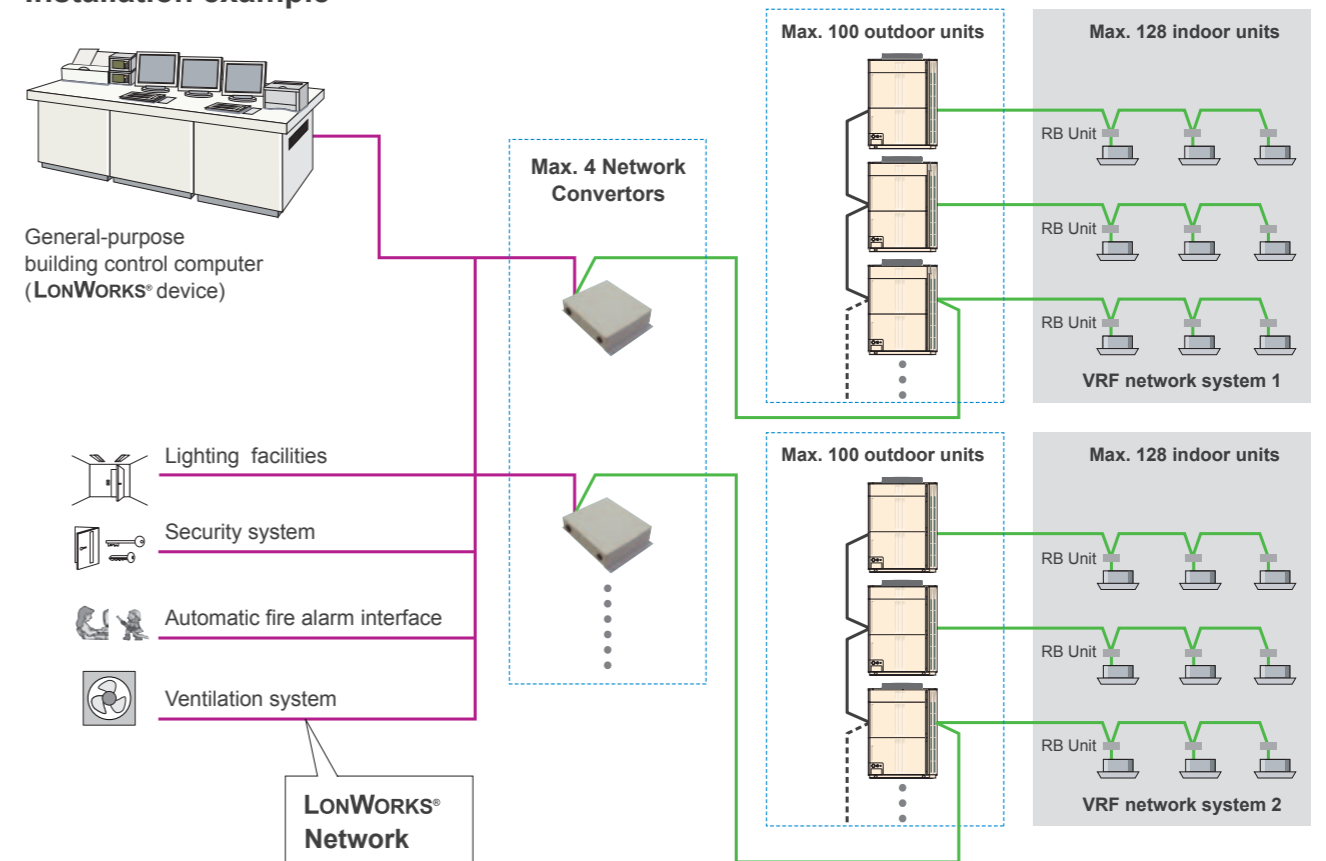

## Specifications

Model name	UTY-VLGX
Power Supply	208-240V 50/60Hz, Single phase
Power Consumption (W)	4.5
Dimensions (H x W x D) (mm)	67 x 288 x 211
Weight (g)	1,500

## Transmission specifications (BMS side)

Transmission speed	78 kbps
Transceiver	FT-X1 (Echelon® Corporation)
Transmission way form	Free topology
Terminal resistor	None (It attaches at the terminal of a network.)

## Dimensions (Unit : mm)

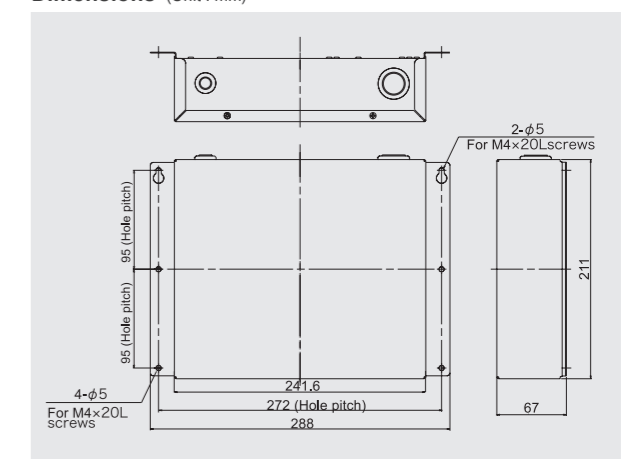

## KNX® Interface : FJ-RC-KNX-1i

The KNX Interface allows a complete integration of air conditioners with KNX Network systems.

- Simple installation due to small and compact size.
- No separate external power supply required (just KNX bus power).
- Can be used for single indoor units and group controlled (up to 16) indoor units.

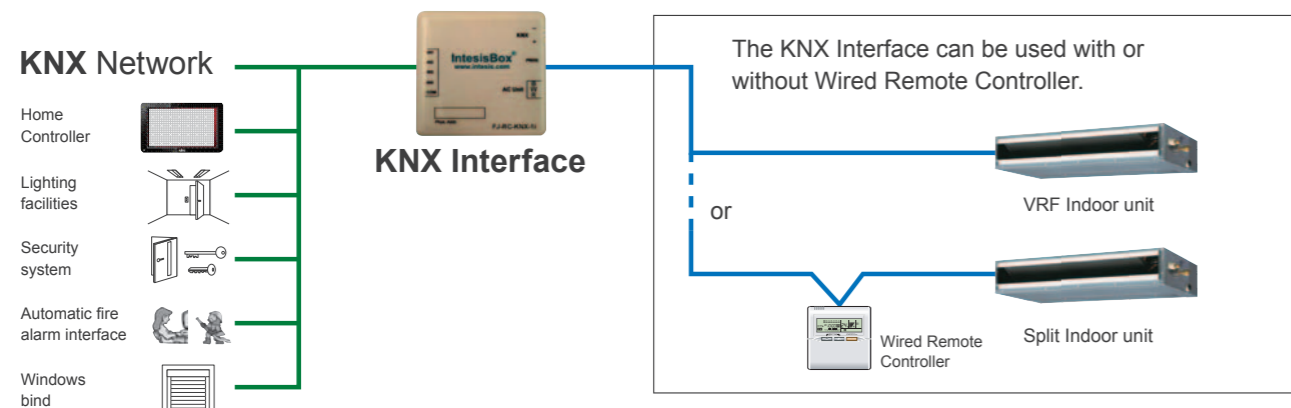

## MODBUS® Interface : FJ-RC-MBS-1

The MODBUS Interface allows a complete integration of air conditioners into MODBUS Networks.

- Simple installation due to small and compact size.
- No separate external power supply required.
- The MODBUS Interface permits central monitoring and control of air conditioners from BMS.

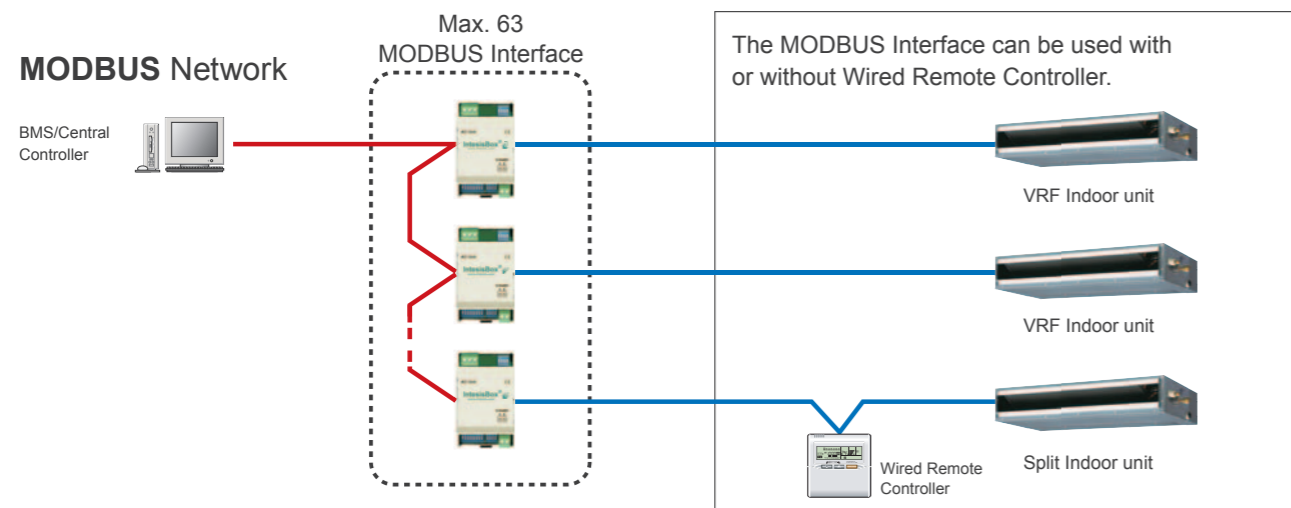

### Specifications

Model name	FJ-RC-MBS-1
Dimensions (H x W x D) (mm)	93×53×58
Weight (g)	85

Model name	FJ-RC-KNX-1i
Dimensions (H x W x D) (mm)	70×70×28
Weight (g)	70

## NEW Wireless LAN Interface : FJ-RC-WIFI-1

IntesisHome

- It is the most advanced solution to remotely manage an Air Conditioning system using all sort of mobile devices such as Smartphones, Tablets and PC
- No separate external power supply required
- Can be used for single indoor units and group controlled (up to 16) indoor units

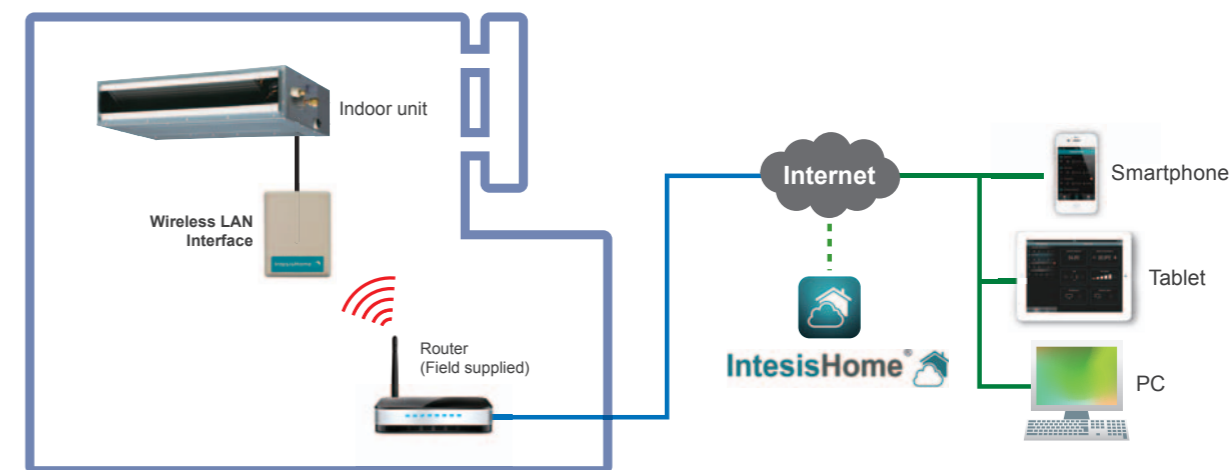
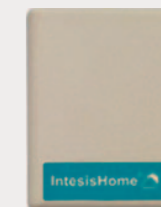

### Basic control

- Turning the units on and off
- Mode control (Heat, Cool, Dry, Auto, Fan)
- Fan speed setting
- Louver position (Airflow direction setting)
- Room temperature display
- Set temperature control
- Multi Language
- One Scene and Timer

### Advanced control (Optional functions)

- Climate working modes (ECO, Comfort, Powerful) (future release)
- Schedulable functionalities (ON/OFF, Modes, Set point temperature, Fan Speed, Louver position)
- Set temperature limitation (future release)
- Multiple Scenes & Timers and Calendar function

### Notifications and history

- Alerts e-mail notification (future release)
- Air conditioning malfunction alerts
- Connectivity monitoring and alerts
- History (future release)

### Specifications

Model name	FJ-RC-WIFI-1
Dimensions (H x W x D) (mm)	70×108×28
Weight (g)	80

## External Switch Controller : UTY-TEKX

Air conditioner switching can be controlled by connecting other sensor switches

- In combination with a field supply Card-Key Switch or other sensor, the External Switch Controller allows control of the ON / OFF, Room temperature, Fan speed and Master control functions. This makes this product suitable for installations such as hotel rooms.
- Card-key or other sensor switches are available as a field supplied parts.

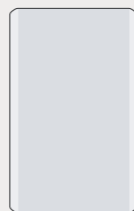

### Installation example

Auto mode operation, which switches the cooling and the heating automatically, is enabled by using the sensor switch and External Switch Controller.

Note: All indoor units will operate in the same mode.

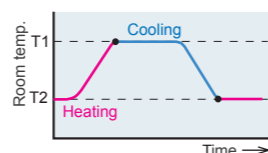
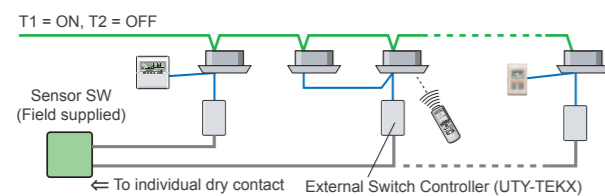

- Note 1. Please choose a thermosensor switch which can be set up for T1 and T2.
- Note 2. The remote controller's operation is prior to the auto mode operation.

### Electrical wiring

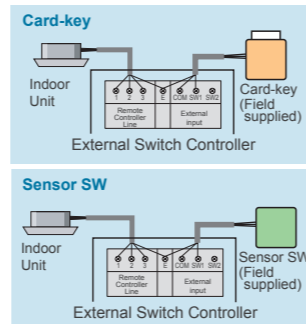

## Signal Amplifier : UTY-VSGXZ1

- Transmission Line length can be extended up to 3,600m with multiple Signal Amplifiers.
- Up to 8 signal amplifiers can be installed in a VRF network system.
- A signal amplifier is required,
  - (1) When the total wiring length of the transmission line exceeds 500m.
  - (2) When the total number of units on the transmission line exceeds 64.

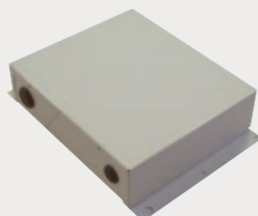

### Installation example

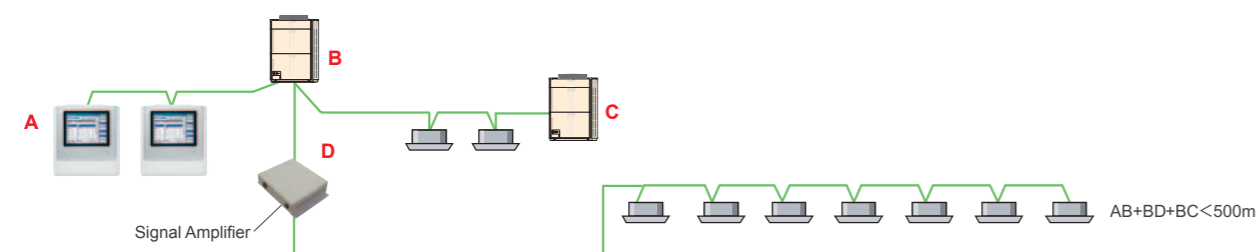

#### Specifications

Model name	UTY-TEKX
Power Supply	DC 12V
Dimensions (H x W x D) (mm)	120 x 75 x 30
Weight (g)	100

DC12V is supplied by the indoor unit.

Model name	UTY-VSGXZ1
Power Supply	208-240V 50/60Hz, Single phase
Power Consumption (W)	4.5
Dimensions (H x W x D) (mm)	67 x 288 x 211
Weight (g)	1,500

## Network Converter : UTY-VGGXZ1

Max. controllable  
**16**  
Network Converter units

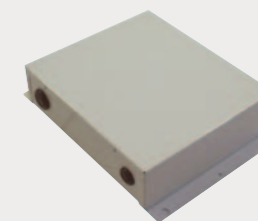

- This network converter is to be used for connecting single split system or group remote controller with the VRF network system.
- Please select the function by switching the dip switch during the installation.

### Installation example

- Split type systems can be controlled from a central remote controller or PC controller through connection to the VRF's network converter.
- Standard remote controller and central remote controller provide On / Off control, master control, temperature and fan control, etc.
- A single network converter can be used to connect and control up to 16 single units.

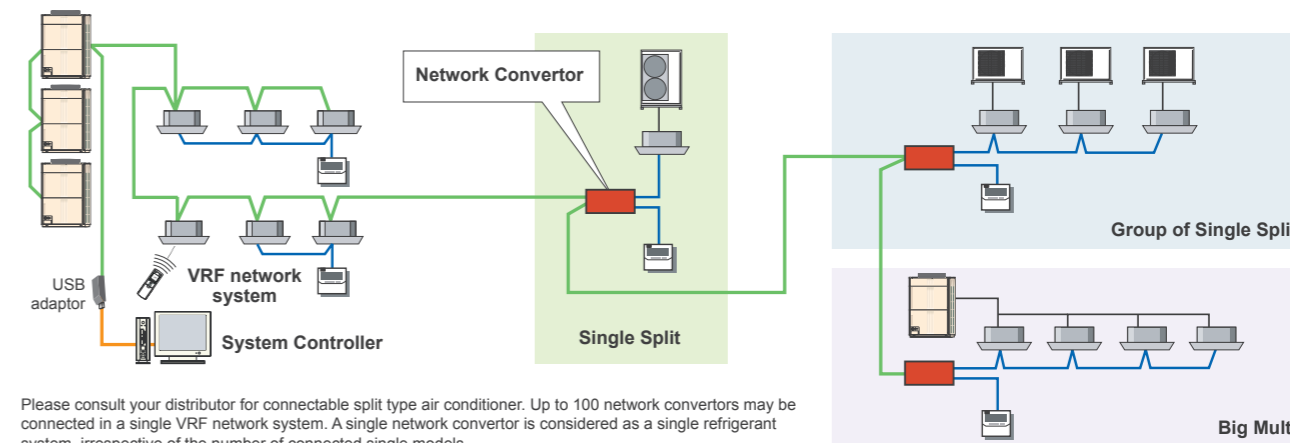

Please consult your distributor for connectable split type air conditioner. Up to 100 network converters may be connected in a single VRF network system. A single network converter is considered as a single refrigerant system, irrespective of the number of connected single models.

### Used for connecting Group Remote Controller

4 group remote controllers can be connected to a single Network converter.

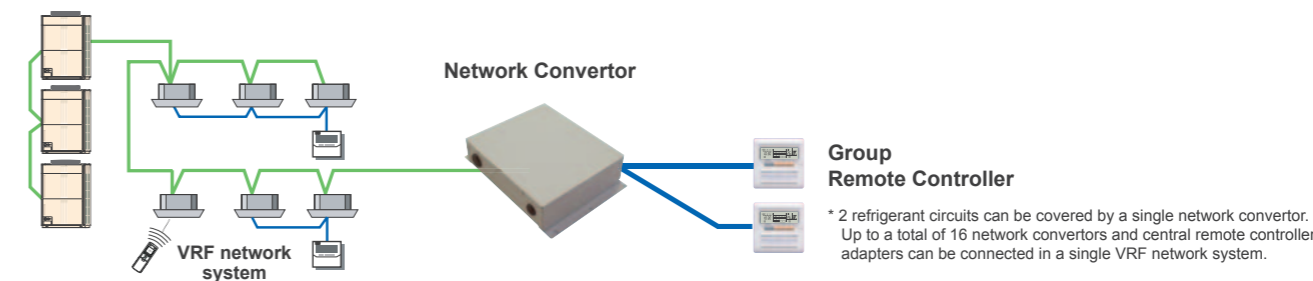

\* 2 refrigerant circuits can be covered by a single network converter. Up to a total of 16 network converters and central remote controller adapters can be connected in a single VRF network system.

#### Specifications

Model name	UTY-VGGXZ1
Power Supply	208-240V 50/60Hz, Single phase
Power Consumption (W)	6.5
Dimensions (H x W x D) (mm)	67 x 288 x 211
Weight (g)	1,500



## Service Tool : UTY-ASGX Software

Extensive monitoring and analysis functions for installation and maintenance

- Operation status can be checked and analyzed to detect even the smallest abnormalities
- Storage of data on system operation status on a PC allows access even from off site.
- Up to 400 indoor units (a single VRF network system) can be controlled and monitored for large scale buildings or hotels
- This software can be connected to any point of transmission line with USB adaptor (field supplied).



Max. Monitor and control  
**400**  
indoor units

Max. Monitor and control  
**100**  
outdoor units

## Web Monitoring Tool : UTY-AMGX Software

Product features

- Troubleshooting is performed by monitoring each air conditioning unit remotely during periodical system checks.
- Error notification can be automatically transmitted to several locations using the internet\*1.
- Requires either a dedicated internet connection or public telephone line.
- Determination of an error occurrence can be made through error warnings and equipment status information obtained from a remote location.
- The monitoring data in a remote side can be optionally downloaded. And, this data can be displayed in offline mode of the service tool.
- Monitoring side computer is not required to install special software, requires only general web browser.

\*1: Use of internet mail system required.

VRF network system can be supported  
**4**

**1,600**  
indoor units can be supported

## Wiring connection

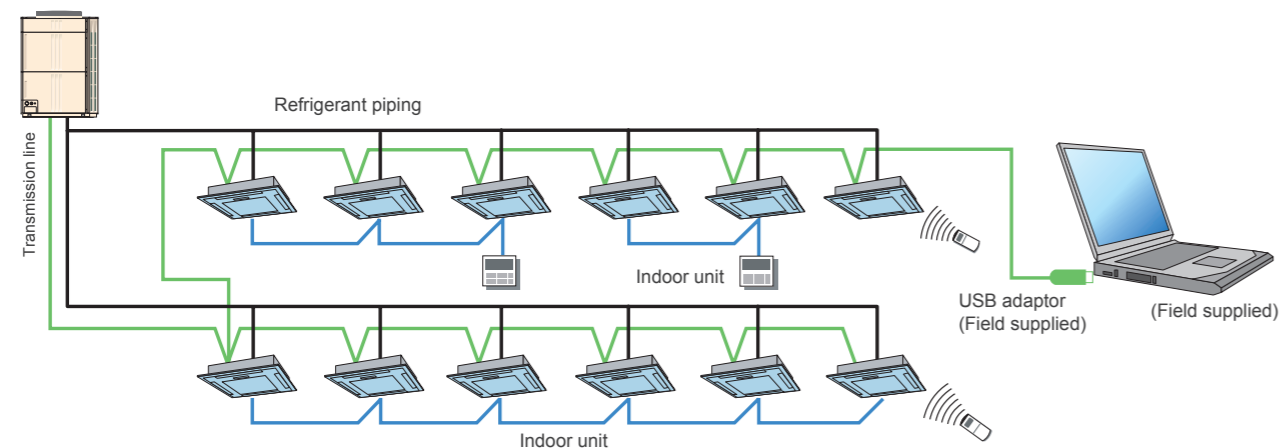

## Functions

• Equipment Detail (Diagram)

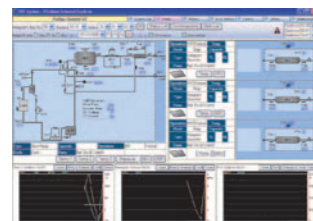

- Equipment Detail (List)
- Error History
- Remote File Download
- System List
- Commissioning Tool

## Web Monitoring System

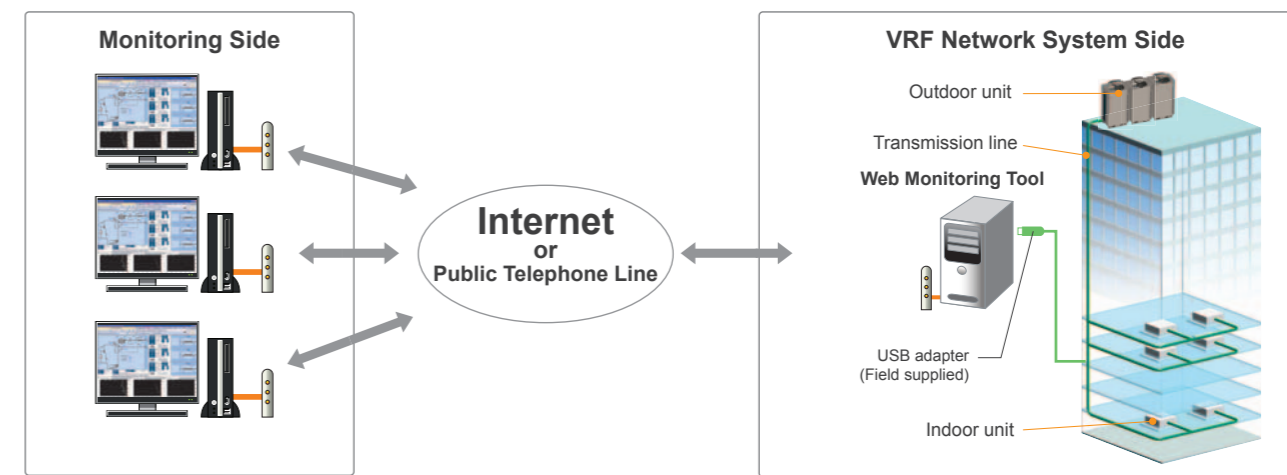

## Support 4 VRF network systems

USB adaptor (max. 4 adaptors per PC) permit monitoring of up to 1,600 indoor units. Suitable for large-scale buildings or hotels.

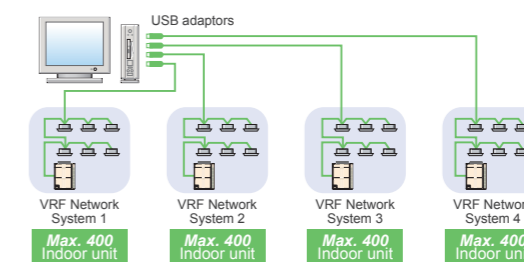

### Personal computer system requirements

	UTY-ASGX
Operating system	<ul style="list-style-type: none"> <li>• Microsoft® Windows Vista® Home Premium (32-bit) SP2, Windows Vista® Business (32-bit) SP2</li> <li>• Microsoft® Windows® 7 Professional (32-bit or 64-bit) SP1</li> <li>• Microsoft® Windows® 8 Pro (32-bit or 64-bit)</li> </ul>
CPU	1 GHz or higher
Memory	<ul style="list-style-type: none"> <li>• For Windows Vista®, Windows® 7 (32-bit), and Windows® 8 (32-bit): 1 GB or more</li> <li>• For Windows® 7 (64-bit) and Windows® 8.1 (64-bit): 2 GB or more</li> </ul>
HDD	10 GB or more of free space
Display	1024 x 768 or higher resolution
Interface	<ul style="list-style-type: none"> <li>• 2 USB ports</li> <li>- 1 USB port is required for WibuKey connection</li> <li>- 1 USB port is required for Echelon® U10 USB Network Interface</li> </ul>
Software	Internet Explorer® 8.0 or 9.0 or 10.0 / Adobe® Reader® 9.0 or later
Optical drive	DVD-ROM drive

### <Packing list>

Name and shape	Quantity	Application
DVD-ROM	1	Includes the software and manuals
WibuKey (Software protection key)	1	Software protection key to be connected to USB port on the Service Tool-installed PC. These products runs only on a PC with WibuKey.

Personal computer must be field supplied.

U10 USB Network Interface must be field supplied. Contact Echelon® Corporation or its local sales representative for detail.

Product Name : U10 USB Network Interface - TP/FT-10 Channel Model Number : 75010R

### Personal computer system requirements

	UTY-AMGX
Operating system	<ul style="list-style-type: none"> <li>• Microsoft® Windows Vista® Home Premium (32-bit) SP2, Windows Vista® Business (32-bit) SP2</li> <li>• Microsoft® Windows® 7 Professional (32-bit or 64-bit) SP1</li> <li>• Microsoft® Windows® 8 Pro (32-bit or 64-bit)</li> </ul>
CPU	1 GHz or higher
Memory	<ul style="list-style-type: none"> <li>• For Windows Vista®, Windows® 7 (32-bit), and Windows® 8 (32-bit): 1 GB or more</li> <li>• For Windows® 7 (64-bit) and Windows® 8 (64-bit): 2 GB or more</li> </ul>
HDD	40 GB or more of free space
Display	1024 x 768 or higher resolution
Interface	<ul style="list-style-type: none"> <li>• Ethernet port (for getting access to the Internet using LAN) or Modem (for getting access to the Internet using Public Telephone Line)</li> <li>• USB ports (Maximum of 5 ports)</li> <li>- 1 USB port is required for WibuKey connection</li> <li>- Maximum of 4 USB ports are required for Echelon® U10 USB Network Interface</li> <li>* Required maximum USB port numbers depend on the applicable system configurations.</li> </ul>
Software	Internet Explorer® 8.0 or 9.0 or 10.0 / Adobe® Reader® 9.0 or later
Optical drive	DVD-ROM drive

### <Packing list>

Name and shape	Quantity	Application
DVD-ROM	1	Includes the software and manuals
Wibu Key (Software protection key)	1	Software protection key to be connected to USB port on the Service Tool-installed PC. These products runs only on a PC with WibuKey.

Personal computer must be field supplied.

U10 USB Network Interface must be field supplied. Contact Echelon® Corporation or its local sales representative for detail.

Product Name : U10 USB Network Interface - TP/FT-10 Channel Model Number : 75010R



## Effective heat exchange and simultaneous fresh air ventilation

High Efficiency and low noise levels are achieved by using a highly efficient heat exchange process. A comfortable air conditioned space is achieved by conveniently selecting whether to use heat exchange or normal ventilation setting, according to the requirements of the conditioned space.”



- 164** Energy Recovery Ventilator
- 166** Outdoor Air Unit
- 168** DX-Kit for air handling applications

# VENTILATION



# Energy Recovery Ventilator

UTZ-BD025B / UTZ-BD035B / UTZ-BD050B / UTZ-BD080B / UTZ-BD100B

Energy recovery ventilator unit offers maximum comfort and greater energy savings.



## Features

**Adopts a highly efficient counter-flow heat exchange element**

**Heat exchange ventilation and normal ventilation**

**Heat exchange ventilation**  
When a room is cooled or heated, the exhausted cooling / heating energy is recovered by heat-exchange ventilation.

**Normal ventilation**  
The operation is used during periods when the room space requires no cooling or heating effect, i.e. when there is minimal temperature difference between the indoor and outdoor environments.

## High Efficiency

### Energy efficiency and ecology

Energy consumption is dramatically reduced by using a counter-flow heat-exchange element. Air conditioning load is reduced by approximately 20%, resulting in significant energy savings. Recovers up to 77% of the heat in the outgoing air.

**20%**  
Energy saving

### Features of heat exchange element

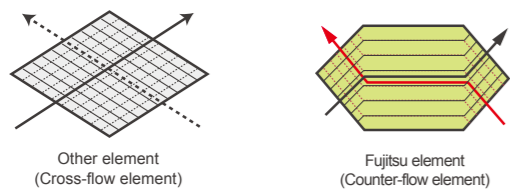

With the cross-flow element, air moves in a straight line across the element. With the counter-flow element, air flows through the element for a longer time (longer distance), so the heat-exchange effect remains unchanged.

## More Comfort

### Quiet operation

Significantly reducing low pressure loss and noise allows low-noise operation.

## Design Flexibility

### Extended range of an external static pressure

An external static pressure is improved by adopting a powerful fan motor. This allows for application in a wide variety building.

## Features

## Easy Installation and Maintenance

### Slim shape and easier installation

Counter-flow heat exchange element used for reduced noise and slimmer, more compact body shape.



### Reverse mountable direct air supply / exhaust system

Adoption of straight air supply / exhaust system: Duct design is simplified because the air supply / exhaust ducts are straight.

Since each unit can be mounted in reverse position, only one inspection hole is needed for two units: Two units can share one inspection hole so duct work is easier and more flexible.

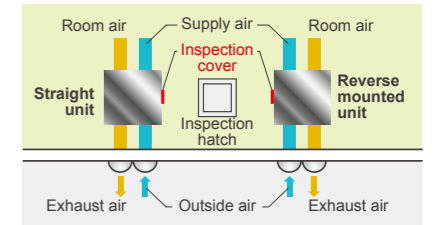

## Specifications

Rated flow rate		250 m <sup>3</sup> /h	350 m <sup>3</sup> /h	500 m <sup>3</sup> /h	800 m <sup>3</sup> /h	1000 m <sup>3</sup> /h	
Model No.		UTZ-BD025B	UTZ-BD035B	UTZ-BD050B	UTZ-BD080B	UTZ-BD100B	
Power source		220 - 240V, 50Hz					
Heat Exchange Ventilation	Input power	(Extra high)/High/Low W	128 / 123 / 96	190 / 185 / 168	289 / 225 / 185	418 / 378 / 295	464 / 432 / 311
	Air flow rate	(Extra high)/High/Low m <sup>3</sup> /h	250 / 250 / 190	350 / 350 / 240	500 / 500 / 440	800 / 800 / 630	1000 / 1000 / 700
	External static pressure	(Extra high)/High/Low Pa	105 / 95 / 45	140 / 60 / 45	120 / 60 / 35	140 / 110 / 55	105 / 80 / 75
	Temperature Exchange Efficiency	(Extra high)/High/Low %	75 / 75 / 77	75 / 75 / 78	75 / 75 / 76	75 / 75 / 76	75 / 75 / 79
	Energy Exchange Efficiency Cooling	(Extra high)/High/Low %	63 / 63 / 65	66 / 66 / 71	62 / 62 / 64	65 / 65 / 68	65 / 65 / 70
Normal Ventilation	Energy Exchange Efficiency Heat pump	(Extra high)/High/Low %	70 / 70 / 72	69 / 69 / 73	67 / 67 / 69	71 / 71 / 74	71 / 71 / 76
	Sound pressure level	(Extra high)/High/Low dB*	31.5 / 30.5 / 26.5	33 / 31 / 25.5	37.5 / 35.5 / 32.5	37.5 / 37 / 34.5	38.5 / 37.5 / 34.5
	Input power	(Extra high)/High/Low W	128 / 123 / 96	190 / 185 / 168	289 / 225 / 185	418 / 378 / 295	464 / 432 / 311
	Air flow rate	(Extra high)/High/Low m <sup>3</sup> /h	250 / 250 / 190	350 / 350 / 240	500 / 500 / 440	800 / 800 / 630	1000 / 1000 / 700
	External static pressure	(Extra high)/High/Low Pa	105 / 95 / 45	140 / 60 / 45	120 / 60 / 35	140 / 110 / 55	105 / 80 / 75
Sound pressure level	(Extra high)/High/Low dB*	31.5 / 30.5 / 26.5	33 / 31 / 25.5	38.5 / 38 / 32.5	37.5 / 37 / 34.5	40.5 / 39.5 / 36.5	
Dimensions	W×D×H	mm	882 x 599 x 270	1050 x 804 x 317	1090 x 904 x 317	1322 x 884 x 388	1322 x 1134 x 388
Weight	kg	29	49	57	71	83	
Outlet duct diameter	mm	150	150	200	250	250	
Operation range	°C	-10 to 40	-10 to 40	-10 to 40	-10 to 40	-10 to 40	
Maximum humidity	%	85	85	85	85	85	

\* The noise level must be measured 1.5 m below the centre of the unit.

## Dimensions Models : UTZ-BD025B / UTZ-BD035B / UTZ-BD050B / UTZ-BD080B / UTZ-BD100B

(Unit : mm)

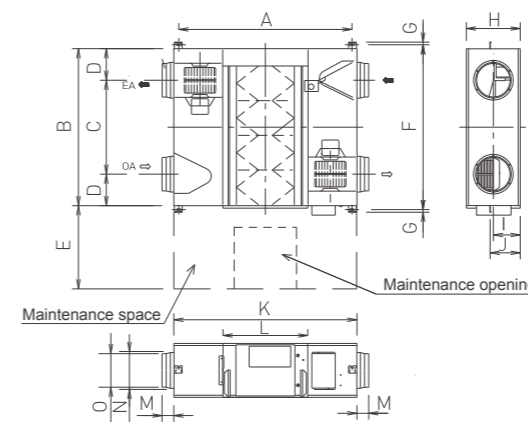

	UTZ-BD025B	UTZ-BD035B	UTZ-BD050B	UTZ-BD080B	UTZ-BD100B
A	810	978	1018	1250	1250
B	599	804	904	884	1134
C	315	580	640	428	678
D	142	112	132	228	228
E	600	600	600	600	600
F	655	860	960	940	1190
G	19	19	19	19	19
H	270	317	317	388	388
I	135	159	159	194	194
J	159	182	182	218	218
K	882	1050	1090	1322	1322
L	414	470	470	612	612
M	95	70	127	85	85
N	219	162	210	258	258
O	144	144	194	242	242

**NEW** ARXH054GTAH / ARXH072GTAH / ARXH096GTAH Production by order

The heat pump method efficiently processes the outdoor air for cooling and heating and supplies 100% fresh air into a room.



## Features

### One VRF system can provide air conditioning and air supply at the same time.

Outdoor Air Unit can be connected in a same VRF<sup>\*1</sup> system as one of indoor unit series and can create fresh and comfortable air supply together from our high advanced technology.

\*1. Connectable VRF series: J-IIS, J-II, V-II, VR-II  
In J-II series alone, OAU is prohibit to connect under the ambient temperature of 40°C or higher.

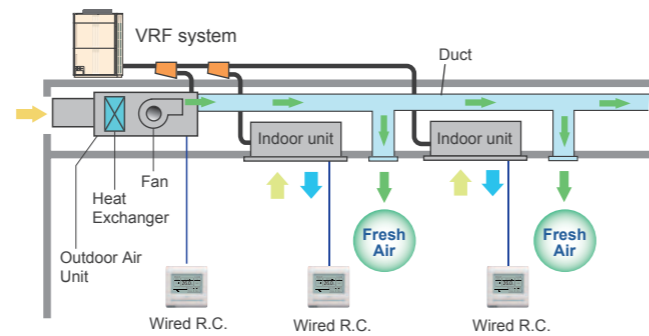
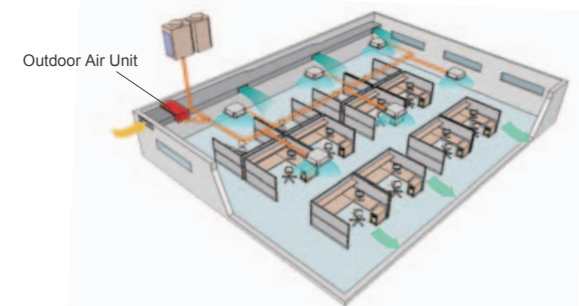

\* Make sure the connected capacity is within the range of 50% to 100% of the outdoor unit capacity. In addition, if there are mixed connections with indoor units, make the Outdoor Air Unit connection capacity 30% or less of the outdoor unit capacity.

### High energy savings and flexible duct design by using DC motor

- Greatly reduces electricity consumption by adopting permanent magnet compared to when using an AC motor.

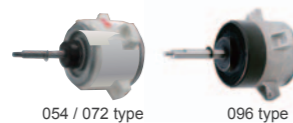

- Compared with AC motor, changing the speed makes it possible to respond flexibly to the external static pressure from 50 Pa to 240 Pa. Even if damper equipment is not used, static pressure can be adjusted and duct design is easy.

- Static pressure can be set easily using wired remote controller.

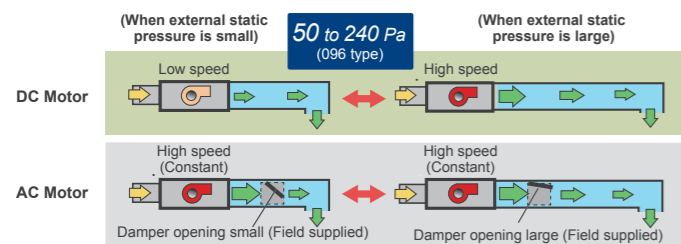

### Top class compact design

- Top class lightweight compact design at just 425 mm in height, 55 kg in weight for ARXH072 type. This unit can be installed easily even at narrow space.

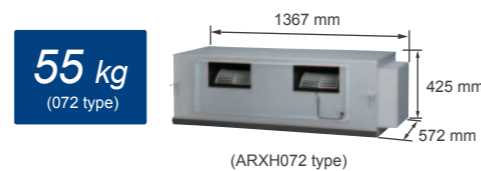

## Features

### Various Controller

Supplied variety of controllers as options, such as individual controller, central controller, and building management controller.

#### Individual Controller

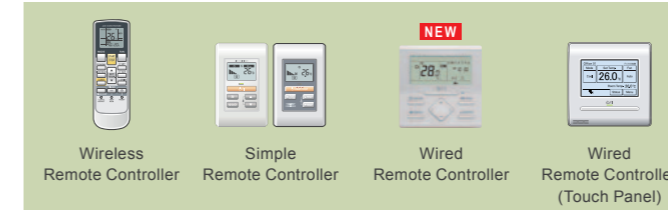

#### Central Controller



\* The temperature setting is discharged air temperature setting. The air volume is set to a constant speed.

## Specifications

(Tentative)

Model name		ARXH054GTAH	ARXH072GTAH	ARXH096GTAH
Power Source	V/Ø/Hz	230/1/50	230/1/50	230/1/50
Capacity	Cooling	14.0	22.4	28.0
	Heating	8.9	13.9	17.4
Input Power	Cooling/Heating W	179	292	370
Airflow Rate	m <sup>3</sup> /h	1,080	1,680	2,100
Static Pressure	Standard (range) Pa	185 (50-185)	200 (50-200)	200 (50-240)
Sound Pressure Level	dB (A)	42	44	47
Dimensions (H x W x D)	mm	425×1,367×572	425×1,367×572	450×1,583×700
Weight	kg	48	55	71
Connection Pipe Diameter (Small / Large)	mm	Ø9.52/Ø19.05	Ø12.70/Ø22.22	Ø12.70/Ø22.22
Operation Range	Cooling	5 to 43	5 to 43	5 to 43
	Heating	-7 to 21	-7 to 21	-7 to 21
Refrigerant		R410A	R410A	R410A

Note : Specifications are based on the following conditions. Cooling : Outdoor temperature of 33°CDB / 28°CWB. Heating : Outdoor temperature of 0°CDB / -2.9°CWB. Pipe length : 7.5 m Voltage : 230 [V].

## Dimensions Models : ARXH054GTAH/ARXH072GTAH/ARXH096GTAH

(Unit : mm)

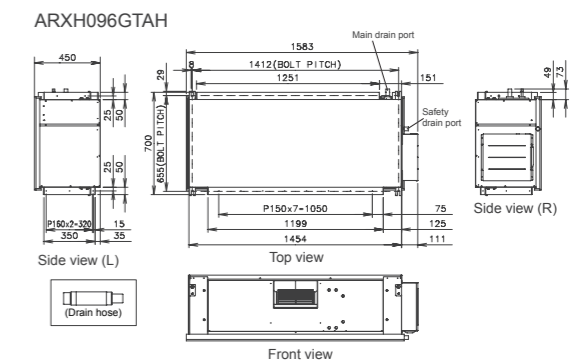
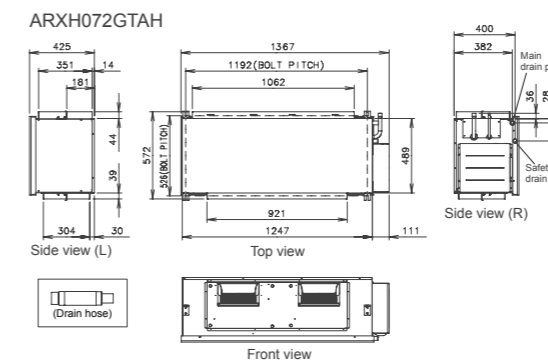
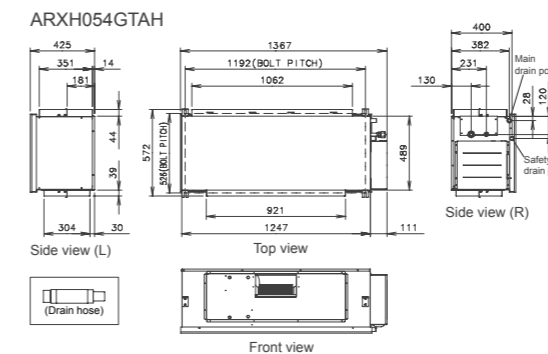

**NEW** Control unit : UTY-VDGX

**NEW** EEV unit : UTP-VX30A / UTP-VX60A / UTP-VX90A

Future Release

This kit can connect the general-purpose air handling unit (AHU) and the fan coil unit (FCU) to the VRF system. It enables VRF system to control the operation of both air conditioner and ventilation.

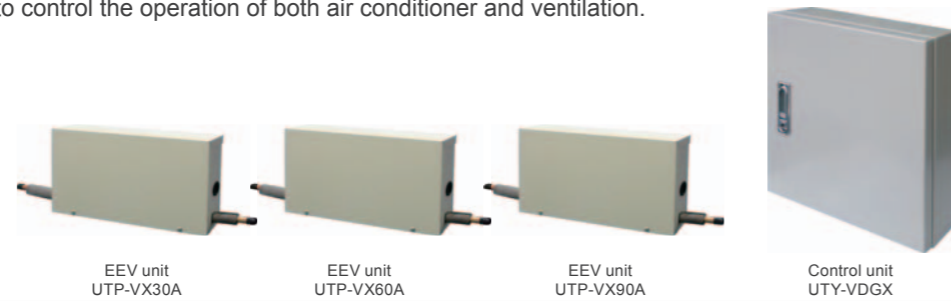

**Features**

**Multiple temperature sensors optimally control the air handling unit and fan coil unit.**

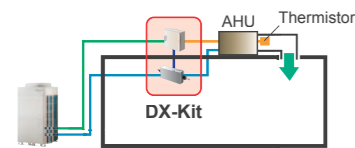

In case of connecting the air handling unit, the supply air temperature is controlled optimally by the discharge temperature control.

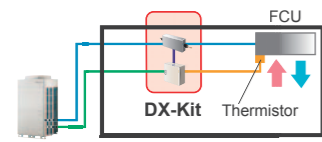

In case of connecting the fan coil unit, the room temperature is controlled optimally by the intake temperature control.

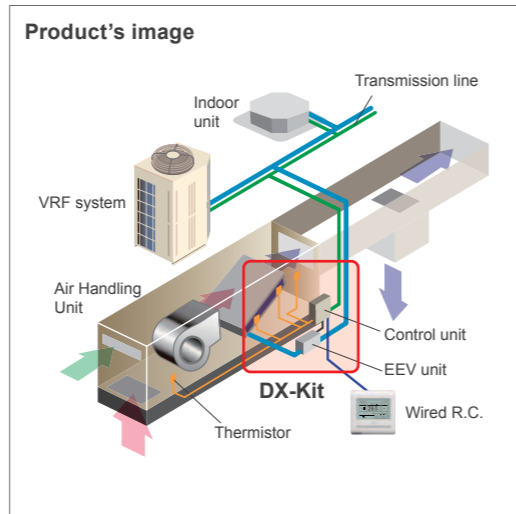

**Supports a wide range of capacity classes**

- 2 EEV units can be connected in parallel and up to 20 HP (50 kW) large capacity units can be connected.
- Connectable capacity range: 5 kW to 50 kW

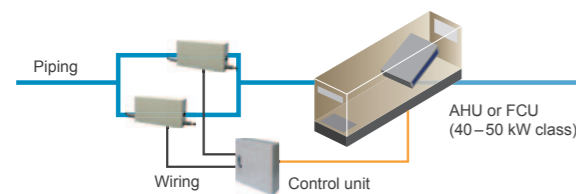

**A variety of controls to match the application**

- Central control using our VRF controllers or central management controllers

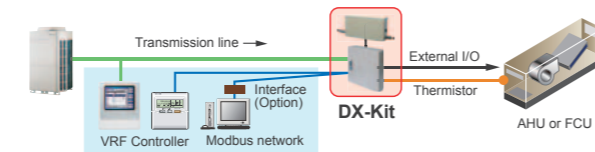

- Central control from external controllers

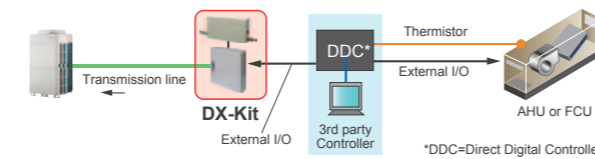

**Features**

**Functions Summary**

**Inputs**

- ON/OFF
- Setting temperature
- Capacity demand
- Heating / Cooling operation mode
- Fault information

**Outputs**

- ON/OFF indication
- Fan ON/OFF indication
- Thermo ON/OFF indication
- Defrost indication
- Fault indication

**Installation Limitation**

- Connectable VRF series : J-IIS, J-II, V-II, VR-II
- Connectable DX-Kit system capacity range : 50 to 100% of the outdoor unit capacity
- Connectable DX-Kit system capacity range with indoor units : 30% or less of the outdoor unit capacity
- Max. wiring length from control unit : 15 m
- Max. piping length between EEV unit and indoor unit : 5 m
- Outdoor installation : Control unit (IP54 class) and EEV unit can be installed at an outdoor space.

**Connectable capacity**

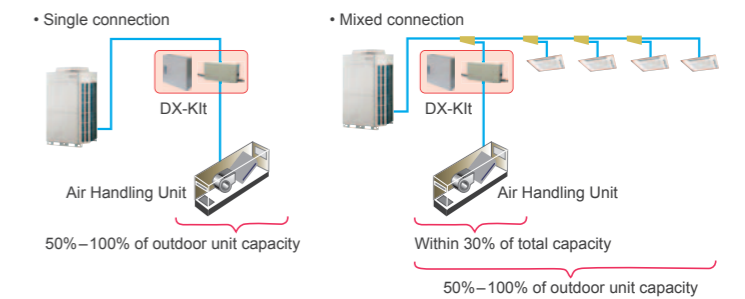

**Piping and wiring length**

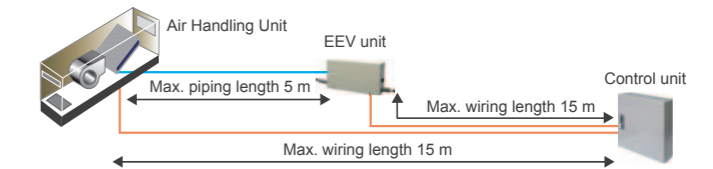

**Specifications**

Connectable Capacity class		5.0kW	6.3kW	8.0kW	10.0kW	12.5kW	14.0kW	20.0kW	25.0kW	40.0kW	50.0kW
Capacity	Cooling	5.6	6.3	8.0	10.0	12.5	14.0	22.4	25.0	40.0	50.4
	Heating	6.3	7.1	9.0	11.2	14.0	16.0	25.0	28.0	45.0	56.5
<b>Control unit</b>		<b>UTY-VDGX</b>									
Power source	V/∅/Hz	230 / 1 / 50									
Dimensions (H × W × D)	mm	-									
<b>EEV unit</b>		<b>UTP-VX30A</b>	<b>UTP-VX60A</b>	<b>UTP-VX90A</b>	<b>UTP-VX90A×2</b>						
Connection pipe diameter (Liquid)	mm	∅9.53	∅12.7	∅12.7	∅12.7						
Dimensions (H × W × D)	mm	-									

\*Data were not available at time of production.  
 Note : Specifications are based on the following conditions.  
 Cooling : Indoor temperature of 27°CDB / 19°CWB, and outdoor temperature of 35°CDB / 24°CWB.  
 Heating : Indoor temperature of 20°CDB / (15°CWB), and outdoor temperature of 7°CDB / 6°CWB.  
 Pipe length : 7.5 m Voltage : 230 [V].

## Connection Units

### Separation Tube

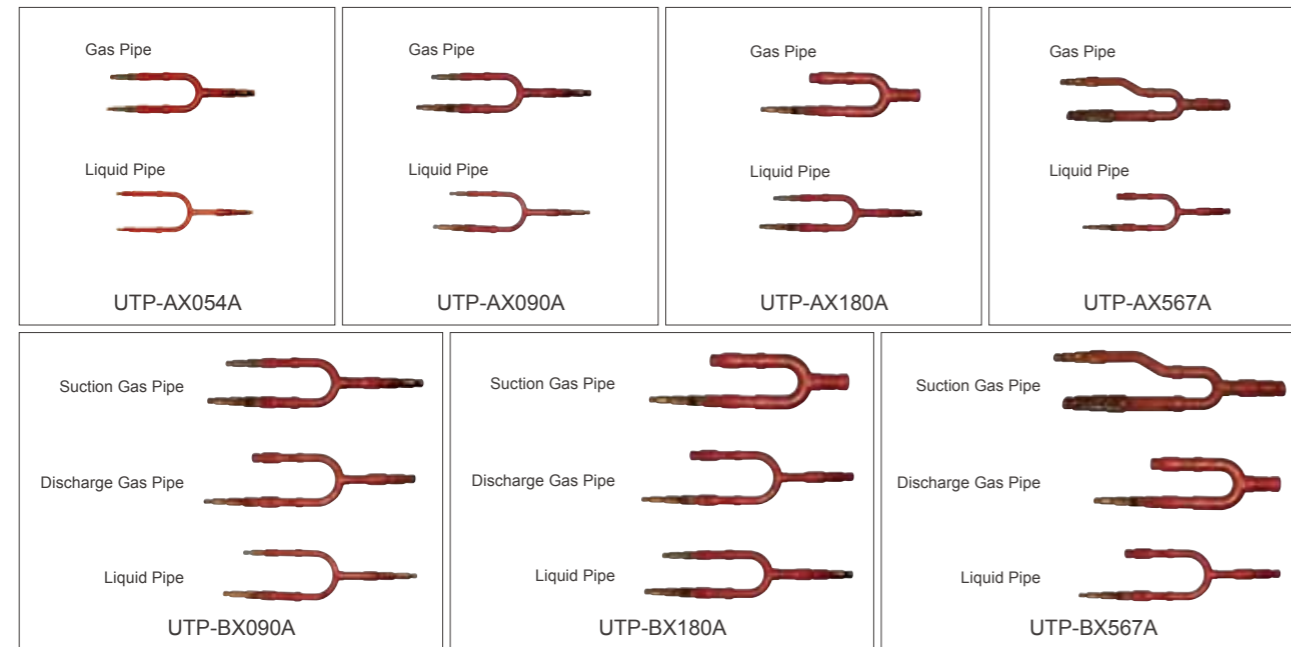

### Header

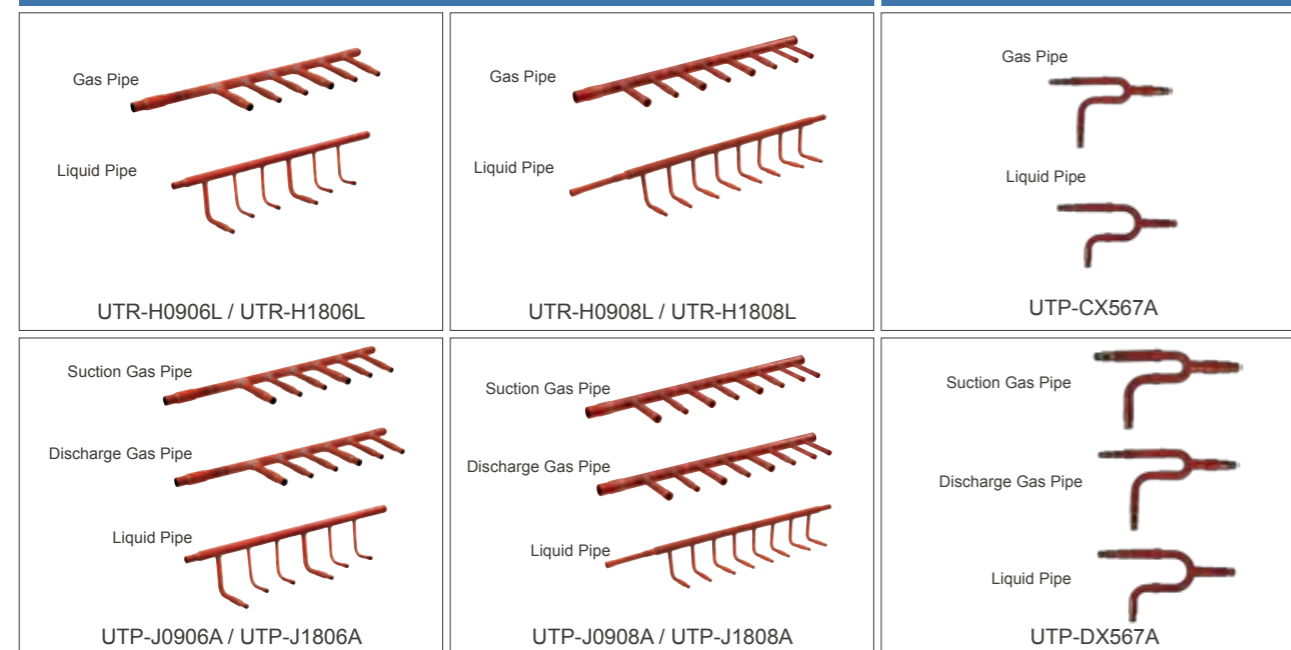

### EV Kit



## Specifications

### Separation Tube

Model name	UTP-AX054A (for J-IIS only)	UTP-AX090A	UTP-AX180A	UTP-AX567A
Total cooling capacity of indoor unit (kW)	19.6 or less	28.0 or less	28.1 to 56.0	56.1 or more

Model name	UTP-BX090A	UTP-BX180A	UTP-BX567A
Total cooling capacity of indoor unit (kW)	28.0 or less	28.1 to 56.0	56.1 or more

### Header

Model name	3-6 Branches	UTR-H0906L	UTR-H1806L
	3-8 Branches	UTR-H0908L	UTR-H1808L
Total cooling capacity of indoor unit (kW)	28.0 or less		28.1 to 56.0

Model name	3-6 Branches	UTP-J0906A	UTP-J1806A
	3-8 Branches	UTP-J0908A	UTP-J1808A
Total cooling capacity of indoor unit (kW)	28.0 or less		28.1 to 56.0

### Outdoor unit Branch kit

Model name	UTP-CX567A (for V-II)		UTP-DX567A (for VR-II)	
Number of outdoor unit	2 outdoor units	1		
	3 outdoor units	2		

### EV Kit

Model name	UTR-EV09XB	UTR-EV14XB
Application model	ASYE04GACH ASYE07GACH ASYE09GACH	ASYE12GACH ASYE14GACH







### RB Unit

Type	Single type			Multi type
Model name	UTP-RX01AH	UTP-RX01BH	UTP-RX01CH	UTP-RX04BH
Power source	V/∅/Hz 230 / 1/50			
Input power	W 17	24	31	96
Number of branches	1	1	1	4
Maximum capacity of connectable indoor units (Q)	kW Q ≥ 8.0	Q ≤ 18.0	Q ≤ 28.0	Q ≤ 56.0 *1
Maximum capacity of connectable indoor units per branch (Q)	kW Q ≥ 8.0	Q ≤ 18.0	Q ≤ 28.0	Q ≤ 18.0
Maximum number of connectable indoor units per branch	3	8	8	8
Dimensions (H×W×D)	mm 198×298×268			260×658×428





\*1: In case of two RB units connected in series ( total 8-branches ), maximum capacity of connectable indoor units is up to 56.0 kW.

## Controllers

### For Individual Control





<p><b>Wired Remote Controller (Touch Panel)</b> UTY-RNRY</p> 	<p><b>Wired Remote Controller</b> <b>NEW</b> UTY-RLRY</p> 	<p><b>Simple Remote Controller</b> UTY-RSKY With operation mode</p> 
<p><b>Simple Remote Controller</b> UTY-RHKY Without operation mode</p> 	<p><b>Wireless Remote Controller</b> UTY-LNHY</p> 	<p><b>IR Receiver Unit</b> UTB-YWC For All Duct type</p> 
<p><b>IR Receiver Unit</b> UTY-LRHYB1 For Cassette type</p> 		

### For Centralized Control

<p><b>Group Remote Controller</b> UTY-CGGY</p> 	<p><b>Central Remote Controller</b> UTY-DCGY</p> 	<p><b>Touch Panel Controller</b> UTY-DTGY</p> 		
<p><b>System Controller Lite</b> <span>Software</span> <b>NEW</b> UTY-ALGX</p> 			<p><b>System Controller</b> <span>Software</span> UTY-APGX</p> 	

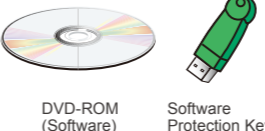
## Convertors / Adaptors

### For External device

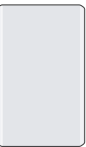
<p><b>BACnet® Gateway</b> <span>Software</span> UTY-ABGX</p> 	<p><b>Network Converter for LonWorks®</b> UTY-VLGX</p> 	<p><b>KNX® Interface</b> FJ-RC-KNX-1i</p> 
<p><b>MODBUS® Interface</b> FJ-RC-MBS-1</p> 	<p><b>Wireless LAN Interface</b> <b>NEW</b> FJ-RC-WIFI-1</p> 	<p><b>External Switch Controller</b> UTY-TEKX</p> 

### For System expansion

<p><b>Network Converter</b> UTY-VGGXZ1</p> 	<p><b>Signal Amplifier</b> UTY-VSGXZ1</p> 
--	---

## Panels

### For Cassette type

<p><b>Cassette Grille</b> UTG-UFYC-W For Compact Cassette type</p> 	<p><b>Cassette Grille</b> UTG-UGYA-W For Cassette type</p> 
--	--

## Others

### Communication system : External Connect Kit

For Indoor unit		For Outdoor unit	
UTY-XWZXZ7		UTY-XWZXZD	
UTY-XWZXZB		UTY-XWZXZE	
UTY-XWZXZC			

For RB unit	For Central Remote Controller	For Touch Panel Controller
UTY-XWZXZ6	UTY-XWZXZ7	UTY-XWZXZA
UTY-XWZXZB	UTY-XWZXZ8	
	UTY-XWZXZA	

### Function list

	Indoor unit	Outdoor unit	Controller		Other
			Central Remote Controller	Touch Panel Controller	RB Unit
Input	Operation / Stop	● UTY-XWZXZD ○ UTY-XWZXZB	—	—	—
	All On / All Off	—	—	● UTY-XWZXZ7 ○ UTY-XWZXZ8	—
	Batch Stop	—	● UTY-XWZXZ6	—	—
	Forced Stop	● UTY-XWZXZD ○ UTY-XWZXZB	—	—	—
	Emergency Stop	● UTY-XWZXZD ○ UTY-XWZXZB	● UTY-XWZXZ6	● UTY-XWZXZ7 ○ UTY-XWZXZ8	—
	Forced Thermostat off	● UTY-XWZXZE ○ UTY-XWZXZ7	—	—	—
	Low Noise Mode Operation	—	● UTY-XWZXZ6	—	—
	Cooling / Heating Priority	—	● UTY-XWZXZ6*1	—	● UTY-XWZXZ6 ○ UTY-XWZXZB
	"Outdoor Unit Operation Peak Control"	—	● UTY-XWZXZ6	—	—
	"Power Usage Information from Electricity Meter"	—	● UTY-XWZXZ6	—	—
Output	Operation Status	● UTY-XWZXZC	○ UTY-XWZXZ6	○ UTY-XWZXZA	○ UTY-XWZXZA
	Error Status	● UTY-XWZXZC	○ UTY-XWZXZ6	○ UTY-XWZXZA	○ UTY-XWZXZA
	Indoor Unit Fun Operation Status	● UTY-XWZXZC	—	—	—
	Auxiliary Heater Output	● UTY-XWZXZC*2	—	—	—
	Base Heater	—	● UTY-XWZXZ9	—	—

\*1. Heat Pump type only \*2. Duct type only

● : Dry Contact ○ : Apply Voltage

### For Duct type

<b>Flange (Round)</b> UTD-RF204 For Medium Static Pressure Duct type / Ceiling type 	<b>Flange (Square)</b> UTD-SF045T For Medium Static Pressure Duct type 	<b>Remote Sensor Unit</b> UTY-XSZX For All Duct type New amenity space can be offered by installing the Remote sensor. 
<b>Long-Life Filter</b> UTD-LF25NA For Medium Static Pressure Duct type UTD-LF60KA For High Static Pressure Duct type 	<b>Auto Louver Grille Kit</b> UTD-GXSA-W (for ARXD04/07/09/12/14GALH) UTD-GXSB-W (for ARXD18GALH) UTD-GXSC-W (for ARXD24GALH) For Slim Duct type 	<b>Drain Pump Unit</b> UTZ-PX1BBA For Low Static Pressure Duct type UTZ-PX1NBA For Medium Static Pressure Duct type 

### For Cassette type

<b>Wide Panel</b> UTG-AGYA-W For Cassette type 	<b>Panel Spacer</b> UTG-BGYA-W For Cassette type 	<b>Insulation Kit for High Humidity</b> UTZ-KXGA For Cassette type UTZ-KXGB For Slim Cassette type UTZ-KXGC For Compact Cassette type 
<b>Fresh Air Intake Kit</b> UTZ-VXAA For Compact Cassette type UTZ-VXGA For Cassette type 	<b>Air Outlet Shutter Plate</b> UTR-YDZB For Compact Cassette type Shuts the air outlet when only using as 3 blow out. 	<b>Air Outlet Shutter Plate</b> UTR-YDZC For Cassette type Shuts the air outlet when only using as 3 blow out. 

### For Ceiling type

<b>Drain Pump Unit</b> UTR-DPB24T For Ceiling type 
--





### WHAT'S A HEAT PUMP ?

Absorbing free energy from the atmosphere. Heat pump system requires only 1 kW of electricity to generate 3 to 5 kW thermal energy.



## **WATERSTAGE™** makes an Economical and Clean hot water heating system by Heat Pump

### Complete Solution meets various needs

The clean energy produced by **WATERSTAGE™** reliably delivers "comfort" to all spaces in the home up to the living room, bedrooms, bath, and swimming pool.



## **WATERSTAGE**

- 178 Split type
- 179 Split DHW Integrated type
- 180 Monobloc type
- 181 Smart & Comfort Control
- 182 Case studies
- 184 Optional parts
- 186 Installation Limitations
- 187 Dimensions
- 188 Specifications

# AIR TO WATER



## High power series

Hydraulic unit : WSYG140DC6 / [3phase] WSYK160DC9  
 Outdoor unit : WOYG112LCT / WOYG140LCT  
 [3phase] WOYK112LCT / WOYK140LCT / WOYK160LCT



## Comfort series

Hydraulic unit : WSYA050DD6 / WSYA100DD6  
 Outdoor unit : WOYA060LDC / WOYA080LDC / WOYA100LDT



## High power series

Hydraulic unit : WGYG140DD6 / [3phase] WGYK160DD9  
 Outdoor unit : WOYG112LCT / WOYG140LCT  
 [3phase] WOYK112LCT / WOYK140LCT / WOYK160LCT



## Comfort series

Hydraulic unit : WGYA050DD6 / WGYA100DD6  
 Outdoor unit : WOYA060LDC / WOYA080LDC / WOYA100LDT

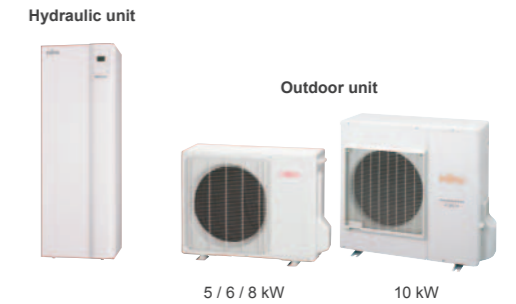

## Features

### High Efficiency & Comfort

#### High leaving water temperature

**High power series** : High leaving water temperature of 60°C is kept even when outdoor temperature is down to -20°C without using backup heaters.

At -20°C outdoor temperature : 60°C Hot water

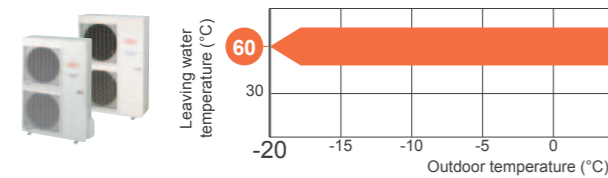

**Comfort series** : Maximum leaving water temperature is 55°C without backup heater. Hot water supply temperature can be maintained even at -7°C outdoor temperature.

At -7°C outdoor temperature : 55°C Hot water

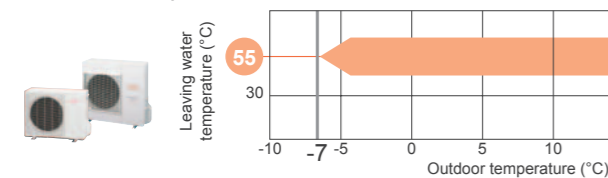

\* If you want to raise the hot water supply temperature, backup heaters can be used for auxiliary operation.

#### High COP

Air to water heat pumps work with much more efficiency and save more energy than a traditional heating system.



\*The data refer to 16kW type Condition : Outdoor Temp. 7°C Heating Temp. 35°C.

#### Wide operation range

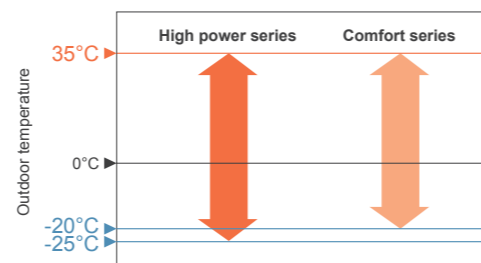

### Intelligent Control

#### 2 Zone individual control\*

2 Zone individual control (2 under floor heating zones or under floor heating + radiator zone, etc.)\*

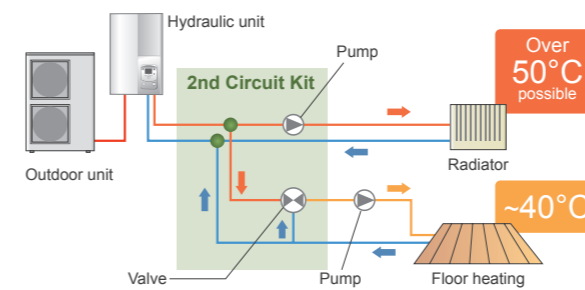

\*Optional parts are required.

#### Automatic heating curve control

Automatic temperature regulation in accordance with heating curve (Depends on heating terminal and outdoor temperature)

Automatic temperature control with heating curve

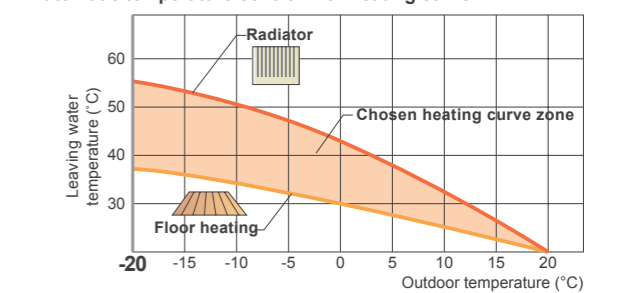

### High Reliability

#### High durability

- Corrosion protected
- No flow switch and no filter necessary

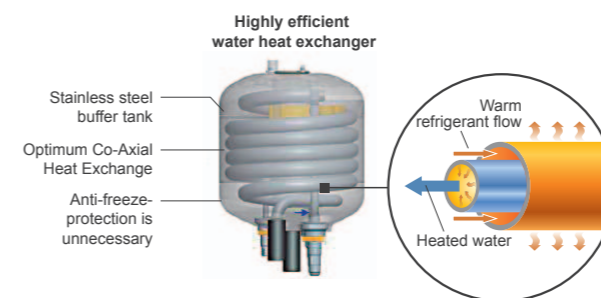

#### Emergency operation

System can continuously supply hot water by built in back up heater or boiler, as emergency, even if an error has occurred.

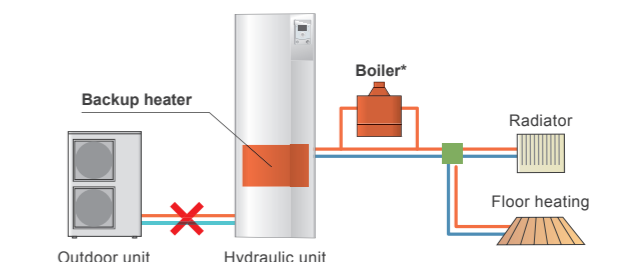

\*When additional boiler is connected



## Compact series

Monobloc unit : WPYA080LE / WPYA100LE

Control box : UTW-SCBYA



## Features

### Compact & High Performance

#### High leaving water temperature

High leaving water temperature of 55°C is kept even when outdoor temperature is down to -20°C without using backup heaters.

No backup heater

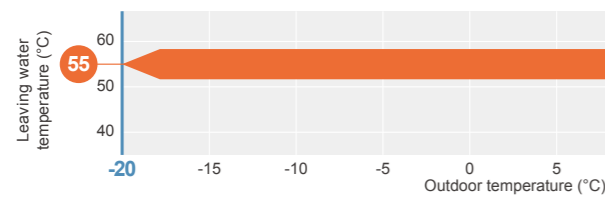

#### High COP

High COP is realized by using a DC twin rotary compressor, inverter technology, and high efficient water heat exchanger.

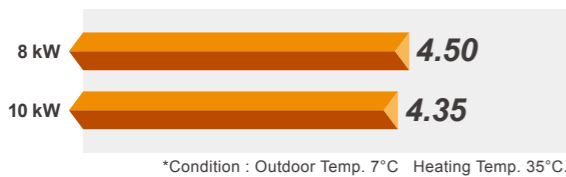

### Compact & light weight design



Weight 74kg

### Intelligent Control

#### Wired remote controller (control box) is adopted as standard.



#### And more

- Automatic heating curve control
- Cooling operation is possible
- Anti-Legionella function
- Possible to docking the boiler or electric heater for backup (Field supplied)

### High Reliability

#### Anti-freeze function

Water circulation and compression can be automatically performed at low outdoor temperature. Freezing of circulated water can be prevented.

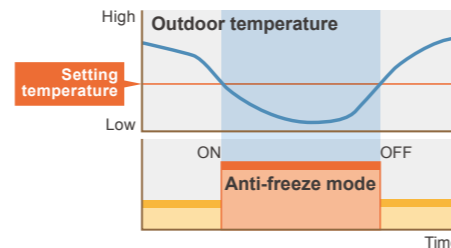

#### Easy installation & maintenance

- No installation of refrigerant circuit connections.
- Easy access for maintenance operations

## Comfort



**Large LCD display**  
 •Operation status display  
 •Error display  
 •Plain text

### Automatic heating curve operation

Automatic heating curve control based on outdoor temperature and setting room temperature.

This can be adjusted when too warm or too cold.

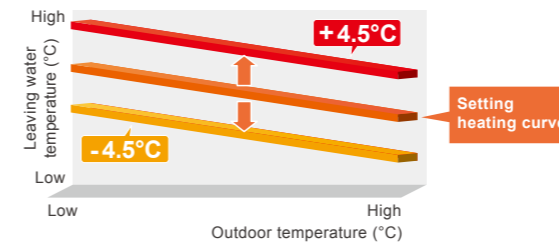

**Simple operation mode setting**  
 •Selecting the heating mode and Domestic hot water operation



**Navigation and setting**  
 •Selecting the heating menu  
 •Setting program timer

## Energy Saving

### Programmable timer

- The setting of timer operation can easily be adjusted.
- Changing the heating mode linked with time is possible.

Heating mode	
<b>Auto</b> Automatic mode Comfort/Reduce mode switching automatically according to outdoor temperature	<b>Comfort mode</b> Constant comfort temperature
<b>Reduce mode</b> Constant reduce temperature	<b>Protection mode</b> Stand-by mode with anti-frost protection

### Day-Weekly timer setting

- The day-weekly timer can be set up for up to 3 times per day.
- Allows separate settings for each day of the week.

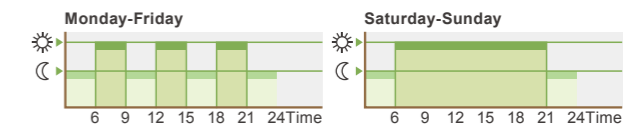

### Holiday timer setting

- The holiday timer can be set up for up to 8 periods
- If you are absent for a long time in the winter, freezing of room can be prevented.

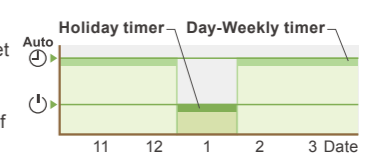

## Safety Function

### Auto-changeover

If the cooling operation function is set, the system can automatically switch to cooling or heating, depending on the outdoor temperature to provide all-season comfortable air conditioner.

## Extendibility

### Remote control-extension

Various remote controls are available on your hands. Remote control is also available via Web. All kinds of life styles are supported.

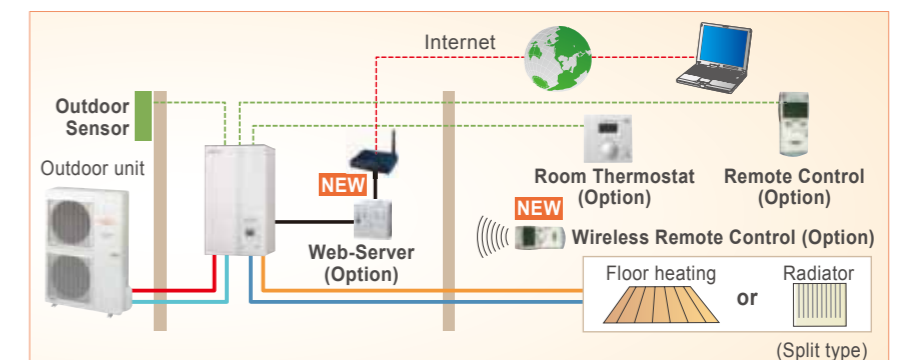

Split Case studies

2 emitter simultaneous heating (Individual control)

Floor heating + Radiator

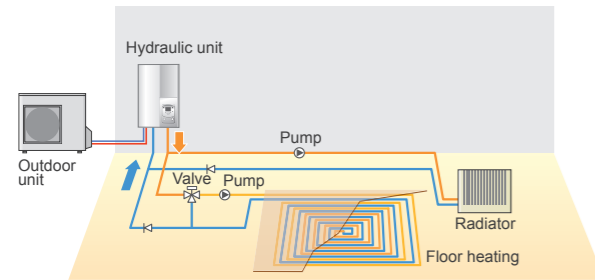

3 types of heat distribution

Floor heating + Radiator + Domestic Hot Water

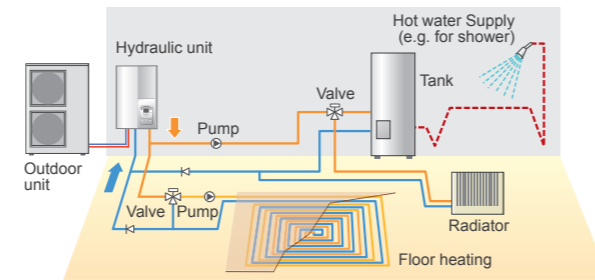

Boiler connected to heating (Boiler + Heating)

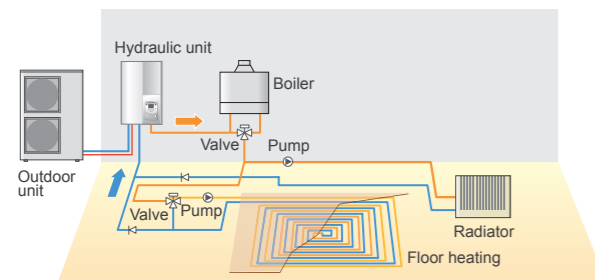

Split DHW integrated Case studies

Single heating & Domestic Hot Water

Radiator + Domestic Hot Water

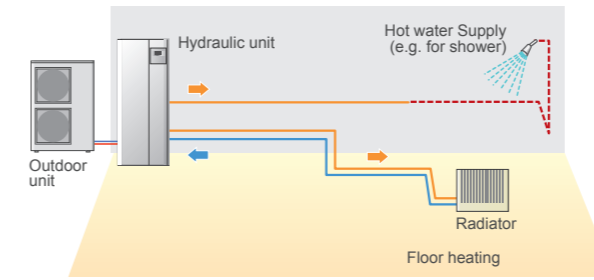

Boiler connected to heating (Boiler + Heating) & Domestic Hot Water

Radiator + Domestic Hot Water

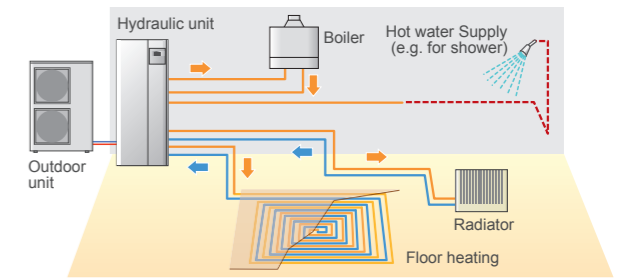

2 emitter simultaneous heating (Individual control) & Domestic Hot Water

Radiator + Domestic Hot Water

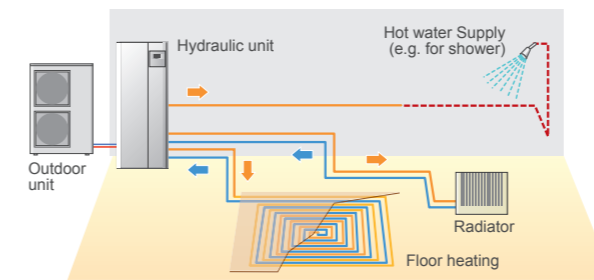

Split Cascade System Case studies

2 emitter simultaneous heating (Individual control)

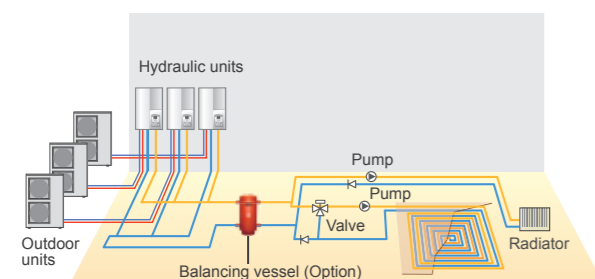

2 emitter simultaneous heating & Domestic Hot Water (type A)

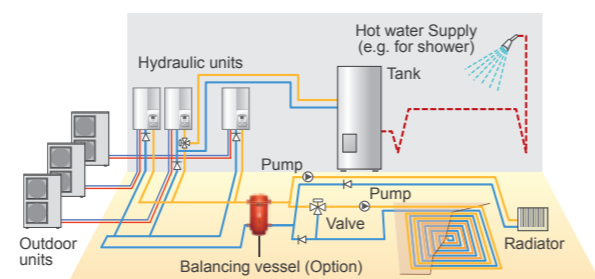

Boiler connected to heating (Boiler + Heating)

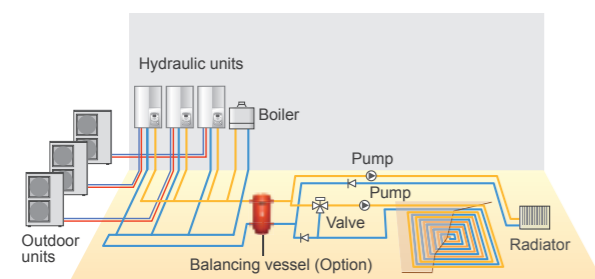

2 emitter simultaneous heating & Domestic Hot Water (type B)

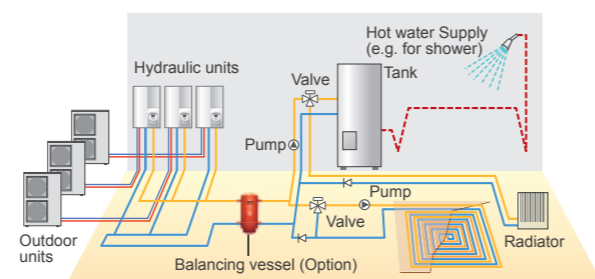

Monobloc Case studies

Single heating system

Floor heating

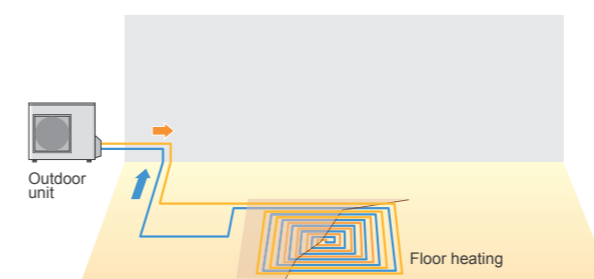

2 types of heat distribution

Floor heating + Domestic Hot Water

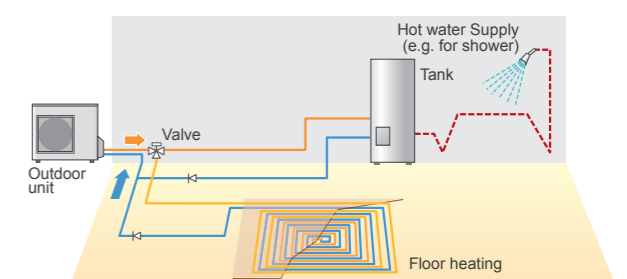





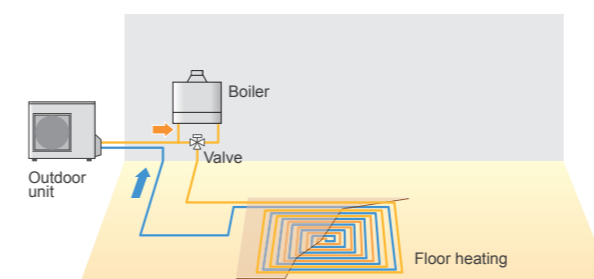







Boiler connected to heating (Boiler + Heating)

Floor heating



# Optional parts

Product Name	Model Name	Split										Monobloc		Split DHW integrated type							
		High Power					Comfort					Compact		High Power				Comfort			
		1Ø		3Ø			1Ø			1Ø		1Ø		1Ø		3Ø		1Ø			
		11	14	11	14	16	5	6	8	10	8	10	11	14	11	14	16	5	6	8	10
2nd Circuit Kit	 UTW-KZSXE	●	●	●	●	●	●	●	●	—	—	—	—	—	—	—	—	—	—	—	
	 UTW-KZDXE	—	—	—	—	—	—	—	—	—	—	●	●	●	●	●	●	●	●	●	
Boiler Connection kit	 UTW-KBSXD	●	●	●	●	●	●	●	●	—	—	—	—	—	—	—	—	—	—	—	
	 UTW-KBDXD	—	—	—	—	—	—	—	—	—	—	●	●	●	●	●	●	●	●	●	
Balancing vessel	 UTW-TEVXA	●	●	●	●	●	●	●	●	●	●	●	●	●	●	●	●	●	●	●	
DHW kit	 UTW-KDWSA	—	—	—	—	—	—	—	—	—	●	●	—*1	—*1	—*1	—*1	—*1	—*1	—*1	—*1	
	 UTW-KDWSX	●	●	●	●	●	●	●	●	—	—	—*1	—*1	—*1	—*1	—*1	—*1	—*1	—*1	—*1	
DHW Expansion Vessel kit	 UTW-KDEXE	—	—	—	—	—	—	—	—	—	—	●	●	●	●	●	●	●	●	●	
DHW tank	 200 Liter 300 Liter UTW-T20XA UTW-T30XA	●	●	●	●	●	●	●	●	●	●	—*1	—*1	—*1	—*1	—*1	—*1	—*1	—*1	—*1	
	 300 Liter UTW-T30XD	●	●	●	●	●	●	●	●	●	●	—*1	—*1	—*1	—*1	—*1	—*1	—*1	—*1	—*1	
	 UTW-PHFXD	●	●	●	●	●	—	—	—	—	—	—	●	●	●	●	—	—	—	—	
Swimming Pool kit	 UTW-KSPXA	●	●	●	●	●	●	●	●	●	●	●	●	●	●	●	●	●	●	●	
	 UTW-KSPXD	●	●	●	●	●	●	●	●	—	—	●	●	●	●	●	●	●	●	●	
Heat Exchanger for swimming pool kit	 UTW-ESPSA	●	●	●	●	●	●	●	●	●	●	●	●	●	●	●	●	●	●	●	
Cooling kit	 UTW-KCLXD	●	●	●	●	●	●	●	●	—*2	—*2	●	●	●	●	●	●	●	●	●	
Regulation Extension Kit	 UTW-KREXD	●	●	●	●	●	●	●	●	—	—	●	●	●	●	●	●	●	●	●	
Solar Regulation Kit	 UTW-KSRXE	●	●	●	●	●	●	●	●	—	—	—	—	—	—	—	—	—	—	—	
Mode Exchange Kit	 UTW-KMEXE	●	●	●	●	●	●	●	●	●	●	●	●	●	●	●	●	●	●	●	
Low Noise Kit	 UTW-KLNXE	●	●	●	●	—	—	—	—	—	—	●	●	●	●	—	—	—	—	—	
HMI Kit	 UTW-KHMXE <sup>5</sup>	●	●	●	●	●	●	●	●	—	—	●	●	●	●	●	●	●	●	●	

Product Name	Model Name	Split										Monobloc		Split DHW integrated type							
		High Power					Comfort					Compact		High Power				Comfort			
		1Ø		3Ø			1Ø			1Ø		1Ø		1Ø		3Ø		1Ø			
		11	14	11	14	16	5	6	8	10	8	10	11	14	11	14	16	5	6	8	10
Remote Controller	Wired 	UTW-C75XA	●	●	●	●	●	●	●	●	●	●	●	●	●	●	●	●	●	●	
		UTW-C75XA-E <sup>5</sup>	●	●	●	●	●	●	●	●	●	●	●	●	●	●	●	●	●	●	●
Remote Controller	Wireless 	UTW-C78XD	●	●	●	●	●	●	●	●	●	●	●	●	●	●	●	●	●	●	
		UTW-C78XD-E <sup>5</sup>	●	●	●	●	●	●	●	●	●	●	●	●	●	●	●	●	●	●	●
Room Thermostat	Wired 	UTW-C55XA	●	●	●	●	●	●	●	●	●	●	●	●	●	●	●	●	●	●	
		UTW-C58XD	●	●	●	●	●	●	●	●	●	●	●	●	●	●	●	●	●	●	●
Outdoor Sensor Transmitter	Wireless 	UTW-MOSXD	●	●	●	●	●	●	●	●	●	●	●	●	●	●	●	●	●	●	
		UTW-M60XD	●	●	●	●	●	●	●	●	●	●	●	●	●	●	●	●	●	●	●
RF Modules	for X60-Port 	UTW-MRCXD	●	●	●	●	●	●	●	●	●	●	●	●	●	●	●	●	●	●	
	for BSB-Port 	UTW-MRCXD	●	●	●	●	●	●	●	●	●	●	●	●	●	●	●	●	●	●	
Web server		UTW-KWSXD	●	●	●	●	●	●	●	●	●	●	●	●	●	●	●	●	●	●	
		UTW-KW1XD UTW-KW4XD	●	●	●	●	●	●	●	●	●	●	●	●	●	●	●	●	●	●	●
Cascade Master Kit (incl. LPB Clip)		UTW-KCMXE	●	●	●	●	●	—	—	—	—	—	—	—	—	—	—	—	—	—	
Cascade Slave Kit (incl. LPB Clip)		UTW-KCSXE	●	●	●	●	●	—	—	—	—	—	—	—	—	—	—	—	—	—	
LPB Clip		UTW-KL1XD	●	●	●	●	●	●	●	●	—	—	●	●	●	●	●	●	●	●	
Base Heater		UTZ-HAMXE	—	—	—	—	—	—	—	—	●	●	—	—	—	—	—	—	—	—	
Service Tool (incl. OCI700 adaptor)		UTW-KSTXD	● <sup>*3</sup>	● <sup>*3</sup>	● <sup>*3</sup>	● <sup>*3</sup>	● <sup>*3</sup>	● <sup>*3</sup>	● <sup>*3</sup>	● <sup>*3</sup>	● <sup>*3</sup>	● <sup>*3</sup>	● <sup>*3</sup>	● <sup>*3</sup>	● <sup>*3</sup>	● <sup>*3</sup>	● <sup>*3</sup>	● <sup>*3</sup>	● <sup>*3</sup>	● <sup>*3</sup>	
Service Tool Software		UTW-KPSXD	● <sup>*4</sup>	● <sup>*4</sup>	● <sup>*4</sup>	● <sup>*4</sup>	● <sup>*4</sup>	● <sup>*4</sup>	● <sup>*4</sup>	● <sup>*4</sup>	● <sup>*4</sup>	● <sup>*4</sup>	● <sup>*4</sup>	● <sup>*4</sup>	● <sup>*4</sup>	● <sup>*4</sup>	● <sup>*4</sup>	● <sup>*4</sup>	● <sup>*4</sup>	● <sup>*4</sup>	

\*1: DHW operation is possible without DHW Kit and DHW Tank. ● : Available — : Not Available  
 \*2: Cooling operation is possible without cooling kit  
 \*3: UTW-KL1XD is required for the connection.  
 \*4: UTW-KSTXD(OCI700 adaptor not included), UTW-KW1XD or UTW-KW4XD is required for the connection.  
 \*5: Eastern European Language(English, Czech Republic, Slovakia, Poland, Turkey, Hungary, Russia, Slovenia, Greece, Serbia)

## Equipment Installation

### Split type Hydraulic unit

- Hydraulic unit is to be hang on the wall
- Weight < 60 kg (including water)
- Space for maintenance should be respected

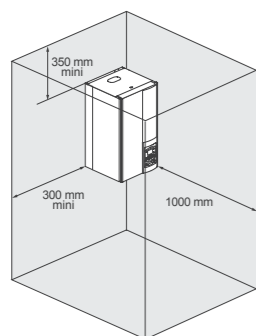

### Split DHW integrated type Hydraulic unit

- Floor stand
- Weight 366 kg (including water)
- Space for maintenance should be respected.

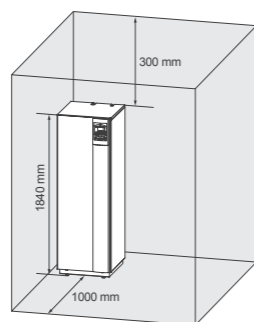

### Monobloc type Outdoor unit

- Floor stand
- Weight 74 kg (without water)
- Distances for maintenance should be kept

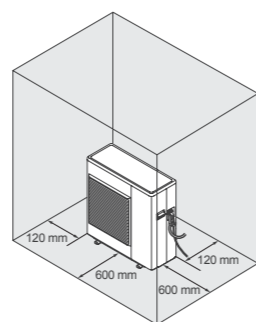

## Piping and Wiring

### Split type

Series	Capacity range(kW)	H (m)	L (m)
Comfort	5	± 15	5-20
	6		
	8		
	10		
High power	11	± 15	5-20
	14		
	16		

### Electrical wiring

#### Split type

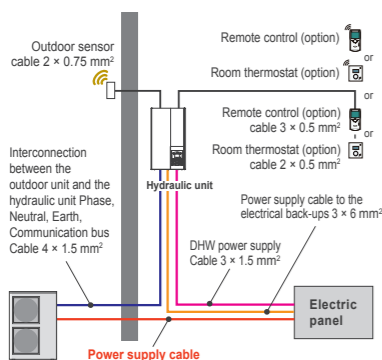

#### Split DHW integrated type

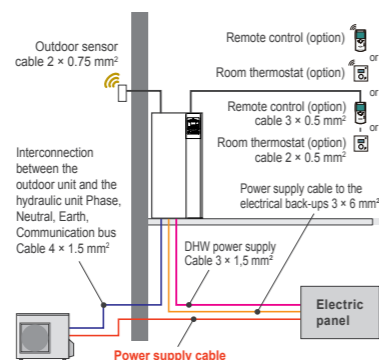

#### Monobloc type

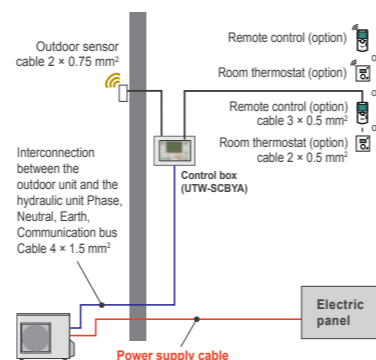

## SPLIT TYPE

Outdoor Units Comfort series :  
WOYA060LDC / WOYA080LDC

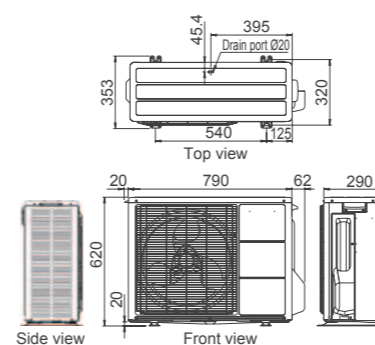

WOYA100LDT

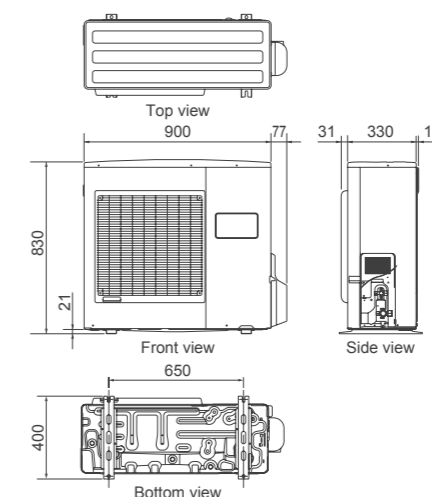

Outdoor Units High Power series :  
WOYK112LCT / WoyK140LCT / WoyK160LCT

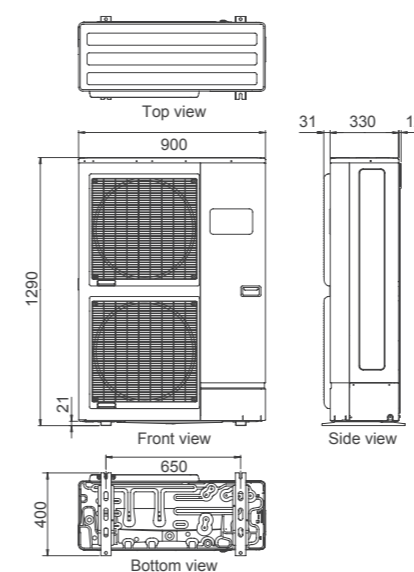

Outdoor Units High Power series :  
WOYG112LCT / WoyG140LCT

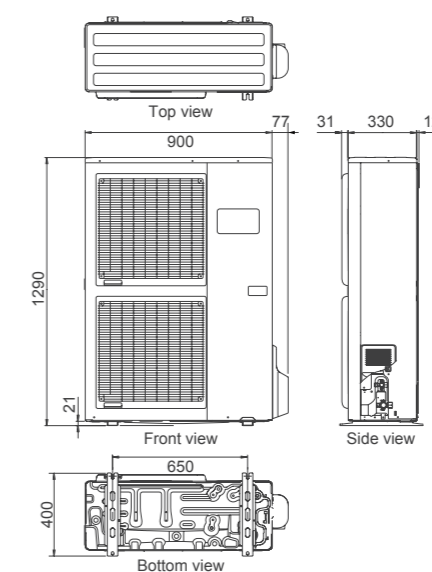

Hydraulic units Split type  
High Power series :  
WSYG140DC6 / WSYK160DC9

Hydraulic units Split type  
Comfort series :  
WSYA050DD6 / WSYA100DD6

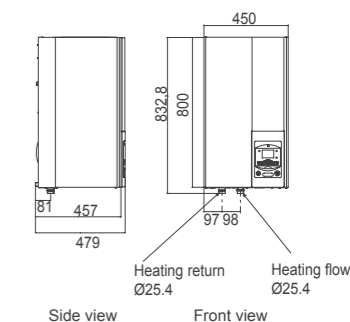

Hydraulic units Split DHW  
integrated type High Power series :  
WGYG140DD6 / WGYK160DD9

Hydraulic units Split DHW  
integrated type Comfort series :  
WGYA050DD6 / WGYA100DD6

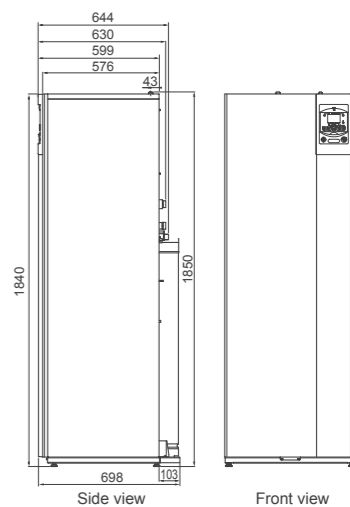

## MONOBLOC TYPE

Compact series :  
WPYA080LE / WPYA100LE

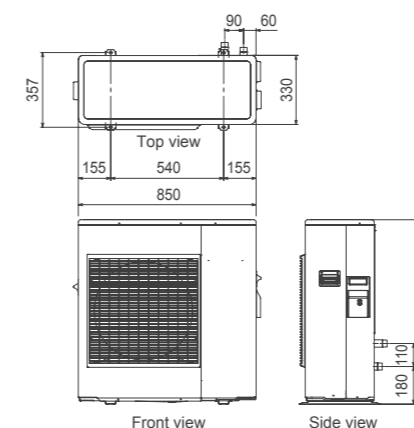

Control Box :  
UTW-SCBYA

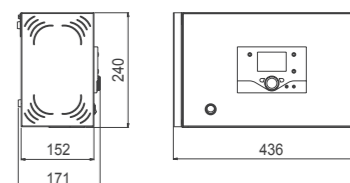

## Split type

Series name			High Power series					Comfort series									
Capacity range (kW)			11	14	11	14	16	5	6	8	10						
+7°C / +35°C floor heating *1	Heating capacity	kW	10.80	13.50	10.80	13.50	15.17	4.50	6.00	7.50	10.00						
	Input power		2.54	3.23	2.51	3.20	3.70	0.996	1.41	1.84	2.49						
	COP		4.25	4.18	4.30	4.22	4.10	4.52	4.27	4.08	4.02						
+2°C / +35°C floor heating *1	Heating capacity	kW	10.77	12.00	10.77	13.00	13.50	4.50	4.95	5.65	7.70						
	Input power		3.44	3.87	3.40	4.15	4.34	1.39	1.53	1.78	2.47						
	COP		3.13	3.10	3.17	3.13	3.11	3.24	3.24	3.17	3.12						
-7°C / +35°C floor heating *1	Heating capacity	kW	10.80	12.00	10.80	13.00	13.50	4.10	4.60	5.70	7.40						
	Input power		4.32	5.08	4.28	5.18	5.40	1.47	1.74	2.23	2.97						
	COP		2.50	2.36	2.52	2.51	2.50	2.79	2.64	2.56	2.49						
+7°C / +45°C radiators *1	Heating capacity	kW	9.23	11.54	10.10	12.60	13.00	4.50	5.10	6.20	8.27						
	Input power		2.84	3.72	3.01	3.81	4.00	1.30	1.50	1.87	2.53						
	COP		3.25	3.10	3.35	3.30	3.25	3.46	3.40	3.31	3.27						
-7°C / +45°C radiators *1	Heating capacity	kW	9.16	11.45	10.02	12.50	13.00	4.10	4.45	5.05	7.40						
	Input power		4.58	5.92	4.63	6.00	6.37	1.86	2.04	2.47	3.70						
	COP		2.00	1.93	2.16	2.08	2.04	2.20	2.18	2.04	2.00						
Backup heater	Capacity	kW×pcs	6.0 (3.0×2pcs.)	6.0 (3.0×2pcs.)	9.0 (3.0×3pcs.)	9.0 (3.0×3pcs.)	9.0 (3.0×3pcs.)	6.0 (3.0×2pcs.)	6.0 (3.0×2pcs.)	6.0 (3.0×2pcs.)	6.0 (3.0×2pcs.)						
Hydraulic unit Model name			WSYG140DC6			WSYK160DC9			WSYA050DD6		WSYA100DD6						
Power source			1Ø 230V, 50Hz			3Ø 400V, 50Hz			1Ø 230V, 50Hz								
Water circulation			Rated	L / min	31.2			39.0	31.2	39.0	43.8	13.00					
Min / Max			25.0 / 50.0			8.1/16.2			10.8/21.7			13.5/27.1					
Dimensions H×W×D			mm			800 × 450 × 457			800 × 450 × 457								
Weight (Net)			kg			42			42								
Buffer tank capacity			L			16			16								
Expansion vessel capacity			L			8			8								
Leaving water temperature range			°C			8 to 60			8 to 55								
Water pipe connection diameter			Flow / Return			mm			Ø25.4 / Ø25.4								
Outdoor unit Model name			WOYG112LCT		WOYG140LCT		WOYK112LCT		WOYK140LCT		WOYA060LDC		WOYA080LDC		WOYA100LDT		
Power source			1Ø 230V, 50Hz			3Ø 400V, 50Hz			1Ø 230V, 50Hz								
Current			Rated	A	11.4			14.2	3.7	4.8	5.5	4.5	6.3	8.1	10.9		
Max			22.0			25.0			8.5			9.5			10.5		
Noise level (Sound pressure)			dB(A)			55 <sup>*2</sup>			56 <sup>*2</sup>			53 <sup>*2</sup>			55 <sup>*2</sup>		
Dimensions H×W×D			mm			1290 × 900 × 330			620 × 790 × 290			830 × 900 × 330					
Weight (Net)			kg			92			99			41			42		
Refrigerant			kg			R410A			R410A								
Refrigerant amount			kg			2.50			1.10			1.40			1.80		
Additional refrigerant charge amount			g/m			50			20			20			40		
Connection pipe			Diameter	mm	Liquid			Ø9.52			Ø6.35			Ø9.52			
Gas			mm			Ø15.88			Ø12.70			Ø15.88					
Length			Min / Max	m	5 / 20			5 / 20			5 / 20						
Length (chargeless)			Max	m	15			15			15						
Height difference			Max	m	15			15			15						
Operation range			Heating			°C			-25 to 35			-20 to 35					

## Split DHW integrated type

Series name			High Power series					Comfort series									
Capacity range (kW)			11	14	11	14	16	5	6	8	10						
+7°C / +35°C floor heating *1	Heating capacity	kW	10.80	13.50	10.80	13.50	15.17	4.50	6.00	7.50	10.00						
	Input power		2.54	3.23	2.51	3.20	3.70	0.996	1.41	1.84	2.49						
	COP		4.25	4.18	4.30	4.22	4.10	4.52	4.27	4.08	4.02						
+2°C / +35°C floor heating *1	Heating capacity	kW	10.77	12.00	10.77	13.00	13.50	4.50	4.95	5.65	7.70						
	Input power		3.44	3.87	3.40	4.15	4.34	1.39	1.53	1.78	2.47						
	COP		3.13	3.10	3.17	3.13	3.11	3.24	3.24	3.17	3.12						
-7°C / +35°C floor heating *1	Heating capacity	kW	10.80	12.00	10.80	13.00	13.50	4.10	4.60	5.70	7.40						
	Input power		4.32	5.08	4.28	5.18	5.40	1.47	1.74	2.23	2.97						
	COP		2.50	2.36	2.52	2.51	2.50	2.79	2.64	2.56	2.49						
+7°C / +45°C radiators *1	Heating capacity	kW	9.23	11.54	10.10	12.60	13.00	4.50	5.10	6.20	8.27						
	Input power		2.84	3.72	3.01	3.81	4.00	1.30	1.50	1.87	2.53						
	COP		3.25	3.10	3.35	3.30	3.25	3.46	3.40	3.31	3.27						
-7°C / +45°C radiators *1	Heating capacity	kW	9.16	11.45	10.02	12.50	13.00	4.10	4.45	5.05	7.40						
	Input power		4.58	5.92	4.63	6.00	6.37	1.86	2.04	2.47	3.70						
	COP		2.00	1.93	2.16	2.08	2.04	2.20	2.18	2.04	2.00						
Backup heater	Capacity	kW×pcs	6.0 (3.0×2pcs.)	6.0 (3.0×2pcs.)	9.0 (3.0×3pcs.)	9.0 (3.0×3pcs.)	9.0 (3.0×3pcs.)	6.0 (3.0×2pcs.)	6.0 (3.0×2pcs.)	6.0 (3.0×2pcs.)	6.0 (3.0×2pcs.)						
Hydraulic unit Model name			WGYG140DD6			WGYK160DD9			WGYA050DD6		WGYA100DD6						
Power source			1Ø 230V, 50Hz			3Ø 400V, 50Hz			1Ø 230V, 50Hz								
Water circulation			Rated	L / min	31.2			39.0	31.2	39.0	43.8	13.00					
Min / Max			25.0 / 50.0			8.1/16.2			10.8/21.7			13.5/27.1					
Dimensions H×W×D			mm			1840 × 648 × 698			1840 × 648 × 698								
Weight (Net)			kg			152			152								
DHW capacity			L			190			190								
Hot water heater capacity			kW			1.5			1.5								
Buffer tank capacity			L			16			16								
Expansion vessel capacity			L			12			12								
Leaving water temperature range			°C			8 to 60			8 to 55								
Water pipe connection diameter			Flow / Return			mm			Ø25.4 / Ø25.4								
Hot water pipe diameter			mm			(Inlet/Outlet) Ø19.05			(Inlet/Outlet) Ø19.05								
Outdoor unit Model name			WOYG112LCT		WOYG140LCT		WOYK112LCT		WOYK140LCT		WOYA060LDC		WOYA080LDC		WOYA100LDT		
Power source			1Ø 230V, 50Hz			3Ø 400V, 50Hz			1Ø 230V, 50Hz								
Current			Rated	A	11.4			14.2	3.7	4.8	5.5	4.5	6.3	8.1	10.9		
Max			22.0			25.0			8.5			9.5			10.5		
Noise level (Sound pressure)			dB(A)			55 <sup>*2</sup>			56 <sup>*2</sup>			53 <sup>*2</sup>			55 <sup>*2</sup>		
Dimensions H×W×D			mm			1290 × 900 × 330			620 × 790 × 290			830 × 900 × 330					
Weight (Net)			kg			92			99			41			42		
Refrigerant			kg			R410A			R410A								
Refrigerant amount			kg			2.50			1.10			1.40			1.80		
Additional refrigerant charge amount			g/m			50			20			20			40		
Connection pipe			Diameter	mm	Liquid			Ø9.52			Ø6.35			Ø9.52			
Gas			mm			Ø15.88			Ø12.70			Ø15.88					
Length			Min / Max	m	5 / 20			5 / 20			5 / 20						
Length (chargeless)			Max	m	15			15			15						
Height difference			Max	m	15			15			15						
Operation range			Heating			°C			-25 to 35			-20 to 35					

## Monobloc type

Series name			Compact series			
Capacity range (kW)			8	10		
+7°C / +35°C floor heating *1	Heating capacity	kW	8.00	10.00		
	Input power		1.78	2.30		
	COP		4.50	4.35		
+2°C / +35°C floor heating *1	Heating capacity	kW	7.40	8.10		
	Input power		2.73	3.00		
	COP		2.71	2.70		
-7°C / +35°C floor heating *1	Heating capacity	kW	7.10	8.00		
	Input power		2.93	3.32		
	COP		2.42	2.41		
+7°C / +45°C radiators *1	Heating capacity	kW	7.80	9.80		
	Input power		2.23	2.88		
	COP		3.50	3.40		
-7°C / +45°C radiators *1	Heating capacity	kW	6.50	7.00		
	Input power		2.98	3.31		
	COP		2.18	2.11		
Monobloc unit Model name			WPYA080LE		WPYA100LE	
Power source			1Ø 230V, 50Hz			
Water circulation			Rated	L / min	22.9	
Min / Max			10.0 / 30.0		10.0 / 30.0	
Current			Rated	A	8.30	
Noise level (Sound pressure)			dB(A)		51 <sup>*2</sup>	
Dimensions H×W×D			mm			
Weight (Net)			kg			
Water pipe connection diameter			Flow / Return			
mm			Ø25.4 / Ø25.4			
Refrigerant			R410A			
Refrigerant amount			kg			
Leaving water temperature range			°C			
Operation range			Heating			
°C			-20 to 35			

\*1. The values of heating capacity/power input/COP are based on measurement of EN14511 standard. Usage environment, such as operation of the heating equipment, room temperature, and controller adjustments, may cause disparities between practically determined values and spec. values and these values.  
\*2. Sound pressure level measured at distance of 1m from the device.

# FEATURE EXPLANATION

## Comfortable Function

- Human sensor**  
Human sensor catches movements of people in a room.
- Up / down swing flaps**  
The up / down flaps automatically swing up and down.
- Double swing automatic**  
Complex swing action of flaps enables automatically to swing both horizontal and vertical directions.
- Automatic air flow adjustment**  
The micro-computer automatically adjusts the air flow effectively to follow the changes of room temperature.
- Auto restart**  
In the event of a temporary power failure, the air conditioner will automatically restart in the same operating mode as before, once the power supply is restored.
- Auto-changeover**  
The unit automatically switches between heating and cooling modes based on your temperature setting and the room temperature.
- 10°C HEAT operation**  
The room temperature can be set to go no lower than 10°C, thus ensuring that the room does not get too cold when not occupied.
- Connectable distributing duct**
- Connectable fresh air duct**
- Fresh air intake**  
Fresh air can be taken in by a fan which can be connected using external control unit.
- Economy mode**  
Limits the maximum operation current, and performs operation with the power consumption suppressed.
- Powerful mode**  
Operation at maximum air flow and compressor speed, and quickly makes the room comfortable.
- Low Noise Mode**  
Sound noise level of outdoor unit can be selected.

**V-PAM control models**

**i-PAM control models**

## Convenient Function

- Sleep timer**  
The micro-computer gradually changes the room temperature automatically to afford a comfortable night's sleep.
- Program timer**  
This digital timer allows selection of one of four options: ON, OFF, ON → OFF or OFF → ON.
- Weekly timer**  
Different ON-OFF times can be set for each day.
- Weekly + setback timer**  
Weekly + Setback timer can set temperature for two times spans and for each day of the week.
- Filter sign**  
Indicates the filter cleaning period by lamp.

## Clean Function

- Ion deodorization filter**  
The filter deodorizes by powerfully decomposing absorbed odors using the oxidizing and reducing effects of ions generated by the ultra-fine-particle ceramic.
- Apple-catechin filter**  
The Apple-catechin filter uses static electricity to clean fine particles and dust in the air.
- Washable panel**

## Feature Summary

	Wall Mounted	Floor	Compact Cassette / Cassette	Floor/Ceiling	Ceiling	Slim Duct	Medium Static Pressure Duct	High Static Pressure Duct
	ASYG09/12/LTCA	ASYG07/09/12/14/LUCA	ASYG07/09/12/14/LMCA	ASYG07/09/12/LCC	AGYG09/12/14/LJCA	AUYG12/14/18/LVLB, AUYG24/LVCA	AUYG30/36/LRLE, AUYG38/45/54/LRLA	ABYG18/LVTB, ABYG24/LVTA
						ABYG30/36/LRTE, ABYG38/45/54/LRTA	ARYG24/36/45/LMLA, ARYG30/36/LMLE	ARYG45/54/60/LHTA, ARYC72/90/LHTA
<b>Comfortable function</b>								
Human sensor	●							
Up / down swing flaps	●	●	●	●	●	●	○	
Double swing automatic				●			●	●
Automatic air flow adjustment	●	●	●	●	●	●	●	●
Auto restart	●	●	●	●	●	●	●	●
Auto-changeover	●	●	●	●	●	●	●	●
10°C heat operation	●	●	●	●	●	○	●	○
Connectable distributing duct						●		●
Connectable fresh air duct						○	●	○
Fresh air intake						○	○	○
Economy mode	●	●	●	●	●	●	●	●
Powerful mode	●	●	●	●	●			
Low Noise mode	●	●	●				○ (45/54) (36/LRLA)	○ (45/54) (36/LRTA)
							○ (45) (36/LMLA)	○ (60)
<b>Convenient function</b>								
Sleep timer	●	●	●	●	●	●	○	○
Program timer	●	●	●	●	●	●	○	○
Weekly timer	●	●						
Weekly + setback timer	○	○	○	○	○	○	●	●
Filter sign	●	●	●	●	●	●	●	●
<b>Clean function</b>								
Ion deodorization filter	●	●	●	●	●	●		
Apple-catechin filter	●	●	●	●	●	●		
Washable panel		●	●	●	●	●		

○: Optional function