

2014

multiPANEL

the c o l l e c t i o n



**waterproof
walls,
floors &
ceilings**



white matt ceiling**PANEL**
riven marble/ slate multi**PANEL**
ice hydro**STONE**
sicilia twin**FLOOR**click

multi**PANEL**

the c o l l e c t i o n

...for the home & for the trade

The **multiPANEL** collection is a family of waterproof walls, floors and ceilings ideal for **bathrooms, shower areas, kitchens** and all around the home. Easy to install and even easier to maintain, the cost-effective ranges offer endless opportunities for both renovation and new-build.

Grant Westfield has an enviable reputation in the manufacture of commercial cubicles, wall lining and access systems*. Based on this experience and knowledge, the **multiPANEL** collection has been designed to meet the needs of the commercial market.

* for further information please contact our marketing department, or visit www.grantwestfield.co.uk

white slate **tilePANEL** , honey **hydroSTONE**

WALLS

multi PANEL	4
tile PANEL	6
poly PANEL	8
clean PANEL	9

FLOORS

twin FLOOR stick	10
twin FLOOR click	12

CEILINGS

ceiling PANEL	14
----------------------	----

VANITIES

multi PANEL vanity tops	16
hydro STONE	17

FINISHING TOUCHES

sound PANEL	18
twin FLOOR accessories	19
multi PANEL	20
shower/bath kits	21

COLOURS

Colour ranges	22-27
---------------	-------

white ash ceiling**PANEL**
monsoon multi**PANEL**
rimini twin**FLOOR**click



multiPANEL

the luxury alternative to tiling

WALLS

Whether you are fed up of tile grouting, or are simply looking for a new and fresh look for your bathroom, **multiPANEL** waterproof wall panels provide the perfect solution. Our selection of 32 decors range from traditional stones, to sparkles, to striking modern designs, in gloss and textured finishes.

The panels can be applied to timber battens or directly bonded to the wall, with a range of aluminium sections permitting quick and easy installation. Our precisely engineered Hydro-lock tongue and groove joint (see p.20) allows a tight and discrete joint to be created between panels. Watertight sealing of **multiPANEL** is achieved using silicone sealant at all joints.

As an alternative to using end caps, panels can be lipped with a PVC edging to compliment your chosen décor. Bath/shower tray seal kits, access kits, high grab adhesive and sealant and all-in-one kits for showers or baths (see p.20-21) are all available to order. In addition to bathrooms, the versatile and durable panels are suitable for a variety of domestic and commercial applications.



METAL SECTION RANGE

Type A Internal Corner

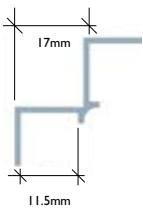

Type B External Corner

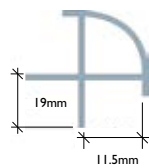

Type C End Cap (L shaped)

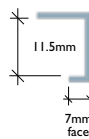

Type D Mid Joint

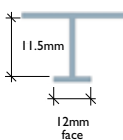

Type E Quadrant End Cap

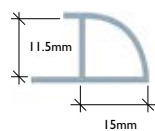

Type X Base Profile

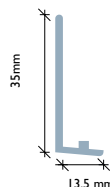

Supplied in 2.45m lengths, see p.25 for colours

- ✓ No more grouting!
- ✓ WBP plywood core
- ✓ Durable, waterproof system
- ✓ Quick to install
- ✓ Clean and hygienic

TECHNICAL INFORMATION

- 9mm WBP plywood core
- Bonded with decorative face and white balancer high pressure laminate
- 2400 x 1200 x 11mm (nominal 8' x 4') available from stock
- Panels can be cut to any size
- Allowances to be made for Hydro-lock T&G panels (see p.20)
- Available in 32 colours (see p.22)

white sparkle ceiling**PANEL**
white tile**PANEL** (bevelled)
black tile**PANEL** (embossed, mosaic)
black marble twin**FLOOR**stick



tilePANEL

tile effect waterproof walls

tilePANEL is designed with simulated tile effects, allowing you to enjoy the authentic look of tiles without the inconvenience of grout. As the completely waterproof panels are only 3mm thick, they are perfect for fitting over existing tiles for an attractive, cost-effective refurbishment.

The panels are manufactured with two styles of grout lines that ensure mould free surfaces, with minimal maintenance; the embossed, square tile version is supplied on double-faced panels, with a small glossy tile on one side, and a larger matt tile on the reverse. The bevelled tilePANEL comes with a 30 x 20cm rectangular tile on single-faced panels. See p.24 for our choice of colours.

tilePANEL can be either be ordered in individual panels and profiles, or as an all in one shower kit (see p. 21). High grab panel adhesive and silicone sealant is also available to order.



black slate tilePANEL (embossed, mosaic /large)

METAL SECTION RANGE

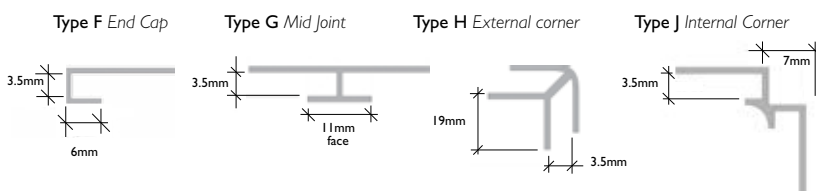

Supplied in 2.45m lengths. See p.25 for colours

- ✓ 3 tile sizes
- ✓ Install over existing tiles
- ✓ Completely waterproof
- ✓ Only 3mm thick
- ✓ Authentic tile effects

TECHNICAL INFORMATION

- 3mm compact grade laminate.
- Tactile, simulated tile effects
- 2440 x 1220mm
- Embossed tile
 - Mosaic (gloss) 23.5x23.5mm with 3mm grout line
 - Large (matt) 47x47mm with 4mm grout line
- Bevelled tile
 - XL (gloss) 300x200mm with 4mm grout line
- Colour/tile size availability – see p.24

polyPANEL

the economic, PVC wall panel

polyPANEL combines the practical benefits of waterproof wall panels instead of wall tiles, with economy. Manufactured in rigid PVC in six popular designs, the 1m wide panels are supplied with a tongue and groove joint as standard, enabling the quick and simple creation of budget wall cladding.

PVC SECTION RANGE

Type U End Cap

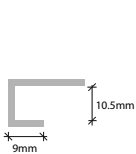

Type V Internal Corner

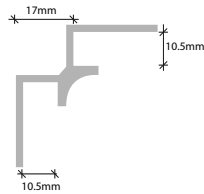

Type W External Corner

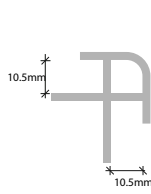

Supplied in 2.4m lengths. See p.25 for colours

TECHNICAL INFORMATION

- 10mm PVC
- Tongue and groove panels
- 2400 x 1000 x 10mm as standard
- Class 1 fire rating
- Available in 6 colours (see p.25)

roman marble polyPANEL



- ✓ Economic
- ✓ Completely waterproof
- ✓ Class 1 fire rating
- ✓ Moisture resistant

obsidian marble polyPANEL



WALLS



- ✓ Over 3m high
- ✓ Class 1 fire rating
- ✓ Only 3mm thick
- ✓ Double-sided

cleanPANEL

the extra height solution for hygienic walls

For areas over 2400mm high, **cleanPANEL** is the ideal wall panel at 3050 x 1220mm. Floor to ceiling installations are made easy with aluminium corner, jointing and end cap sections.

Manufactured to BS EN 438 standards, and with a class 1 spread of flame fire rating and 10 year warranty, **cleanPANEL** is ideal for sanitary areas, laboratories, clean rooms as well as in the home, as the chemical resistant, smooth face simply wipes clean.



METAL SECTION RANGE

Type Q End Cap

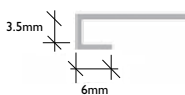

Type R Mid Joint

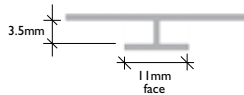

Type S External Corner

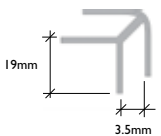

Type T Internal Corner

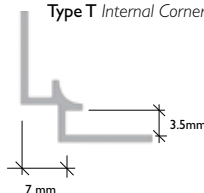

Supplied in 3.05m lengths. See p.25 for colours

TECHNICAL INFORMATION

- 3mm compact grade laminate
- Double sided panels- gloss white/ matt white
- 3050 x 1220 x 3mm



blizzard/ twilight multi**PANEL**
white gloss **vanity top**
flagstone twin**FLOORstick**

twinFLOOR[®]stick

the floating, self-bond vinyl floor

twinFLOORstick is a waterproof vinyl flooring range consisting of two layers with an innovative overlapping GlueStrip assembly. This enables quick and simple fitting without the cost associated with installation of comparable quality vinyl floors.

With a 0.3mm wear layer; and hard-wearing surface, twinFLOORstick tiles and planks are perfect for domestic and light commercial waterproof flooring. To make the most of twinFLOORstick, home-care kits are available to order (see p.19).



canadian cedar twinFLOORstick

Fitting twinFLOORstick really is as simple as...



- ✓ Overlapping GlueStrip assembly
- ✓ No adhesive required
- ✓ Easy to cut and fit
- ✓ Completely waterproof
- ✓ Replace individual tiles/planks

TECHNICAL INFORMATION

- 3.8mm vinyl
- 0.3mm wear layer
- R10 slip resistance
- 2.23m² coverage per pack
- Wood planks supplied in packs of 16 pieces, each 36" x 6" (914 x 152mm)
- Wood planks are supplied with a micro-bevelled edge
- Tiles are supplied in packs of 8 pieces, each 36" x 12" (914 x 304mm)
- Available in 10 colours; 5 wood plank and 5 tile effect (see p. 26)



matt white ceiling**PANEL**
travertine multi**PANEL**
american walnut twin**FLOOR**click

twinFLOOR[®]click

the floating, self-lock vinyl floor

twinFLOORclick is the latest generation of floating vinyl flooring from Grant Westfield, and combines the benefits of twinFLOORstick with the new 'EasyClic' locking profile for a fast, dry installation. The waterproof floor has a tough 0.5mm wear layer and is coated with ceramic beads for added wear and durability, making it ideal for commercial as well as domestic use.

twinFLOORclick planks are manufactured with bevelled edges and with a deep, registered embossing to create an authentic real wood effect. twinFLOORclick tiles are available in beautiful natural stone patterns and come with a bevel that adds clarity and distinction to the finished effect. To ensure complete engagement of the inter-locking planks and tiles, the **LOCKBLOCK** is available to order (see p.19)



Fitting twinFLOORclick really is as simple as...

Angle



Slide



Lock

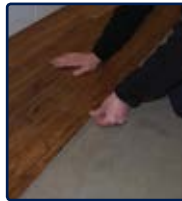

Tap



- ✓ Inter-locking assembly
- ✓ Glue free installation
- ✓ Commercial grade
- ✓ Quick and simple to lay
- ✓ Completely waterproof

TECHNICAL INFORMATION

- 5.0mm vinyl
- 0.5mm wear layer
- R10 slip resistance
- 1.84m² coverage per pack
- Wood planks supplied in packs of 8 pieces, each 1210 x 190mm
- Tiles are supplied in packs of 10 pieces, each 605 x 304mm
- Available in 10 colours; 5 wood plank and 5 tile effect (see p. 26)

white ash ceiling**PANEL**
kalahari multi**PANEL**



ceilingPANEL

the light and easy PVC ceiling

ceilingPANEL provides a moisture resistant, decorative alternative to painting ceilings, eliminating the possibility of flaking paint in bathrooms. The tongue and groove panels are quick and easy to install, wipe clean in seconds and are the ideal partner for the Grant Westfield wall panelling ranges.

ceilingPANEL profiles allow neat perimeters to be created, and can be used as decorative in-fills between panels. With an opaque face, ceilingPANEL is suitable for domestic and commercial applications.



ceilingPANEL is supplied in tongue & groove panels which simply slot together.

PVC SECTION RANGE

Type K Mid Joint

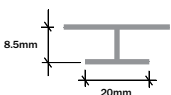

Type L End Cap

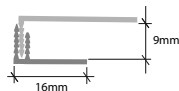

Type M Ceiling Mould

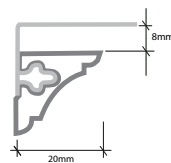

Type N Internal Corner

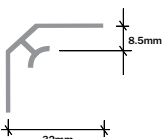

Type O External Corner

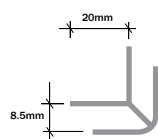

Type P Clip-in Trim

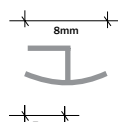

Supplied in 2.7m lengths. See p.25 for colours

TECHNICAL INFORMATION

- 8mm rigid PVC
- Class 1 surface spread of flame
- 2700 x 250mm tongue and grooved panels
- 2.7m² coverage per pack
- Do not use in areas subject to temperatures over 60°C (keep out of direct sunlight)
- Available in 6 colours (see p.25)

- ✓ Impervious to moisture
- ✓ Class 1 fire rating
- ✓ Tongue and groove assembly
- ✓ Easy to handle and install
- ✓ Economic



multiPANEL vanity tops bull-nosed shelving elements

Simple, elegant and durable, **multiPANEL vanity tops** are available in 27 matching **multiPANEL** finishes. The option to contrast or co-ordinate with **multiPANEL** or **tilePANEL** wall panels produces stunning results.

multiPANEL vanity tops allow you to create beautiful vanity and shelving areas, and the gentle rolled front edge offers a unique blend of warmth and luxury certain to complement any bathroom suite.

TECHNICAL INFORMATION

- 25mm MR MDF core
- Bonded with post-forming grade laminate and white balancing laminate
- 2400 x 380 x 27mm as standard
- Tops can be cut to size or manufactured to a greater depth than 380mm
- Available in 27 **multiPANEL** colours (denoted as V on p. 22-23)



travertine vanity top

hydroSTONE

solid surface vanity tops

hydroSTONE is a premium bathroom surface solution constructed from solid modified acrylic, boasting the striking finish solid surface material is renowned for; at the competitive price you expect from the **multiPANEL** collection. At 25mm deep, and with 3mm radiused edges and corners completing a stunning visual appeal, **hydroSTONE** is certain to enhance any bathroom. The versatile surface is most commonly used as a vanity top for back-to-wall furniture, and to create feature shelving.

Whilst **hydroSTONE** solid surface tops are harder than wood or laminate, they can be cut with a jig saw, with bowl cut-outs and radiused edges created with a router. What's more, the pattern runs throughout the material, therefore should scratching occur; they can be sanded out to preserve the beautiful finish.

TECHNICAL INFORMATION

- 25mm solid modified acrylic
- 2110 x 370 x 25mm as standard
- Supplied as 'blanks' without bowl cut-outs
- Available in 5 designs (see p.27)



cracknel hydroSTONE



liquorice hydroSTONE

For singing in the shower...



- ✓ MP3/iPod compatible
- ✓ Built in radio amp
- ✓ Compatible with external audio sources
- ✓ Touch-pad or remote control



Say good-bye to suction pad radios falling on your feet in the shower! And say hello to the sophisticated future of bathroom audio. With **soundPANEL**, 2 gel-audio™ speakers are attached to the back of a wall or ceiling panel, reverberating sound waves through the panel core - effectively turning it into a speaker!

A **soundPANEL** kit comes complete with built-in FM radio, and is MP3 compatible. No visible wires, no apertures, no grilles - just stunning panel finishes and 100% concealed, high quality audio!

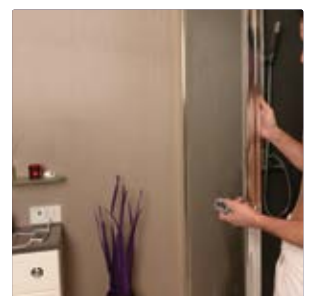

PACK CONTENTS

- 2 Gel Audio Speaker Units
- 20 Watt (RMS) per channel amp with built in FM Radio
- Power supply
- Input jack fitted socket
- 10m speaker cable
- 0.5m jack to jack cable
- Remote Control
- Full installation instructions

twinFLOOR accessories



twinFLOORstick homecare kits

Once your new **twinFLOORstick** has been laid, you will naturally want to preserve its beautiful appearance and condition. Our home-care kit will allow you to ensure best installation, preservation, and in case of damage, reparation of **twinFLOORstick**.

CONTENTS

- seam roller
- 1 L **twinFLOOR** polish/cleaner
- 5m repair tape
- felt furniture protectors
- care and maintenance guidelines



LOCKBLOCK

LOCKBLOCK has been specifically designed to be used with **twinFLOORclick** to ensure complete engagement of the inter-locking profile. The edge detail of **LOCKBLOCK** slides into and over the tongue and groove edge profile of **twinFLOORclick**, allowing you to tap along the full length of each plank or tile, without damaging your flooring.

Look how easy it is!

Visit www.multipanel.co.uk or scan the code below to view our online demos for hints and tips for laying your floor, along with other **multiPANEL** collection products. Full installation guidelines can be viewed as e-books or downloaded.



HYDRO-LOCK

To join two panels together without a Type D mid-joint, **multiPANEL** can be manufactured with our precisely engineered hydro-lock edge detail to create an extremely tight, almost invisible joint.

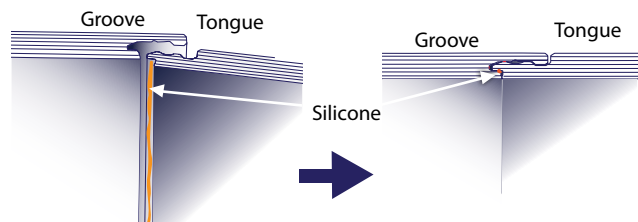

TECHNICAL INFORMATION

- When manufacturing hydro-lock joints, 18.5mm is lost from the original panel width, e.g.
2400x598mm = 2400x579.5mm finished face size
2400x1200mm = 2400x1181.5mm finished face size
- Hydro-lock panels are supplied as standard with a tongued edge and a grooved edge
- Hydro-lock panels should be conditioned at normal room temperature for 48-72 hours prior to installation, particularly during cold spells.
- Panels should be fitted 'grooved' edge first, and the 'tongued' edge of the next panel angled in and pushed back until it snaps into place.
- A narrow bead of silicone sealant must be applied to the shoulder of the 'tongue'
- Accuracy of pattern alignment between panels may vary depending on the scale of the pattern
- Hydro-lock panels are not available off the shelf – slightly longer lead times than standard panels apply
- Full fitting instructions should be read prior to installation.

multiPANEL accessories



multiPANEL seal

multiPANEL seal is a two part shower tray and bath sealing system comprising a PVC strip and a high performance white silicone. The 'movement joint' expands and contracts to offer a stylish and reliable bottom seal for **multiPANEL**.

- Flexible
- Durable
- Hygienic
- Attractive



PANEL adhesive and sealant

Grant Westfield High Grab Panel Adhesive is suitable for use on **multiPANEL**, **tilePANEL**, **polyPANEL**, **cleanPANEL**, **ceilingPANEL** and most materials including non-porous surfaces. The high-grab, solvent free adhesive can also be used as a white silicone sealant.

Sealux-N Silicone sealant is also available to order from Grant Westfield in white or clear finishes.



multiPANEL access

This all-in-one kit allows you to create quick and easy access to all your services.

Simply cut your **multiPANEL** access, using the card template on the inside of the packaging as a guide, or create your own shape. The flexible extrusion and concealed screw fixing seal the panel, but permit quick, simple access to any of your services.

PACK INCLUDES

- 2 strips (1.85m each)
- 2 sealant
- 2 end caps
- 1 mitre block
- 1 spatula & 3 wipes
- full installation instructions

CONTENTS

- Grant Westfield High-Grab Panel Adhesive
290ml
- Sealux-N Silicone Sealant
310ml

PACK INCLUDES

- 1 metre length seal extrusion
- 1 metre length double sided tape
- 'panel lock' and screws
- saw blade and cutting guide
- full installation instructions

KITS

Everything you need to install **multiPANEL** & **tilePANEL** around baths and showers in one simple kit.

multiPANEL Kits

Shower Kit Ⓐ Ⓑ Ⓒ

(2-sided shower)

Panel dimensions: 2400 x 1200mm or 2400 x 900mm

CONTENTS

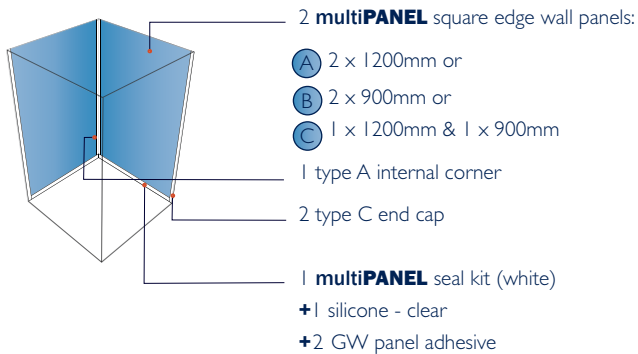

Wall Kit Ⓔ

(bath or walk-in shower)

Panel dimensions: 2400 x 598mm

CONTENTS

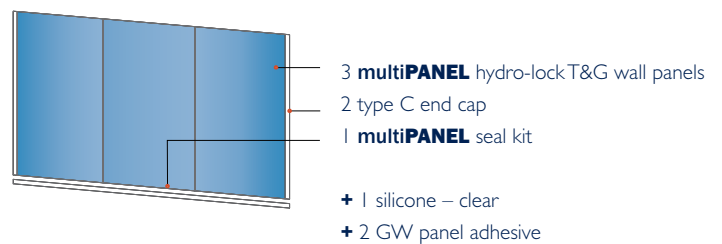

End Kit Ⓓ Ⓔ (3-sided/walk-in shower; & baths) Panel dimensions: 2400 x 1200mm or 2400 x 900mm

CONTENTS

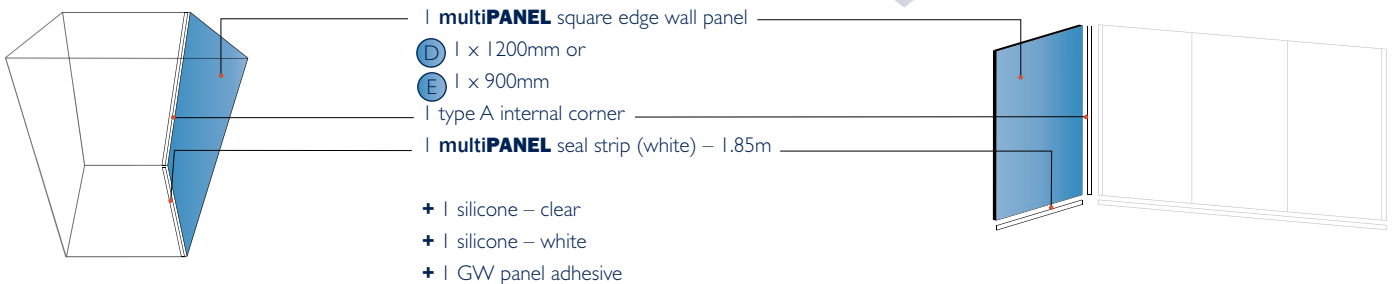

tilePANEL Kits

Shower Kit Ⓖ

(2-sided shower) Panel dimensions: 2440 x 1220mm

CONTENTS

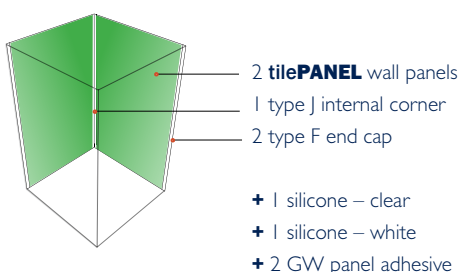

End Kit Ⓕ

(3-sided shower) Panel dimensions: 2440 x 1220mm

CONTENTS

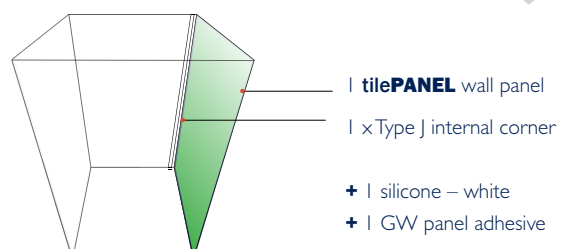

COLOURS

multiPANEL the luxury alternative to tiling

STANDARD

G - Gloss Finish **T** - Textured **V** - available as vanity tops



Umber Brocade 290



Taupe Brocade 275



Kalahari 372



Sahara 476



White Linen 350



Patina Bronze 0794



Antique Marble 701



Sandstone 7184

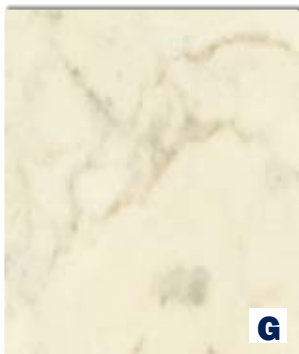

Grey Marble 139H



Classic Marble 141H



Beige Eiger PP5080



Blue Eiger PP5081



White 85G



Black 80HG



Red Pearl 1911

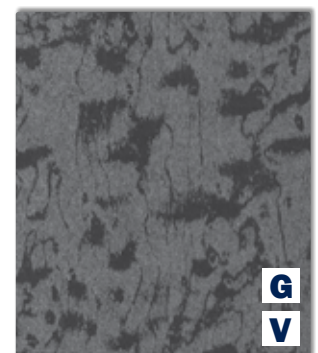

Black Ice 042

The colour samples shown here are a representation of the actual finish, from a small part of a panel. Colour, pattern and scale may vary on a full sized panel. Please check with samples from Grant Westfield Ltd or your local distributor.

PREMIER



Riven Slate 2859

T
V



Riven Marble 924I

T
V



Urban Stone 047

T
V



Monsoon 433

T
V



Travertine 3526

G
V

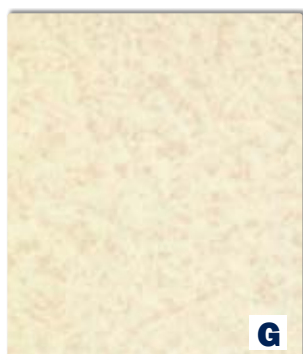

Natural India 194H

G



Limestone 7182

G
V



Platinum Wave 944

T
V



Glacier PP5703

G
V



Sezanne Pearl 369H

G
V



Frost White 049

G
T*
V

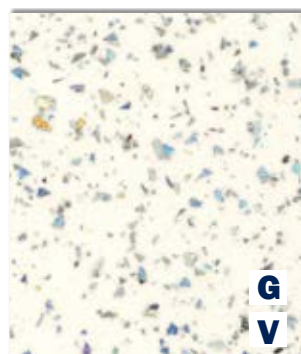

Blizzard 030

G
V



Veneto 410HG

G
V



Moonstone 717I

G
V

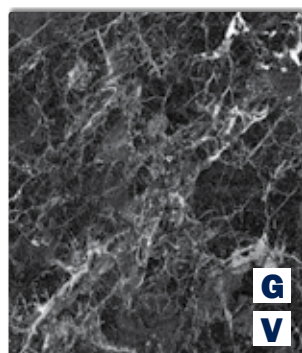

Midnight Stone 0379

G
V

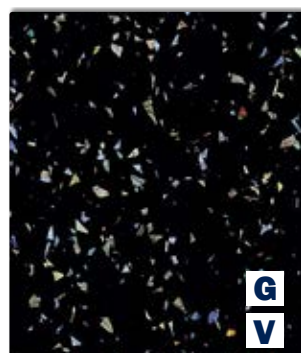

Twilight 033

G
V

* Frost White is available in a velour finish as a special order – longer lead times apply

COLOURS

tile**PANEL** tile effect waterproof walls

bevelled tile effect Panels are single-faced with a 30 x 20cm gloss tile



embossed tile effect Panels are double-faced with a 23.5 x 23.5mm small gloss tile on one side, and a 47 x 47mm matt tile on the reverse.

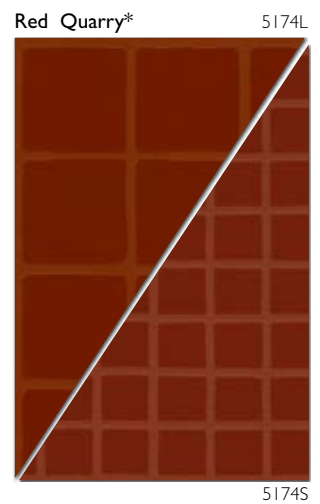
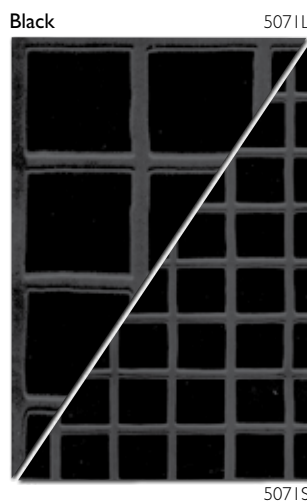
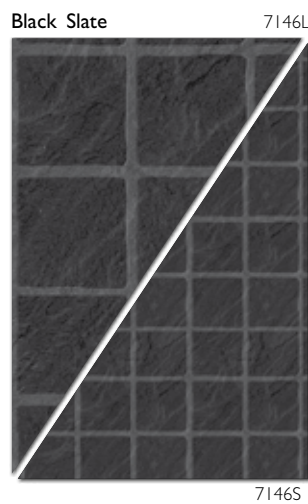
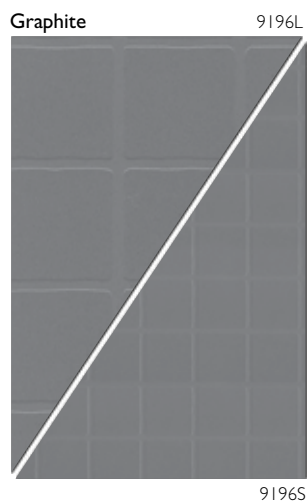
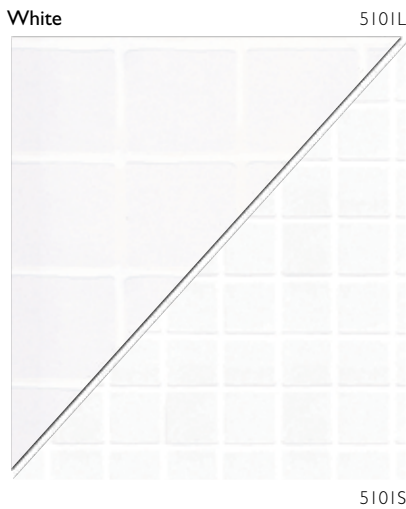

The samples shown here are a representation of the actual tile pattern size and colour and are not always 100% accurate. Please check with sample swatches from Grant Westfield Ltd or your local distributor.

*Red Quarry will be discontinued once existing stock has been used. Please check stock prior to placing an order

polyPANEL the economic PVC wall panel

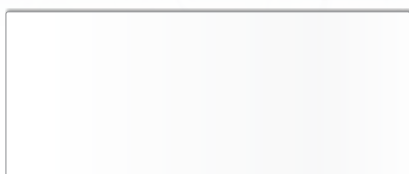

Snow Drift

MPPSD



Roman Marble

MPPRM



Byzantine Marble

MPPBM

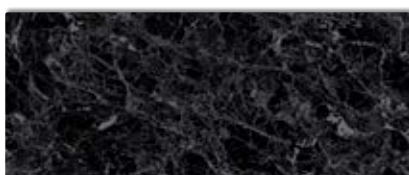

Obsidian Marble

MPPOM



Sunlit Quartz

MPPSQ



Moonlit Quartz

MPPMQ

All polyPANEL decors are supplied in a high gloss finish.

ceilingPANEL the light and easy PVC ceiling

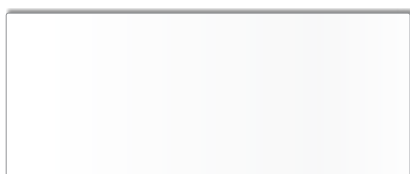

White Gloss

MCPGW



White Matt

MCPMW



White Ash

MCPWA



Pergamon Marble

MCPPM



White Sparkle

MCPWS



Soft Grey Marble

MCPSGM

All ceilingPANEL decors apart from Matt White and White Ash are supplied in a high gloss finish.

PROFILES

	multiPANEL	tilePANEL	polyPANEL	cleanPANEL	ceilingPANEL	
 White	✓	✓	✓	✓	✓	
 Black	✓	✓	✓			
 Satin Anodised Silver	✓*	✓		✓		* Type X profile is only available in satin anodised silver
 Bright Polished Silver	✓	✓	✓****		✓**	** Type P profile is only available in bright polished silver *** Type M profile (silver) is supplied with two narrow silver strips above and below the white cove profile **** A section of white PVC is visible between the silver foil and the polyPANEL, therefore silver profiles are not recommended with Moonlit Quartz or Obsidian Marble.

COLOURS

twinFLOOR[®]stick
the floating, self-bond vinyl floor

twinFLOOR[®]click
the floating, self-lock vinyl floor

Embossing
A – Satin
B – Riven
C – In Register
D – Barnside
E – Hand-scraped



Black Marble *MTFBM*



White Marble *MTFWM*



Ivory Shale *MTFIS*



Sand Shale *MTFSS*



Flagstone *MTFFS*

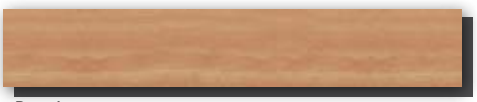

Beech *MTFBH*



Canadian Cedar *MTFCC*



Natural Oak *MTFNO*



Red Oak *MTFRO*



African Mahogany *MTFAM*



Campania Travertine
MTFCAM



Toscana Marble
MTFCTOS



Lombardia Marble
MTFCLOM



Rimini
MTFCRIM



Sicilia
MTFCSIC



American Walnut *MTFCAME*



Sherwood Oak *MTFCSHE*



Markham Oak *MTFCMAR*



Aspen Oak *MTFCASP*



Classic Oak *MTFCCLA*

The amount of pattern on twinFLOORclick tiles varies between tiles to ensure the most realistic effect is created across the whole installation. Therefore the printed samples above may not represent the overall effect once the floor is laid. Throughout this brochure, colour samples and photographs used are a representation of the actual colour and are not always 100% accurate. Please check all colours with sample swatches from Grant Westfield Ltd or your local distributor. Grant Westfield reserve the right to change the range of colours available.

hydroSTONE solid surface vanity tops



Ice

MHSICE



Honey

MHSHON

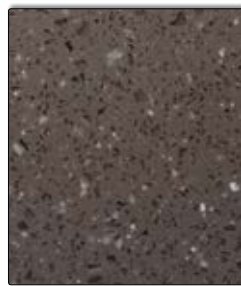

Toffee

MHSTOF

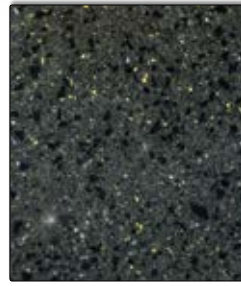

Cracknel

MHSCRA



Liquorice

MHSLIQ

multiPANEL vanity tops bull-nosed shelving elements

Please refer to the multiPANEL decors denoted **V** on p.22-23.

PICTURE IT...

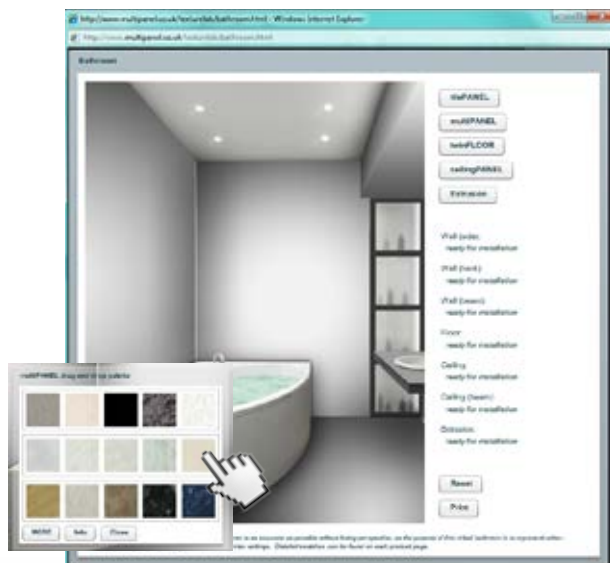

We appreciate that your multiPANEL collection products form an integral part of an important purchase, and you may need reassurance that they will look the way you imagined. That's why we have created a virtual bathroom on www.multipanel.co.uk, where you can also request colour samples and find your local showroom/distributor.

Once you have decided on your colour scheme and the products are installed, you can enter our 'your photos' competition - please visit our web site for further details, terms and conditions.



PERFORMANCE & WARRANTY

In compliance with the Construction Products Regulation 2011, all applicable multiPANEL collection products supplied from 1st July 2013 will be CE marked in accordance with the relevant harmonised European standard (hEN). Declarations of performance are available on www.multipanel.co.uk.

We aim to ensure you are fully satisfied with your purchase, and therefore stress the importance of reading our installation guidelines prior to installation. Given the diversity of our product range, a number of different factors must be considered and addressed for each product before and during installation, such as storage, conditioning, inspection for flaws/damage, sub-surface preparation, sealing panels and rolling of floor joints. Our 10 year* warranty covers the unlikely failure of the product, and will be invalid if any of our published guidelines are deemed not to have been followed. Installation guidelines and full details on each product warranty can be downloaded from www.multipanel.co.uk, or e-mailed, faxed or posted on request.

*multiPANEL, tilePANEL, polyPANEL, cleanPANEL, ceilingPANEL, twinFLOORstick, twinFLOORclick and hydroSTONE all carry a 10 year warranty. multiPANEL vanity tops carry a 2 year warranty, with 1 year for multiPANELaccess, multiPANELseal and soundPANEL.

multi**PANEL** the collection

A family of waterproof products ideal for...

Bathrooms

Showers

Kitchens

Hotels

Education

Sport & leisure

STD_0114



Branches in

Peterhead
Edinburgh (HQ)
Livingston
Prudhoe
Ballynahinch
Wakefield
Leicester
Bishop's Stortford
Basingstoke



This brochure is printed on FSC accredited paper and in a chemical free printing process

Grant Westfield Limited Westfield Avenue Edinburgh EH11 2QH
orders@grantwestfield.co.uk or samples@grantwestfield.co.uk
t +44 (0)131 337 6262 f +44 (0)131 337 9241

www.multipanel.co.uk

Grant Westfield
building interiors