



# Bay Shelving

Storage Solutions

☎ 01745 570348

info@bayshelving.co.uk

## STORAGE CATALOGUE

2014



**NEW**

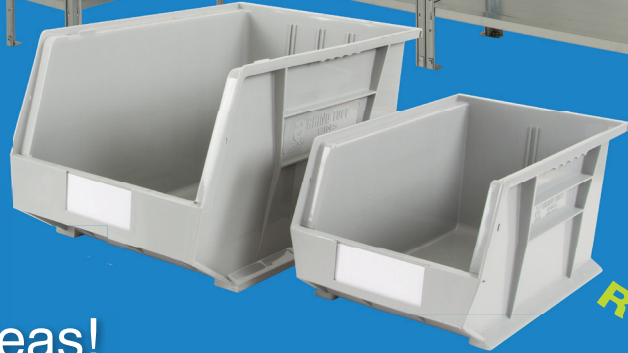

  
Recycled

**100s**  
of Storage Ideas!

Guaranteed   
**5 Day Delivery**

**FREE Delivery\***

\* Mainland England & Wales Only



**NEW**



[www.bayshelving.co.uk](http://www.bayshelving.co.uk)

### Clicka Shelving

4-7

<b>Clicka 175 Shelving</b>	4 - 5
<b>Clicka 265 Shelving</b>	6 - 7



Our new **CLICKA** system is simple to erect yet has all the strength you are likely to need. Made in Europe and tested to the highest standards.

### Trucks & Trolleys

74-83

<b>Sack Trucks</b>	74 - 77
<b>Platform &amp; Shelf Trolleys</b>	78 - 79
<b>Steps &amp; Ladders</b>	80 - 83



### Rivet Racking Systems

8-23

<b>Rivet shelving</b>	8 - 15
<b>Z Rivet shelving</b>	16 - 17
<b>J Rivet Shelving</b>	18 - 19
<b>Z Rivet Compartment Bays</b>	20 - 21
<b>Archive Shelving</b>	22 - 23



Our best selling system offering strength, versatility all at a competitive price and delivered free within 5 days.

### Plastic Storage Containers

84-99

<b>Plastic Picking Bins</b>	84 - 95
<b>Plastic Shelf Trays</b>	96 - 97
<b>Euro &amp; Distribution Containers</b>	98 - 99



Whether it's picking small parts or distributing valuable items we have a huge range of bins and containers to solve any material handling problem.

### Steel Shelving Systems

24-45

<b>Expo 4 Boltless Shelving</b>	24 - 29
<b>Expo 3 Galvanised Shelving</b>	30 - 35
<b>Delta Edge Shelving</b>	36 - 37
<b>Idea 5 Shelving</b>	38 - 39
<b>Chrome Wire Shelving</b>	40 - 45



A range of steel shelving systems, available in painted or galvanised and to suit any application or budget.

### Anti-Static Solutions (ESD)

100-101

<b>ESD Plastic Storage Bins</b>	100
<b>ESD Chrome Wire Shelving</b>	101



ESD Plastic Containers and Chrome Wire Shelving which solve the problems of static electricity damaging sensitive electronic devices.

### Long & Bulky Storage

46-57

<b>Midspan Galvanised Shelving</b>	46 - 47
<b>Heavy Longspan Shelving</b>	48 - 51
<b>Pallet Racking</b>	52 - 53
<b>Cantilever Racking</b>	54 - 55
<b>Vertical Racking</b>	56 - 57

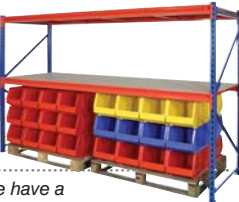

If you have to store long or bulky items then we have a solution to suit any problem, from boxes to large pallets as well as storing goods either vertical or horizontal.

### Lockers

102-103

<b>Lockers and Personal Storage</b>	102 - 103
-------------------------------------	-----------



An Industrial range of steel lockers and cupboards in a range sizes delivered within 5 days.

### Workbench & Tables

58-67

<b>Rivet Style Workbench</b>	58 - 59
<b>Heavy Duty Workbenches</b>	60 - 62
<b>Drawer Cabinets</b>	63
<b>Picking &amp; Packing Benches</b>	64 - 65
<b>Mobile Workbenches</b>	66 - 67



A range of Packing and Picking stations, Workbenches and Mobile Workbenches to suit any application or environment.

### Labelling & Recycling

104-105

<b>Labelling &amp; Recycling</b>	104 - 105
----------------------------------	-----------



Make product identification a whole lot easier with our range of magnetic and self-adhesive ticket/label holders, magnetic location markers and self-adhesive numbers and letters.

### Platform Trolleys

68-73

<b>Platform Trolleys</b>	68 - 73
--------------------------	---------



### Industrial Mesh Partitioning

106-107

<b>Mesh Partitions</b>	106 - 107
------------------------	-----------



Mesh industrial partitioning is the ideal solution when you need to create safe and secure areas within warehouse or storeroom.

## Nationwide Delivery



## Delivery

All prices are inclusive of delivery to the areas indicated in the schedule below. All orders under £150 are subject to a £6.95 small order charge. Goods shall be delivered within 5 days from payment, if available from stock. Delivery will be to a ground floor location and heavy items may require fork lift unloading and/or assistance on site. Delivery is to a business address Monday to Friday 8.30am to 5.00pm. Restricted delivery areas or residential addresses may incur a surcharge.

## Prices

All quoted prices are exclusive of VAT at the prevailing rate.

## Important

All racking systems are supplied flat packed for assembly on site. Weights and loading are based on UDL (uniformly distributed loads). If the height to depth ratio is more than 4 : 1 then the racking should be secured to the floor or wall.

### Delivery Zones & Codes

Area	5 Day	Next Day
Mainland England and Wales	Free	P.O.A
Scotland (Only TD, DG, EH, ML, KA, KY, G)	plus £15.00	P.O.A
Rest of Scotland (FK, PA, DD, PH, AB, IV, KW, HS)	P.O.A	P.O.A
All Islands	P.O.A	P.O.A

page 6

from **£119.<sup>50</sup>**



page 12

from **£183.<sup>40</sup>**

**NEW**



page 38

from **£58.<sup>50</sup>**

**NEW**



page 99

from **£8.<sup>50</sup>**



**NEW**

## New 175kgs Clicka Shelving Range

Our new CLICKA 175 system offers a shelving system with shelf loads of 175kgs at an unbeatable price. This is our best value shelving - ever! It is simple to erect yet has all the strength you are likely to need, as well as being tested and certified to the highest European standards - GS TUV. The bays come with chipboard decking which offers a smooth and hard wearing finish, strong upright and beam profiles, all finished in a high quality paint finish.

### Key Features & Benefits



- ★ **New low cost shelving system**  
New 175kgs capacity shelving systems at our lowest price
- ★ **Superior quality at a low price**  
Heavy duty - Fully tested and certified by GS TUV
- ★ **Fast 48 hour delivery**  
There when you want it – without fail
- ★ **Easy to assemble and re-configure**  
Organise all your storage problems fast
- ★ **Will suit any application**  
A versatile range, ideal for home, office, garage or store



Locate beam in position

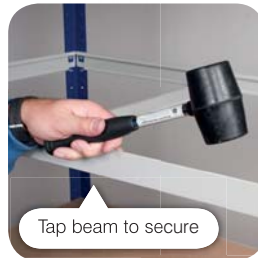

Tap beam to secure

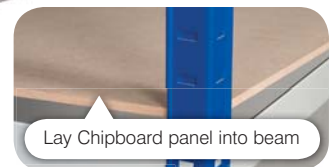

Lay Chipboard panel into beam

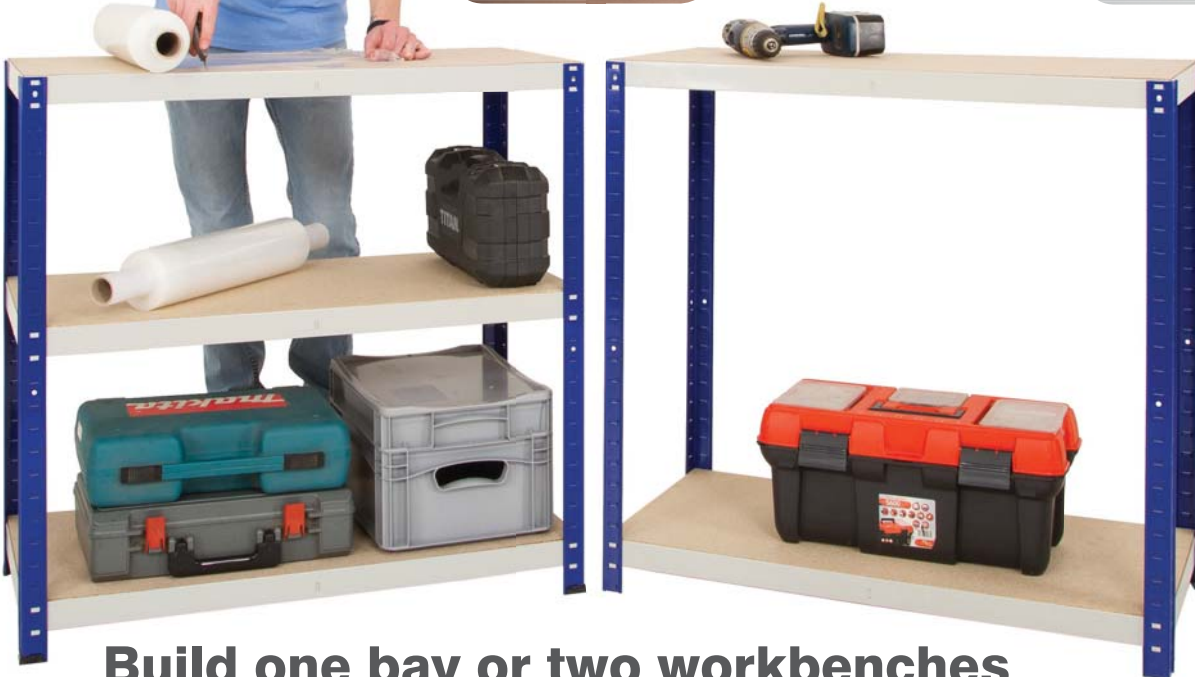

### Build one bay or two workbenches



# Our lowest price shelving - ever



**Bays c/w 5 shelves**

Size (mm) H x W x D	Code	Shelf Load (kg)	Price
1770 x 900 x 300	CL175A/BGC	175	£51.80
1770 x 900 x 450	CL175B/BGC	175	£58.70
1770 x 900 x 600	CL175C/BGC	175	£66.15

**Accessories**



Rubber mallet



Gloves

Item	Code	Price
<b>Rubber Mallet</b>		
	MALLET	£3.30
<b>Safety Glove</b>		
	SGLOVE	£2.25

To order please see back cover



## Clicka 265 Shelving Range

Our Clicka 265 system is simple to erect yet has all the strength you are likely to need. Shelf loads of 265kgs UDL which have been tested and certified to the highest European standards. The bays come with mdf decking which offers a smooth and hard wearing finish, strong upright and beam profiles, all finished in a high quality paint finish.



### Key Features & Benefits

- ★ **Heavy Duty low cost shelving system**  
A brand new concept at exceptional value
- ★ **Superior quality at a low price**  
Heavy duty - Fully tested and certified
- ★ **Fast 48 hour delivery**  
There when you want it – without fail
- ★ **Easy to assemble and re-configure**  
Organise all your storage problems fast
- ★ **Will suit any application**  
A versatile range, ideal for home, office, garage or store

### Accessories



Item	Code	Price
Rubber Mallet	MALLET	£3.30
Safety Glove	SGLOVE	£2.25



Have you seen...

**Signs and labels** p.104

### Bays c/w 5 shelves

Size (mm) H x W x D	Code	Loading UDL per shelf	Price
1770 x 900 x 300	CL265A/BG	265kgs	£62.55
1770 x 900 x 450	CL265B/BG	265kgs	£70.95
1770 x 900 x 600	CL265C/BG	265kgs	£79.65
1770 x 1200 x 300	CL265D/BG	265kgs	£73.20
1770 x 1200 x 450	CL265E/BG	265kgs	£83.50
1770 x 1200 x 600	CL265F/BG	265kgs	£94.45



**Great Value  
Archive Storage**



**Build a bay in under  
10 minutes with just  
a rubber mallet!**



Locate beam in position



Tap beam to secure



Lay MDF panel into beam

**Archive Storage Bay**

Size (mm) H x W x D	Shelf Levels	Code	Quantity of boxes	Price
1770 x 1200 x 450	5	CL265E/AK15	15	£119.50

To order please see back cover



# RIVET RACKING - WIDESPAN

## Key Features and Benefits:

- ★ **Best Selling System**  
Offers the widest choice of sizes, all at great value.
- ★ **Guaranteed delivery in 5 days**  
There when you need it, without fail.
- ★ **Large open bays**  
Store your large bulky items with ease.
- ★ **Strong and Sturdy**  
With shelf capacities up to 500kgs it easily copes with heavy goods.
- ★ **Easy to build and reconfigure**  
Quickly get your storage problem solved, simply tap together with a rubber mallet!
- ★ **No fixings - No fuss**  
No fiddly nuts, bolts or fixings - quick and easy.

## Have you seen...



**Clicka Shelving** p.4 - 5



## The Rivet Racking System:

Rivet Racking uses a central deck support which not only supports the chipboard panel but ties the two face beams together. All components are joined via the heavy duty rivet and key hole slot. A simple and effective way to assemble racking.



Deck support on all levels



Tie Plate







## Rivet Racking

Offers incredible value for money, whilst offering amazing strength and rigidity

The system is yet simple to build with all parts being tapped together by a rubber mallet. All components are joined via the heavy duty rivet and key hole slot which offers a simple and effective way to assemble the racking.

All bays come with 4 levels which have a central deck support on bays 1220 to 2135 wide, while 2440mm wide bays have two per level, providing that secret strength to all our RIVET bays.

### Colours available:

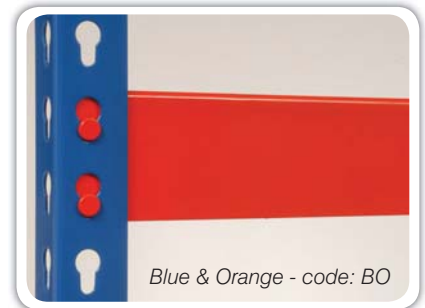
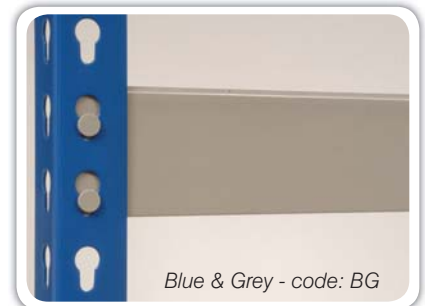

See p10-11 for Heavy Rivet Short Span...

### All bays c/w 4 shelves

Size (mm)	Code	Shelf Load (kg)	Bay Price	Shelf Code	Additional Shelf Price
1830 x 1830 x 305	RRB/18/18/03/4	500	£156.00	RRS/18/03	£32.25
1830 x 1830 x 457	RRB/18/18/04/4	500	£175.10	RRS/18/04	£37.00
1830 x 1830 x 610	RRB/18/18/06/4	500	£195.60	RRS/18/06	£42.15
1830 x 1830 x 762	RRB/18/18/07/4	500	£215.80	RRS/18/07	£47.20
1830 x 1830 x 915	RRB/18/18/09/4	500	£243.75	RRS/18/09	£54.20
1830 x 1830 x 1220	RRB/18/18/12/4	500	£289.75	RRS/18/12	£65.65
1830 x 2135 x 305	RRB/18/21/03/4	450	£176.45	RRS/21/03	£37.35
1830 x 2135 x 457	RRB/18/21/04/4	450	£204.40	RRS/21/04	£44.35
1830 x 2135 x 610	RRB/18/21/06/4	450	£221.30	RRS/21/06	£48.55
1830 x 2135 x 762	RRB/18/21/07/4	450	£244.40	RRS/21/07	£54.35
1830 x 2135 x 915	RRB/18/21/09/4	450	£275.00	RRS/21/09	£62.00
1830 x 2135 x 1220	RRB/18/21/12/4	450	£323.60	RRS/21/12	£74.15
1830 x 2440 x 305	RRB/18/24/03/4	400	£199.30	RRS/24/03	£43.05
1830 x 2440 x 457	RRB/18/24/04/4	400	£226.15	RRS/24/04	£49.80
1830 x 2440 x 610	RRB/18/24/06/4	400	£251.70	RRS/24/06	£56.15
1830 x 2440 x 762	RRB/18/24/07/4	400	£280.50	RRS/24/07	£63.35
1830 x 2440 x 915	RRB/18/24/09/4	400	£315.50	RRS/24/09	£72.10
1830 x 2440 x 1220	RRB/18/24/12/4	400	£369.80	RRS/24/12	£85.70

All bays come with uprights, plastic feet, perimeter beams, deck supports & 18mm chipboard decking

### For taller bays, simply add the following prices

Extra Height	Code	Price
bays 2135mm	RRB/21/--/--/4	£4.20
bays 2440mm	RRB/24/--/--/4	£8.60
bays 2745mm	RRB/27/--/--/4	£13.00
bays 3050mm	RRB/30/--/--/4	£18.00
bays 3660mm	RRB/36/--/--/4	£25.80

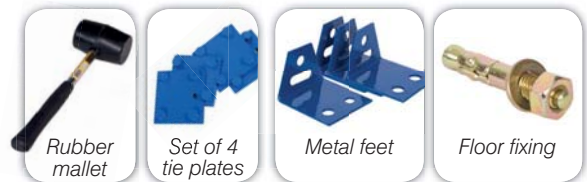

Item	Code	Price
<b>Tie Plate</b>		
Set of 4	RR8/SET4	£3.40
<b>Metal Feet</b>		
Set of 4	RR5/SET4	£3.80
<b>Floor Fixing</b>		
M8 x 50 floor fixing (each)	FFM8	£0.85
<b>Rubber Mallet</b>		
	MALLET	£3.30
<b>Safety Gloves</b>		
	SGLOVE	£2.25

## Rivet Racking

Offers incredible value for money, whilst offering incredible strength and rigidity

The system is yet simple to build with all parts being tapped together by a rubber mallet. All components are joined via the heavy duty rivet and key hole slot which offers a simple and effective way to assemble the racking.

All bays come with 4 levels which have a central deck support on bays 1220 to 2135 wide, while 2440mm wide bays have two per level, providing that secret strength to all our RIVET bays.

Colours available:

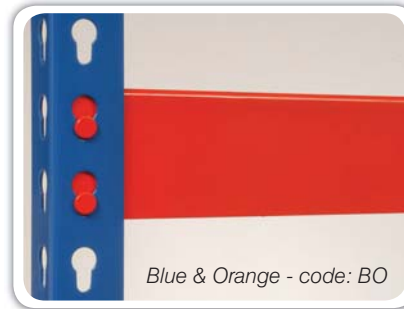

### Key Features and Benefits:

- ★ **Best Selling System**  
Offers the widest choice of sizes, all at great value.
- ★ **Guaranteed delivery in 5 days**  
There when you need it, without fail.
- ★ **Large open bays**  
Store your large bulky items with ease.
- ★ **Strong and Sturdy**  
With shelf capacities up to 600kgs it easily copes with heavy goods.
- ★ **Easy to build and reconfigure**  
Quickly get your storage problem solved, simply tap together with a rubber mallet!
- ★ **No fixings - No fuss**  
No fiddly nuts, bolts or fixings - quick and easy.

See p8-9 for Heavy Rivet Wide Span...



### All bays c/w 4 shelves

Size (mm)	Code	Shelf Load (kg)	Bay Price	Shelf Code	Additional Shelf Price
1830 x 915 x 305	RRB/18/09/03/4	600	£83.15	RRS/09/03	£14.05
1830 x 915 x 457	RRB/18/09/04/4	600	£93.05	RRS/09/04	£16.50
1830 x 915 x 610	RRB/18/09/06/4	600	£102.75	RRS/09/06	£18.90
1830 x 915 x 762	RRB/18/09/07/4	600	£121.20	RRS/09/07	£23.55
1830 x 915 x 915	RRB/18/09/09/4	600	£140.35	RRS/09/09	£28.35
1830 x 915 x 1220	RRB/18/09/12/4	600	£166.10	RRS/09/12	£34.75
1830 x 1220 x 305	RRB/18/12/03/4	550	£103.60	RRS/12/03	£19.15
1830 x 1220 x 457	RRB/18/12/04/4	550	£116.80	RRS/12/04	£22.45
1830 x 1220 x 610	RRB/18/12/06/4	550	£147.60	RRS/12/06	£30.15
1830 x 1220 x 762	RRB/18/12/07/4	550	£154.65	RRS/12/07	£31.90
1830 x 1220 x 915	RRB/18/12/09/4	550	£178.00	RRS/12/09	£37.75
1830 x 1220 x 1220	RRB/18/12/12/4	550	£213.85	RRS/12/12	£46.70
1830 x 1525 x 305	RRB/18/15/03/4	500	£116.40	RRS/15/03	£22.35
1830 x 1525 x 457	RRB/18/15/04/4	500	£129.60	RRS/15/04	£25.65
1830 x 1525 x 610	RRB/18/15/06/4	500	£160.40	RRS/15/06	£33.35
1830 x 1525 x 762	RRB/18/15/07/4	500	£182.40	RRS/15/07	£38.85
1830 x 1525 x 915	RRB/18/15/09/4	500	£203.95	RRS/15/09	£44.20
1830 x 1525 x 1220	RRB/18/15/12/4	500	£245.10	RRS/15/12	£54.50

All bays come with uprights, plastic feet, perimeter beams, deck supports & 15mm chipboard decking

### For taller bays, simply add the following prices

Extra Height	Code	Price
bays 2135mm	RRB/21/--/--/4	£4.20
bays 2440mm	RRB/24/--/--/4	£8.60
bays 2745mm	RRB/27/--/--/4	£13.00
bays 3050mm	RRB/30/--/--/4	£18.00
bays 3660mm	RRB/36/--/--/4	£25.80

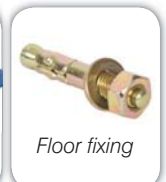

### Tie Plate

Set of 4	RR8/SET4	£3.40
----------	----------	-------

### Metal Feet

Set of 4	RR5/SET4	£3.80
----------	----------	-------

### Floor Fixing

M8 x 50 floor fixing (each)	FFM8	£0.85
-----------------------------	------	-------

### Rubber Mallet

	MALLET	£3.30
--	--------	-------

### Safety Gloves

	SGLOVE	£2.25
--	--------	-------





from  
**£83.<sup>15</sup>**

### Have you seen...

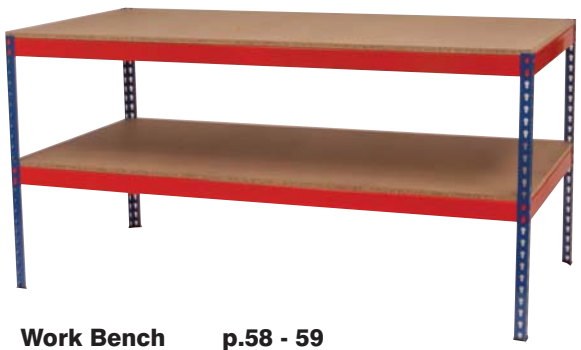

**Work Bench** p.58 - 59



*Tie Plate*



*Simply tap down the beams*

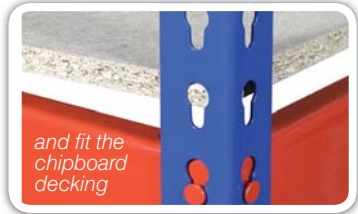

*and fit the chipboard decking*

To order please see back cover   

## Rivet Racking Cable Reel Storage

A new solution for organising and dispensing cable or items stored on drums. The simple side beam that supports a 25mm diameter tube which can hold a variety of drums or reels. The beam is notched so the tubes can be located in 5 different positions. Each level is then fitted with a face beam to enable the material to be offered to the user and conveniently cut to length. The units can come as either static racks or as a low level mobile trolley. The bays come either 915 or 1220mm wide and 610mm deep.

### Cable reel rack - 1830mm high

Size H x W x D	Code	Tube load (kg)	Bay Price
1830 x 915 x 610	RRCB/18/09/06/4/GY	70	£183.40
1830 x 1220 x 610	RRCB/18/12/06/4/GY	60	£234.00

### Cable reel trolley

Size H x W x D	Code	Tube load (kg)	Bay Price
915 x 915 x 610	RRCT/09/09/06/2/GY	70	£273.15

### Key Features and Benefits:

- ★ **Get organised quickly**  
Keeps the workplace safe and well organised
- ★ **Simple and cost effective**  
All made from off the shelf components - no costly bespoke manufacturing
- ★ **Easy to build and reconfigure**  
Simply tap together and lay the tubes into the required slot
- ★ **Strong and Sturdy**  
Made from Rivet Racking components for proven quality and performance



5 different positions for the tube



**Mobile Cable Reel Rack**



Braked castors for additional safety

# Rivet Racking Garment Storage

The perfect storage solution for any bulk garment hanging requirement. All constructed from Rivet racking components for simplicity and ease of assembly. The 25mm zinc coated tube slots into place and can be located in five different positions. This can provide a single rail centrally positioned or two rails located on each face of the rack provide twice the capacity. Each storage level can be adjusted every 38mm easily with just a rubber mallet.

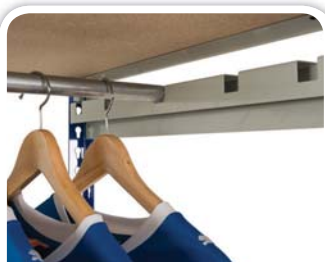

Locate the rail in 5 different positions



Single Rail

Double Rail

### Single rail garment bay - 2 levels

Size H x W x D	Code	Tube load (kg)	Bay Price
2135 x 915 x 610	RRGB/SG/21/09/06/2/GY	70	£78.95
2135 x 1220 x 610	RRGB/SG/21/12/06/2/GY	60	£97.45

### Double rail garment bay - 2 levels

Size H x W x D	Code	Tube load (kg)	Bay Price
2135 x 915 x 610	RRGB/DG/21/09/06/2/GY	70	£96.95
2135 x 1220 x 610	RRGB/DG/21/12/06/2/GY	60	£124.35



### Have you seen...



**Longspan  
Garment  
Racking  
p.50**





## Express Medium Rivet Bays

Need to solve your storage problems quickly and save money? Then our Express Medium Rivet is the answer. This is our best value wide span system ever with two shelf sizes in three heights, all with an incredible 275kgs shelf capacity. These bays are ready for immediate despatch and will be delivered in 48 hours.

### Key Features & Benefits

- ★ Our best value wide span system ever
- ★ Guaranteed 48 hour delivery
- ★ A massive 275kgs shelf load
- ★ Easy tap together assembly

### Bays c/w 3 shelves

Size (mm) H x W x D	Code	Shelf Load/Kgs	Price
1830 x 1830 x 457	EXMR/18/18/04/3	275	£103.20
1830 x 1830 x 610	EXMR/18/18/06/3	275	£115.20

### Bays 1830mm wide x 457mm one box deep

Size (mm) H x W x D (Height to top box)	Code	Complete with Archive boxes	Price
1830 x 1830 x 457mm (1966mm)	MRAK/18/18/30	30	£190.00

Shelf capacity = 275 kgs UDL





## Medium Duty Rivet Racking

### Our best value Rivet Racking

Our Medium Rivet uses a lighter 1830mm "L" shape beam that offers loads up to 300kgs. This provides a more cost effective option for storing long or bulky items.

The bays are available in depths from 305mm to 1220mm deep and any of the standard upright heights from the Heavy duty range.

The uprights are blue and beams light grey and each level comes with a central deck support and 18mm chipboard decking.

### Key Features and Benefits:

- ★ Great value for money
- ★ Guaranteed delivery in 5 days
- ★ Large open bays
- ★ Strong and Sturdy
- ★ Easy to build and reconfigure
- ★ No fixings - No fuss

### Medium Duty Rivet Racking:

These bays offer a versatile and cost effective solution to storage problems.

See p10-11 for Heavy Rivet Short Span...



Bays c/w 4 shelves					
Size (mm)	Code	Shelf Load (kg)	Bay Price	Shelf Code	Additional Shelf Price
1830 x 1830 x 305	MRB/18/18/03/4	300	£129.15	MRS/18/03	£25.50
1830 x 1830 x 457	MRB/18/18/04/4	300	£148.30	MRS/18/04	£30.30
1830 x 1830 x 610	MRB/18/18/06/4	300	£168.75	MRS/18/06	£35.40
1830 x 1830 x 762	MRB/18/18/07/4	280	£189.00	MRS/18/07	£40.50
1830 x 1830 x 915	MRB/18/18/09/4	250	£216.90	MRS/18/09	£47.45
1830 x 1830 x 1220	MRB/18/18/12/4	230	£262.90	MRS/18/12	£58.95

All bays come with uprights, plastic feet, perimeter beams, deck supports & 18mm chipboard decking

For taller bays add the prices below		
bays 2135mm	MRB/21/--/--/4	£4.20
bays 2440mm	MRB/24/--/--/4	£8.60
bays 2745mm	MRB/27/--/--/4	£13.00
bays 3050mm	MRB/30/--/--/4	£18.00
bays 3660mm	MRB/36/--/--/4	£25.80

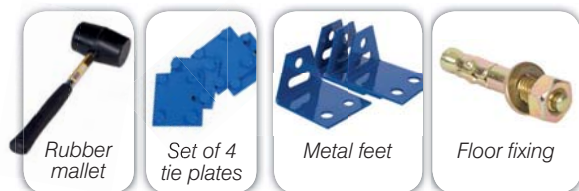

Item	Code	Price
<b>Tie Plate</b>		
Set of 4	RR8/SET4	£3.40
<b>Metal Feet</b>		
Set of 4	RR5/SET4	£3.80
<b>Floor Fixing</b>		
M8 x 50 floor fixing (each)	FFM8	£0.85
<b>Rubber Mallet</b>		
	MALLET	£3.30
<b>Safety Gloves</b>		
	SGLOVE	£2.25

**BEST  
SELLER**



## Key Features and Benefits:

- ★ New Z Profile beam
- ★ Increased storage capacity
- ★ Versatile and flexible system
- ★ Easy to build and reconfigure
- ★ Cost effective storage

## Have you seen...



**Heavy Duty Plastic Storage**  
**Reinforced side walls to**  
**stop spreading** p.84 - 85



*Quick to assemble with  
low shelf height*



1830mm High





from  
**£95.00**

## Z Rivet Racking

New 'Z' profile rivet system offers robust effective storage for any application

The 'Z' profile beam offers incredible strength with a shelf height of only 58mm.

The system requires only a hammer to build and just taps together. There are no nuts and bolts and the bays need no bracing therefore offering uninterrupted access on all four sides.

Bays are available in various heights up to 3660mm high, three widths to 1525mm and five shelf depths to 915mm.

### Z Rivet:

Bays with height to depth ratio above 4 : 1 will require fixing back to a wall or to the floor.



### For taller bays, simply add the following prices

Extra Height	Code	Price
bays 2135mm	ZRB/21/--/--/4	£4.20
bays 2440mm	ZRB/24/--/--/4	£8.60
bays 2745mm	ZRB/27/--/--/4	£13.00
bays 3050mm	ZRB/30/--/--/4	£18.00
bays 3660mm	ZRB/36/--/--/4	£25.80

### Bays c/w 5 shelves

Size (mm)	Code	Shelf Load (kg)	Bay Price	Shelf Code	Additional Shelf Price
1830 x 915 x 305	ZRB/18/09/03/5	300	£95.00	ZRS/09/03	£13.60
1830 x 915 x 457	ZRB/18/09/04/5	300	£107.35	ZRS/09/04	£16.05
1830 x 915 x 610	ZRB/18/09/06/5	300	£119.45	ZRS/09/06	£18.50
1830 x 915 x 762	ZRB/18/09/07/5	300	£155.50	ZRS/09/07	£23.15
1830 x 915 x 915	ZRB/18/09/09/5	300	£183.00	ZRS/09/09	£28.15
1830 x 1220 x 305	ZRB/18/12/03/5	250	£113.70	ZRS/12/03	£17.35
1830 x 1220 x 457	ZRB/18/12/04/5	250	£128.25	ZRS/12/04	£20.25
1830 x 1220 x 610	ZRB/18/12/06/5	250	£142.85	ZRS/12/06	£23.15
1830 x 1220 x 762	ZRB/18/12/07/5	250	£183.55	ZRS/12/07	£31.30
1830 x 1220 x 915	ZRB/18/12/09/5	250	£213.80	ZRS/12/09	£37.35
1830 x 1525 x 305	ZRB/18/15/03/5	200	£132.65	ZRS/15/03	£21.10
1830 x 1525 x 457	ZRB/18/15/04/5	200	£149.45	ZRS/15/04	£24.50
1830 x 1525 x 610	ZRB/18/15/06/5	200	£179.70	ZRS/15/06	£30.55
1830 x 1525 x 762	ZRB/18/15/07/5	200	£217.65	ZRS/15/07	£38.10
1830 x 1525 x 915	ZRB/18/15/09/5	200	£245.70	ZRS/15/09	£43.75

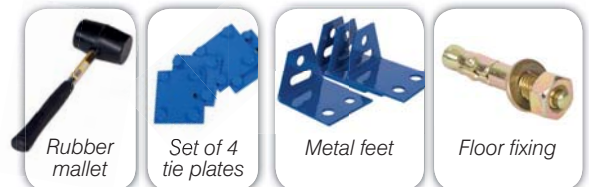

Item	Code	Price
<b>Tie Plate</b>		
Set of 4	RR8/SET4	£3.40
<b>Metal Feet</b>		
Set of 4	RR5/SET4	£3.80
<b>Floor Fixing</b>		
M8 x 50 floor fixing (each)	FFM8	£0.85
<b>Rubber Mallet</b>		
	MALLET	£3.30
<b>Safety Glove</b>		
	SGLOVE	£2.25



Bays with heavy duty euro containers

## Low Cost Shelving System

Our new J rivet system has unbeatable strength at an incredible price. It is also manufactured to the high quality you have come to expect from one of the UK's leading suppliers. The shallow J beam profile gives increased storage capacity whilst maintaining excellent strength. It is also compatible with the Z and Heavy rivet systems to increase its flexibility within any installation. The bays are available in six heights, two widths and three depths making space planning of any area simple and effective.

The system is simple to erect yet has all the strength you are likely to need. The bays just tap together with a rubber mallet so you can organise your storage in a fraction of the time it takes with more traditional systems. With the average time to assemble a bay being just 5 minutes, you will be amazed how easy it is to create large installations in no time. All bays are ready for immediate despatch and will be delivered in 5 working days.

### Key Features and Benefits:

- ★ **Increase storage density**  
A slim 30mm beam profile to maximise storage.
- ★ **Strong epoxy paint finish**  
Designed to give years of service and withstand heavy use.
- ★ **Great value for money**  
Now even more storage at minimum cost.
- ★ **Easy to build and reconfigure**  
Quickly gets your storage organised.
- ★ **No nuts, bolts or screws**  
Simple and quick to erect, with no fuss!
- ★ **Guaranteed delivery in 5 days**  
There when you want it – no fail.
- ★ **Will suit any application**  
Versatile and expandable and suits a wide range of industries.

## The affordable system that doesn't compromise on strength and quality

### Bays c/w 5 shelves

Size (mm)	Bay Code	Shelf Load (kg)	Bay Price	Shelf Code	Additional Shelf Price
1830 x 915 x 305	JRB/18/09/03/5	150	£74.65	JRS/09/03	£9.50
1830 x 915 x 457	JRB/18/09/04/5	150	£85.35	JRS/09/04	£11.65
1830 x 915 x 610	JRB/18/09/06/5	150	£96.35	JRS/09/06	£13.85
1830 x 1220 x 305	JRB/18/12/03/5	120	£87.30	JRS/12/03	£12.05
1830 x 1220 x 457	JRB/18/12/04/5	120	£100.20	JRS/12/04	£14.65
1830 x 1220 x 610	JRB/18/12/06/5	120	£113.70	JRS/12/06	£17.35

All bays come with uprights, plastic feet, perimeter beams, deck supports & 18mm chipboard decking

### For taller bays add the prices below

bays 2135mm	JRB/21/--/--/4	£4.20
bays 2440mm	JRB/24/--/--/4	£8.60
bays 2745mm	JRB/27/--/--/4	£13.00
bays 3050mm	JRB/30/--/--/4	£18.00
bays 3660mm	JRB/36/--/--/4	£25.80

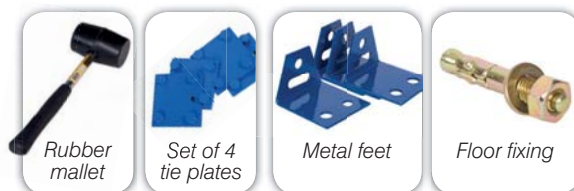

Item	Code	Price
<b>Tie Plate</b>		
Set of 4	RR8/SET4	£3.40
<b>Metal Feet</b>		
Set of 4	RR5/SET4	£3.80
<b>Floor Fixing</b>		
M8 x 50 floor fixing (each)	FFM8	£0.85
<b>Rubber Mallet</b>		
	MALLET	£3.30
<b>Safety Glove</b>		
	SGLOVE	£2.25



from  
**£74.<sup>65</sup>**

## Our lowest priced Rivet shelving system is back!



Simple tap in the beams

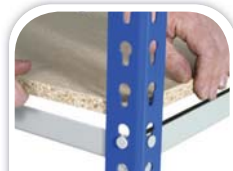

Strong chipboard decking



Complete with plastic feet

Have you seen...



Clicka Archive Shelving p.7



Have you seen...



Expo 3 galvanised shelving with dividers

p.32 - 33

## Z Rivet 'Pigeon Hole' Bays

If you need to create compartments to store awkward or valuable items then our Z Rivet Pigeon Hole system provides all the answers. We have designed a standard range of bays, which are all stocked and delivered within 5 days. The system uses the metal structure from our Z Rivet shelving system and with a combination of MDF shelves, dividers and cladding to create a unique and cost effective compartment system. As well as standard bays we can offer bespoke designs so please call to discuss your requirements.

### Key Features and Benefits:

- ★ New versatile compartment system
- ★ Create any number of compartments
- ★ Easy to build and re-configure
- ★ Cost effective storage solution
- ★ Tough and smooth MDF panels

from  
**£141.<sup>25</sup>**



**Bespoke designs available**

## Bin Fronts

Size (mm) H x W x D	Code	Price
915 x 60	ZRC/09/006/BF	£1.75
1220 x 60	ZRC/12/006/BF	£2.35
1525 x 60	ZRC/15/006/BF	£2.90

## Cladding Panels

1830mm high End Clads	Code	Price
305mm deep	ZRC/18/03/SC	£8.80
457mm deep	ZRC/18/04/SC	£13.20
610mm deep	ZRC/18/05/SC	£17.60

1830mm high Back Clads	Code	Price
915mm wide	ZRC/18/09/BC	£26.40
1220mm wide	ZRC/18/12/BC	£35.20
1525mm wide	ZRC/18/15/BC	£43.95

## Bays c/w 5 shelves, no bin fronts, end or back cladding

Size (mm) H x W x D	Code	Bay Price	Code	Shelf Price
<b>c/w 2 vertical dividers</b>				
1830 x 915 x 305	ZRCB/18/09/03/5	£141.25	ZRCS/09/03	£19.35
1830 x 915 x 457	ZRCB/18/09/04/5	£177.30	ZRCS/09/04	£24.80
1830 x 915 x 610	ZRCB/18/09/06/5	£204.10	ZRCS/09/06	£30.15
<b>c/w 3 vertical dividers</b>				
1830 x 1220 x 305	ZRCB/18/12/03/5	£178.40	ZRCS/12/03	£25.00
1830 x 1220 x 457	ZRCB/18/12/04/5	£225.85	ZRCS/12/04	£31.85
1830 x 1220 x 610	ZRCB/18/12/06/5	£273.15	ZRCS/12/06	£38.65
<b>c/w 4 vertical dividers</b>				
1830 x 1525 x 305	ZRCB/18/15/03/5	£220.00	ZRCS/15/03	£31.55
1830 x 1525 x 457	ZRCB/18/15/04/5	£281.15	ZRCS/15/04	£40.30
1830 x 1525 x 610	ZRCB/18/15/06/5	£339.40	ZRCS/15/06	£49.25

For taller bays, please contact the sales office

## Accessories

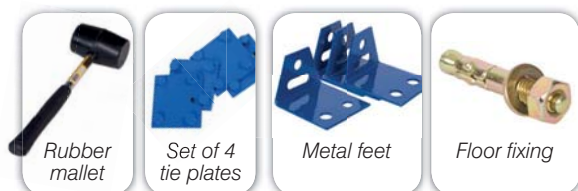

Rubber mallet

Set of 4 tie plates

Metal feet

Floor fixing

## Tie Plate

Set of 4	RR8/SET4	£3.40
----------	----------	-------

## Metal Feet

Set of 4	RR5/SET4	£3.80
----------	----------	-------

## Floor Fixing

M8 x 50 floor fixing (each)	FFM8	£0.85
-----------------------------	------	-------

## Rubber Mallet

MALLET	£3.30
--------	-------

## Safety Gloves

SGLOVE	£2.25
--------	-------

Have you seen...



Signs and labels

p.104

## Key Features and Benefits:



- ★ **All bays come complete with boxes**  
Exceptional value archive storage
- ★ **Easy to assemble and adjust**  
Quickly gets your storage organised
- ★ **No nuts or bolts**  
Simple and quick to erect, with no fuss!
- ★ **A wide range of sizes**  
Choose the option to suit your needs
- ★ **Single or double box deep**  
Versatile storage depending on your archiving needs
- ★ **Also available in Blue and Grey**

## Archive Storage:

Other sizes available - please phone for more details.

from  
**£161.<sup>55</sup>**



One box deep archive racking

from  
**£210.<sup>10</sup>**



Two box deep archive racking

### Bays 1525mm wide x 457mm one box deep or 915mm two box deep

Size (mm)	Shelf Levels	Code	Quantity of boxes	Total Price
Single box deep - 457mm deep				
1830 x 1525 x 457mm (1966mm)	3	RRAK15/24	24	£161.55
2440 x 1525 x 457mm (2614mm)	4	RRAK15/32	32	£215.00
3050 x 1525 x 457mm (3262mm)	5	RRAK15/40	40	£269.25
Double box deep - 915mm deep				
1830 x 1525 x 915mm (1966mm)	3	RRAK15/48	48	£274.95
2440 x 1525 x 915mm (2614mm)	4	RRAK15/64	64	£366.15
3050 x 1525 x 915mm (3262mm)	5	RRAK15/80	80	£458.15
Shelf capacity = 500kgs UDL				

### Bays 1830mm wide x 457mm one box deep or 915mm two box deep

Size (mm)	Shelf Levels	Code	Quantity of boxes	Total Price
Single box deep - 457mm deep				
1830 x 1830 x 457mm (1966mm)	3	RRAK18/30	30	£210.10
2440 x 1830 x 457mm (2614mm)	4	RRAK18/40	40	£279.70
3050 x 1830 x 457mm (3262mm)	5	RRAK18/50	50	£350.10
Double box deep - 915mm deep				
1830 x 1830 x 915mm (1966mm)	3	RRAK18/60	60	£333.55
2440 x 1830 x 915mm (2614mm)	4	RRAK18/80	80	£444.35
3050 x 1830 x 915mm (3262mm)	5	RRAK18/100	100	£546.55
Shelf capacity = 500kgs UDL				

## Need More Boxes?

- Large labelling area
- Holds 20kg
- Tote handles for easy carrying

### Archive Boxes - pack of 10

Size (mm)	Code	Price
430d x 350w x 270h	AK0020AB	£24.00



# Extra Tall Bays



Store 100 boxes per bay

### Archive Storage:

All bays come complete with archive boxes. Wide range of sizes are available.

### Have you seen...



Steps & Ladders p.82 - 83

# EXPO 4 - BOLTLESS SHELVING

## Key Features and Benefits:



- ★ Strong and versatile shelving
- ★ Fast and simple clip assembly
- ★ Huge choice of accessories
- ★ Open or clad bays
- ★ Starter and extension bay format
- ★ Shelf widths 700, 1000 and 1150mm
- ★ Shelf depths 300, 400, 500 and 600mm
- ★ Bay loads up to 2500kgs
- ★ Shelf pitch every 25mm
- ★ Easily dismantled and re-configured
- ★ Can be built as multi-tier or high bay
- ★ Huge stocks ready for immediate despatch
- ★ Epoxy powder paint



“ Expo 4 has been sold to thousands of satisfied customers for the past 23 years ”







### The Boltless Shelving System:

The unique friction steel clip and shelf design allows the system to be safely erected in minutes.

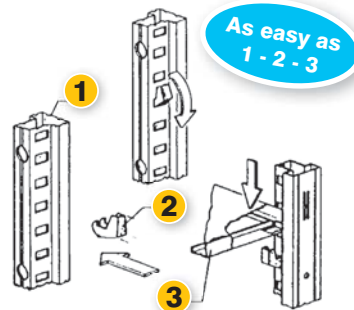

## Side Clad Shelving Bays



Easy Assembly

### Side Clad Shelving Bays:

All bays have 6 shelves, light grey side cladding and necessary fixings, bracing and plastic feet

### Key Features and Benefits:

- ★ Simple to fit
- ★ Safe and secure
- ★ No fixings needed
- ★ Slide cladding into place
- ★ Hook back panels onto bays



### Have you seen...

#### Back Cladding and Accessories

Simple to fit back cladding panels that simply hook in to the upright with no fixings required

p. 28 - 29



All bays c/w 6 shelves per bay, painted steel side cladding and necessary fixings, bracing & plastic feet

HxW (mm)	300mm deep				400mm deep				500mm deep				600mm deep			
	Str. Price	Ext. Price	Extra Shelf	Shelf Load (kg)	Str. Price	Ext. Price	Extra Shelf	Shelf Load (kg)	Str. Price	Ext. Price	Extra Shelf	Shelf Load (kg)	Str. Price	Ext. Price	Extra Shelf	Shelf Load (kg)
2000 x 700	£180.95	£120.33	£9.95	140	£219.35	£149.28	£13.20	130	£241.35	£166.43	£15.25	200	£280.55	£197.28	£19.00	180
CODE	E4S/ 200703/6/SC	E4E/ 200703/6/SC	E4/ 0703SH		E4S/ 200704/6/SC	E4E/ 200704/6/SC	E4/ 0704SH		E4S/ 200705/6/SC	E4E/ 200705/6/SC	E4/ 0705SH		E4S/ 200706/6/SC	E4E/ 200706/6/SC	E4/ 0706SH	
2000 x 1000	£197.75	£137.13	£12.75	110	£240.35	£170.28	£16.70	200	£263.85	£188.93	£19.00	180	£312.95	£229.68	£24.40	200
CODE	E4S/ 201003/6/SC	E4E/ 201003/6/SC	E4/ 1003SH		E4S/ 201004/6/SC	E4E/ 201004/6/SC	E4/ 1004SH		E4S/ 201005/6/SC	E4E/ 201005/6/SC	E4/ 1005SH		E4S/ 201006/6/SC	E4E/ 201006/6/SC	E4/ 1006SH	
2000 x 1150	£210.95	£150.33	£14.95	90	£261.05	£190.98	£20.15	180	£287.55	£212.63	£22.95	150	£343.55	£260.28	£29.50	150
CODE	E4S/ 201103/6/SC	E4E/ 201103/6/SC	E4/ 1103SH		E4S/ 201104/6/SC	E4E/ 201104/6/SC	E4/ 1104SH		E4S/ 201105/6/SC	E4E/ 201105/6/SC	E4/ 1105SH		E4S/ 201106/6/SC	E4E/ 201106/6/SC	E4/ 1106SH	
<b>Add the following prices to the bays above</b>																
2200	£10.60	£5.30			£15.20	£7.60			£19.40	£9.70			£30.00	£15.00		
CODE	E4S/ 22_03/6/SC	E4E/ 22_03/6/SC			E4S/ 22_04/6/SC	E4E/ 22_04/6/SC			E4S/ 22_05/6/SC	E4E/ 22_05/6/SC			E4S/ 22_06/6/SC	E4E/ 22_06/6/SC		
2500	£34.10	£17.05			£40.50	£20.25			£47.80	£23.90			£54.10	£27.05		
CODE	E4S/ 25_03/6/SC	E4E/ 25_03/6/SC			E4S/ 25_04/6/SC	E4E/ 25_04/6/SC			E4S/ 25_05/6/SC	E4E/ 25_05/6/SC			E4S/ 25_06/6/SC	E4E/ 25_06/6/SC		
3000	£57.30	£28.65			£61.00	£30.50			£64.10	£32.05			£67.80	£33.90		
CODE	E4S/ 30_03/6/SC	E4E/ 30_03/6/SC			E4S/ 30_04/6/SC	E4E/ 30_04/6/SC			E4S/ 30_05/6/SC	E4E/ 30_05/6/SC			E4S/ 30_06/6/SC	E4E/ 30_06/6/SC		



## Open Shelving Bays

With EXPO 4 it's as easy as 1-2-3

The unique friction steel clip and shelf design allows the system to be safely erected in minutes. It now boasts one of the largest selection of modular capacities and sizes, along with an unrivalled range of accessories all finished in a high quality epoxy powder coat paint. EXPO 4 offers designers and specifiers a solution to meeting any design brief, whether it's a few bays for the office, a multi tier or high bay project for the warehouse.

### Key Features and Benefits:

- ★ **Clip fit shelving**  
All steel shelf adjustable on steel shelf clips.
- ★ **Strong and simple to build**  
Build bays quickly and easily adjust shelves.
- ★ **Flexible storage systems**  
Easily adapts to your changing storage needs.
- ★ **Hard wearing paint finish**  
Offers a clean and bright epoxy powder paint finish.
- ★ **Huge range of accessories**  
Solve all your storage problems, now and in the future.

### Colours available:



### Open Shelving Bays:

All bays have 6 shelves and are supplied with fixings, bracing and plastic feet.

All bays come with 6 shelves per bay and all necessary fixings, bracing & plastic feet

HxW (mm)	300mm deep				400mm deep				500mm deep				600mm deep			
	Str. Price	Ext. Price	Extra Shelf	Shelf Load (kg)	Str. Price	Ext. Price	Extra Shelf	Shelf Load (kg)	Str. Price	Ext. Price	Extra Shelf	Shelf Load (kg)	Str. Price	Ext. Price	Extra Shelf	Shelf Load (kg)
2000 x 700	£141.55	£100.63	£9.95	140	£163.45	£121.33	£13.20	130	£177.75	£134.63	£15.25	200	£202.85	£158.43	£19.00	180
CODE	E4S/2007036	E4E/2007036	E4/0703SH		E4S/2007046	E4E/2007046	E4/0704SH		E4S/2007056	E4E/2007056	E4/0705SH		E4S/2007066	E4E/2007066	E4/0706SH	
2000 x 1000	£158.35	£117.43	£12.75	110	£184.45	£142.33	£16.70	200	£200.25	£157.13	£19.00	180	£235.25	£190.83	£24.40	200
CODE	E4S/2010036	E4E/2010036	E4/1003SH		E4S/2010046	E4E/2010046	E4/1004SH		E4S/2010056	E4E/2010056	E4/1005SH		E4S/2010066	E4E/2010066	E4/1006SH	
2000 x 1150	£171.55	£130.63	£14.95	90	£205.15	£163.03	£20.15	180	£223.95	£180.83	£22.95	150	£265.85	£221.43	£29.50	150
CODE	E4S/2011036	E4E/2011036	E4/1103SH		E4S/2011046	E4E/2011046	E4/1104SH		E4S/2011056	E4E/2011056	E4/1105SH		E4S/2011066	E4E/2011066	E4/1106SH	

Add the following prices to the bays above

2200	£4.00	£2.00			£4.00	£2.00			£4.00	£2.00			£4.00	£2.00		
CODE	E4S/22_036	E4E/22_036			E4S/22_046	E4E/22_046			E4S/22_056	E4E/22_056			E4S/22_066	E4E/22_066		
2500	£18.10	£9.05			£19.30	£9.65			£20.30	£10.15			£21.60	£10.80		
CODE	E4S/25_036	E4E/25_036			E4S/25_046	E4E/25_046			E4S/25_056	E4E/25_056			E4S/25_066	E4E/25_066		
3000	£36.00	£18.00			£38.40	£19.20			£40.40	£20.20			£43.00	£21.50		
CODE	E4S/30_036	E4E/30_036			E4S/30_046	E4E/30_046			E4S/30_056	E4E/30_056			E4S/30_066	E4E/30_066		

# EXPO 4 - BOLTLESS SHELVING



Ref	Description	Size (mm)	Quantity	Price
1	Freestanding divider	300 x 200	pack of 2	£25.20
	Freestanding divider	400 x 200	pack of 2	£28.15
	Freestanding divider	500 x 200	pack of 2	£31.70
	Freestanding divider	600 x 200	pack of 2	£35.40
2	Steel binning system (Complete with front and back panel and 4 sloping dividers)	1000 x 400	set	£65.90
		1000 x 600	set	£70.05
	Additional dividers	400	pack of 2	£15.60
		600	pack of 2	£17.70
3	Roll out drawer	1000 x 400	each	£220.90
		1000 x 600	each	£252.95
	Internal compartment system (Complete with 4 front to back dividers and 6 no. 155mm & 4 no. 223mm cross dividers)	1000 x 400	set	£74.30
		1000 x 600	set	£84.90
Additional cross dividers	223	each	£2.25	
	173	each	£2.05	
4	Plastic binning system	See page 96		
5	Garment rail	1000 x 400	set	£24.75
		1000 x 600	set	£26.40
6	Tyre rack	1000 x 400	set	£29.90
		1000 x 500	set	£30.80
7	Plinth	700 x 70	each	£18.15
		1000 x 70	each	£18.35
		1150 x 70	each	£19.75
8	Louvre back panel	1000 x 500	each	£47.80
9	Lateral filing frame	1000 x 400	each	£36.95
10	Roll out reference shelf	1000 x 400	each	£99.00
11	Roll out filing frame	1000 x 400	each	£99.00
12	Cupboard doors	2000 x 1000	each	£467.50

## Have you seen...



Utilise the back of the EXPO 4 shelving with our new Louvre Panels compatible with our Plastic bins.

p. 84 - 91

## Back Cladding

Light grey solid back cladding (hook in type)

Simple to fit back cladding panels that simply hook into the upright with no fixings required, they are suitable for both single and double sided runs. The panels are recessed so they finish flush with the back of the shelves whilst also providing the bracing for the bays. Each set comprises of panels 400mm or 500mm high to make the required height of the bay, with the first panel always starting 100mm from the floor.



Have you seen...



**Plastic Bins Pages p.84 - 99**

Width

Height (mm)	700mm		1000mm		1150mm	
	Code	Price	Code	Price	Code	Price
2000	EX14/2007/GY	£110.75	EX14/2010/GY	£122.05	EX14/2011/GY	£161.20
2200	EX14/2207GY	£123.05	EX14/2210GY	£135.45	EX14/2211GY	£182.60
2500	EX14/2507GY	£139.85	EX14/2510GY	£154.10	EX14/2511GY	£203.25
3000	EX14/3007GY	£168.95	EX14/3010GY	£186.20	EX14/3011GY	£245.25

All light grey finish - RAL7038

## Galvanised Welded Mesh Panels

(2" x 2" squares)

Strong and cost effective ways of cladding double sided runs only, for single side runs use the solid cladding above or speak to the sales office. The back panel sets are made from either two or three panels to make the height of the bay. The panels rest between the two bays and are joined and secured with cable ties.

### Mesh Panels:

A simple low cost way to clad bays of Expo 4 Shelving.

from **£28.90**



Mesh back panels



Width

Height (mm)	700mm		1000mm		1150mm	
	Code	Price	Code	Price	Code	Price
2000		to order	EX12/2010/GY	£28.90		to order
2200		to order	EX12/2210/GY	£31.50		to order
2500		to order	EX12/2510GY	£34.05		to order
3000		to order	EX12/3010GY	£43.35		to order

All galvanised finish

To order - usually 4 weeks

To order please see back cover



## Galvanised Boltless Shelving

Expo 3 uses the same upright from our Expo 4 shelving system, but has a unique shelf design which can have capacities up to 400kgs UDL. The design is based on a pair of shelf carriers and the combination of 100mm or 200mm panels to make up the required depth.



### Key Features and Benefits:

- ★ **Hard wearing galvanised finish**  
Tough and bright finish that will last the rigours of any environment
- ★ **Simple and easy to build**  
Build bays quickly to get your storage problems sorted fast
- ★ **No nuts, bolts or screws**  
Easy to assemble
- ★ **Will suit any application**  
Versatile and expandable and suits a wide range of industries

### Colours available:



All bays come with 6 shelves and all necessary fixings, bracing and plastic feet

Height x Depth (mm)	Code	Starter Price	Code	Extension Price	Code	Shelf Price	Shelf Load (kg)
<b>700mm Wide</b>							
2000 x 200	E3S/200702/6SD	£110.25	E3E/200702/6SD	£92.35	E3/0702SHSD	£8.30	90
2000 x 300	E3S/200703/6SD	£131.55	E3E/200703/6SD	£113.65	E3/0703SHSD	£11.85	135
2000 x 400	E3S/200704/6SD	£146.25	E3E/200704/6SD	£128.35	E3/0704SHSD	£14.30	180
2000 x 500	E3S/200705/6SD	£172.35	E3E/200705/6SD	£154.45	E3/0705SHSD	£18.65	225
2000 x 600	E3S/200706/6SD	£185.85	E3E/200706/6SD	£167.95	E3/0706SHSD	£20.90	270
2000 x 800	E3S/200708/6SD	£227.25	E3E/200708/6SD	£209.35	E3/0708SHSD	£27.80	300
<b>1000mm Wide</b>							
2000 x 200	E3S/201002/6SD	£122.55	E3E/201002/6SD	£104.65	E3/1002SHSD	£10.35	70
2000 x 300	E3S/201003/6SD	£152.55	E3E/201003/6SD	£134.65	E3/1003SHSD	£15.35	105
2000 x 400	E3S/201004/6SD	£170.85	E3E/201004/6SD	£152.95	E3/1004SHSD	£18.40	140
2000 x 500	E3S/201005/6SD	£205.65	E3E/201005/6SD	£187.75	E3/1005SHSD	£24.20	175
2000 x 600	E3S/201006/6SD	£222.75	E3E/201006/6SD	£204.85	E3/1006SHSD	£27.05	210
2000 x 800	E3S/201008/6SD	£276.45	E3E/201008/6SD	£258.55	E3/1008SHSD	£36.00	280

For taller bays add the following to the bay prices above

Height (mm)	Code	Starter Price	Code	Extension Price
2200mm	E3S/22___/6SD	£4.40	E3E/22___/6SD	£2.20
2500mm	E3S/25___/6SD	£11.00	E3E/25___/6SD	£5.50
3000mm	E3S/30___/6SD	£21.80	E3E/30___/6SD	£10.90

### Galvanised Boltless Shelving:

All bays come with 6 shelves and all necessary fixings, bracing and plastic feet.



## Key Features and Benefits:



- ★ **Hard wearing galvanised finish**  
Tough and bright finish that will last the rigours of any environment
- ★ **Wide choice of sizes**  
Flexibility to suit all your storage needs within one product
- ★ **Versatile and flexible system**  
Solve your business needs now and in the future
- ★ **Interchangeable with our Expo 4 system**  
Mix and match accessories and components with our Expo 4 systems
- ★ **Simple and easy to build**  
Build bays quickly to get your storage problems sorted fast



2 x 1300mm wide bays within a 2700mm wide pallet racking bay

All bays come with 6 shelves and all necessary fixings, bracing and plastic feet

Height x Depth (mm)	Code	Starter Price	Code	Extension Price	Code	Shelf Price	Shelf Load (kg)
<b>1150mm Wide</b>							
2000 x 200	E3S/201102/6SD	£128.55	E3E/201102/6SD	£110.65	E3/1102SHSD	£11.35	80
2000 x 300	E3S/201103/6SD	£162.75	E3E/201103/6SD	£144.85	E3/1103SHSD	£17.05	120
2000 x 400	E3S/201104/6SD	£182.85	E3E/201104/6SD	£164.95	E3/1104SHSD	£20.40	160
2000 x 500	E3S/201105/6SD	£221.85	E3E/201105/6SD	£203.95	E3/1105SHSD	£26.90	200
2000 x 600	E3S/201106/6SD	£240.75	E3E/201106/6SD	£222.85	E3/1106SHSD	£30.05	240
2000 x 800	E3S/201108/6SD	£300.45	E3E/201108/6SD	£282.55	E3/1108SHSD	£40.00	300
<b>1300mm Wide</b>							
2000 x 200	E3S/201302/6SD	£151.35	E3E/201302/6SD	£133.45	E3/1302SHSD	£15.15	70
2000 x 300	E3S/201303/6SD	£190.05	E3E/201303/6SD	£172.15	E3/1303SHSD	£21.60	105
2000 x 400	E3S/201304/6SD	£228.45	E3E/201304/6SD	£210.55	E3/1304SHSD	£28.00	140
2000 x 500	E3S/201305/6SD	£271.95	E3E/201305/6SD	£254.05	E3/1305SHSD	£35.25	175
2000 x 600	E3S/201306/6SD	£309.15	E3E/201306/6SD	£291.25	E3/1306SHSD	£41.45	210
2000 x 800	E3S/201308/6SD	£391.65	E3E/201308/6SD	£373.75	E3/1308SHSD	£55.20	280

For taller bays add the following to the bay prices above

Height (mm)	Code	Starter Price	Code	Extension Price
2200mm	E3S/22___/6SD	£4.40	E3E/22___/6SD	£2.20
2500mm	E3S/25___/6SD	£11.00	E3E/25___/6SD	£5.50
3000mm	E3S/30___/6SD	£21.80	E3E/30___/6SD	£10.90

### Galvanised Boltless Shelving:

All bays come with 6 shelves and all necessary fixings, bracing and plastic feet.

from  
**£219.<sup>50</sup>**



Slotted shelf

## Fixed Height Dividers

Expo 3 can now be fitted with a slotted shelf panel and fixed height dividers to create bays with compartments. The dividers are available either 300mm or 400mm high and will fit 300, 400, 500 or 600mm deep bays. The bay prices below are for open shelving and back cladding is on page 31. Other bay and compartment sizes are available to order, please contact the sales office.

### Key Features and Benefits:

- ★ New galvanised slotted shelf panel
- ★ Organise your warehouse or store
- ★ Create compartments within bays
- ★ Dividers 300 or 400mm high
- ★ Depths 300, 400, 500 or 600mm
- ★ Side and back cladding (extra cost)
- ★ Dividers can be spaced every 50mm

### Fixed Height Dividers:

All bays are open side and back except for necessary bracing. Number of shelves and dividers are indicated below.

Height x Depth (mm)	300mm deep		400mm deep		500mm deep		600mm deep	
<b>Bay Type A</b> 2000 x 1000mm 	<b>Code</b>	<b>Starter Price</b>	<b>Code</b>	<b>Starter Price</b>	<b>Code</b>	<b>Starter Price</b>	<b>Code</b>	<b>Starter Price</b>
	E3SDV2003	£252.50	E3SDV2004	£298.05	E3SDV2005	£355.35	E3SDV2006	£403.55
	<b>Code</b>	<b>Extension Price</b>	<b>Code</b>	<b>Extension Price</b>	<b>Code</b>	<b>Extension Price</b>	<b>Code</b>	<b>Extension Price</b>
	E3EDV2003	£219.50	E3EDV2004	£265.05	E3EDV2005	£322.35	E3EDV2006	£370.55
Each bay has 6 shelves incl top and bottom with 8 No. 400mm high and 2 No. 300mm high dividers								
<b>Bay Type B</b> 2200 x 1000mm 	<b>300mm deep</b>		<b>400mm deep</b>		<b>500mm deep</b>		<b>600mm deep</b>	
	<b>Code</b>	<b>Starter Price</b>	<b>Code</b>	<b>Starter Price</b>	<b>Code</b>	<b>Starter Price</b>	<b>Code</b>	<b>Starter Price</b>
	E3SDV2203	£290.75	E3SDV2204	£341.10	E3SDV2205	£411.45	E3SDV2206	£469.05
	<b>Code</b>	<b>Extension Price</b>	<b>Code</b>	<b>Extension Price</b>	<b>Code</b>	<b>Extension Price</b>	<b>Code</b>	<b>Extension Price</b>
E3EDV2203	£254.70	E3EDV2204	£305.05	E3EDV2205	£375.45	E3EDV2206	£432.95	
Each bay has 7 shelves incl top and bottom with 6 No. 400mm high and 6 No. 300mm high dividers								
<b>Bay Type C</b> 2500 x 1000mm 	<b>300mm deep</b>		<b>400mm deep</b>		<b>500mm deep</b>		<b>600mm deep</b>	
	<b>Code</b>	<b>Starter Price</b>	<b>Code</b>	<b>Starter Price</b>	<b>Code</b>	<b>Starter Price</b>	<b>Code</b>	<b>Starter Price</b>
	E3SDV2503	£300.10	E3SDV2504	£356.40	E3SDV2505	£421.65	E3SDV2506	£478.05
	<b>Code</b>	<b>Extension Price</b>	<b>Code</b>	<b>Extension Price</b>	<b>Code</b>	<b>Extension Price</b>	<b>Code</b>	<b>Extension Price</b>
E3EDV2503	£260.35	E3EDV2504	£316.70	E3EDV2505	£381.85	E3EDV2506	£438.30	
Each bay has 7 shelves incl top and bottom with 12 No. 400mm high								
<b>Bay Type D</b> 3000 x 1000mm 	<b>300mm deep</b>		<b>400mm deep</b>		<b>500mm deep</b>		<b>600mm deep</b>	
	<b>Code</b>	<b>Starter Price</b>	<b>Code</b>	<b>Starter Price</b>	<b>Code</b>	<b>Starter Price</b>	<b>Code</b>	<b>Starter Price</b>
	E3SDV3003	£345.75	E3SDV3004	£410.80	E3SDV3005	£485.65	E3SDV3006	£550.70
	<b>Code</b>	<b>Extension Price</b>	<b>Code</b>	<b>Extension Price</b>	<b>Code</b>	<b>Extension Price</b>	<b>Code</b>	<b>Extension Price</b>
E3EDV3003	£299.90	E3EDV3004	£365.00	E3EDV3005	£439.85	E3EDV3006	£504.90	
Each bay has 8 shelves incl top and bottom with 14 No. 400mm high								



Ref	Description	Size (mm)	Quantity	Price
1	Fixed Height Divider (d x h)	300 x 300	each	£6.50
	Fixed Height Divider (d x h)	400 x 300	each	£8.05
	Fixed Height Divider (d x h)	500 x 300	each	£10.00
	Fixed Height Divider (d x h)	600 x 300	each	£12.25
	Fixed Height Divider (d x h)	300 x 400	each	£6.80
	Fixed Height Divider (d x h)	400 x 400	each	£9.35
	Fixed Height Divider (d x h)	500 x 400	each	£10.50
	Fixed Height Divider (d x h)	600 x 400	each	£12.55
2	Bin front	1000 x 50	each	£7.65
		1000 x 90	each	£10.30
3	Steel binning system Complete with front and back panel and 4 sloping dividers	1000 x 400	set	£56.50
		1000 x 600	set	£59.95
	Additional Dividers	400	pack of 2	£13.30
		600	pack of 2	£15.05
4	Garment rail	1000 x 400	set	£24.70
		1000 x 600	set	£26.40
5	Tyre rack	1000 x 400	set	£29.90
		1000 x 500	set	£30.80



## Galvanised Solid Back Cladding (hook in type)

Simple to fit back cladding panels that simply hook into the upright with no fixings required, they are suitable for both single and double sided runs. The panels are recessed so they finish flush with the back of the shelves whilst also providing the bracing for the bays. Each set comprises of panels 400mm or 500mm high to make the required height of the bay, with the first panel always starting 100mm from the floor.

Height (mm)	700mm		1000mm		1150mm		1300mm	
	Code	Price	Code	Price	Code	Price	Code	Price
2000	EX14/2007/GV	£68.10	EX14/2010/GV	£84.60	EX14/2011/GV	£107.30	EX14/2013/GV	£112.95
2200	EX14/2207/GV	£75.70	EX14/2210/GV	£93.80	EX14/2211/GV	£121.45	EX14/2213/GV	£126.70
2500	EX14/2507/GV	£86.00	EX14/2510/GV	£106.85	EX14/2511/GV	£135.30	EX14/2513/GV	£142.55
3000	EX14/3007/GV	£103.90	EX14/3010/GV	£129.10	EX14/3011/GV	£163.30	EX14/3013/GV	£172.15

All galvanised finish

### Back Cladding:

Just add the prices to the bay prices on page 28 for back clad bays.

## Galvanised Welded Mesh Panels (2" x 2" squares)

Strong and cost effective ways of cladding double sided runs only, for single side runs use the solid cladding above or speak to our sales office. The back panel sets are made from either two or three panels to make the height of the bay. The panels rest between the two bays and are joined and secured with cable ties.

Height (mm)	700mm		1000mm		1150mm		1300mm	
	Code	Price	Code	Price	Code	Price	Code	Price
2000		to order	EX12/2010/GV	£28.80		to order		to order
2200		to order	EX12/2210/GV	£31.45		to order		to order
2500		to order	EX12/2510/GV	£34.05		to order		to order
3000		to order	EX12/3010/GV	£43.30		to order		to order

All galvanised finish. To order usually 4 weeks.

### Have you seen...



Idea 5 shelving p.38

from  
**£461.<sup>65</sup>**



## Euro Containers 148mm High

Bays c/w 10 shelves

Size H x W x D (mm)	Quantity and size of container	Bay Code	Starter Price	Bay Code	Extension Price
2000 x 1000 x 400	27No. - 400 x 300 x 148mm	EX3/EC01/ST	£461.65	EX3/EC01/EX	£428.65
2000 x 1300 x 600	27No. - 600 x 400 x 148mm	EX3/EC03/ST	£875.70	EX3/EC03/EX	£842.70

All bays have 9 levels of EURO CONTAINERS

### Expo 3 Storage:

Call us for other configurations.  
We are happy to discuss  
your requirements.



## Euro Containers 280mm High

Bays c/w 6 shelves

Size H x W x D (mm)	Quantity and size of container	Bay Code	Starter Price	Bay Code	Extension Price
2000 x 1000 x 400	15No. - 400 x 300 x 280mm	EX3/EC02/ST	£370.65	EX3/EC02/EX	£337.65
2000 x 1300 x 600	15No. - 600 x 400 x 280mm	EX3/EC04/ST	£623.80	EX3/EC04/EX	£590.80

All bays have 5 levels of EURO CONTAINERS

from  
**£422.<sup>25</sup>**



## Euro Containers Mixed Height

Bays c/w 8 shelves

Size H x W x D (mm)	Quantity and size of container	Bay Code	Starter Price	Bay Code	Extension Price
2000 x 1000 x 400	9No. - 400 x 300 x 280mm 12No. - 400 x 300 x 148mm	EX3/EC-MIX4/ST	£422.25	EX3/EC-MIX4/EX	£389.25
2000 x 1300 x 600	9No. - 600 x 400 x 280mm 12No. - 600 x 400 x 148mm	EX3/EC-MIX6/ST	£758.65	EX3/EC-MIX6/EX	£725.65

All bays have 7 levels of EURO CONTAINERS



## Distribution Containers

Bays c/w 6 shelves

Size H x W x D (mm)	Quantity and size of container	Bay Code	Starter Price	Bay Code	Extension Price
2000 x 1300 x 600	15No. - 600 x 400 x 320mm	EX3/DC01/ST	£685.70	EX3/DC01/EX	£652.70

All bays have 5 levels of DISTRIBUTION CONTAINERS



## Easy Storage Solutions

Here is a quick and easy way to get organised with our most competitive bays of Expo 3 shelving which come complete with our most popular accessories and storage containers. Choose from euro containers, distribution crates, adjustable binning systems as well as cost effective garment storage.

Have you seen... 



**New Euro Container Dollies** p.99



## Binning Racks

Bays c/w 6 shelves

Size H x W x D (mm)	Bay Code	Starter Price	Bay Code	Extension Price
2000 x 1000 x 400	EX3/BNG400/ST	£461.65	EX3/BNG400/EX	£428.75
2000 x 1000 x 600	EX3/BNG600/ST	£536.80	EX3/BNG600/EX	£503.80

All bays have 5 levels of binning and each level has 4 dividers, creating 3 compartments

## Garment Racks

Bays c/w 2 shelves

Size H x W x D (mm)	Bay Code	Starter Price	Bay Code	Extension Price
2000 x 1000 x 600	EX3/GAR/ST	£175.90	EX3/GAR/EX	£142.90

Each bay comes with two shelves and two levels of garment storage

from  
**£122.<sup>65</sup>**

## Delta Edge Shelving

Our New stylish delta edge shelving is ideal for both office and warehouse environments

The delta profile offers excellent strength but has slim clean lines making it ideal for the office.

The system is an all steel construction with shelves adjustable every 25mm, with a shelf capacity of 80kgs. The 350mm deep shelf has been designed to take standard 330mm lateral files underneath adding extra versatility.

The system is available in standard sizes shown below but also other sizes and accessories are available to order, please contact the sales office.



### Key Features and Benefits: ★

- ★ New stylish shelving system
- ★ Ideal for office and warehouse
- ★ All steel construction
- ★ Smoke white finish (RAL9002)
- ★ True delta edge profile
- ★ Shelves adjust every 25mm



### Bays c/w 6 shelves, open backs (except for back bracing)

Height x Width x Depth (mm)	Bay Code	Starter Price	Bay Code	Extension Price	Shelf Code	Shelf Price
1880 x 750 x 350	DBS/18/07/35/6	£164.90	DBE/18/07/35/6	£122.65	DES/0735SH	£13.40
1880 x 750 x 450	DBS/18/07/45/6	£192.40	DBE/18/07/45/6	£143.00	DES/0745SH	£15.60
1880 x 1000 x 350	DBS/18/10/35/6	£183.80	DBE/18/10/35/6	£140.95	DES/1035SH	£16.35
1880 x 1000 x 450	DBS/18/10/45/6	£215.20	DBE/18/10/45/6	£165.20	DES/1045SH	£19.20
2230 x 750 x 350	DBS/22/07/35/6	£176.50	DBE/22/07/35/6	£128.45	DES/0735SH	£13.40
2230 x 750 x 450	DBS/22/07/45/6	£205.50	DBE/22/07/45/6	£149.55	DES/0745SH	£15.60
2230 x 1000 x 350	DBS/22/10/35/6	£195.40	DBE/22/10/35/6	£146.75	DES/1035SH	£16.35
2230 x 1000 x 450	DBS/22/10/45/6	£228.30	DBE/22/10/45/6	£171.75	DES/1045SH	£19.20



350mm deep shelf (will hold lateral files underneath)



Freestanding adjustable dividers (150mm high)



Fixed height compartment dividers to order - 4 weeks

### Back cladding sets

Size (mm)	Code	Price
1880 x 750	DE5/1807/WH	£49.40
1880 x 1000	DE5/1810/WH	£66.45
2230 x 750	DE5/2207/WH	£57.95
2230 x 1000	DE5/2210/WH	£74.35

### Freestanding dividers 200mm high

Size (mm)	Code	Price
350 x 150	DE6/035/020	£8.35
450 x 150	DE6/045/020	£8.90



**Perfect for:**  
**Retail**  
**Office**  
**Schools**  
**Archive**  
**Stores**



## Idea 5 Shelving

Our latest bolt free all steel shelving system, offering a cost effective way to provide hard wearing solutions to any storage problem. The hard wearing pre-galvanised steel enables the system to be used in demanding environments whilst giving the system a modern and bright look and feel. With only two components – upright and shelf, the IDEA 5 design has eliminated the need for nuts, bolts or clips meaning bays can be erected quickly and without fuss. The unique connection between the upright and shelf provides incredible stability whilst offering uninterrupted access from all sides of the bay. IDEA 5 has a wide range of sizes so you can easily space plan awkward spaces to get the maximum storage capacity.

### Key Features and Benefits: ★

- ★ **No clips or bracing**
- ★ **Unique interlocking uprights**
- ★ **Assemble in minutes**
- ★ **Tough hardwearing finish**
- ★ **Wide range of sizes**

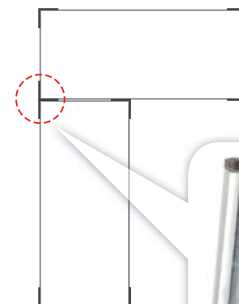
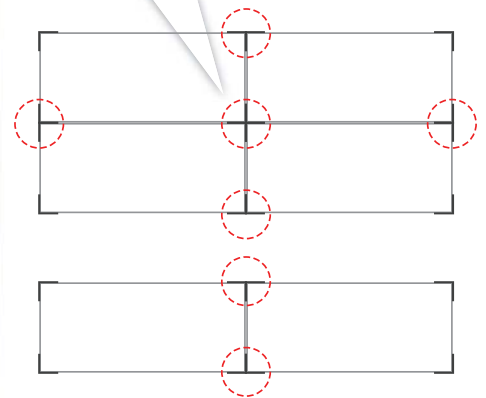



**All bays have 5 shelves**

Height x Width x Depth (mm)	Colour	Code	Price	Shelf code	Shelf load (kgs)	Shelf price
1800 x 800 x 300	Galvanised	IDB/180830/5/GV	£58.15	ID2/8003/GV	100	£6.75
1800 x 800 x 400R	Galvanised	IDB/180840R/5/GV	£70.40	ID2/8004R/GV	140	£9.20
1800 x 800 x 500R	Galvanised	IDB/180850R/5/GV	£83.40	ID2/8005R/GV	140	£11.80
1800 x 800 x 600RR	Galvanised	IDB/180860R/5/GV	£92.40	ID2/8006RR/GV	150	£13.60
1800 x 1000 x 300	Galvanised	IDB/181030/5/GV	£65.40	ID2/1003R/GV	90	£8.20
1800 x 1000 x 400R	Galvanised	IDB/181040R/5/GV	£80.90	ID2/1004R/GV	130	£11.30
1800 x 1000 x 500R	Galvanised	IDB/181050R/5/GV	£96.90	ID2/1005R/GV	130	£14.50
1800 x 1000 x 600RR	Galvanised	IDB/181060R/5/GV	£110.40	ID2/1006RR/GV	140	£17.20

R = single under shelf reinforcing rib

RR = double under shelf reinforcing rib

**for taller bays add the following prices (codes - amend using guidance below)**

bays 2200mm high	Galvanised	IDB/22___/5/GV	£5.40
bays 2600mm high	Galvanised	IDB/26___/5/GV	£11.60



## Chrome Wire

Our chrome wire shelving system offers simple to build and stylish storage solutions

The system is ideal for home and office as well as retail display due to the open wire construction which offers excellent light distribution onto the products displayed.

The shelving is also suited for kitchens storing dry food and crockery etc, whilst the excellent ventilation through the system makes it perfect for server racks and computer workstations as well as laundry and linen stores.

The nickel chrome finish offers a bright, clean and modern feel to the shelving, but should only be used in dry areas and should not come into contact with moisture.

### Key Features and Benefits:

- ★ Strong and stylish shelving
- ★ Nickel chrome finish
- ★ Excellent light and air circulation
- ★ No tools, simply slots together
- ★ Shelf loads up to 300kgs UDL
- ★ Shelf pitch every 25mm
- ★ Use castors for mobile units
- ★ No interfering uprights in corners
- ★ 25mm diameter post

### Features:

Uprights have extra marks every 125mm for easier positioning of shelves.

Every post comes with an adjustable leveller.



All bays have 4 shelves, plastic collars and adjustable feet

Size (mm)	Code	Starter bay price	Code	Extension bay price	Code	Shelf price	Load - Kgs
1590 x 610 x 305	CWS/15/06/0305/4	£81.40	CWE/15/06/0305/4	£72.90	CW2/06/0305	£12.30	300
1590 x 762 x 305	CWS/15/07/0305/4	£90.00	CWE/15/07/0305/4	£81.50	CW2/07/0305	£14.45	300
1590 x 762 x 355	CWS/15/07/03/4	£97.80	CWE/15/07/03/4	£89.30	CW2/07/03	£16.40	300
1590 x 915 x 355	CWS/15/09/03/4	£108.80	CWE/15/09/03/4	£100.30	CW2/09/03	£19.15	300
1590 x 1220 x 355	CWS/15/12/03/4	£130.40	CWE/15/12/03/4	£121.90	CW2/12/03	£24.55	240
1590 x 1525 x 355	CWS/15/15/03/4	£152.20	CWE/15/15/03/4	£143.70	CW2/15/03	£30.00	190
1590 x 460 x 460	CWS/15/04/04/4	£84.40	CWE/15/04/04/4	£75.90	CW2/04/04	£13.05	270
1590 x 762 x 460	CWS/15/07/04/4	£108.80	CWE/15/07/04/4	£100.30	CW2/07/04	£19.15	270
1590 x 915 x 460	CWS/15/09/04/4	£121.80	CWE/15/09/04/4	£113.30	CW2/09/04	£22.40	270
1590 x 1220 x 460	CWS/15/12/04/4	£147.20	CWE/15/12/04/4	£138.70	CW2/12/04	£28.75	220
1590 x 1525 x 460R*	CWS/15/15/04/4	£180.00	CWE/15/15/04/4	£171.50	CW2/15/04/R	£36.95	200
1590 x 610 x 610	CWS/15/06/06/4	£114.80	CWE/15/06/06/4	£106.30	CW2/06/06	£20.65	240
1590 x 762 x 610	CWS/15/07/06/4	£130.40	CWE/15/07/06/4	£121.90	CW2/07/06	£24.55	240
1590 x 915 x 610	CWS/15/09/06/4	£147.20	CWE/15/09/06/4	£138.70	CW2/09/06	£28.75	240
1590 x 1220 x 610	CWS/15/12/06/4	£180.20	CWE/15/12/06/4	£171.70	CW2/12/06	£37.00	190
1590 x 1525 x 610R*	CWS/15/15/06/4	£220.80	CWE/15/15/06/4	£212.30	CW2/15/06/R	£47.15	180

\*R = reinforced with one central truss

### Taller bays add

Bays 1895mm high	CWS/18/--/--/4	£5.60	CWE/18/--/--/4	£2.80
Bays 2200mm high	CWS/22/--/--/4	£11.40	CWE/22/--/--/4	£5.70







**Chrome Wire Shelving:**  
Simple to build, stylish storage solutions.

### 3 Tier Trolley

Size (mm)	Code	Price
970 x 915 x 460	CWSKIT2	£123.55
970 x 915 x 610	CWSKIT3	£143.85

The kit comes with three shelves and four uprights 854mm, one trolley handle, two braked and two un-braked castors. (each castors capacity 70kgs)

### Wine Rack

Size (mm)	Code	Price
1590 x 915 x 355	CWSKIT4	£146.10
1590 x 1220 x 355	CWSKIT5	£173.95

The kit comes with three wines shelves, three standard shelves and four uprights 1590mm. (915mm wide - 9 bottles and 1220mm wide - 13 bottles)

### Garment Rack

Size (mm)	Code	Price
1895 x 915 x 460	CWSKIT6	£105.35
1895 x 1220 x 460	CWSKIT7	£121.20
1895 x 1525 x 460	CWSKIT8	£160.20

The kit comes with three standard shelves, four uprights 1895mm, and one garment rail



# CHROME WIRE SHELVING

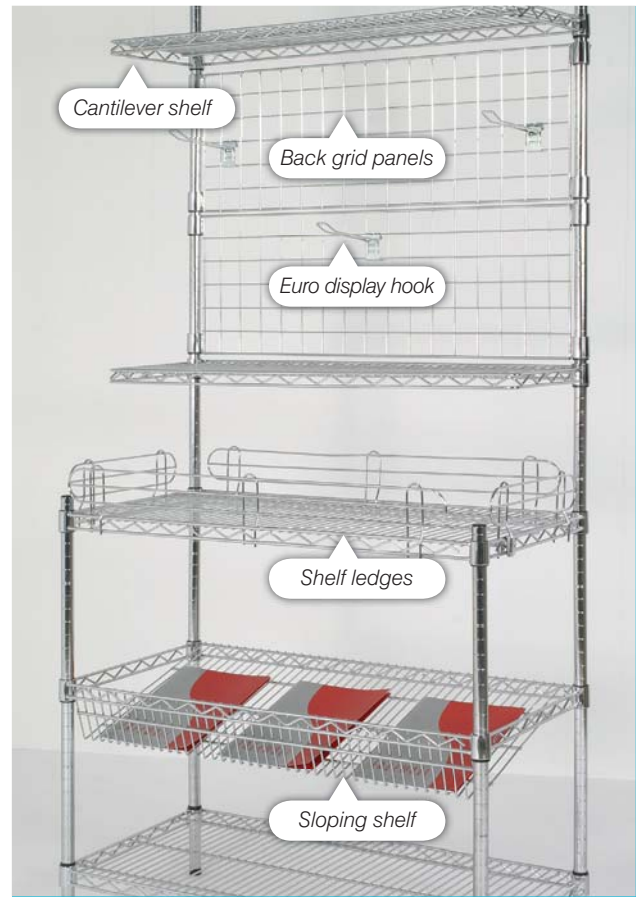

Uprights



Shelf Collars



Post Clamp



Shelf

## Chrome Wire Shelving:

It's easy to build your ideal storage solution.

from  
**£18.<sup>85</sup>**

### Shelves

Size (mm)	Code	Capacity - Kgs	Price
610 x 305	CW2/06/0305	300	£12.30
762 x 305	CW2/07/0305	300	£14.45
762 x 355	CW2/07/03	300	£16.40
915 x 355	CW2/09/03	300	£19.15
1220 x 355	CW2/12/03	240	£24.55
1525 x 355	CW2/15/03	190	£30.00
460 X 460	CW2/04/04	270	£13.05
762 x 460	CW2/07/04	270	£19.15
915 x 460	CW2/09/04	270	£22.40
1220 x 460	CW2/12/04	220	£28.75
1525 X 460 R	CW2/15/04/R	200	£36.95
610 X 610	CW2/06/06	240	£20.65
762 x 610	CW2/07/06	240	£24.55
915 x 610	CW2/09/06	240	£28.75
1220 x 610	CW2/12/06	190	£37.00
1525 X 610 R	CW2/15/06/R	180	£47.15

All shelves include plastic collars

### Uprights

Size (mm)	Code	Price
372	CW1/0372	£2.30
854	CW1/0854	£4.55
1388	CW1/1388	£7.10
1590	CW1/1590	£8.05
1895	CW1/1895	£9.45
2200	CW1/2200	£10.90

### Fittings

Description	Code	Price
S clip	CW3	£0.95
Post clamp	CW11	£1.50
Plastic collars (pairs)	CW18/BPC	£0.25
Metal collar (pairs)	CW18/MPC	£1.90
Upright plastic top cap	CW22/TC	£0.15
Metal foot leveller M10	CW22/MFM10	£0.50
Plastic foot leveller M10	CW22/PFM10	£0.50



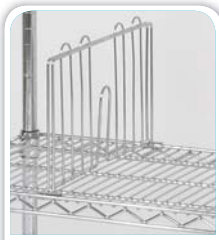

**A** Shelf divider



**B** Shelf ledges

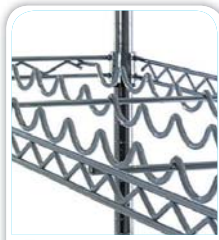

**C** Wine shelf



**D** Garment rail



**E** Utility rail

Ref	Description	Size (mm)	Code	Price
<b>A</b>	Shelf dividers 200mm high	355	CW7/3	£3.70
		460	CW7/4	£4.40
		610	CW7/6	£5.35
<b>B</b>	Shelf ledges 110mm high	355	CW6/03	£2.95
		460	CW6/04	£3.30
		610	CW6/06	£3.85
		915	CW6/09	£5.40
		1220	CW6/12	£6.50
		1525	CW6/15	£7.95
<b>C</b>	Wine shelf (includes plastic collars)	915 x 355 (9 bottles)	CW2/WS0903	£23.00
		1220 x 355 (13 bottles)	CW2/WS1203	£29.50
<b>D</b>	Garment rail	915	CW5/09	£8.60
		1220	CW5/12	£10.00
		1525	CW5/15	£11.45
<b>E</b>	Utility rail	355	CW8/03	£1.75
		460	CW8/04	£2.05
		610	CW8/06	£2.50
		915	CW8/09	£3.40
		1220	CW8/12	£4.25
		1525	CW8/15	£5.10
<b>F</b>	Euro display hook	75	CW9/75	£2.10
		150	CW9/150	£3.10
		225	CW9/225	£4.15
<b>G</b>	Ticket edging	100 x 43	CW12/CL	£0.55
		840 x 43	CW12/CL840	£2.55
		1140 x 43	CW12/CL1140	£3.45
		1440 x 43	CW12/CL1440	£4.30
<b>H</b>	Castors (100mm diameter)	Standard braked	CW4B	£9.65
		Standard un-braked	CW4	£7.60
		Anti-static braked	CWAS4B	£27.90
		Anti-static non braked	CWAS4	£21.60
<b>I</b>	Trolley handle	460	CW10/460	£5.50
		610	CW10/610	£6.50
<b>J</b>	Back grid panels	915 x 305	CW13/03/09	£13.55
		1220 x 305	CW13/03/12	£17.45
<b>K</b>	Cantilever shelf	915 x 305	CW15/09/03	£23.00
		1220 x 305	CW15/12/03	£29.45
<b>L</b>	Sloping shelf	915 x 355	CW16/09/35	£23.10
		915 x 460	CW16/09/46	£26.30
		1220 x 355	CW16/12/35	£31.95
		1220 x 460	CW16/12/46	£37.35

All accessories come with the necessary plastic collars



**F** Euro display hook



**G** Ticket edging



**H** Castor  
(with brake)



**I** Trolley handle



**J** Back grid panels



**K** Cantilever shelf



**L** Sloping shelf

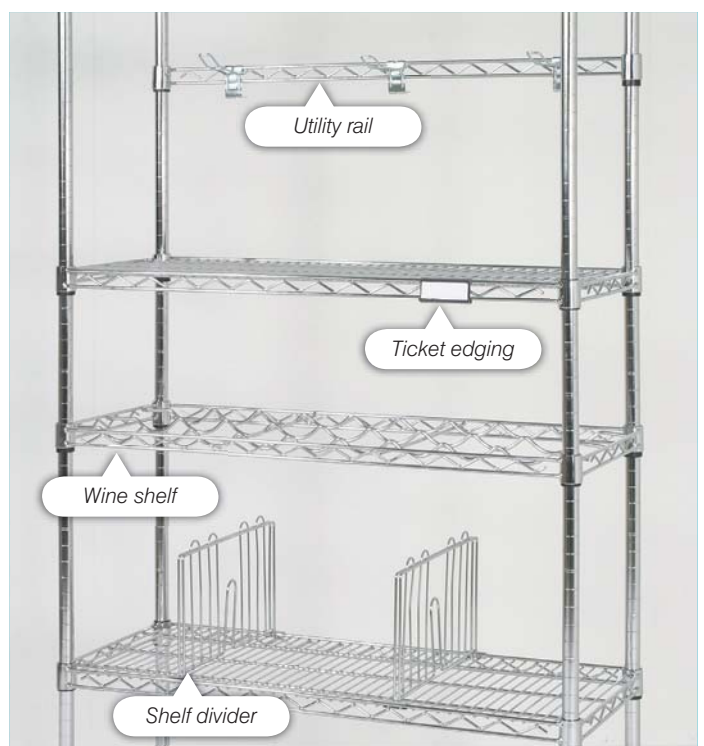

## Basket Shelves

Chrome wire baskets are ideal for keeping stuff neat and tidy within the bay of shelving. The baskets are 100mm deep with either 915 or 1220mm wide x 460mm deep. Each shelf comes complete with 4 sets of plastic collars.



### Basket shelves - 100mm deep

Description	Size (mm)	Code	Price
Chrome Wire Basket	915 x 460	CW22/09/04	£26.15
Chrome Wire Basket	1220 x 460	CW22/12/04	£33.55



## Acrylic Shelf Covers

Acrylic shelf covers that simply and securely fit on top of our standard chrome wire shelves, enabling smaller or more unstable items to sit on the wire shelves. The sheets come 3mm thick and are clear so there is no loss of light passing through the shelves.

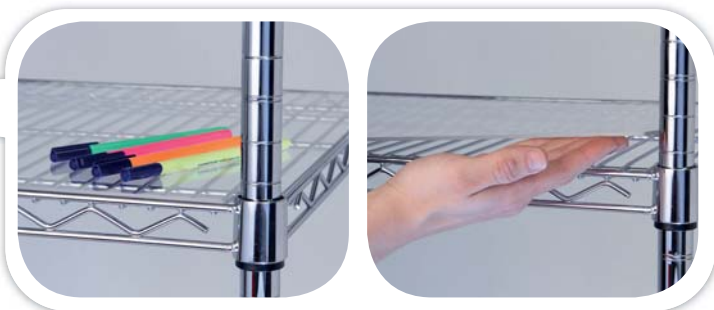

### Acrylic Shelf Covers

Description	Size (mm)	Code	Price
Acrylic shelf covers	915 x 355	CW21/09/03	£19.45
3mm thick	915 x 460	CW21/09/04	£25.15
Clear	915 x 610	CW21/09/06	£32.95

## Fan Shelf

With the addition of the Fan Shelf you can create additional display areas on the outside of two right angled runs of shelving. As well as corner display units the fan shelf can soften the end of runs near corridors or entrances. Available in 460 and 610mm deep and comes complete with 3 sets of plastic collars.



### Fan Shelves

Description	Size (mm)	Code	Price
Fan Shelf	460 x 460	CW20/04	£15.70
	610 x 610	CW20/06	£23.50



## Half Moon Shelf

Available in two sizes 460 and 610mm, these half-moon shelves fit onto the ends of a standard wire shelving bay. Ideal in the retail environment for creating extra display space as well as highlighting more prominent merchandise to the consumer. Come complete with two sets of plastic collars.



### Half Moon Shelves

Description	Size (mm)	Code	Price
Half Moon	460	CW19/04	£26.15
	610	CW19/06	£33.55

## Galvanised Racking System



Have you seen...



Distribution Containers p.98



### Garment Rails

Length (mm)	Finish	Load UDL (kg)	Code	Price (pair)
1600mm	Galv	100	MS/GAR16	£73.80
1800mm	Galv	80	MS/GAR18	£80.65
2000mm	Galv	65	MS/GAR20	£84.75

for frame prices see opposite on page 47



Two Tier



Heavy Duty



Tyre Racks

## Galvanised Racking System



### Key Features and Benefits:

- ★ Heavy duty and secure
- ★ Easy to build and reconfigure
- ★ Beams adjust every 25mm
- ★ Guaranteed delivery in 5 days
- ★ Available in blue or galvanised upright
- ★ Galvanised beams and decking panels



### Galvanised Shelving:

Super strong and galvanised for long life.

### Frames

All kd assembly Height (mm)	Depth 400mm	Depth 600mm	Depth 800mm	Depth 1000mm	Depth 1200mm
1950mm	£46.50	£48.45	£50.10	£52.75	£55.15
2550mm	£57.65	£61.60	£65.75	£69.75	£73.70
3000mm	£66.55	£71.40	£72.80	£76.90	£80.25

Frames come in kit form for self assembly

### C50 Profile Beam Levels - including all galvanised decking

Width (mm)	Load (kg)	Depth 400mm galv.	Depth 600mm galv.	Depth 800mm galv.	Depth 1000mm galv.	Depth 1200mm galv.
1000	400	£31.00	£37.55	£45.80	£53.75	£59.60
1200	340	£36.85	£44.65	£54.50	£63.90	£70.95
1600	250	£48.55	£58.80	£71.85	£84.35	£93.70

Includes pair of beams, decking, safety pins and beam ties

### C70 Profile Beam Levels - including all galvanised decking

Width (mm)	Load (kg)	Depth 400mm galv.	Depth 600mm galv.	Depth 800mm galv.	Depth 1000mm galv.	Depth 1200mm galv.
1800	660	£75.55	£87.00	£101.65	£115.70	£126.25
2000	600	£83.65	£96.30	£112.60	£128.15	£139.80
2400	480	£99.95	£115.05	£134.55	£153.20	£158.40

Includes pair of beams, decking, safety pins and beam ties

### Have you seen...



**Small Parts Galvanised Shelving p.30**

# LONGSPAN - HEAVY DUTY

New 2745 wide bays  
fit two standard pallets underneath

from  
**£30.<sup>80</sup>**



Have you seen...



**New Steel Decking Panel Price  
p.50**



## Frames - all KD assembly frames

Height (mm)	Depth 457mm		Depth 610mm		Depth 762mm		Depth 915mm		Depth 1220mm	
	Code	Price	Code	Price	Code	Price	Code	Price	Code	Price
1830	LSF/18/04/BE	£35.55	LSF/18/06/BE	£36.85	LSF/18/07/BE	£37.95	LSF/18/09/BE	£39.80	LSF/18/12/BE	£42.70
2135	LSF/21/04/BE	£41.70	LSF/21/06/BE	£43.40	LSF/21/07/BE	£44.90	LSF/21/09/BE	£47.25	LSF/21/12/BE	£50.90
2440	LSF/24/04/BE	£48.75	LSF/24/06/BE	£50.70	LSF/24/07/BE	£52.35	LSF/24/09/BE	£55.15	LSF/24/12/BE	£59.45
3050	LSF/30/04/BE	£61.80	LSF/30/06/BE	£64.45	LSF/30/07/BE	£66.65	LSF/30/09/BE	£70.40	LSF/30/12/BE	£76.10
3660	LSF/36/04/BE	£68.40	LSF/36/06/BE	£71.35	LSF/36/07/BE	£73.70	LSF/36/09/BE	£77.90	LSF/36/12/BE	£84.25

## Beam levels - including chipboard decking, deck supports and safety pins

Width (mm)	Load UDL (kg)	Depth 457mm		Depth 610mm		Depth 762mm		Depth 915mm		Depth 1220mm	
		Code	Price	Code	Price	Code	Price	Code	Price	Code	Price
1220	1200	LSB/12/04/OR	£30.80	LSB/12/06/OR	£39.10	LSB/12/07/OR	£45.10	LSB/12/09/OR	£49.15	LSB/12/12/OR	£57.55
1525	1000	LSB/15/04/OR	£36.20	LSB/15/06/OR	£48.85	LSB/15/07/OR	£54.25	LSB/15/09/OR	£57.85	LSB/15/12/OR	£67.55
1830	800	LSB/18/04/OR	£47.15	LSB/18/06/OR	£57.20	LSB/18/07/OR	£62.15	LSB/18/09/OR	£67.40	LSB/18/12/OR	£78.25
2135	700	LSB/21/04/OR	£55.20	LSB/21/06/OR	£66.60	LSB/21/07/OR	£72.80	LSB/21/09/OR	£79.30	LSB/21/12/OR	£92.00
2440	600	LSB/24/04/OR	£61.90	LSB/24/06/OR	£74.85	LSB/24/07/OR	£81.95	LSB/24/09/OR	£89.05	LSB/24/12/OR	£102.10
2745	440	LSB/27/04/OR	£69.70	LSB/27/06/OR	£82.25	LSB/27/07/OR	£88.90	LSB/27/09/OR	£95.60	LSB/27/12/OR	£108.75

Deck supports = none on 457mm deep, 1220 to 1830mm wide have 3, 2135 to 2440mm have 4, 2745mm wide have 5 per level





**Key Features and Benefits:**



- ★ **Heavy Duty Racking system**  
Store all your heavy and bulk items with ease.
- ★ **Adaptable storage solutions**  
Simple to add to, as your storage needs grow.
- ★ **Strong “Z” profile beam design**  
Unique beam design that offers capacities up to 1200kgs.
- ★ **Heavy duty shelf levels**  
Shelf levels includes deck supports to match beam capacities.
- ★ **Guaranteed delivery in 5 days**  
Get your stores organised quickly with no hassle.

## Long Span Heavy Duty Racking

**Economical storage whilst providing unrivalled strength and rigidity**

The design offers an upright width of 47mm with a central tapered slot which offers a strong friction connection whilst being easier to install the beam levels. The beams are formed as an 87mm “Z” profile section with a 3 fingered claw that can be adjusted on a pitch of 50.8mm (2 inch). The beams are then fitted with deck supports on all bays 610mm and deeper. The tie also locates into the beam eliminating any beam rotation. Each level is then fitted with high density chipboard panels.



from  
**£127.95**



Heavy duty deck supports



Secure location of beams

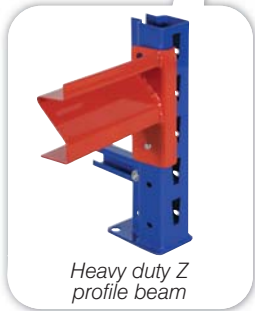

Heavy duty Z profile beam



## Garment Storage

Cost effective and flexible garment hanging system, which fits our heavy duty long span frames

The rails come in pairs and are available in lengths 1220mm, 1525mm and 1830mm. The rail is a 30mm diameter tube and the rails can be adjusted on a pitch of 50.8mm on the frame.



**Please note:**

For frame prices see page 48.

**Garment rails - levels only**

Length (mm)	Finish	Load UDL	Code	Price (Pair)
1220	orange	100kgs	LS/GAR12	£16.15
1525	orange	90kgs	LS/GAR15	£19.35
1830	orange	80kgs	LS/GAR18	£22.55

Beams come complete with safety pins



## Automotive Storage Solutions

We offer a range of solutions for automotive storage from tyre racks, vertical panel storage to hanging exhaust systems.





## Steel Decking Panels

Galvanised steel panels available in 3 depths and all beam lengths

These panels are made from 1.2mm galvanised steel and simply drop into the step down beam. The hard wearing galvanised finish offers a clean, smooth finish enabling goods to be easily placed on the shelves and any spills wiped away. Other depths are available to order within 4 weeks.

levels from **£64.<sup>55</sup>**

**Please note:**

For frame prices see page 48.

**Beam levels - including steelpanels, one beam tie and safety pins**

Width (mm)	Load UDL (kg)	Depth 610mm		Depth 915mm		Depth 1220mm	
		Code	Price	Code	Price	Code	Price
1220	720	LSS/12/06/OR	£64.55	LSS/12/09/OR	£73.45	LSS/12/12/OR	£84.05
1525	900	LSS/15/06/OR	£79.15	LSS/15/09/OR	£89.95	LSS/15/12/OR	£102.90
1830	800	LSS/18/06/OR	£94.40	LSS/18/09/OR	£107.10	LSS/18/12/OR	£122.45
2135	700	LSS/21/06/OR	£108.20	LSS/21/09/OR	£122.80	LSS/21/12/OR	£140.55
2440	600	LSS/24/06/OR	£123.65	LSS/24/09/OR	£140.20	LSS/24/12/OR	£160.25
2745	440	LSS/27/06/OR	£134.25	LSS/27/09/OR	£152.75	LSS/27/12/OR	£175.20



# PALLET RACKING



Frame fixing kit

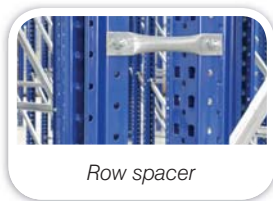

Row spacer

## Frames

Size (mm)	Upright profile (mm)	Capacity (Kgs)	Price
2400 x 900	80	6000	£89.35
3000 x 900	80	6000	£110.70
3900 x 900	80	9000	£171.65
5100 x 900	80	9000	£218.10
6000 x 900	80	9000	£255.00

For frames 1050mm add 5%  
Frames come supplied in kit form.

Frame loading has been calculated on beams installed at 1500mm centres  
in a 6m high frame and a run of 6 bays all 2700mm wide.

## Beams

Size (mm)	Beam profile (mm)	Load (kg) pair	Price (pair)
1350	80/1.5	3300	£49.90
2225	80/1.5	2400	£75.70
2700	100/1.5	2600	£98.10
2700	120/1.5	2800	£106.35
3300	120/1.5	2900	£130.15
3300	140/1.5	3300	£139.90

Five finger claw design, beam loadings have been calculated on a deflection of 1/200.

## Accessories

	Price
Row spacer 200mm	£12.10
Row spacer 250mm	£12.65
L shape upright protector	£23.25
U shape upright protector	£38.10
Packing plate 1.5mm	£1.25
Packing plate 2.0mm	£1.40
Floor fixing M12 x 90mm	£1.25

# Pallet Racking

Our pallet racking system is held in stock in the most popular sizes, we can also supply factory orders within 4 weeks.

The system compares with the best on the market and it now conforms to SEMA and FEM regulations and we are offering from stock a 6 ton and 9 ton capacity frame. We have a broad range of capacities, sizes and options which are all available from the factory.

Please contact us for further information.

**Please note:**

Frames come supplied in kit form.



Frames from **£89.<sup>35</sup>**



**Have you seen...**



**Expo 3 Galvanised Shelving Bays** p.30 - 35

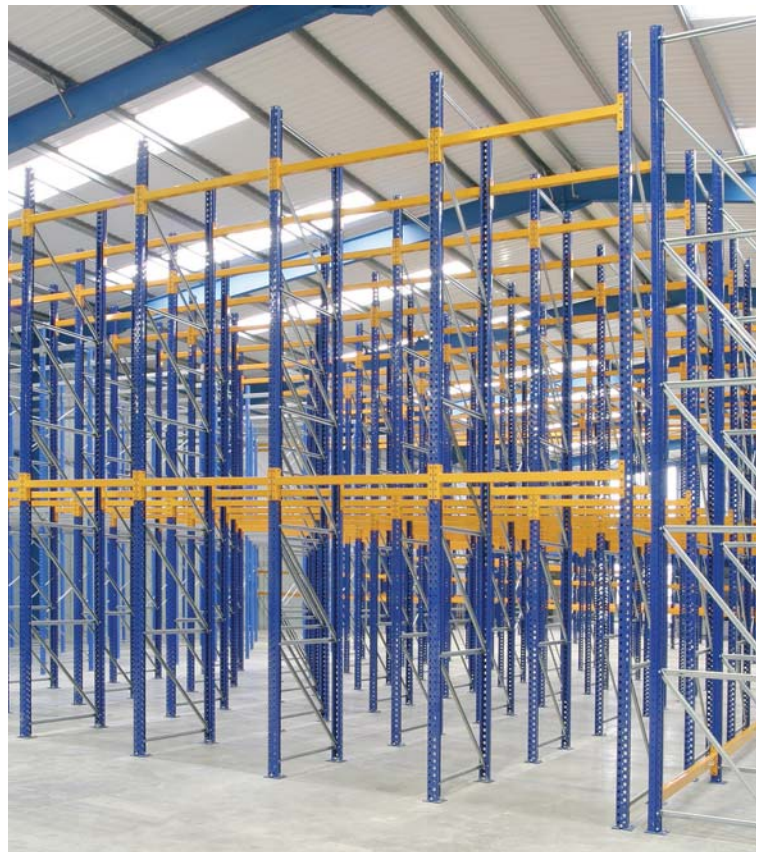

# CANTILEVER RACK

## Key Features and Benefits:

- ★ **Incredible value for money**  
Now even more storage at minimum cost.
- ★ **Easy to build and reconfigure**  
Quickly gets your storage organised.
- ★ **Guaranteed delivery in 5 days**  
There when you want it – no fail.
- ★ **Frames capacities up to 1750kgs**
- ★ **Arms carry loads up to 185kgs**
- ★ **Strong epoxy finish in blue RAL5010**
- ★ **Colours co-ordinate with our shelving systems**
- ★ **Arms adjust every 70mm**



### Cantilever Rack:

We also offer 1500mm wide bays, please contact the sales office for more information.



from  
**£281.<sup>45</sup>**



Front detail of base

## Cantilever Rack

### Strong and easy to build system

Our cantilever system is based on modular bays and fittings to provide cost effective storage of long and awkward items. The frames are available in 3 heights and two depths in both single and double sided configurations.

Each bay comes complete with 3 arms per frame and you can add or deduct the number of levels required. The arms can be fitted with end stops (at an additional cost shown) to secure any loose products from falling off.

The frames are spaced 1000mm apart with bolted on X brace, so you can easily work out your run using the starter and extension bay. Prices below.



Adjustable arm pin



End stop for arms

### Starter and Extension Bays

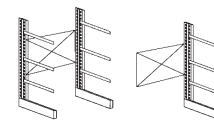

Single sided

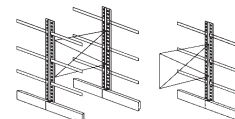

Double sided



End stop for base

All bays come with 3 arms + base per frame and all necessary, bracing and fixing plates

Height x Depth (mm)	Single sided 1000mm wide				Double sided 1000mm wide			
	Starter Price	Extension Price	Extra Arms	Arm Capacity (kg)	Starter Price	Extension Price	Extra Arms	Arm Capacity (kg)
2000 x 600	£515.35	£281.45	£21.35	185	£719.50	£383.55	£21.35	185
CODE	CRS/2006/S3	CRE/2006/S3	CR/ARM06		CRS/2006/D3	CRE/2006/D3	CR/ARM06	
2000 x 800	£561.10	£304.30	£24.65	135	£809.55	£428.80	£24.65	135
CODE	CRS/2008/S3	CRE/2008/S3	CR/ARM08		CRS/2008/D3	CRE/2008/D3	CR/ARM08	
<b>For taller frames add the following prices to the bays above</b>								
2500	£59.85	£30.00			£59.85	£30.00		
CODE	CRS/25_/S3	CRE/25_/S3			CRS/25_/D3	CRE/25_/D3		
3000	£119.75	£59.95			£119.75	£59.95		
CODE	CRS/30_/S3	CRE/30_/S3			CRS/30_/D3	CRE/30_/D3		
End stop for arm	£6.35							
End stop for base	£10.55							

For 1500mm wide bays, please add £25.00 per bay

# VERTICAL RACK



**Vertical Rack:**  
The intermediate hoop dividers can be adjusted to any position along the beam and tighten in position.

Have you seen...



**Cantilever Systems, ideal if you need to store items horizontally. p.54 - 55**

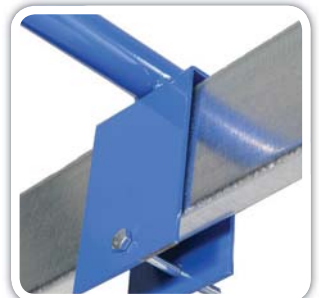



# Great value storage for long and awkward items

from  
**£390.10**



## Vertical Rack

Offers a cost effective way of storing all those long and awkward items

Our new vertical racking is derived from our Heavy Duty Midispan system.

The system comes as a starter and extension bay format meaning long runs are more cost effective.

The bays come with 3 adjustable dividers, all necessary frames and base plates, two front beams, one back beam and base rail. Other size racks available to order, please contact your sales office.

### Key Features and Benefits:

- ★ **Great value for money**  
Now even more storage at minimum cost.
- ★ **Store all your long awkward items**  
Quickly gets your storage organised.
- ★ **Simple to build and reconfigure**
- ★ **Fully adjustable hoop dividers**
- ★ **Starter and extension bay system**
- ★ **Can be secured to the floor**



**Vertical Rack:**  
Suitable for items 3000mm in length.



All bays come complete with 3 dividers - see additional information

Height x Width x Depth (mm)	Starter		Extension	
	Code	Price	Code	Price
2550 x 1200 x 750	VRS/2512/3	£578.50	VRE/2512/3	£390.10
2550 x 1800 x 750	VRS/2518/3	£617.80	VRE/2518/3	£460.75

Extra adjustable hoop dividers

Height x Depth (mm)	Code	Price
1000 x 400	DIV1004	£58.70

**Starter bay**

**Complete with:**  
1 x LH fixed divider  
1 x RH fixed divider  
1 x Adjustable divider

**Extension bay**

**Complete with:**  
3 x Adjustable divider

# RIVET WORKBENCH



from  
**£86.70**

Workbench with  
Light Grey MFC

### 3 Worktops Available



Chipboard  
(Included)

MDF  
(+20%)

Light Grey MFC  
(+30%)

## Rivet Workbench

A cost effective answer to solve your busy packing and assembly areas. Strong and simple to build these workbenches come in a wide range of sizes that will suit most applications. We now offer 3 styles of 18mm thick tops - chipboard, MDF or light grey MFC, with the MFC tops being edged with a hard wearing 1mm PVC edging.

### Workbench

Size (mm) H x W x D	Code	Price
915 x 915 x 762	RRWB/09/09/07	£86.70
915 x 915 x 915	RRWB/09/09/09	£96.00
915 x 1220 x 762	RRWB/09/12/07	£102.50
915 x 1220 x 915	RRWB/09/12/09	£113.60
915 x 1525 x 762	RRWB/09/15/07	£113.70
915 x 1525 x 915	RRWB/09/15/09	£125.70
915 x 1830 x 762	RRWB/09/18/07	£137.20
915 x 1830 x 915	RRWB/09/18/09	£151.50
915 x 2135 x 762	RRWB/09/21/07	£158.80
915 x 2135 x 915	RRWB/09/21/09	£167.60
915 x 2440 x 762	RRWB/09/24/07	£179.20
915 x 2440 x 915	RRWB/09/24/09	£189.30

200kgs shelf capacity  
add 20% for MDF work tops  
add 30% for light grey mfc tops and 10 working days for delivery



Workbench with  
Chipboard

## Rivet Workstation

Simple to build and incredibly strong these picking and assembly workbenches come with a strong worktop, 915mm high and two storage shelves above (305mm deep). Also available in 3 styles of 18mm thick tops - chipboard, MDF or light grey MFC, with the MFC tops being edged with a hard wearing 1mm PVC edging.

### Key Features and Benefits



- ★ **Easy to build and adjust**  
Quickly gets your storage organised
- ★ **Other sizes available**  
Choose the option to suit your needs
- ★ **Available in blue/grey and blue orange**



Workstation with T-Bar



Workstation with full undershelf

from  
**£127.<sup>50</sup>**



Workstation with half undershelf

### 3 Worktops Available



Chipboard  
(Included)

MDF  
(+20%)

Light Grey MFC  
(+30%)

### Workstation

Size (mm) H x W x D	T-Bar		Half Undershelf		Full Undershelf	
	Code	Price	Code	Price	Code	Price
915 x 915 x 915	RRWS/18/09/09/03T	£127.50	RRWS/18/09/09/03HS	£142.95	RRWS/18/09/09/03FS	£149.30
915 x 1220 x 915	RRWS/18/12/09/03T	£141.85	RRWS/18/12/09/03HS	£161.20	RRWS/18/12/09/03FS	£169.30
915 x 1830 x 915	RRWS/18/18/09/03T	£186.75	RRWS/18/18/09/03HS	£218.80	RRWS/18/18/09/03FS	£227.90
915 x 2440 x 915	RRWS/18/24/09/03T	£225.35	RRWS/18/24/09/03HS	£265.80	RRWS/18/24/09/03FS	£278.15

200kgs shelf capacity  
add 20% for MDF work tops  
add 30% for light grey mfc tops and 10 working days for delivery

To order please see back cover



## Heavy Duty Workbench

A range of heavy duty workbenches with a massive 800kg UDL capacity, ideal for heavy duty applications. The Heavy steel frames support a 40mm multi-ply beech worktop that will stand the rigours of the harshest use. The units can be fitted with a variety of suspended drawer and door cabinets, that can be fitted anywhere along the length of the bench for greater flexibility. The frames are blue RAL5012 and drawers and doors RAL7035.

### Key Features and Benefits

- ★ Simple to build and configure
- ★ Heavy duty – 800kgs Loading
- ★ 40mm Beech multi-ply tops
- ★ A wide range of drawer cabinets
- ★ 750mm deep and 840mm high



Heavy Duty Drawer Workbench					Suspended Drawer Cabinets						
Description	Size (mm) L x D x H	Code	Load kgs	Price	Description	Size (mm) L x D x H	Code	Configuration	Drawer/ Door Size	Load kgs	Price
Workbench 1200 x 750	1200 x 750 x 840	WBH/120/075	800	£279.95	Drawer Cabinet Model 1	475 x 550 x 208	WBUC/M1	1 drawer	150	40	£90.15
Workbench 1500 x 750	1500 x 750 x 840	WBH/150/075	700	£339.05	Drawer Cabinet Model 2	475 x 550 x 358	WBUC/M2	2 drawers	100+200	40	£246.50
Workbench 1750 x 750	1750 x 750 x 840	WBH/175/075	600	£404.50	Drawer Cabinet Model 4	475 x 550 x 458	WBUC/M4	2 drawers	100+300	40	£269.60
Workbench 2000 x 750	2000 x 750 x 840	WBH/200/075	500	£442.05	Drawer Cabinet Model 7	475 x 550 x 458	WBUC/M7	1 door + 1 drawer	300+100	40	£206.85
Worktops come un-lacquered					Drawer Cabinet Model 8	475 x 550 x 608	WBUC/M8	3 drawers	100+150+300	40	£376.75
					Drawer Cabinet Model 9	475 x 550 x 608	WBUC/M9	4 drawers	2x100+150+200	40	£424.20

300mm high drawers can hold A4 suspension files

Workbench Size	Capacity
L x D x H (mm)	Kgs
1500 x 800 x 870	600
2000 x 800 x 870	400

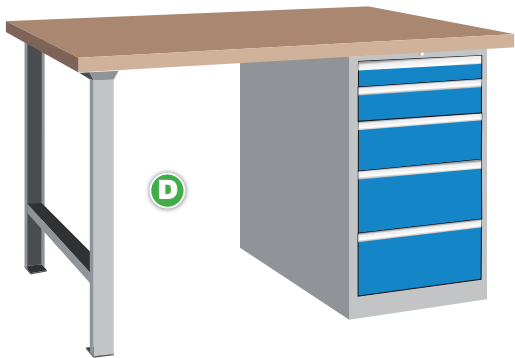
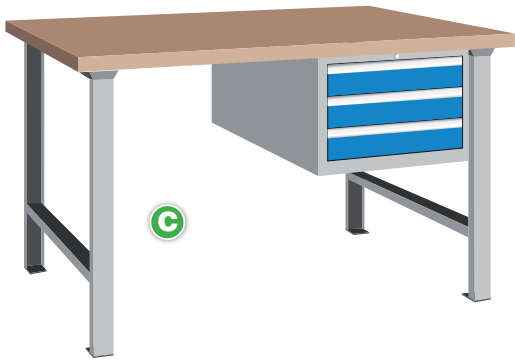
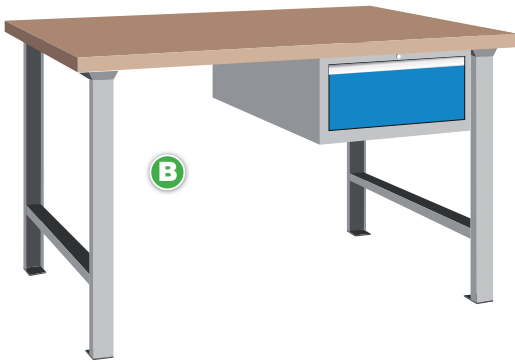

### Key Features and Benefits

- ★ Simple to build and configure
- ★ Strong and sturdy steel frames
- ★ 35mm Multi-ply worktops
- ★ Wide range of drawer cabinets
- ★ Drawers can hold 70kgs load
- ★ Drawers can be sub-divided (17mm)



## Multi Workbench

The Multi Workbench system has been designed to perform in all production and mechanical workshop environments. They meet the demands of a modern workplace through a solid engineered design, modular and flexible configurations, with the possibility to add a huge range of accessories including drawer cabinets, tool panels, lighting and electrical points. Speak to the sales office for further details.

Multi Workbench	1500mm wide				2000mm wide	
	Description	Workbench Size L x D x H (mm)	Load kgs	Code	Price	Code
Workbench (no drawer unit) type A	1500 x 800 x 870	600	W15P/08/A	£312.80	W20P/08/A	£369.60
Workbench with drawer type B	1500 x 800 x 870	600	W15P/08/B	£662.00	W20P/08/B	£719.70
Workbench with drawer type C	1500 x 800 x 870	600	W15P/08/C	£734.90	W20P/08/C	£789.55
Workbench with drawer type D	1500 x 800 x 870	600	W15P/08/D	£999.05	W20P/08/D	£1,053.70

Worktops come un-lacquered. Legs and Cabinet housing - light grey (RAL7038), Drawers - Blue (RAL 5015)  
Come in kit form for assembly on site

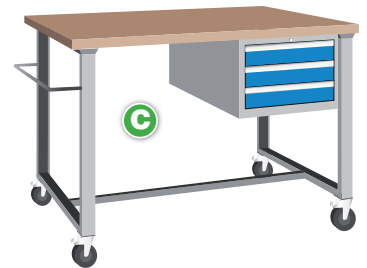
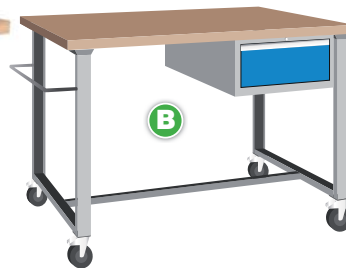

## Mobile Workbench

Using the Multi workbench frame, this strong and sturdy Mobile Workbench provides a flexible solution to your workplace needs. Each bench comes with 2 fixed castors and 2 swivel castors (braked) along with a handle at one end to make manoeuvring safe and controlled.

Mobile Bench:	1500mm wide		2000mm wide	
	Description	Code	Price	Code
Mobile Bench (no drawer unit) type A	W15M/08/A	£390.00	W20M/08/A	£442.10
Mobile Bench with drawer type B	W15M/08/B	£751.45	W20M/08/B	£803.55
Mobile Bench with drawer type C	W15M/08/C	£814.30	W20M/08/C	£866.40

Worktops come un-lacquered. Legs and Cabinet housing - light grey (RAL7038), Drawers - Blue (RAL 5015)  
Come in kit form for assembly on site



### Key Features and Benefits

- ★ Heavy duty all steel construction
- ★ Quick and simple to build
- ★ Flexible configuration of cabinets
- ★ 850mm to top of the work surface
- ★ 30mm retaining edge to three sides

## All Steel Workbench

All Steel Heavy duty workbench with a hardwearing steel top that has a 30mm perimeter lip to keep all the items safely on the work surface. The bench and suspended drawer cabinet are all finished in a tough resilient light grey finish (RAL7038). The unit has been designed to be incredibly strong and sturdy and meet the demands of the toughest workplace. The flexibility is further enhanced with the ability to fit a variety of storage units in multiple locations underneath the bench, see guidance layouts below.

### Suspended Unit Positions for 1500mm wide bench

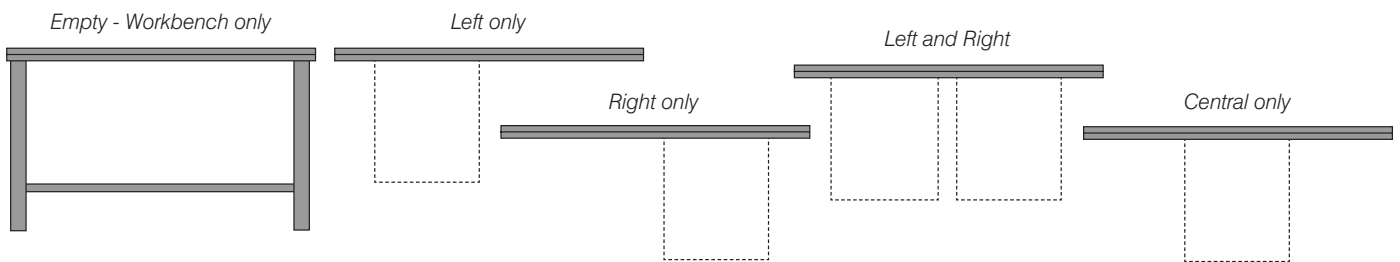

### Suspended Unit Positions for 2000mm wide bench

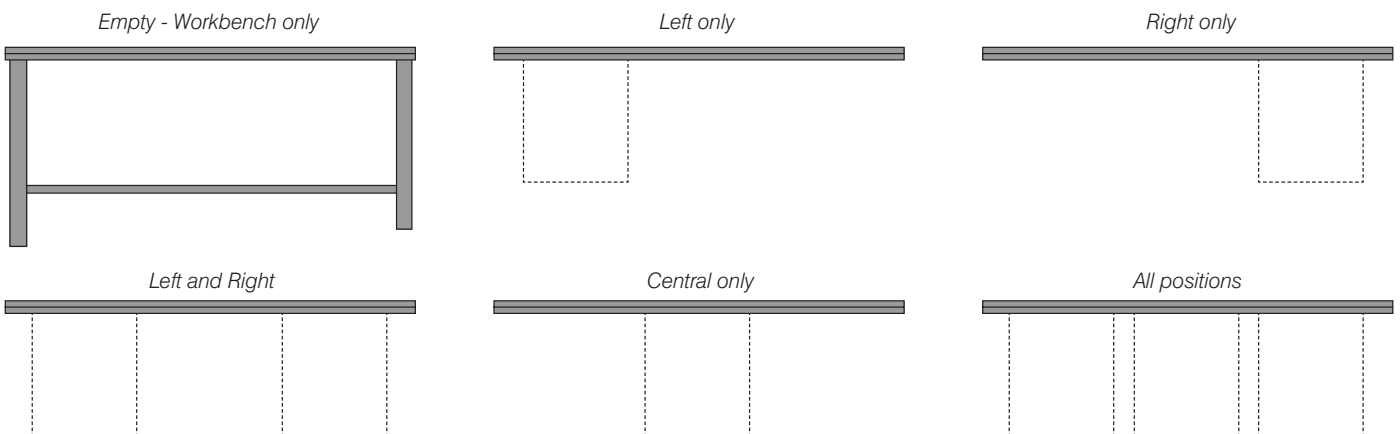

#### Configure your Workbench!

Illustrations below show how you can position any of the 3 available storage units.

#### Heavy All steel Workbench

Size (L x D x H)	Code	Price
1500 x 700 x 850	WSS/15/07	£379.60
2000 x 700 x 850	WSS/20/07	£440.35

#### Suspended Drawer Cabinets

Description	Size (L x D x H)	Code	Price
Single drawer unit - type A	505 x 580 x 210	WSS/UCA	£108.15
Three drawer unit - type B	505 x 580 x 600	WSS/UCB	£297.60
Drawer & door unit - type C	505 x 580 x 600	WSS/UCC	£236.55

Legs and drawers units - light grey (RAL7038). Come in kit form for assembly on site



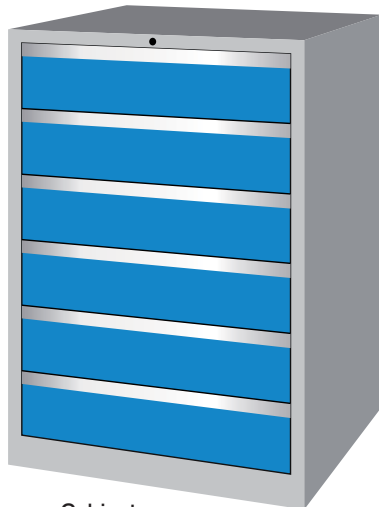

## Steel Drawer Cabinets

Our range of heavy duty drawers are made with a tough welded steel construction and come finished in a hardwearing epoxy powder finish. The housings are in a grey RAL7038 and the drawers are blue RAL5015. All units have a central locking mechanism with each drawer having the security of being fitted with a anti-tilt mechanism. The drawers offer 100% extension and a capacity of 70kgs with dividers adjustable every 17mm for maximum flexibility.

**6 Drawer Cabinet**  
Drawers = 6 x 150

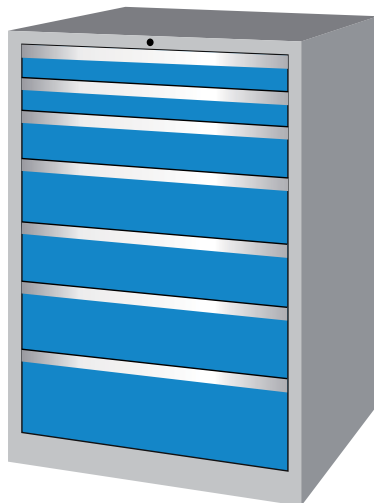

**7 Drawer Cabinet**  
Drawers = 2 x 75, 1 x 100, x 3 x 150, 1 x 200

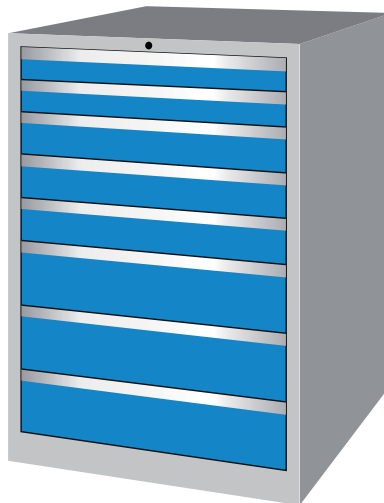

**8 Drawer Cabinet**  
Drawers = 2 x 75, 3 x 100, 3 x 150

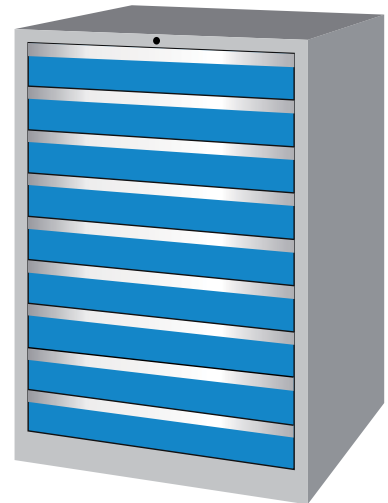

**9 Drawer Cabinet**  
Drawers = 9 x 100

### Drawer Cabinets

Description	Size (mm) L x D x H	Code	Price
6 Drawer Cabinet - RX Drawer unit 62P	717 x 640 x 1000	WRX10062P	£847.25
7 Drawer Cabinet - RX Drawer unit 71P	717 x 640 x 1000	WRX10071P	£907.95
8 Drawer Cabinet - RX Drawer unit 82P	717 x 640 x 1000	WRX10082P	£999.05
9 Drawer Cabinet - RX Drawer unit 92P	717 x 640 x 1000	WRX10092P	£1,059.80

### 9 Compartment Internal Divider System

Description	Code	Price
Drawer Height - 75mm	WRXSD7507	£18.25
Drawer Height - 100mm	WRXSD10008	£23.70
Drawer Height - 150mm	WRXSD15007	£24.60
Drawer Height - 200mm	WRXSD20008	£34.05

2 front to back dividers and 6 cross dividers

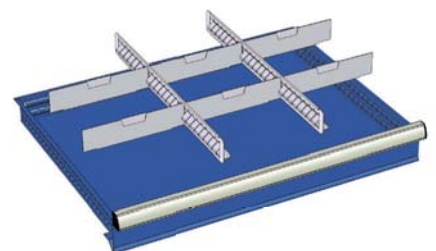

## The “Complete” Packing Bench

The ultimate packing station that comes complete with everything you need to process, pack and despatch orders. Offering a safe and ergonomic workstation, which comes complete with lower bubble wrap dispenser, upper paper roll dispenser, with tear bar. There are two upper shelves, one for general storage and one with dividers for storing boxes and envelopes. The work top is 22mm thick light grey mfc and comes with a cutter bar complete with safety blade and a lower storage drawer.

### The Complete Packing Bench

Size (mm) H x L x D	Code	Price
1750 x 1800 x 800	CPB/17/18/08	£980.00



Tear bar allows paper to be easily torn to size



Suspended drawer for added storage



Cutting bar has integral blade attachment

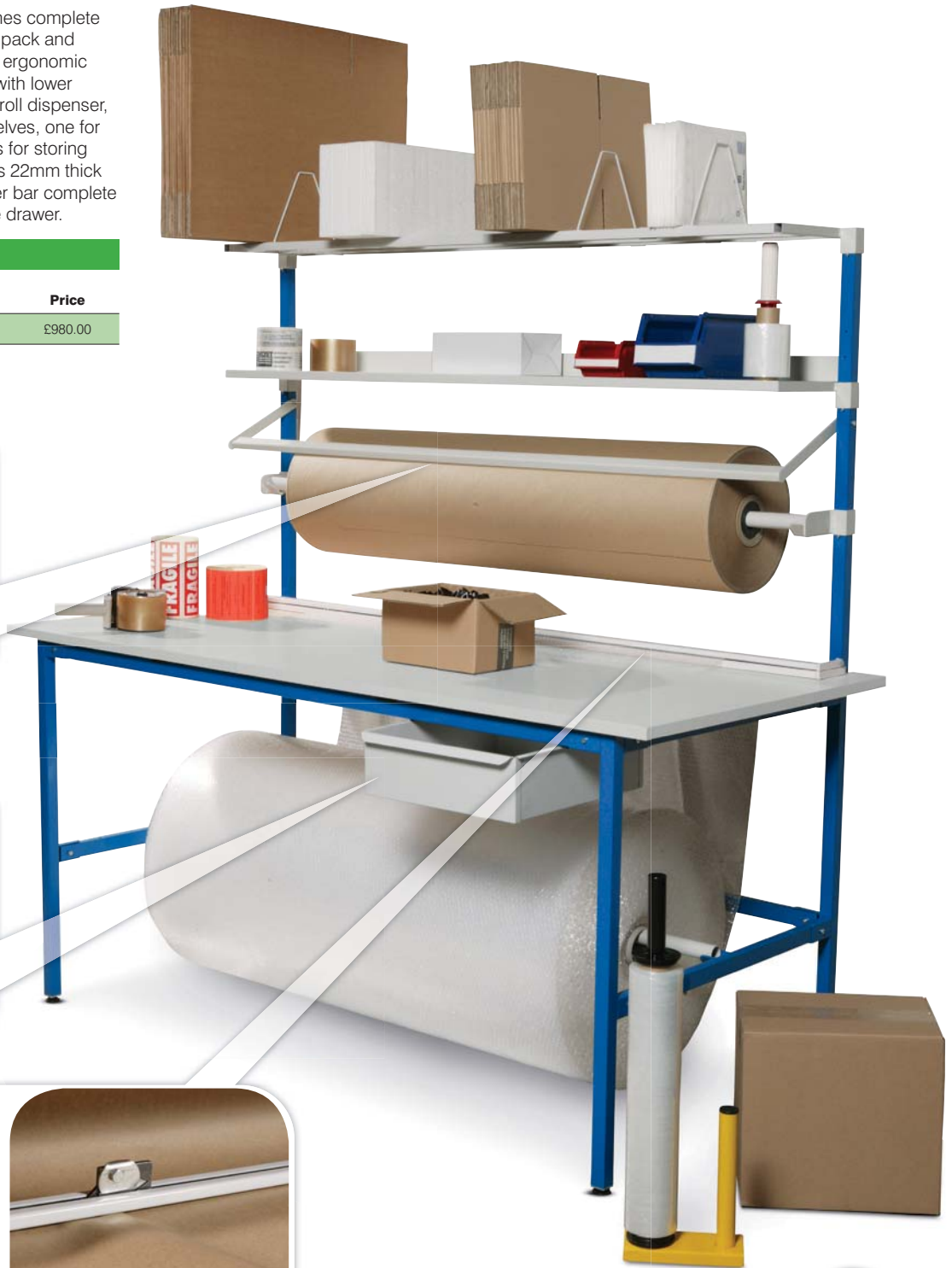

### Key Features and Benefits



- ★ Everything you need to pack orders
- ★ Two packaging roll dispensers
- ★ Two storage shelves and dividers
- ★ Cutting bar and under desk drawer

### Have you seen...



Plastic bins p.84



## Rivet Rack Packing Bench

Great packing benches in two different styles, complete lower bubble wrap dispenser, upper paper roll dispenser. The benches also come with upper storage level for additional storage and depending on the bench configuration you get a lower storage level as well.

### Key Features and Benefits

- ★ Cost effective packing stations
- ★ Two packaging roll dispensers
- ★ Additional storage shelves



### Wide Packing Workstation

Size (mm) H x W x D	Code	Load kgs	Price
1830 x 1525 x 915	RRWPS/18/15/09/03	300	£237.80
1830 x 1830 x 915	RRWPS/18/18/09/03	300	£264.10



### Long Packing Workstation

Size (mm) H x W x D	Code	Load kgs	Price
1830 x 915 x 1830	RRLPS/18/09/18/03	300	£258.40
1830 x 915 x 2135	RRLPS/18/09/21/03	300	£273.85
1830 x 1220 x 1830	RRLPS/18/12/18/03	300	£279.70
1830 x 1220 x 2135	RRLPS/18/12/21/03	300	£290.45

## Mobile Workbench

Our new Heavy Duty Mobile workbench blends the simplicity of our standard RIVET style workbenches bolted to a fully welded frame, offering a sturdy and robust solution to any workplace. The bench can be fitted with a choice of 3 worktops and the base comes with heavy duty nylon swivel castors (two braked and two un-braked).

Other sizes are available to order – 4 weeks lead time



### Heavy Duty Mobile Workbench - 18mm chipboard

Size (mm) H x W x D	Code	Shelf Load	Price
965 x 1830 x 762	HDMB/09/18/07	150	£350.05
965 x 1830 x 915	HDMB/09/18/09	150	£432.90

other sizes are available to order - 4 week delivery

### Light Duty Mobile Workbench - 18mm chipboard

Size (mm) H x W x D	Code	Shelf Load	Price
930 x 1220 x 610	RRMB/09/12/06	50	£184.80
930 x 1220 x 762	RRMB/09/12/07	50	£191.80
930 x 1525 x 610	RRMB/09/15/06	50	£194.80
930 x 1525 x 762	RRMB/09/15/07	50	£203.00
930 x 1830 x 610	RRMB/09/18/06	50	£216.10
930 x 1830 x 762	RRMB/09/18/07	50	£226.50

### 3 Worktops Available



Chipboard (Included)

MDF (+20%)

Light Grey MFC (+30%)



## Trolley Shelving

Looking for a flexible storage solution? Then our range of mobile trolley shelving provides the perfect answer. Move goods safely and easily between work areas, making stock moveable, easy to replenish and secure. The fully welded base can support an array of the different bay sizes and configurations as well as each shelf being either a tray to stop goods falling off or a standard shelf (please specify when ordering).

### Key Features and Benefits

- ★ Provide flexible storage solution
- ★ Fully welded base with castors
- ★ Move goods between work areas
- ★ Maximum bay load of 300kgs
- ★ Other sizes and specials available



Shelf Tray



Fully Welded Frame



### Have you seen...



Heavy Rivet p.8

### All Bays c/w 4 Shelves

Size (mm) H x W x D	Code	Bay Load	Price
1830 x 915 x 610	TRB/18/09/06/4	300	£272.35
1830 x 915 x 762	TRB/18/09/07/4	300	£309.10

To order please see back cover



## Platform Trolleys

Our modular range of platform trolleys allow you to mix and match bases, ends and sides to make the perfect materials handling solution to suit your needs. The ends simply locate into the platform tubular frame and are held securely by a sprung bolt, which can be pressed to change the style of the end panel. The trolleys have been designed to withstand the demands of even the toughest warehouse environments, having a capacity of 500kgs and a wheel diameter of 200mm and a solid rubber tyre. The platform base is available in two sizes and they come complete with two braked swivel castors and two un-braked fixed castors. We have five different styles of end frame that are compatible with all three side panels. We also have a range of mesh panels that can make open or fully enclosed Parcel Cages with adjustable shelves.

### Key Features



- ★ **A flexible modular system**
- ★ **Interchangeable end and side panels**
- ★ **Heavy Duty Design – 500kgs loading**
- ★ **Complies to EN 1757-3**
- ★ **2 Swivel braked and 2 fixed un-braked castors**



### Side Panels



### End Panels



## Key Features



- ★ A flexible modular system
- ★ Interchangeable end and side panels
- ★ Fully enclosed secure cage with doors
- ★ Heavy duty design – 500kgs loading
- ★ Complies to EN 1757-3
- ★ 2 Braked and 2 Un-braked Castors
- ★ Overall height 1875mm
- ★ Steel framed shelves with MDF tops



Optional Handle



Parcel Cart - Open two side



Parcel Cart - Open one side + 2 shelf



Parcel Cart - Enclosed + 2 shelf

## Roll Cages

Description	Size (mm) W x D x H	Capacity kgs	Code	Price
Parcel Cart - Open two side	1300 x 676 x 1875	500	XPC/1207/OP	£406.05
Parcel Cart - Open one side + 2 shelf	1300 x 676 x 1875	500	XPC/1207/OP/3/2	£627.70
Parcel Cart - Enclosed + 2 shelf	1300 x 676 x 1875	500	XPC/1207/OP/4/2	£944.85

# PLATFORM TROLLEYS

## Key Features & Benefits

- ★ A flexible modular system
- ★ Interchangeable end and side panels
- ★ Heavy duty design – 500kgs loading
- ★ Complies to EN 1757-3
- ★ 2 Braked and 2 Un-braked Castors

from  
**£197.<sup>60</sup>**

**1** Plain

UDL  
**500**  
kg



**2** Tubular



**3** Mesh



**4** Wood



### One End Panels

Model	End/Side Panel	Platform Size L x W (mm)	Code	Price
1	Plain	1000 x 700	XTP/1007/1PE	£197.60
1	Plain	1200 x 700	XTP/1207/1PE	£202.60
2	Tubular	1000 x 700	XTP/1007/1TE	£205.70
2	Tubular	1200 x 700	XTP/1207/1TE	£210.65
3	Mesh	1000 x 700	XTP/1007/1ME	£218.15
3	Mesh	1200 x 700	XTP/1207/1ME	£223.15
4	Wood	1000 x 700	XTP/1007/1WE	£213.95
4	Wood	1200 x 700	XTP/1207/1WE	£218.90

500kgs load capacity



from  
**£213.<sup>25</sup>**

UDL  
**500**  
kg



**1** Plain



**2** Tubular



**3** Mesh



**4** Wood

### Two End Panels

Model	End/Side Panel	Platform Size L x W (mm)	Code	Price
1	Plain	1000 x 700	XTP/1007/2PE	£213.25
1	Plain	1200 x 700	XTP/1207/2PE	£218.20
2	Tubular	1000 x 700	XTP/1007/2TE	£229.40
2	Tubular	1200 x 700	XTP/1207/2TE	£234.35
3	Mesh	1000 x 700	XTP/1007/2ME	£254.35
3	Mesh	1200 x 700	XTP/1207/2ME	£259.30
4	Wood	1000 x 700	XTP/1007/2WE	£245.85
4	Wood	1200 x 700	XTP/1207/2WE	£250.80

500kgs load capacity

# PLATFORM TROLLEYS



## Two End and One Side Panels

Model	End/Side Panel	Platform Size L x W (mm)	Code	Price
1	Tubular	1000 x 700	XTP/1007/2TE/1TS	£251.90
1	Tubular	1200 x 700	XTP/1207/2TE/1TS	£259.10
2	Mesh	1000 x 700	XTP/1007/2ME/1MS	£288.50
2	Mesh	1200 x 700	XTP/1207/2ME/1MS	£295.80
3	Wood	1000 x 700	XTP/1007/2WE/1WS	£276.35
3	Wood	1200 x 700	XTP/1207/2WE/1WS	£282.85

500kgs load capacity

## Two End and Two Side Panels

Model	End/Side Panel	Platform Size L x W (mm)	Code	Price
1	Tubular	1000 x 700	XTP/1007/2TE/2TS	£274.40
1	Tubular	1200 x 700	XTP/1207/2TE/2TS	£283.85
2	Mesh	1000 x 700	XTP/1007/2ME/2MS	£322.60
2	Mesh	1200 x 700	XTP/1207/2ME/2MS	£332.30
3	Wood	1000 x 700	XTP/1007/2WE/2WS	£306.85
3	Wood	1200 x 700	XTP/1207/2WE/2WS	£314.95

500kgs load capacity





from  
**£227.00**

## Key Features & Benefits

- ★ A flexible modular system
- ★ Interchangeable end and side panels
- ★ Heavy duty design – 500kgs loading
- ★ Complies to EN 1757-3
- ★ 2 Braked and 2 Un-braked Castors



**1** Tubular



**3** Wood



**2** Mesh



### Two Sided Panels

Model	End/Side Panel	Platform Size L x W (mm)	Code	Price
1	Tubular	1000 x 700	XTP/1007/2TS	£258.25
1	Tubular	1200 x 700	XTP/1207/2TS	£267.70
2	Mesh	1000 x 700	XTP/1007/2MS	£281.50
2	Mesh	1200 x 700	XTP/1207/2MS	£291.20
3	Wood	1000 x 700	XTP/1007/2WS	£274.25
3	Wood	1200 x 700	XTP/1207/2WS	£282.30

500kgs load capacity

### Have you seen...



**Mesh Partitioning**  
p.106 - 107





## Compact Trucks

Unfold in seconds  
Lightweight, simple to use and easy to carry  
Aluminium construction  
Can be stored or transported in confined spaces making them ideal for deliveries



### Compact Trucks

Description	Model	Load Cap. kgs	Overall Size H x W X D (mm)	Size Folded H x W X D (mm)	Toe Plate W x D (mm)	Weight Kgs	Order More - Save More! 1+	Order More - Save More! 2+
Mini Compact	GI025Y	60	1000 x 400 x 420	650 x 390 x 60	390 x 240	3	£54.35	£49.95
Super Compact	GI033Y	100	1000 x 490 x 450	700 x 490 x 60	490 x 270	4	£79.95	£77.75



## Folding Box Trucks

Holds footscap and lever arch files and box files  
Durable Plastic construction  
Opens and folds in seconds  
Folds flat for easy carrying and storage

Maximum load capacity is 35kg  
Folds to a depth of just 85mm  
GI042Y comes complete with removable lid



### Folding Box Truck

Description	Model	Overall Size H x W X D (mm)	Size Folded H x W X D (mm)	Internal Size H x W x D (mm)	Weight Kgs	Order More - Save More! 1+	Order More - Save More! 3+
Folding Box Truck - Blue/Yellow	GI041Y	990 x 460 x 390	470 x 460 x 85	350 x 395 x 330	4	£29.95	£27.50
Folding Box Truck With Lid - Grey/Red	GI042Y	990 x 460 x 390	470 x 460 x 85	350 x 395 x 330	5	£34.65	£30.30

## Heavy Duty Aluminium Sack Truck

Quickly and easily folds for compact storage and transportation

The toe plate, wheels and handles fold into the sack truck with a simple move of the handles

2 x 200mm puncture-proof Rubber wheels

Folds in one simple movement: Simply turn the handles towards the sack truck. This will then allow the toe plate to lift and the wheels to fold into the compact mode - ideal for storage/transportation



Folds in one swift movement



Easy tilt mechanism

Fitted with large wheel guards



## Aluminium Sack Truck

Skids enable this unit to be placed horizontally for ease of loading and unloading.

250mm pneumatic wheels.



### Aluminium Sack Truck

Model	Load Cap. kgs	Overall Size H x W X D (mm)	Toe Plate W x D (mm)	Weight Kgs	Price	
GI270H	270	1150 x 480 x 520	1165 x 435 x 145	310 x 310	6	£139.30
GI661P	150	1170 x 495 x 510	305 x 234	9	£119.95	





**NEW**

GUARANTEED  
5 DAYS  
DELIVERY

## Budget Sack Trucks

Lightweight  
200mm rubber wheels  
Hardwearing finish

UDL  
**100 kg**

### Budget Sack Trucks

Description	Model	Load Cap. kgs	Overall Size H x W X D (mm)	Toe Plate W x D (mm)	Weight Kgs	Price
Budget Sack Truck	GI256H	100	1120 x 470 x 410	350 x 228	11	£44.75
With Hand Grips	GI258H	100	1000 x 470 x 410	350 x 180	10	£39.95



UDL  
**120 kg**

**NEW**

GUARANTEED  
5 DAYS  
DELIVERY

UDL  
**150 kg**

## Steel Sack Trucks

Lightweight, hard wearing powder coated sack truck units fitted with knuckle guard hand grips for added protection

### Steel Sack Trucks

Wheels	Model	Load Cap. kgs	Overall Size H x W X D (mm)	Toe Plate W x D (mm)	Weight Kgs	Price
200mm Cushion	GI521H	120	1135 x 480 x 445	350 x 200	11.5	£60.70
250mm Pneumatic	GI523P	150	1120 x 545 x 435	350 x 185	11	£63.45

GUARANTEED  
5 DAYS  
DELIVERY

UDL  
**150 kg**

**NEW**

## Sack Truck with Skids

Concave cross members

Skids allow the unit to be laid horizontally for ease of loading and unloading

Large 250mm pneumatic wheels to give these units a smooth ride over rough and uneven terrain



### Sack Trucks with Skids

Model	Load Cap. kgs	Overall Size H x W X D (mm)	Toe Plate W x D (mm)	Weight Kgs	Price
GI669P	150	1185 x 504 x 535	350 x 220	11	£61.55



GI157H

**NEW**

GUARANTEED  
5 DAYS  
DELIVERY

GI157P

UDL  
**300 kg**

## Heavy Duty Sack Trucks

Hardwearing powder coat finish  
Knuckle guard hand grips and wheel guards

GI157H: 200mm rubber wheels with steel centres

GI157P: 260mm pneumatic wheels

### Heavy Duty Sack Trucks

Wheels	Model	Load Cap. kgs	Overall Size H x W (mm)	Toe Plate W x D (mm)	Weight Kgs	Price
200mm Rubber	GI157H	300	1168 x 550	390 x 300	19.5	£99.95
260mm Pneumatic	GI157P	300	1168 x 550	390 x 300	19.5	£105.95

# SACK TRUCKS



## Folding Sack Trucks

Lightweight yet strong folding sack truck ideal for delivering goods in the office, warehouse and retail environment.

This unit is excellent for storing in a car boot or van.

Toe plate size: 300 x 380mm

### Folding Sack Trucks

Description	Model	Load Cap. kgs	Overall Size H x W (mm)	Weight Kgs	Price
Straight Frame	GI151Y	100	1020 x 360	5	£59.95



## Heavy Duty Folding Sack Truck

Strong, robust, versatile and fully welded

Easily folded - ideal for storing in a car/van

Mobile on 200mm rubber tyred wheels - roller bearing

UK Manufactured with a 3 Year Guarantee

### Heavy Duty Folding Sack Truck

Model	Load Cap. kgs	Overall Size H x W (mm)	Toe Plate W x D (mm)	Weight Kgs	Price
FJ182H	200	960 x 500	310 x 330	10	£102.95

## Heavy Duty Steel Sack Truck with Folding Toe

Fully welded, strong and robust

Heavy duty, industrial hammerite finish

250mm pneumatic tyred wheels with high speed carbon steel ball bearing

Fixed and folding toe plates

Folding toe plate size: 300W x 425Dmm

Incorporates knuckle guard hand grips and wheel guards



Folding Toe Plate stays in folded position by the use of a magnet



### Heavy Duty Steel Sack Truck with Folding Toe

Model	Load Cap. kgs	Overall Size H x W x D (mm)	Toe Plate W x D (mm)	Weight Kgs	Price
GI893P	250	1230 x 590 x 450	390 x 200	12	£75.00

## Heavy Duty 'Bulky' Sack Truck

Large robust and puncture proof semi-pneumatic 350mm wheels to give this unit a smooth ride over rough and uneven terrain

Heavy duty 'Bulky' load sack truck is a massive 1310Hmm x 560Wmm

Fixed & folding toe plates

Folding Toe Plate Size: 450W x 600Dmm

Ideal for rough and tough applications



Complete with strap



### Heavy Duty 'Bulky' Sack Truck

Model	Load Cap. kgs	Overall Size H x W x D (mm)	Fixed Toe Plate W x D (mm)	Weight Kgs	Price
GI400P	400	1310 x 665 x 470	665 x 195	20	£104.95





Fixed & folding  
Toe plate

## Two Way Cargo Truck

Converts from a sack truck to a platform truck in seconds  
Mobile on 250mm pneumatic wheels and 100mm swivel castors  
Self assembly



Two Way Cargo Truck							
Model	Load Cap. kgs	Overall Size Sack Truck Mode L x W x H mm	Overall Size Platform Truck Mode L x W x H mm	Fixed Toe Plate W x D (mm)	Weight Kgs	Price	
GI358Y	200	450 x 550 x 1240	980 x 550 x 890	350 x 180	12	£75.65	



## Wide Stairclimber

Fixed and folding toe plates  
Complete with adjustable strap  
Folding Toe Plate Size: 395 x 460mm  
Mounted on 160mm wheels on a '3' star system  
Max Load: 50kg on stairs  
150kg as a sack truck



Wide Stairclimber						
Model	Load Cap. kgs	Overall Size H x W x D mm	Fixed Toe Plate W x D (mm)	Weight Kgs	Price	
GI360Y	150	1160 x 605 x 795	410 x 200	22	£129.95	

## Three Way Truck

A multi-purpose truck which easily and quickly converts from a basic sack truck to a 4 wheel sack truck or platform truck  
Fitted with 2 x 200mm rubber tyred wheels and 2 x 125mm rubber tyred castors  
Horizontal Platform Height: 260mm  
Toe Plate Size: 470 x 190mm

Converts quickly and easily to 3 positions



Three Way Truck							
Model	Load Cap. kgs	As Platform Truck H x L (mm)	As 4 Wheel Sack Truck H x L (mm)	As Basic Sack Truck H (mm)	Weight Kgs	Price	
GI135Y	250	710 x 1280	840 x 1205	1280	19	£99.95	



## Multi Position Trolley

- Manufactured from aluminium
- Telescopic handle
- Expanding and contracting base
- Fits easily into a car boot/van
- Corner buffers for added protection
- Mobile on 100mm castors



### Multi Position Trolley

Model	Load Cap. kgs	Overall Size L x W x H (mm)	Overall Size Folded L x W x H (mm)	Weight Kgs	Price
GI001Y	150	725 x 420 x 960	570 x 420 x 230	8.5	£65.70



## Pro-Dek Heavy Duty Platform Trolleys With Quiet Castors

- Heavy duty plastic trolley with corner buffers
- Can be stacked 5 high for easy storage
- Complete with mechanism protectors
- GI918Y: mobile on 2 fixed & 2 swivel braked 100mm non-marking rubber 'QuietCastors'
- GI919Y: mobile on 2 fixed & 2 swivel braked 125mm non-marking rubber 'QuietCastors'



### Pro-Dek Heavy Duty Platform Trolleys With Quiet Castors

Model	Load Cap. kgs	Overall Size L x W x H (mm)	Overall Size Folded L x W x H (mm)	Weight Kgs	Price
GI918Y	200	740 x 468 x 930	740 x 468 x 274	8.5	£99.95
GI919Y	350	900 x 610 x 945	900 x 610 x 298	13	£149.50

GI919Y



## Large Wheeled Folding Trolley

- Foldable handle makes this unit easy to store
- Heavy duty 200mm 2 fixed and 2 swivel pneumatic wheels - ideal for rough terrain



### Large Wheeled Folding Trolley

Model	Load Cap. kgs	Overall Size L x W x H (mm)	Weight Kgs	Price
GI009P	350	870 x 560 x 900	22	£139.95



Mechanism protector



GIK02Y folded



High quality smooth running castors

## Deluxe Folding Trolleys

- Yellow Foam handle for your comfort
- Flat pressed sheet steel base with PVC surface
- GIK02Y: mobile on 100mm 2 fixed and 2 swivel castors
- GIK03Y: mobile on 125mm 2 fixed and 2 swivel castors



### Deluxe Folding Trolleys

Model	Load Cap. kgs	Overall Size L x W x H (mm)	Weight Kgs	Price
GIK02Y	160	720 x 470 x 830	9.5	£69.50
GIK03Y	300	904 x 604 x 870	16.5	£103.60





## Multi Purpose Shelf Trolley

Load Capacity: 20kg on top tray and 40kg on bottom tray

Manufactured to the recognised European GS Standard

Manufactured from injection moulded Plastic & anodised Aluminium

Folded Size: 110L x 470W x 670Hmm

The unit even has a foot operated brake between the rear wheels

Complete with a folding box



### Multi Purpose Shelf Trolley

Model	Description	Overall Size L x W X H (mm)	Weight kg	Price
GC051Y	Clever Folding Trolley	890 x 550 x 1030	7	£178.80

## Plastic Shelf Trolley

Hygienic - easy to clean

Clearance between shelves: 280mm

Plastic shelves with strong Aluminium uprights

25mm lip on 3 sides & a 5mm rim on 1 side

Mobile on 4 swivel non-marking Rubber castors



HI424Y & HI004Z



HI424Y

### Set of 2 Buckets:

1 x 332L x 232W x 172H and

1 x 336L x 236W x 562H mm

### Plastic Shelf Trolley

Model	Load Capacity kgs	Overall Size L x W X H (mm)	Wheel Size (mm)	Weight kg	Price
HI424Y	100	850 x 420 x 910	75	8	£99.95

### Trolley Buckets

Model	Description	Price
HI004Z	Optional Buckets for HI424Y (must be ordered with the HI424Y)	£32.95

## Multi Purpose Shelf Trolley

Super Strong Polyethylene Moulded Trolley

Easy to clean, versatile - will not rust, dent or chip

Ideal for use in workshops, storerooms, warehouses, chemical & pharmaceutical industries

Manufactured from a non conductive Polyethylene which will not pass an electrical current & is unaffected by battery acid, solvents & cleaning solutions

Mobile on 4 x 100mm non marking Rubber swivel castors, 2 with brakes

10 Year Guarantee

Supplied Knock Down but comes with a free mallet for easy assembly



GI334L



GI341L

### Multi Purpose Shelf Trolley

Model	Description	No. of Shelves	Load Capacity kgs	Overall Size L x W X H (mm)	Size between Shelves (mm)	Weight kg	Price
GI334L	Plastic Multi Purpose Trolley	2	150	890 x 610 x 880	650	16	£192.45
GI335L	Plastic Multi Purpose Trolley	3	150	890 x 610 x 865	292 / 292	22	£235.55
GI341L	Plastic Multi Purpose Trolley	3	150	610 x 458 x 840	305 / 305	11	£129.95

To order please see back cover   



UDL  
**150**  
kg

## Steel Kick Step

Of Steel construction, this Kick Step has a snap-lock quick assembly and non-slip Rubber platforms

Lightweight and incorporates a non-slip platform

Mounted on 3 retractable Polypropylene castors

This Kick Step will not slide, roll or tip over

6 Colour Options available: Blue, Red, Black, Grey, Yellow, Green - Please specify when ordering



### Steel Kick Step

Model	Loaded Height (mm)	Unloaded Height (mm)	Base Dia (mm)	Top Dia (mm)	Weight Kg	Order More - Save More!	
						1+	3+
KA004Z	430	435	435	290	4.5	£36.95	£33.95



## Rugged Plastic Kick Step

Manufactured in high quality durable Plastic, this kick step is lightweight and easy to move. The unit incorporates 3 sprung loaded castors which retract when weight is applied

Base Diameter: 430mm, Top Diameter: 290mm

150kg Load Capacity, Ideal for those hard to reach areas

### Rugged Plastic Kick Step

Model	Loaded Height (mm)	Unloaded Height (mm)	Weight Kg	Order More - Save More!	
				1+	3+
KA007Z	410	420	3.5	£32.50	£29.95



3 tread  
GS403Z

4 tread  
GS404Z



2 tread  
GS402Z

## Folding Steps with Foam Handle

Approved to the recognised European GS Standard and comply to EN-14183 Standard

Tubular Steel construction, fitted with non-slip treads, Plastic feet and Black Foam Rubber handle, giving a comfortable backing when used as a seat

Tread Size: 380W x 260Dmm

### Folding Steps with Foam Handle

Model	No of Treads	Height of Top Tread (mm)	Overall Size Open H x W x D (mm)	Overall Size Folded H x W x D (mm)	Weight Kg	Price
GS403Z	3	725	1180 x 460 x 670	1310 x 460 x 90	6	£57.95
GS404Z	4	980	1435 x 500 x 850	1580 x 500 x 90	8	£72.45





## Easy Slope Aluminium Folding Leader Steps

Aluminium folding steps are ideal for use in offices, storerooms, warehouses etc

Manufactured to GS Approval 'the recognised European standard'

Large serrated Aluminium treads (360W x 205Dmm) and high handrail offer increased safety during use

Tilt & Pull wheels for easy movement without lifting

Easy Slope incline

Folded Size: only 120mm deep



2 Step Folded - AFGS2Z



Integral wheels for easy moving

2 tread AFGS2Z



Integral tool holder, bucket hook and screw tray



3 tread AFGS3Z



4 tread AFGS4Z

### Easy Slope Aluminium Folding Leader Steps

Model	No of Treads	Platform Height (mm)	Overall Size Open H x W x D (mm)	Overall Height Folded (mm)	Weight Kg	Price
AFGS2Z	2	440	850 x 520 x 545	790	6.5	£96.95
AFGS3Z	3	660	1240 x 550 x 830	1060	9	£116.30
AFGS4Z	4	880	1440 x 580 x 1110	1360	11	£140.25

## Double Decker

Comply to EN-131 Standard

Integral toolholder, bucket hook and screw tray

A quality professional Aluminium stepladder, light enough to facilitate easy movement and transportation

The Aluminium platform features a Red safety strip - indicator for maximum recommended step height and protective edge to prevent cuts and grazes

Patented large double step underneath the platform for safe and comfortable standing

The unit comes complete with heavy-duty sturdy Rubber anti-slip feet to make this a superior, professional, stepladder

5 Year Guarantee

### Double Decker

Model	No of Treads	Platform Height (mm)	Overall Size Open H x W x D (mm)	Overall Height Folded (mm)	Weight Kg	Price
ALT-502103	3	616	1244 x 470 x 723	1426	3.8	£73.50
ALT-502104	4	828	1461 x 496 x 869	1656	4.4	£80.70
ALT-502105	5	1041	1677 x 525 x 1016	1887	5	£89.95
ALT-502106	6	1253	1893 x 552 x 1163	2117	6.1	£99.95
ALT-502107	7	1465	2110 x 580 x 1309	2348	7.2	£111.70
ALT-502108	8	1677	2326 x 607 x 1456	2529	8.4	£122.90



Large platform with protective edging



Integral tool holder, bucket hook and screw tray



from  
**£69.95**

ALT-502105





## Fort Stable Steps

Manufactured & Approved to the recognised European GS Standard.

Certified to EN 14183

Platform Size: 200D x 396W mm

Open mesh treads facilitates safe use with muddy boots & in dirty environments

Robust, ergonomic & heavy duty grey rubber non-marking grounding feet make these units extremely stable

UK Manufactured with 3 Year Guarantee



GS3113M In Use



GS3012M

### Fort Stable Steps

Description & No. of Treads	Platform Height (mm)	Overall Size Open H x W x D mm	Weight Kg	Options	Code	Price
2 Step, No Handrail, Painted	400	436 x 450 x 606	7		GS3002M	£72.40
2 Step, With Handrail, Painted	400	990 x 450 x 606	7	Handrail	GS3012M	£84.20
2 Step, With Handrail & Wheels Painted	400	990 x 450 x 686	8	Handrail & rear wheel	GS3112M	£94.30
3 Step, No Handrail, Painted	600	636 x 450 x 806	11		GS3003M	£101.00
3 Step, With Handrail, Painted	600	1190 x 450 x 806	11	Handrail	GS3013M	£114.70
3 Step, With Handrail & Wheels Painted	600	1190 x 450 x 886	12	Handrail & rear wheel	GS3113M	£124.70



3 tread WM7013

## Fort Mobile Steps

Mesh Treads, size: 400W x 150D mm

Mobile on 4 sprung loaded 75mm Grey, non-marking castors

UK Manufactured with 3 Year Guarantee



3 tread WM7013



4 tread WM7014

5 tread WM7015

### Fort Mobile Steps

Description & No. of Treads	Platform Height (mm)	Platform Size W x D mm	Overall Size Open H x W x D mm	Weight Kg	Model	Price
3 Step with full handrail	750	400 x 300	1480 x 540 x 720	17	WM7013	£273.85
4 Step with full handrail	1000	400 x 300	1730 x 550 x 870	20	WM7014	£310.35
5 Step with full handrail	1250	400 x 300	1980 x 665 x 1020	25	WM7015	£341.75
6 Step with full handrail	1500	400 x 300	2230 x 750 x 1170	28	WM7016	£374.85



## Fort Mobile Step

Mesh Treads or Ribbed Rubber Treads

Non-slip ribbed Rubber tread which is clamped to the Steel tread by a high visibility Yellow strip to prevent the edges peeling

Tread Size: 400W x 150D mm

These steps glide easily across floors, but once body weight is applied they stay firmly in position

UK Manufactured with 3 Year Guarantee



Sprung wheels stay in place when weight is applied



Ribbed rubber clamped to steel treads

3 tread mesh WM513



Mesh Tread

### Fort Mobile Steps

Description & No. of Treads	Platform Height (mm)	Platform Size W x D mm	Overall Size Open H x W x D mm	Weight Kg	Model (Mesh Treads)	Price	Model (Rubber Treads)	Price
2 Step with full handrail	500	400 x 300	960 x 560 x 575	10	WM512	£197.40	WS512	£212.20
3 Step with full handrail	750	400 x 300	1460 x 560 x 725	13	WM513	£231.80	WS513	£249.35
4 Step with full handrail	1000	400 x 300	1710 x 560 x 875	16	WM514	£273.90	WS514	£294.05
5 Step with full handrail	1250	400 x 300	1960 x 610 x 1025	21	WM515	£325.70	WS515	£349.70

## Fort Spring Steps

Manufactured & Approved to the recognised European GS Standard.

Certified to EN 131.

Tread Depth: 145D mm.

Platform Size: 400W x 300D mm.

Powder coated finish.

Mobile on two 150mm Rubber tyred rear wheels and two 75mm spring loaded swivel castors.

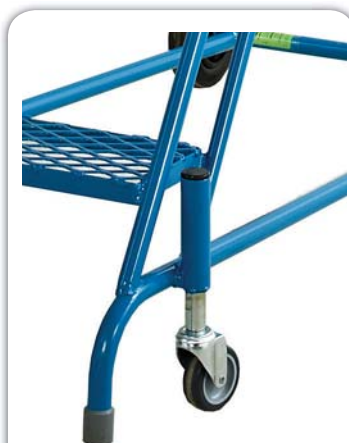

Mobile on 2 spring loaded 75mm swivel castors & 2 x 150mm rubber tyred wheels.

When body weight is applied the castors retract leaving the steps firm & safe on rubber feet



GSS704M

### Fort Spring Steps

Description & No. of Treads	Platform Height (mm)	Overall Size Open H x W x D mm	Weight Kg	Code	Price
4 Step - Mesh	1000	1710 x 600 x 1244	22	GSS704M	£303.70
6 Step - Mesh	1500	2210 x 660 x 1668	26	GSS706M	£394.85
8 Step - Mesh	2000	2710 x 720 x 2029	30	GSS708M	£496.65

## Heavy Duty Range

All sizes fit louvre panels

ARTB50

ARTB60

ARTB40



- 1 Slot in dividers for bins 3, 4, 5 and 6
- 2 Full length rear lip for louvre panels
- 3 Reinforced side walls to stop spreading
- 4 Extra wide and reinforced stacking base
- 5 Moulded finger grips for greater comfort
- 6 Large label are for better identification
- 7 Stop to prevent stacked bins slipping



**Plastic Bins**  
Labels included

Plastic Bins				
Size (mm) W x D x H	Code	Colour	LP Value (w x h)	Price
106 x 106 x 49	ARTB05	Red,Blue,Yellow	1.5 x 2	£0.65
106 x 136 x 76	ARTB10	Red,Blue,Yellow	1.5 x 2	£0.80
106 x 187 x 76	ARTB20	Red,Blue,Yellow	1.5 x 2	£1.05
140 x 205 x 127	ARTB25	Red,Blue,Yellow	2 x 3	£2.05
140 x 274 x 127	ARTB30	Red,Blue,Yellow	2 x 3	£2.75
210 x 375 x 179	ARTB40	Red,Blue,Yellow	3 x 4	£6.25
280 x 457 x 254	ARTB50	Red,Blue,Yellow	4 x 6	£11.60
415 x 370 x 179	ARTB60	Red,Blue,Yellow	6 x 4	£10.75

Please state colour when ordering. All sizes fit louvre panels

Louvre Panel				
Size (mm) H x W	Code	Colour	LP Value (w x h)	Price
500 x 500	ARTBPLV0505	Galv	6 x 9	£14.50
1000 x 500	ARTBPLV1005P	Galv	6 x 19	£28.00
500 x 1000	ARTBPLV0510L	Galv	13 x 9	£28.00

Dividers			
Size (mm) W x D x H	Code	Colour	Price
274 x 127	ARTBDIV3	Black	£0.75
375 x 179	ARTBDIV4	Black	£1.20
457 x 254	ARTBDIV5	Black	£2.10
370 x 179	ARTBDIV6	Black	£1.20

## Recycled Rhino Tuff Bins

The best bin on the market is now available in recycled plastic, saving 15% on the price of our coloured range. The bins are available in the 6 most popular sizes and all have our no quibble lifetime guarantee. All delivered with 5 working at an amazing price and quality.

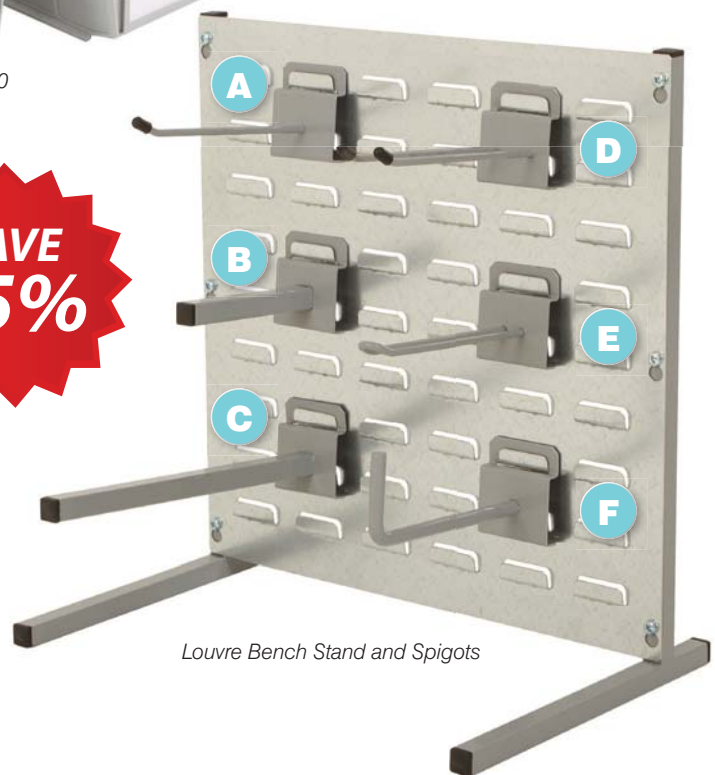

Louvre Panel

Louvre Bench Stand and Spigots

### Plastic Bins

Size (mm) W x D x H	Code	Colour	LP Value (w x h)	Price
106 x 136 x 76	ARTB10	Light grey	1.5 x 2	£0.70
106 x 187 x 76	ARTB20	Light grey	1.5 x 2	£0.90
140 x 205 x 127	ARTB25	Light grey	2 x 3	£1.75
140 x 274 x 127	ARTB30	Light grey	2 x 3	£2.35
210 x 375 x 179	ARTB40	Light grey	3 x 4	£5.30
280 x 457 x 254	ARTB50	Light grey	4 x 6	£9.85

### Spigots

Size (mm) W x D x H	Ref	Code	Colour	LP Value (w x h)	Price
Single prong 200mm	A	ARTBSPSP200	Grey	1 x 2	£5.60
Square tube 150mm	B	ARTBSPST150	Grey	1 x 2	£6.30
Square tube 300mm	C	ARTBSPST300	Grey	1 x 2	£7.80
Double prong 200mm	D	ARTBSPDP200	Grey	1 x 2	£8.60
Euro hook 200mm	E	ARTBSPEK200	Grey	1 x 2	£6.50
Steel hook 200mm	F	ARTBSPHK200	Grey	1 x 2	£7.40

### Louvre Panel

500h x 500w	ARTBPLV0505	Galv	6 x 9	£14.50
1000h x 500w	ARTBPLV1005P	Galv	6 x 19	£28.00
500h x 1000w	ARTBPLV0510L	Galv	13 x 9	£28.00

### Have you seen...

**ESD Containers**  
p.100-101



# PLASTIC BIN WALL KITS



**A Wall Kit**  
KITWA  
1000 x 500mm louvre panel with 6 BIN40 and 6 BIN30



**B Wall Kit**  
KITWB  
1000 x 500mm louvre panel with 9 BIN30, 12 BIN20 and 8 BIN10



**C Wall Kit**  
KITWC  
1000 x 500mm louvre panel with 18 BIN30



**D Wall Kit**  
KITWD  
1000 x 500mm louvre panel with 36 BIN20



**E Wall Kit**  
KITWE  
1000 x 500mm louvre panel with 3 BIN25, 3 BIN30 2 BIN40 and 2 BIN60



**F Wall Kit**  
KITWF  
1000 x 500mm louvre panel with 8 BIN10, 8 BIN20, 6 BIN25 and 6 BIN30



**G Wall Kit**  
KITWG  
1000 x 500mm louvre panel with 5 BIN60



**H Wall Kit**  
KITWH  
1000 x 500mm louvre panel with 10 BIN40

## Wall Kits

Item	Size (mm) H x W	Code	Price
Wall Kit A	1000 x 500	ARTBKITWA	£82.00
Wall Kit B	1000 x 500	ARTBKITWB	£71.75
Wall Kit C	1000 x 500	ARTBKITWC	£77.50
Wall Kit D	1000 x 500	ARTBKITWD	£65.80
Wall Kit E	1000 x 500	ARTBKITWE	£76.40
Wall Kit F	1000 x 500	ARTBKITWF	£71.60
Wall Kit G	1000 x 500	ARTBKITWG	£81.75
Wall Kit H	1000 x 500	ARTBKITWH	£90.50

labels included



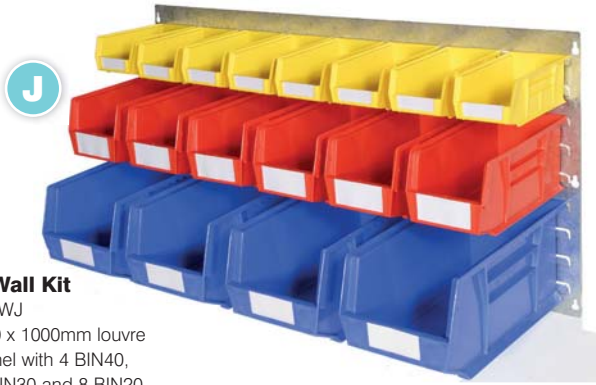

**J Wall Kit**  
KITWJ  
500 x 1000mm louvre panel with 4 BIN40, 6 BIN30 and 8 BIN20



**K Wall Kit**  
KITWK  
500 x 1000mm louvre panel with 6 BIN30, 6 BIN25, 8 BIN20 and 8 BIN10



**L Wall Kit**  
KITWL  
500 x 1000mm louvre panel with 6 BIN25, 8 BIN20, 8 BIN10 and 8 BIN05



**M Wall Kit**  
KITWM  
500 x 1000mm louvre panel with 4 BIN40, 6 BIN30 and 6 BIN25



**N Wall or Bench Kit**  
500 x 500mm louvre panel with 3 BIN30, 8 BIN20 and 4 BIN10



**P Wall or Bench Kit**  
500 x 500mm louvre panel with 3 BIN30, 3 BIN25 and 4 BIN10



**Q Wall or Bench Kit**  
500 x 500mm louvre panel with 9 BIN30

**NEW LOWER PRICE**



**S Wall or Bench Kit**  
500 x 500mm louvre panel with 3 BIN25, 4 BIN20, 4 BIN10 and 4 BIN05



**T Wall or Bench Kit**  
500 x 500mm louvre panel with 16 BIN20

## Wall Kits

Item	Size (mm) H x W	Code	Price
Wall Kit J	500 x 1000	ARTBKITWJ	£77.90
Wall Kit K	500 x 1000	ARTBKITWK	£71.60
Wall Kit L	500 x 1000	ARTBKITWL	£60.30
Wall Kit M	500 x 1000	ARTBKITWM	£81.80
Wall Kit N	500 x 500	ARTBKITWN	£34.35
Wall Kit P	500 x 500	ARTBKITWP	£32.10
Wall Kit Q	500 x 500	ARTBKITWQ	£39.25
Wall Kit S	500 x 500	ARTBKITWS	£30.65
Wall Kit T	500 x 500	ARTBKITWT	£31.30
Bench Stand Kit N	500 x 500	ARTBKITBN	£59.85
Bench Stand Kit P	500 x 500	ARTBKITBP	£57.60
Bench Stand Kit Q	500 x 500	ARTBKITBQ	£64.75
Bench Stand Kit S	500 x 500	ARTBKITBS	£56.15
Bench Stand Kit T	500 x 500	ARTBKITBT	£56.80

labels included

## Louvre Racks

Our range of louvre racks provide an efficient way to organise small parts bins which include every size from our Rhino Tuff range. The racks provide a simple way to organise small part storage bins, providing a high density storage solutions whilst maintaining an efficient way to retrieve items from the picking face. The frames are made from strong box section profiles finished in light grey RAL7038 and the louvre panels from hard wearing galvanised steel. The units can be configured as stand-alone bays or built in runs using a starter and extension bays in either single or double sided formats.



- Key Features and Benefits:**
- ★ Heavy duty racks and trolleys
  - ★ Single or double sided racks
  - ★ Build as starter and extension bays
  - ★ Mobile units offer greater flexibility
  - ★ Hard wearing painted frames
  - ★ Tough galvanised louvre panels

Louvre Racks			
Item	Size (mm)	Code	Price
Rack single sided starter	1880 x 930	ARTBRKSSS	£282.75
Rack single sided extension	1880 x 930	ARTBRKSSE	£195.15
Rack double sided starter	1880 x 930	ARTBRKDSS	£399.15
Rack double sided extension	1880 x 930	ARTBRKDSE	£327.65

## Louvre Trolley

Save wasted time travelling to items stored in static shelving installations by putting all your small part storage bins onto our Louvre Trolleys. Each trolley has been designed to perform to the highest standards with a robust frame design and tough galvanised louvre panels. Each unit comes with an ergonomic plastic handle so the unit can be comfortably moved. The trolley is fitted with heavy duty swivel castors, which offers ease of movement and with two of the castors being braked, this means the trolley is secure when not in use.



Louvre Trolley			
Item	Size (mm)	Code	Price
Trolley double sided	1400 x 930	ARTBTY	£407.10



Key Features and Benefits:



- ★ Heavy duty racks and trolleys
- ★ Single or double sided racks
- ★ Mobile units offer flexible storage
- ★ Epoxy powder frames
- ★ Tough galvanised louvre panels

## Bin Trolleys

Trolley  
ARTBTY  
No bins



from  
**£544.<sup>70</sup>**

Bin Trolley A  
ARTBTYA  
96 x Bin 2  
48 x Bin 3



Bin Trolley B  
ARTBTYB  
32 x Bin 1  
48 x Bin 2  
24 x Bin 3  
16 x Bin 4



### Bin Trolleys

Item	Size (mm)	Code	Price
Bin Trolley A	1400 x 930	ARTBTYA	£639.90
Bin Trolley B	1400 x 930	ARTBTYB	£669.90

## Bin Racks

Rack  
(single sided)  
ARTBRKSS  
No bins



from  
**£350.<sup>95</sup>**

Rack  
(double sided)  
ARTBRKDS  
No bins

Bin Rack B  
(single sided)  
ARTBRKSSB  
32 x Bin 2  
24 x Bin 3  
16 x Bin 4

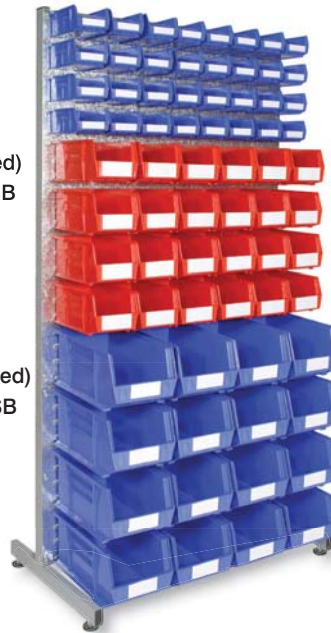

Bin Rack B  
(double sided)  
ARTBRKDSB  
64 x Bin 2  
48 x Bin 3  
32 x Bin 4

Bin Rack A  
(single sided)  
ARTBRKSSA  
16 x Bin 1  
24 x Bin 2  
12 x Bin 3  
8 x Bin 4  
6 x Bin 5



Bin Rack A  
(double sided)  
ARTBRKDSA  
32 x Bin 1  
48 x Bin 2  
24 x Bin 3  
16 x Bin 4  
12 x Bin 5

Bin Rack C  
(single sided)  
ARTBRKSSC  
24 x Bin 1  
24 x Bin 2  
24 x Bin 3  
12 x Bin 4

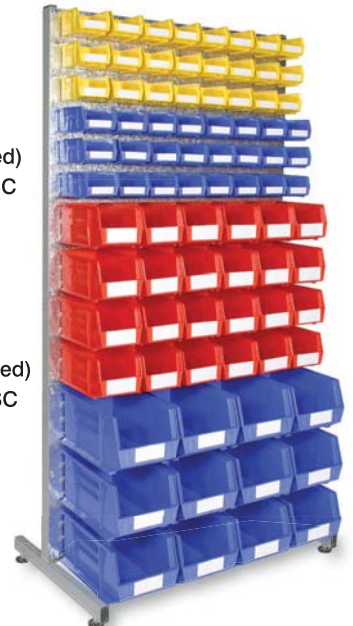

Bin Rack C  
(double sided)  
ARTBRKDCS  
48 x Bin 1  
48 x Bin 2  
48 x Bin 3  
24 x Bin 4

### Bin Racks

Item		Size (mm)	Code	Price
Bin Rack A	Single sided starter	1880 x 930	ARTBRKSSSA	£473.35
Bin Rack A	Single sided extension	1880 x 930	ARTBRKSSEA	£385.75
Bin Rack A	Double sided starter	1880 x 930	ARTBRKDSSA	£780.35
Bin Rack A	Double sided extension	1880 x 930	ARTBRKDSEA	£708.85
Bin Rack B	Single sided starter	1880 x 930	ARTBRKSSSB	£482.35
Bin Rack B	Single sided extension	1880 x 930	ARTBRKSSEB	£394.75
Bin Rack B	Double sided starter	1880 x 930	ARTBRKDSSA	£798.35
Bin Rack B	Double sided extension	1880 x 930	ARTBRKDSEA	£726.85
Bin Rack C	Single sided starter	1880 x 930	ARTBRKSSSC	£468.15
Bin Rack C	Single sided extension	1880 x 930	ARTBRKSSEC	£380.55
Bin Rack C	Double sided starter	1880 x 930	ARTBRKDCSSC	£769.95
Bin Rack C	Double sided extension	1880 x 930	ARTBRKDCSEC	£698.45



## Expo 4 Bays

A new range of EXPO 4 boltless shelving bays with our new Heavy duty "RHINO TUFF" plastic storage bins. All bays come complete as open side and back units 2000mm high with all plastic bins and labels.



### EXRH01

Expo 4 bay 2000mm high with 9 shelves 1150 x 400mm fitted with 40 No. BIN4.

**EXRH03**  
Expo 4 bay 2000mm high with 7 shelves 1000 x 500mm fitted with 18 No. BIN5.

from  
**£489.<sup>10</sup>**



### EXRH02

Expo 4 bay 2000mm high with 10 shelves 1150 x 400mm fitted with 32 No. BIN3 and 25No. BIN4.



### EXRH04

Expo 4 bay 2000mm high with 11 shelves 1150 x 300mm fitted with 80 No. BIN3.

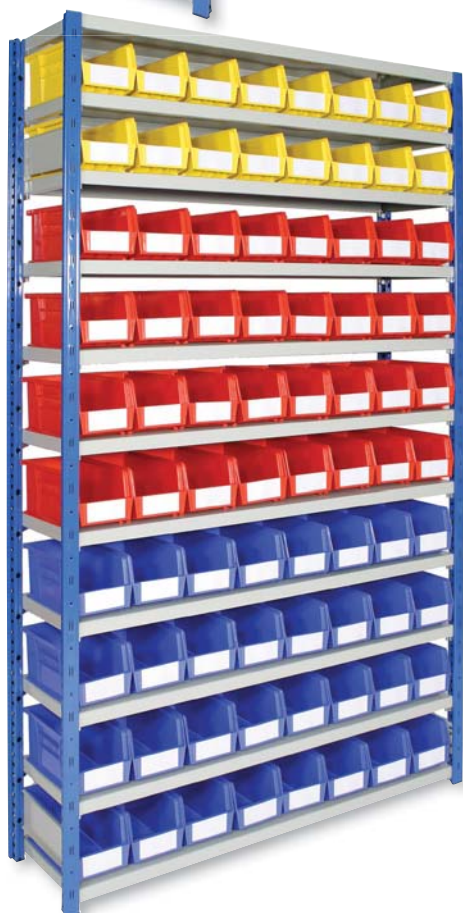

### Expo 4 Bays

Item	Size (mm)	Code	Price
Expo 4 bay with bins	2000 x 1150 x 400	ARTBEXRH01	£575.30
Expo 4 bay with bins	2000 x 1150 x 400	ARTBEXRH02	£598.25
Expo 4 bay with bins	2000 x 1000 x 500	ARTBEXRH03	£489.10
Expo 4 bay with bins	2000 x 1150 x 300	ARTBEXRH04	£505.95

# Rivet Bays with Storage Bins

A new range of bays complete with our most popular heavy duty "RHINO TUFF" storage bins

The bins all sit on either J or Z Rivet bays and offer excellent value for money. The rivet bays have excellent strength and rigidity and offer full access on all four sides. There is a range of bays that have back to back bins offering picking from both faces from one single bay.

## Rivet Bays with Storage Bins

Item	Size (mm)	Code	Price
J Rivet bay with bins	1830 x 915 x 305	ARTBJRRH01	£206.65
J Rivet bay with bins	1830 x 915 x 457	ARTBJRRH02	£285.35
J Rivet bay with bins	1830 x 915 x 457	ARTBJRRH03	£224.55
J Rivet bay with bins	1830 x 915 x 610	ARTBJRRH04	£360.35
Z Rivet bay with bins	1830 x 915 x 762	ARTBZRRH05	£555.50
Z Rivet bay with bins	1830 x 915 x 915	ARTBZRRH06	£461.40



**JRRH01**  
J Rivet bay 1830mm high with 5 shelves  
915 x 305mm fitted 48 No. ARTB30.



**JRRH02**  
J Rivet bay 1830mm high with 5 shelves  
915 x 457mm fitted 32 No. ARTB40.



**JRRH03**  
J Rivet bay 1830mm high with 5 shelves  
915 x 457mm fitted 12 No. ARTB50.



**JRRH04**  
J Rivet bay 1830mm high with 5 shelves  
915 x 610mm fitted 96 No. ARTB30.



**ZRRH05**  
Z Rivet bay 1830mm high with 5 shelves  
915 x 762mm fitted 64 No. ARTB40.



**ZRRH06**  
Z Rivet bay 1830mm high with 5 shelves  
915 x 915mm fitted 24 No. ARTB50.

## Chrome Trolleys

These Chrome wire shelving trolleys and bins provide a perfect storage solution for production and assembly environments, where goods need to be moved line side or to the point of use. There are 5 kit styles in three versions, providing single or double sided options using our most popular RHINO TUFF picking bins. We can supply all 5 kits in the coloured range of bins whilst the Kits A to D can come in either Recycled Light Grey or ESD Black. The trolley that holds the ESD containers will be fitted with conductive castors and metal collars to make it fully ESD compliant.



**B**

**Double sided 4 Shelf Trolley with 48 x BIN30**

Size (mm) H x W X D	Code	Bin Type	Price
990 x 915 x 460	CWSTB/B/CD	Coloured	£305.70
990 x 915 x 460	CWSTB/B/RG	Recycled grey	£286.50
990 x 915 x 460	CWSTB/B/EB	ESD Black	£399.90



**A**

**Double sided 4 Shelf Trolley with 48 x BIN25**

Size (mm) H x W X D	Code	Bin Type	Price
990 x 915 x 460	CWSTB/A/CD	Coloured	£246.70
990 x 915 x 460	CWSTB/A/RG	Recycled Grey	£232.30
990 x 915 x 460	CWSTB/A/EB	ESD Black	£340.90



**C**

**Single sided 3 Shelf Trolley with 12 x BIN40**

Size (mm) H x W X D	Code	Bin Type	Price
990 x 915 x 460	CWSTB/C/CD	Coloured	£200.90
990 x 915 x 460	CWSTB/C/RG	Recycled grey	£189.50
990 x 915 x 460	CWSTB/C/EB	ESD Black	£288.50



**D**

**Single sided 3 Shelf Trolley with 9 x BIN50**

Size (mm) H x W X D	Code	Bin Type	Price
990 x 915 x 460	CWSTB/D/CD	Coloured	£230.30
990 x 915 x 460	CWSTB/D/RG	Recycled grey	£214.55
990 x 915 x 460	CWSTB/D/EB	ESD Black	£317.90

Height to top box - 1060mm



**E**

**Single sided 3 Shelf Trolley with 6 x BIN60**

Size (mm) H x W X D	Code	Bin Type	Price
990 x 915 x 460	CWSTB/E/CD	Coloured	£190.40

\*ESD Trolleys are equipped with ESD castors and metal collars



## KanBan Shelving

Rivet racking KanBan is our solution for production line-side supply systems, where sloping shelves present containers for easy access and at the right height for operatives. This can reduce costs and increase efficiency for manufacturing operations or inventory management. The two bin arrangement simplifies stock rotation and replacement. When the front bin is removed the bin behind takes its place, leaving a space that is clearly identified for refilling on the next inspection.

### KanBan Shelving:

Please call us to discuss your requirements.

from  
**£283.<sup>60</sup>**



**RRKB01**

Rivet racking bay 1830mm high with 5 levels of sloping shelves with 60 plastic bins (BIN3).



**RRKB03**

Rivet racking bay 1830mm high with 3 levels of sloping shelves with 8 euro containers (EC04).



**RRKB02**

Rivet racking bay 1830mm high with 5 levels of sloping shelves with 70 Shelf trays (ST3109).



### KanBan Shelving

Item	Size (mm)	Code	Price
KanBan Shelving	1830 x 915 x 610	RRKB01	£321.20
KanBan Shelving	1830 x 915 x 610	RRKB02	£429.00
KanBan Shelving	1830 x 915 x 610	RRKB03	£283.60

To order please see back cover   



**ONLY**  
**£296.<sup>00</sup>**



## Industrial Cupboards

Strong fully welded industrial cupboards that offer excellent security whilst keeping products clean and safe. Choice of two sizes that come complete with fully adjustable shelves, locks with two keys and all finished in a high quality anti-bacterial paint finish. The doors come with additional strengthening and a secure two point locking bar and a low profile door handle. Standard delivery will be 5 days but if you need them faster then just add £10.00 to your order.



*Lockable  
2 keys supplied*



*Two point  
locking rod*



*Adjustable  
Shelves*

Size H x W x D (mm)	Shelves	Code	Price
1780 x 915 x 460	3	CD/18/09/04/3	£352.00
1015 x 915 x 460	1	CD/10/09/04/1	£248.00

## Industrial Steel Cupboards Complete with Bins

Our new range of industrial strength cupboards, come complete with our 'Rhino Tuff' plastic storage bins. The cupboards are manufactured to withstand the wear and tear of industrial use and provide a safe and secure way to store your inventory. The lockable doors also provide a clean and dust free environment for storing any sensitive items or just to keep stock clean and tidy.



Size H x W x D (mm)	Bins	Code	Price
1020 x 915 x 460	16 BIN40	CDWB/10/C	£387.00



Size H x W x D (mm)	Bins	Code	Price
1020 x 915 x 460	8 BIN60	CDWB/10/A	£373.00



Size H x W x D (mm)	Bins	Code	Price
1020 x 915 x 460	8 BIN40 & 18 BIN30	CDWB/10/D	£386.50



Size H x W x D (mm)	Bins	Code	Price
1020 x 915 x 460	4 BIN60 & 8 BIN40	CDWB/10/B	£380.00



Size H x W x D (mm)	Bins	Code	Price
1020 x 915 x 460	36 BIN30	CDWB/10/E	£386.00



## Full Height Cupboards Complete with Bins



Size H x W x D (mm)	Bins	Code	Price
1800 x 915 x 460	4 BIN60, 8 BIN40 & 36 BIN30	CDWB/18/F	£601.00



from  
**£581.00**

Size H x W x D (mm)	Bins	Code	Price
1800 x 915 x 460	32 BIN40	CDWB/18/G	£609.00



Size H x W x D (mm)	Bins	Code	Price
1800 x 915 x 460	16 BIN40 and 36 BIN30	CDWB/18/H	£595.00



Size H x W x D (mm)	Bins	Code	Price
1800 x 915 x 460	16 BIN60	CDWB/18/J	£581.00



Size H x W x D (mm)	Bins	Code	Price
1800 x 915 x 460	16 BIN40 and 36 BIN30	CDWB/18/K	£608.00



Size H x W x D (mm)	Bins	Code	Price
1800 x 915 x 460	72 BIN30	CDWB/18/L	£607.00

# SHELF TRAYS



**A** - Part Height Unit  
16 No. 117 x 90 trays, 12 No. 234 x 90 trays, 12 No. 234 x 140 trays  
Shelf trays c/w label and shelf stop/handle - available 300, 400 and 500mm deep.



**B** - Part Height Unit  
64 No. 117 x 90 trays  
Shelf trays c/w label and shelf stop/handle - available 300, 400 and 500mm deep.



**C** - Part Height Unit  
32 No. 234 x 90 trays  
Shelf trays c/w label and shelf stop/handle - available 300, 400 and 500mm deep.



**D** - Part Height Unit  
28 No. 234 x 140 trays  
Shelf trays c/w label and shelf stop/handle - available 300, 400 and 500mm deep.



**E** - Full Height Unit  
32 No. 117 x 90 trays, 16 No. 234 x 90 trays, 20 No. 234 x 140 trays  
Shelf trays c/w label and shelf stop/handle - available 300, 400 and 500mm deep.

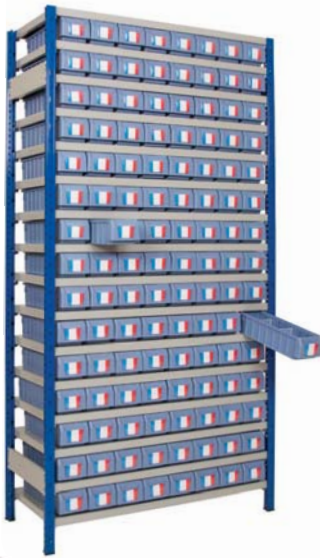

**F** - Full Height Unit  
120 No. 117 x 90 trays  
Shelf trays c/w label and shelf stop/handle - available 300, 400 and 500mm deep.



**G** - Full Height Unit  
60 No. 234 x 90 trays  
Shelf trays c/w label and shelf stop/handle - available 300, 400 and 500mm deep.



**H** - Full Height Unit  
44 No. 234 x 140 trays  
Shelf trays c/w label and shelf stop/handle - available 300, 400 and 500mm deep.

## Expo 4 with Shelf Trays All bays 2000mm high x 1000mm wide

### 300mm - shelf capacity 110kgs UDL

Item	Description	Code	Price
STA03	BAY A	Blue/Grey	£570.00
STB03	BAY B	Blue/Grey	£630.75
STC03	BAY C	Blue/Grey	£525.15
STD03	BAY D	Blue/Grey	£519.10
STE03	BAY E	Blue/Grey	£818.75
STF03	BAY F	Blue/Grey	£1,031.45
STG03	BAY G	Blue/Grey	£833.45
STH03	BAY H	Blue/Grey	£704.55

### 400mm - shelf capacity 90kgs UDL

Item	Description	Code	Price
STA04	BAY A	Blue/Grey	£692.35
STB04	BAY B	Blue/Grey	£763.60
STC04	BAY C	Blue/Grey	£640.40
STD04	BAY D	Blue/Grey	£628.60
STE04	BAY E	Blue/Grey	£995.35
STF04	BAY F	Blue/Grey	£1,251.75
STG04	BAY G	Blue/Grey	£1,020.75
STH04	BAY H	Blue/Grey	£853.75

### 500mm - shelf capacity 80kgs UDL

Item	Description	Code	Price
STA05	BAY A	Blue/Grey	£787.10
STB05	BAY B	Blue/Grey	£850.45
STC05	BAY C	Blue/Grey	£727.25
STD05	BAY D	Blue/Grey	£724.65
STE05	BAY E	Blue/Grey	£1,134.70
STF05	BAY F	Blue/Grey	£1,396.50
STG05	BAY G	Blue/Grey	£1,165.50
STH05	BAY H	Blue/Grey	£990.40



## Shelf Trays:

Our shelf tray range has been completely redesigned. It is now stronger, easier to use and great value!



## Key Features and Benefits:

- ★ **New more competitive design**
- ★ **Improved strength and rigidity**
- ★ **More ergonomic features**
- ★ **Sprung loaded shelf stop**
- ★ **Can be sub divided**
- ★ **High density storage system**
- ★ **Offers faster retrieval times**
- ★ **Large range of sizes**
- ★ **Goods are kept clean**
- ★ **Better product identification**

NEW Shelf Stop/Handle



Plastic cover

## Shelf Trays

Our shelf tray range has been completely redesigned with many new features that make it stronger, more competitive and easier to use. The biggest improvement is the addition of a sprung loaded shelf stop at the back of the tray.

This means the tray can be withdrawn from the shelf and suspended offering around 90% clear picking. This stop also acts as handle to make it is to carry.

With shelf trays available 3 depths and 2 widths and 2 heights, any configuration can be designed to offer the maximum high density storage solution.

Trays can be sub divided from left to right and all trays and dividers come with labels.

### Shelf Trays

Item	Code	Colour	Price
300 x 117 x 90	ST3109	Light Blue	£3.85
300 x 234 x 90	ST3209	Light Blue	£5.80
300 x 234 x 140	ST3214	Light Blue	£7.30
400 x 117 x 90	ST4109	Light Blue	£4.90
400 x 234 x 90	ST4209	Light Blue	£7.30
400 x 234 x 140	ST4214	Light Blue	£9.10
500 x 117 x 90	ST5109	Light Blue	£5.60
500 x 234 x 90	ST5209	Light Blue	£8.75
500 x 234 x 140	ST5214	Light Blue	£11.15

### Dividers

117 x 90	STDIV109	Translucent	£0.65
234 x 90	STDIV209	Translucent	£1.00
234 x 140	STDIV214	Translucent	£1.30

### Handels

117	STHAN117	Chrome	£1.70
234	STHAN234	Chrome	£2.05

from  
**£3.<sup>85</sup>**



Slot in dividers

## Premium Distribution Containers

Heavy duty attached alligator style lidded containers made from first grade polypropylene. Our premium range has been designed for industry but also suited for office moves, with foolscap lever arch files fitting perfectly. The containers are designed to provide safe transit & storage of a variety of goods as well as being able to stack and nest to save valuable space when returned or not in use. They have extra reinforced lids for safer stacking and protection of the goods stored and have either areas for adhesive labels or label indicators. The lids come with two locations at each end so tamper evident seals, cable ties and padlocks can be fitted.



### Premium Distribution Containers

Description	Size (mm) L x W x H	Volume (litres)	Code	Colour	Price
Premium Distribution Containers	600 x 400 x 320	60	DC02	Blue	£25.90
Dolly	525 x 355 x 135		EC43DOLLY	Yellow/Aluminium	£50.05



## Industrial Distribution Containers

Our Industrial Distribution container or ALC which with the strong sturdy design, large label area, ergonomic handles and alligator lid make it ideal for any distribution application, office or house move as well as for general storage. The containers come with a large slot in label holder a hole each end for tamper evident seals, cable ties or padlocks.



### Industrial Distribution Containers

Description	Size (mm) L x W x H	Volume (litres)	Code	Colour	Price
Industrial Distribution Containers	610 x 415 x 320	58	DC01	Grey	£24.40
Dolly	545 x 370 x 135		EC43DOLLY	Yellow/Aluminium	£50.05



**NEW**



## Euro Containers

Our NEW high-quality Euro norm series of stacking euro containers can be used for the food and non-food sector. They provide excellent value and performance due to the diversity of variants, the light, yet very stable construction using polypropylene copolymer. The containers are available in many different sizes and configurations, with nine solid side versions all with open handles that are available from stock and delivered within 5 days. We can also supply a variety of other models including ventilated sides, closed handles, four base configurations, dollies and hinged lids. Please contact the sales office for prices and lead times.

### Key Features and Benefits:

- ★ High quality light grey Euro containers
- ★ Will fit 800x600, 1000x800 and 1200x1000 pallets
- ★ Reinforced side and corners for extra strength
- ★ Ergonomic open handles on two sides
- ★ Can be used on automatic conveying systems
- ★ Interlocking design for safe and secure stacking
- ★ Base and Lids can be fitted with tamper evident seals

#### Solid Side and Base

Size (mm) L x W x H	Inner Size (mm) L x W x H	Volume (litres)	Code	Colour	Price
400 x 300 x 170	367 x 268 x 167	15.9	EBS/4317/OH/GY	Grey	£8.50
400 x 300 x 220	367 x 268 x 217	20.8	EBS/4322/OH/GY	Grey	£10.15
400 x 300 x 280	367 x 268 x 277	25.6	EBS/4328/OH/GY	Grey	£12.20
600 x 400 x 120	567 x 367 x 117	23.9	EBS/6412/OH/GY	Grey	£11.35
600 x 400 x 170	567 x 367 x 167	35.6	EBS/6417/OH/GY	Grey	£13.80
600 x 400 x 220	567 x 367 x 217	44.2	EBS/6422/OH/GY	Grey	£16.80
600 x 400 x 270	567 x 367 x 267	54.4	EBS/6427/OH/GY	Grey	£20.15
600 x 400 x 320	567 x 367 x 317	64.5	EBS/6432/OH/GY	Grey	£22.20

All with open handle

#### Open Short Side

Size (mm) L x W x H	Inner Size (mm) L x W x H	Volume (litres)	Code	Colour	Price
600 x 400 x 320	567 x 367 x 317	64.5	EBSCT/6432/GY	Grey	£22.75

#### Lid

Size (mm) L x W x H	Code	Colour	Price
400 x 300	EBS/43/LID/GY	Grey	£4.75
600 x 400	EBS/43/LID/GY	Grey	£6.05

#### Dolly

Size (mm) L x W x H	Code	Colour	Price
400 x 300 x 135	EC43DOLLY	Yellow/Aluminium	£45.05
600 x 400 x 135	EC64DOLLY	Yellow/Aluminium	£50.05

To order please see back cover   

## Electro-Static Discharge Storage Bins

A range of ESD Plastic Containers which are made from special conductive plastic. The bins are specifically designed for transporting or storing sensitive electronic devices or components that need to have static electricity dissipated. Available in 6 sizes and manufactured from a non-pigmented anti-static additive.

### Key Features and Benefits:

- ★ Strong design for Heavy duty use
- ★ Reinforced base, sides and stacking rim
- ★ Resistant to solvents and high temperatures
- ★ Front label for instant product identification



#### ARTB10

W=106  
D=136  
H=76



#### ARTB20

W=106  
D=187  
H=76



#### ARTB25

W=140  
D=205  
H=127



#### ARTB30

W=140  
D=274  
H=127



#### ARTB40

W=210  
D=375  
H=179



#### ARTB50

W=280  
D=457  
H=254



### Plastic Bins

Size W x D x H (mm)	Code	Colour	LP Value (W x H)	Price
106 x 136 x 76	ARTB10/AS	black	1.5 x 2	£1.80
106 x 187 x 76	ARTB20/AS	black	1.5 x 2	£2.60
140 x 205 x 127	ARTB25/AS	black	2 x 3	£4.95
140 x 274 x 127	ARTB30/AS	black	2 x 3	£6.90
210 x 375 x 179	ARTB40/AS	black	3 x 4	£15.00
280 x 457 x 254	ARTB50/AS	black	4 x 6	£28.95

### Louvre Panel

500h x 500w	ARTBPLV0505	Galv	6 across x 9 down	£14.50
1000h x 500w	ARTBPLV1005P	Galv	6 across x 19 down	£28.00
500h x 1000w	ARTBPLV0510L	Galv	13 across x 9 down	£28.00

### Size H x W x D(mm)

Size H x W x D(mm)	Code	Price
970 x 915 x 460	CWASSKIT2	£166.15
970 x 915 x 610	CWASSKIT3	£186.25

Each kit has three shelves, four uprights 854mm, metal collars, trolley handle, two braked and unbraked anti-static castors. (bay capacity 210kgs)



## ESD Chrome Wire Shelving

Our ESD chrome wire shelving is available in the full range of sizes and accessories. The simple metal collars and metal foot plate ensure that the bays allow ESD at all times. We also offer braked and un-braked castors increasing the flexibility of this storage solution. All components are available ex-stock and can be delivered within 5 days along with our ESD plastic storage bins.

### Key Features and Benefits:



- ★ **ESD shelving solutions**
- ★ **Simple to build and adjust**
- ★ **Wide range of accessories**
- ★ **ESD trolleys and castors**

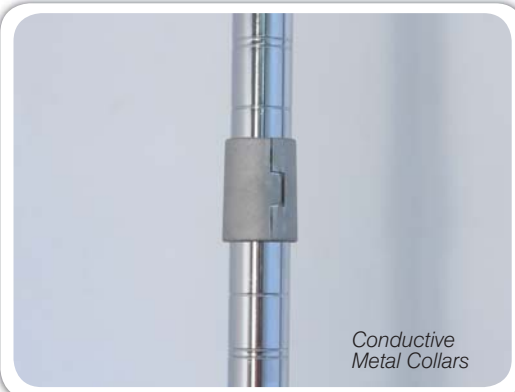

All bays come with 4 shelves per bay and all necessary metal collars and metal adjustable feet

Size H x W x D (mm)	Code	Starter Price	Code	Extension Price	Code	Shelf Price	Shelf Load (kg)
1590 x 915 x 355	CWS/15/09/03/4	£119.60	CWE/15/09/03/4	£116.30	CWS2/09/03	£20.75	300
1590 x 1220 x 355	CWS/15/12/03/4	£138.95	CWE/15/12/03/4	£135.65	CWS2/12/03	£25.60	240
1590 x 1525 x 355	CWS/15/15/03/4	£158.50	CWE/15/15/03/4	£155.20	CWS2/15/03	£30.50	190
1590 x 460 x 460	CWS/15/04/04/4	£104.20	CWE/15/04/04/4	£100.90	CWS2/04/04	£16.90	270
1590 x 915 x 460	CWS/15/09/04/4	£132.55	CWE/15/09/04/4	£129.25	CWS2/09/04	£24.00	270
1590 x 1220 x 460	CWS/15/12/04/4	£154.55	CWE/15/12/04/4	£151.25	CWS2/12/04	£29.50	220
1590 x 1525 x 460R*	CWS/15/15/04/4	£188.65	CWE/15/15/04/4	£185.35	CWS2/15/04R	£38.05	200
1590 x 610 x 610	CWS/15/06/06/4	£127.70	CWE/15/06/06/4	£124.40	CWS2/06/06	£22.80	240
1590 x 915 x 610	CWS/15/09/06/4	£158.10	CWE/15/09/06/4	£154.80	CWS2/09/06	£30.40	240
1590 x 1220 x 610	CWS/15/12/06/4	£189.75	CWE/15/12/06/4	£186.45	CWS2/12/06	£38.30	190
1590 x 1525 x 610R*	CWS/15/15/06/4	£245.40	CWE/15/15/06/4	£242.10	CWS2/15/06R	£52.25	180

R = reinforced with one central truss

### Taller bays add

Bays 1895mm high	CWS/18/--/--/4	£5.50	CWE/18/--/--/4	£2.75
Bays 2200mm high	CWS/22/--/--/4	£10.80	CWE/22/--/--/4	£5.40

To order please see back cover



## Express Lockers

Quality compartment lockers suitable for a multitude of storage applications. Express lockers provide the flexibility of two sizes with four door options. The Express Locker is supplied with a light grey carcass and either light grey or dark blue doors.



**Huge stocks waiting for immediate despatch**



### Key Features & Benefits



- ★ **Choice of 300mm and 450mm widths.**
- ★ **1, 2, 4 and 6 door lockers fitted with security shelf to prevent any unauthorised access to the compartment below.**
- ★ **Fitted with standard, mastered cam locks with 2,000 differs.**
- ★ **Single tier lockers fitted with top shelf and coat hook.**
- ★ **Two tier lockers fitted with coat hook in each compartment.**
- ★ **Strengthened and ventilated doors with rubber buffers.**
- ★ **Powder coated with Germ Guard Active Technology.**
- ★ **Supplied with anti corrosive galvanised shelves.**
- ★ **Order quantities may apply, please speak to sales.**



1 tier

2 tiers

4 tiers

6 tiers

### Locker - Light Grey Doors

Size (mm) H x W x D	Tiers	Code	Order More - Save More!		
			1+	3+	6+
1800 x 300 x 300	1	LQ1830301LXX	£90.25	£79.80	£76.00
1800 x 300 x 300	2	LQ1830302LXX	£102.60	£90.25	£86.45
1800 x 300 x 300	4	LQ1830304LXX	£123.50	£109.25	£104.50
1800 x 300 x 300	6	LQ1830306LXX	£151.05	£133.00	£127.30
1800 x 300 x 450	1	LQ1830451LXX	£100.70	£88.35	£84.55
1800 x 300 x 450	2	LQ1830452LXX	£113.05	£99.75	£95.00
1800 x 300 x 450	4	LQ1830454LXX	£127.30	£112.10	£106.40
1800 x 300 x 450	6	LQ1830456LXX	£157.35	£138.46	£132.92



1 tier



2 tiers

from  
**£76.00**



4 tiers



6 tiers



Coat hook and shelf detail

**Locker - Blue Doors**

Size (mm) H x W x D	Tiers	Code	Order More - Save More!		
			1+	3+	6+
1800 x 300 x 300	1	LQ1830301BXX	£90.25	£79.80	£76.00
1800 x 300 x 300	2	LQ1830302BXX	£102.60	£90.25	£86.45
1800 x 300 x 300	4	LQ1830304BXX	£123.50	£109.25	£104.50
1800 x 300 x 300	6	LQ1830306BXX	£151.05	£133.00	£127.30
1800 x 300 x 450	1	LQ1830451BXX	£100.70	£88.35	£84.55
1800 x 300 x 450	2	LQ1830452BXX	£113.05	£99.75	£95.00
1800 x 300 x 450	4	LQ1830454BXX	£127.30	£112.10	£106.40
1800 x 300 x 450	6	LQ1830456BXX	£157.35	£138.46	£132.92



## Magnetic Label Holders and Self Adhesive Label Holders

Magnetic holders are ideal for applications where regular changes are required or self adhesive for more permanent requirement. Each holder is supplied in pre-cut lengths and come complete with card and cover strip.

### Magnetic Label Holders

Size (mm) H x W	Code	Pack	Price
20 x 80	ML28X	100	£35.70
30 x 80	ML38	100	£42.90
40 x 80	ML48	100	£56.70
50 x 80	ML58	100	£69.90

Black PVC extrusion

### Self-Adhesive Label Holders

Size (mm) H x W	Code	Pack	Price
15 x 80	AL18	100	£38.40
30 x 80	AL38	100	£52.20
50 x 80	AL58	100	£64.50

White PVC extrusion

### Key Features & Benefits

- ★ **Instant visible rack identification**  
Choose either magnetic or self-adhesive
- ★ **Easy to insert & update**  
Simple slide in card & cover
- ★ **Suitable for many applications**  
Magnetic holders are ideal for cold stores
- ★ **Many sizes available from stock**  
Pre-cut lengths for quick despatch



## Magnetic Ticket Holders and Self Adhesive Ticket Holders

Designed to be used with printed labels and bar codes, the easy pull forward front panel makes changing labels easy. No need to remove the label when scanning.

### Magnetic Ticket Holders

Size (mm) H x W	Code	Pack	Price
25 x 100	TS210M	100	£71.10
38 x 100	TS310M	100	£75.00
54 x 100	TS510M	100	£89.10
80 x 200	TS820M	50	£87.60

Clear PVC with magnetic strip

### Self-Adhesive Ticket Holders

Size (mm) H x W	Code	Pack	Price
25 x 100	TS210	100	£40.50
38 x 100	TS310	100	£43.80
54 x 100	TS510	100	£60.60
80 x 200	TS820	50	£61.20

Clear PVC with aggressive adhesive backing



### Key Features & Benefits

- ★ **Instant visible rack identification**  
Choose either magnetic or self-adhesive
- ★ **Easy to insert & update**  
Simple pull forward panel
- ★ **Suitable for many applications**  
Magnetic holders are ideal for cold stores
- ★ **Many sizes available from stock**  
Pre-cut lengths for quick despatch



## Magnetic Location Markers and Location Strips

White magnetic location markers in pre-cut sizes or strips on 10 metre rolls which allow easy positioning and relocating. Simply use a wet-wipe marker pen to write on or update providing a quick and easy high visible system of identifying locations.



### Key Features & Benefits



- ★ **Sticks to steel surface**
- ★ **Simply – Write On and Wipe Off**
- ★ **Quick and Easy positioning**
- ★ **Pre-cut lengths or rolls**
- ★ **Cost effective and fast**

#### Magnetic Easy Wipe Location Strips (white)

Size (mm) H x W	Code	Pack	Price
20 x 10	MSR2W	10 metre	£21.60
30 x 10	MSR3W	10 metre	£29.10
50 x 10	MSR5W	10 metre	£44.70
70 x 10	MSR7W	10 metre	£52.20
Black dry wipe pen	PB/5	5	£9.81

Other colours and sizes to order

#### Magnetic Easy Wipe Location Markers (white)

Size (mm) H x W	Code	Pack	Price
20 x 80	LM28W	100	£20.85
30 x 80	LM38W	100	£27.00
40 x 80	LM48W	100	£31.35
50 x 80	LM58W	100	£39.90
Black dry wipe pen	PB/5	5	£9.81

## Racksack - Warehouse Recycling Sacks

Waste management problems are easily solved with the racksack. The racksack is designed for most racking and shelving systems between 900mm and 1100mm. Once full, racksacks can be removed and emptied with ease. When hung it has a large open mouth to easily receive waste, yet its tapered design enables it to hardly encroach into the floor area. Originally designed for the warehouse the racksack's flexible method of 'S' locator fixing means it can be hung over or hooked onto any substrate making it ideal in other industrial areas such as factories, offices or anywhere where waste has become a problem.

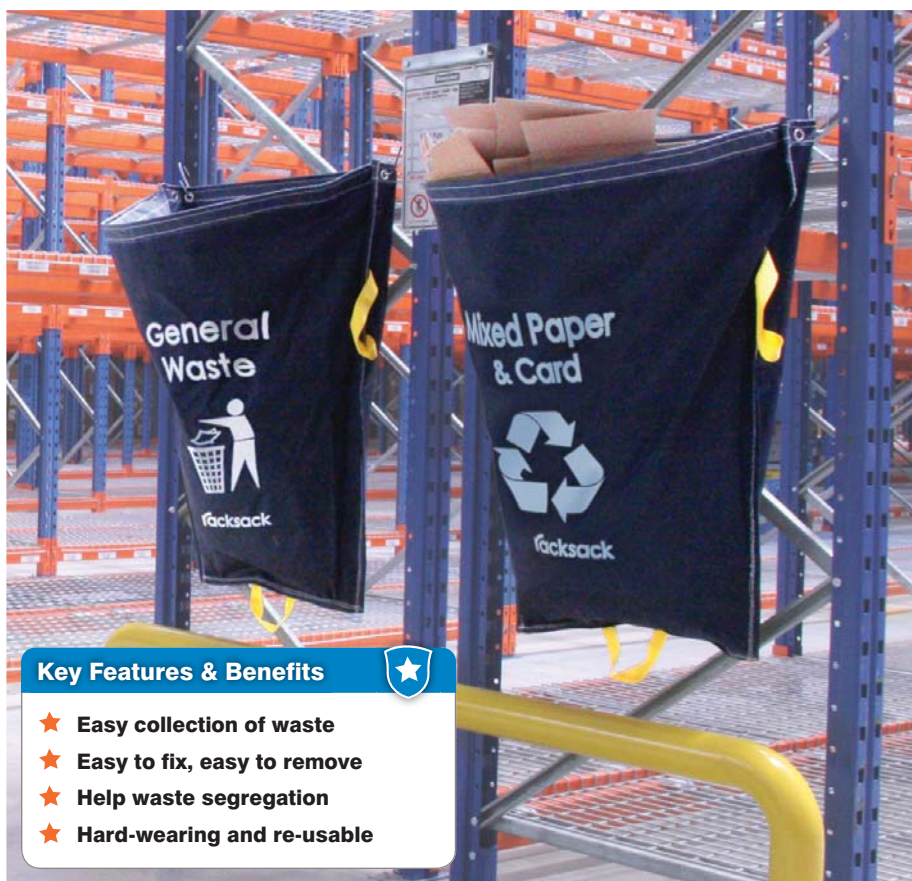

### Key Features & Benefits

- ★ **Easy collection of waste**
- ★ **Easy to fix, easy to remove**
- ★ **Help waste segregation**
- ★ **Hard-wearing and re-usable**

#### Rack Sack

Type	Code	Pack	Price
General Waste	RSB/GW	1	£20.40
Mixed Paper and Card	RSB/MP	1	£20.40
Cardboard	RSB/C	1	£20.40
Plastic Only	RSB/P	1	£20.40
Plastic Strapping	RSB/PS	1	£20.40
Shrink wrap	RSB/SW	1	£20.40
Mixed Recycling	RSB/MR	1	£20.40
Metal	RSB/M	1	£20.40
Aluminium	RSB/A	1	£20.40
Wood & Timber	RSB/WT	1	£20.40
Building Material	RSB/BM	1	£20.40
Electrical	RSB/E	1	£20.40
Glass	RSB/GL	1	£20.40
Blank	RSB/BK	1	£20.40



## Troax Boxes

Mini and Maxi Boxes provide a secure storage solution for both indoor and outdoor use. Troax Boxes are suitable for safely storing gas bottles, hazardous materials, and valuable plant machinery.

Maxi Boxes are available in 5 standard sizes but can be modified to suit your specific application. All Boxes come with a pad-lockable single or double door with a mesh roof as standard. Fixings supplied. Expamet (Expanded Metal) options are available.

Mesh aperture: 50 x 50mm

High quality powder coated finish is available in Grey RAL 7037 as standard. Other colours available upon request. Hot-dip galvanised finish for outdoor use.

Shelving is available for Mini Boxes (P.O.A.)

### Key Features & Benefits

- ★ **Create secure areas with no fuss or hassle**
- ★ **High quality finish in powder coated in grey RAL7037**
- ★ **Wide range of sizes to meet your requirements**
- ★ **Secure mesh panels - 50 x 50mm aperture**
- ★ **Doors come with facility to fit a padlock (padlock not supplied)**



### Troax Boxes

Description	Size H x W x D	Price
UX Mini Box	2230mm x 1200mm x 1200mm	£701.88
UX Maxi Box #1	2230mm x 2200mm x 1200mm	£872.03
UX Maxi Box #2	2230mm x 1200mm x 2400mm	£1142.72
UX Maxi Box #3	2230mm x 1200mm x 3600mm	£1473.46
UX Maxi Box #4	2230mm x 1200mm x 4800mm	£1744.15
UX Maxi Box #5	2230mm x 1200mm x 6000mm	£2014.83

Above prices include pad-lockable door assembly, exclusive of padlock. Additional locking options are available upon request. Hot Dipped Galvanized prices are available upon request.



### Have you seen...



Rivet racking p.8 - 23



## Troax Caelum Modular Mesh Partitioning

Caelum is a flexible system that can be used to build enclosures, boxes, storage units, and provide protection in automated warehouses.

It is particularly useful in bonded stores, low-level and semi-secure storage areas, and as small cage enclosures where high value retail goods (i.e. Smart phones, mobile telephones, tablets, laptops, computers, power tools, liquor, tobacco, etc.) are stored. A variety of additional features such as digital locks (pricing available upon application) provide increased security for high-value goods areas.

Caelum is available in multi-tiered elevations, enabling the end user to partition off large secure storage areas within warehouse environments, particularly useful for isolating and storing dangerous goods such as aerosols or combustible materials.

The Caelum Mesh Wall system is available in a variety of powder-coated finishes, or hot dip galvanised (for outdoor use).

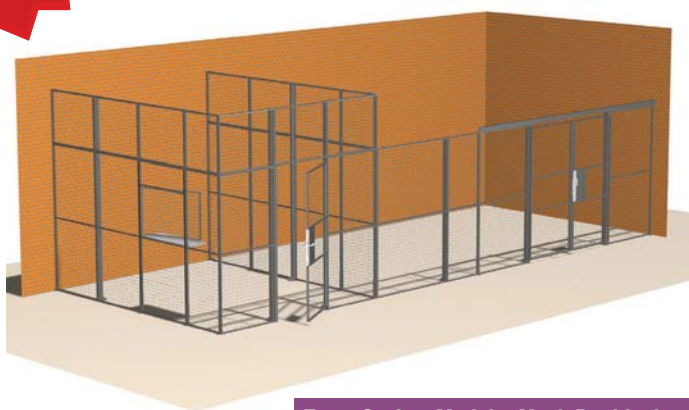

**Troax Caelum Modular Mesh Partitioning**

Height	Price
@ 2200mm High	£95.00 per Linear Metre
@3000mm High	£150.00 per Linear Metre

*Single Hinged Door*

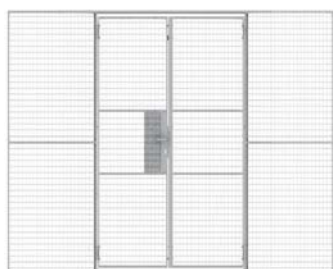

*Double Hinged Door*

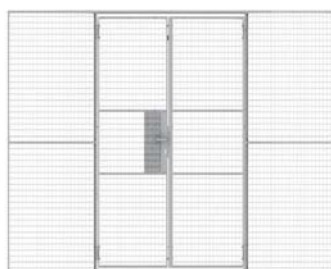

*Single Sliding Door*



*Double Sliding Door*

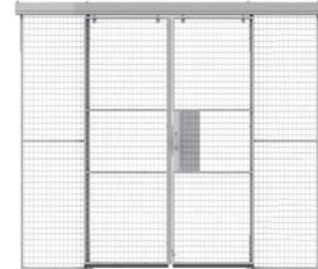

# Great Value Products for 2014



Clicka 175

pages 4 – 5

Bins in Cupboards

pages 94 – 95



New Euro Containers

page 99



**FREE** 5 Day Delivery  
**FREE** Technical Advice  
**NEW** Products  
**100s** of Storage Ideas

**...see more inside**



## Bay Shelving

Storage Solutions

- Great storage products backed up with great service
  - Measuring service available
  - Fitting service available
- Discounts for large quantities
  - Free technical advice

Tel: 01745 570 348

Email: [info@bayshelving.co.uk](mailto:info@bayshelving.co.uk) Website: [www.bayshelving.co.uk](http://www.bayshelving.co.uk)