



LIQUID HANDLING TECHNOLOGY

*Products for  
the Laboratory  
2013*

Pipette Tips. Robotic Tips.  
Pipettes. Pipette Servicing.  
Consumables. Sample Storage.  
Equipment. Protection



**Customer Account No:**

--	--	--	--	--

**Your STARLAB Account Manager:**

**STARLAB (UK), Ltd**

**Tel: 01908 283800**

**Fax: 01908 283802**

**infoline@starlab.co.uk**

© March 2013 web.v1. All rights reserved. Every effort has been made to ensure the content of this publication is correct. STARLAB can not take responsibility for any errors or omissions. All prices exclude VAT.

ErgoOne, CytoOne, PlateOne, RepeatOne and STARLAB are registered Trademarks and owned by STARLAB Group. Connect-A-Rack, MiniFuge, StarChill, StarFile, StarFolder, StarPet, StarPet Pro, StarPet E, StarPet Filler, StarRack, StarSeal, StarStack, StarStore, StarTags, StarTub, Rotator Mixer, Single & Dual Blocksystem, Vortex Wizard with Infrared, Ultra Flat Magnetic Stirrer, TipOne repeat and TwisStar are Trademarks of **STARLAB Group**.

Trademarks or registered Trademarks of other manufacturers or distributors are acknowledged as the property of their respective owners. Trademarks as mentioned in this publication include:

AirClean is a registered Trademark of **AirClean Systems**. Aurora Biomed Versa is a Trademark of **Aurora Biomed**. Biohit is a registered Trademark of **Biohit Oy**. Beckman Coulter, Beckman Biomek 1000, Beckman Biomek 2000, Beckman Biomek 3000, Beckman Biomek FX, Beckman Biomek NX, Beckman and Multimek are Trademarks of **Beckman Coulter**. Biotek is a Trademark of **Biotek Instruments**. BMP21, LabPal and LabXpert are Trademarks of **Brady**. Brand and Brand HandyStep are Trademarks of **BRAND**. Caliper and RapidPlate are Trademarks of **Caliper Instruments**. CAPP and CappOrigami are Trademarks of **CAPP, DK**. Corning and Costar are Trademarks of **Corning Inc.** Distel is a Trademark of **Tristel**. Dynamic Devices Oasis LM is a Trademark of **Dynamic Devices**. Eppendorf and Multipette are registered Trademarks of **Eppendorf AG**. Cyberlab, Distriman and Gilson are Trademarks of **Gilson Instruments**. Hamilton and MicroLab Star, Precision, STARlet and STARPLUS are Trademarks of **Hamilton**. SmartSpatula is a Trademark of **Heathrow Scientific**. DermaFree, Diamond Grip Plus, UltraSense, UltraSense Plus, FreeForm SE, Supreno, Supreno Plus, NeoPro, Synetron Plus and Xceed are Trademarks of **Microflex**. MLA is a Trademark of **MLA**. Parafilm is a Trademark of **American National Can Company**. Nichiryo is a Trademark of **Nichiryo**. Oxford-Benchmate is a Trademark of **Oxford Group**. Perkin Elmer Evolution P3, Perkin Elmer Janus, Perkin Elmer MiniTrak, Perkin Elmer MultiProbe, Packard, PlateTrak and Perkin Elmer are Trademarks of **Perkin Elmer**. CAS-4200, Colibra, Corbett, Qiagen, Qiagility and Rotor-Gene and Rosys Qiagen are Trademarks of **Qiagen**. Rainin LTS is a Trademark of **Rainin**. Ritter Pipette is a Trademark of **Ritter**. SciClone is a Trademark of **SciClone Pharmaceutical**. SMI is a Trademark of **SMI**. Socorex is a Trademark of **Socorex Instruments**. Zymark is a Trademark of **Sotax**. CyroSecure is a Trademark of **STARLAB, CH**. Aquarius, Freedom EVO, Tecan Freedom SE, Genesis and MiniPrep are Trademarks of **Tecan**. Finnpiquette, Fisherbrand, Labsystems and Matrix are Trademarks of **Thermo Fisher**. Titertek is a Trademark of **Titertek**. Volac is a Trademark of **Volac**.

PCR is a patented process of Roche Holdings.



# Contents

## PIPETTE TIPS

TipOne® Pipette Tip System.  
Specialty Tips.  
Dispenser Tips.

5 – 24



## ROBOTIC TIPS

Beckman Coulter®, Biotek®, Caliper®/Zymark®,  
Packard®/Perkin Elmer®, Qiagen®,  
Tecan®, Robotic Reservoirs.

25 – 38



## PIPETTES

Manual Pipettes.  
Electronic Pipettes.  
Pipette Controllers. Serological Pipettes.  
Repeat Dispenser.

39 – 48



## PIPETTE SERVICING

Calibration & Repair Service Overview.  
Standard Servicing. UKAS Servicing.  
Spares for ErgoOne® Pipettes.  
Spares for Gilson® Pipettes.

49 – 56



## CONSUMABLES

Tubes. PCR Consumables. Plates. Plate Sealing.  
Parafilm®, Autoclaving. Cuvettes.  
Reagent Reservoirs. Scrapers, Loops & Spreaders.  
Pasteur Pipettes. Spatulas & Weighboats. Labelling.

57 – 96



## SAMPLE STORAGE

Storage Boxes & Racks.  
Benchtop Coolers.  
Stainless Steel Storage. Freezer Racking.  
Slide Storage & Staining.

97 – 122



## EQUIPMENT

PCR Cabinets. Magnetic Stirrers.  
Orbital Shaker. Dry Bath Incubators.  
Vortex Mixers.  
Microcentrifuges.

123 – 132



## PROTECTION

Disposable Gloves.  
Laboratory Disinfectant.  
Benchtop Safety.  
Safe Disposal.

133 – 142



ALPHABETICAL INDEX 143–144  
INDEX BY CATALOGUE NUMBER 145–148

# STARLAB Quality & Service

## The STARLAB Group

The STARLAB Group specialises in the field of Liquid Handling Technology. In the UK, STARLAB's offices and extensive warehouse facilities are centrally located in Milton Keynes, allowing rapid distribution of products from stock. STARLAB is also based in Germany, France and Italy, and has a network of distributors selling its products throughout the world.



STARLAB's success is founded on its expertise in automated injection moulding processes for the manufacture of high quality laboratory consumables for research and development.

## STARLAB products

The STARLAB UK portfolio includes an extensive range of pipette tips and other consumables, as well as Caltech, the UKAS accredited Pipette Calibration and Repair Service.

STARLAB manufactured products are in daily use in laboratories throughout the world and have a proven track record of performance and reliability. Quality Control procedures are second to none, ensuring the highest possible levels of cleanliness, with all products certified RNase, DNase, DNA and Pyrogen free.



## The STARLAB promise

Quality, price and service are the principles on which the STARLAB Group is built. STARLAB is confident that you will find all our products to be of excellent quality and excellent value.

## An accredited organisation

STARLAB (UK) is an **ISO 9001** accredited company. Customers can be sure of a high quality service from order through delivery to after sales care.

STARLAB was the first UK company within its sector to be awarded the **ISO 14001** for environmental management. This accreditation not only covers the recycling collection service we offer our customers, it also covers the management of our daily impact on the environment and our commitment to lowering that impact by a 5% each year.



STARLAB's pipette calibration service is **UKAS** accredited so you can be sure that all our technicians are competent and fully-trained and our instruments are calibrated and properly maintained.

*"Our aim is to  
service the laboratory market  
with the very highest quality goods  
and unrivalled levels  
of service"*

# Investing in the Future



## Sustainable and progressive

STARLAB prides itself on being a 'Green' company from start to finish. We don't offer quick fixes or 'green gimmicks' to get a customer's attention, we believe in working on long-term strategies to reduce the company's impact on the environment.

As a manufacturer, STARLAB has control over the design and manufacture of its products. Our green ideas start at the design stage and our research and development teams are constantly looking at ways to more efficiently manufacture greener products. As a young, innovative company STARLAB has become a green leader in its field, setting the environmental standard for others to follow.

## GREEN design

- TipOne® is the original, reusable, refillable and recyclable pipette tip system
- Pack and case dimensions are designed to fit efficiently on a pallet to help save shipping costs
- Packaging is made from recycled, recyclable cardboard
- Continual review of product line with a view to reduce plastic use whenever new moulds are required, eg, the plastic on the 200µl refill trays was recently reduced by 38%
- Keeping up with new trends and innovations: thinner pipette tips may be challenging to manufacture but they provide a better tip fit and use less plastic

## GREEN manufacturing

- Hot runner moulds to save on plastic usage
- Closed-water-cycle cooling processes save energy
- The use of modern, hybrid moulding machines consume much less energy than the older, hydraulic machines
- The use of multi-cavity moulds to consume less energy
- A third of the factory's energy is sourced from wind power

## GREEN company

- First UK company within its sector to be awarded ISO 14001 accreditation for Environmental Management
- Constantly monitors and improves environmental management (5% improvement year on year)
- Commitment to reduce the impact of the business on the local area and the environment as a whole

## GREEN practices

- Reducing, reusing and recycling stationery and warehouse packing materials
- Recycling kitchen waste
- Reducing power usage and lowering carbon emissions

**STARLAB UK IS  
ZERO LANDFILL!**

## GREEN leader

- First company in UK to offer its customers an easy and regular recycling service for plastic laboratory waste
- A choice of recycling methods to suit individual customer's needs
- STARLAB is committed to recycling laboratory waste and continually monitors the service in order to improve it both for the convenience of its customers and for the benefit of the environment

## GREEN champion

- STARLAB was awarded Green Champion status in the 2006 Green Apple Awards for Environmental Best Practice for our pioneering recycling collection scheme
- This award recognises STARLAB as one of the country's leaders in setting environmental standards for others to follow
- A second Green Apple Award for logistics was received in 2011



## What's New?

### What's new from STARLAB?

Look out for the **New!** logo throughout the catalogue.  
Below are just some of the exciting new products for 2013...



#### **New!** 300µl TipOne® tips

300µl TipOne® pipette tip with precision point and thin wall. A longer tip for easier access into tubes. Filtered version available too! See pages 12–17.

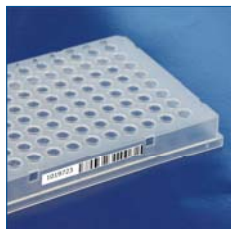

#### **New!** PCR Consumables

New PCR products include strip tube and cap combination packs, low-profile strips and barcoded PCR Plates. See pages 68–75.



#### **New!** Expanding work-storage rack

Innovative new rack which expands to give room for sample handling on the bench, and can then be closed again for storage in the freezer. See page 105.



#### **New!** Wider range of freezer racking

We have expanded our range of freezer racking for both upright and chest freezers, and the range now includes economical aluminium racking. See pages 114–119.



#### **New!** Plate microcentrifuge

A compact and economical microcentrifuge for quick spin downs on your bench. Holds two plates. See page 131.



# *Pipette Tips*

## **TipOne® PIPETTE TIP SYSTEM**

Ten Reasons to Use TipOne® Tips .....	6–7
An Excellent Tip Deserves an Excellent System .....	8–9
The TipOne® Life Cycle .....	10
TipOne® Recycling .....	11
TipOne® Ordering Info .....	12–13
TipOne® Filter Tip Ordering Info .....	14–15
TipOne® RPT Ordering Info .....	16–17

## **SPECIALTY TIPS**

300µl Filter Tips .....	18
384-Format Tips .....	18
Extended Length Tips .....	19
Large Volume Tips .....	20–21
Wide Orifice Tips .....	22
Gel Extraction Tool .....	22
Gel-Loading Tips .....	23

## **DISPENSER TIPS**

TipOne® Repeat Dispenser Tips .....	24
-------------------------------------	----

# Ten Reasons to Use TipOne® Tips



# TipOne

## 1. Excellent MATERIAL

All TipOne® tips are manufactured from pure, virgin polypropylene to ensure the highest quality product. We only use approved raw materials from audited and validated suppliers.

## 2. Excellent MANUFACTURE

The use of multiple cavity tools for the injection moulding process guarantees high conformity within one batch. The automated moulding and assembling procedures are carried out under clean-room conditions to eliminate contamination.

## 3. Excellent QUALITY CONTROL

Automated Quality Control procedures ensure that TipOne® is inspected for 100% performance. Regular inspections of tip geometry, tip fit and packaging are carried out during production.

## 4. Excellent CLEANLINESS

All TipOne® tips are certified RNase, DNase, DNA and Pyrogen free. Sterile options are available and all filter tips are supplied pre-sterilised. TipOne® is sterilised in accordance with **EN ISO 11137-2: 2007**. Certification parameters for RNase, DNase, DNA and Pyrogens are checked at set intervals by an independent testing institution.

## 5. Excellent SAVINGS

We recommend not autoclaving. The easy to use refill design means the tips do not touch the side of the rack as they are inserted and neither will your fingers touch the tips. Therefore, refill tips are still certified once racked so there is no need to autoclave. Saves time, saves energy, saves money!



## New, 300µl TipOne® Tips!

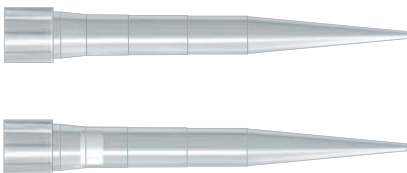

New, 300µl filtered and non-filter TipOne® pipette tips with a precision point and thin wall. A longer tip for easier access into tubes. Filtered version available too!



TipOne

**6. Excellent TIP**

One tip fits all! The tip cone is engineered to fit all popular pipettes, thus eliminating the clutter of different types of tip rack on your bench. The highest quality production methods and Quality Control guarantees the highest quality product for the highest quality results. An excellent tip, from top to bottom!



**7. Excellent FILTER**

The filter in TipOne® Filter Tips protects against aerosol cross-contamination without trapping your valuable samples. STARLAB's ultra high-density filters are proven\* to block >99% of aerosol contaminants. The filters contain no additives that interfere with samples. All filter tips are provided sterile in individually wrapped racks.

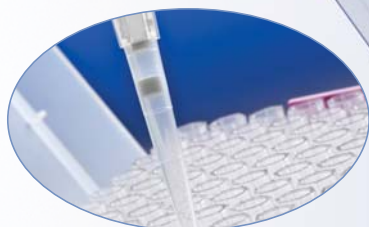

**8. Excellent GRADUATIONS**

For visual identification of the correct volume of aspirated liquid

**9. Excellent HIGHLY POLISHED MOULDS**

Reduced sample retention

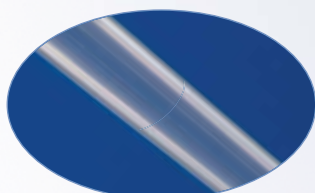

**10. Excellent FLASH-FREE ORIFICE**

Prevents sample hold up

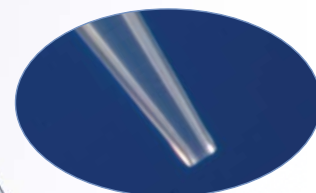

\*See page 14.

# An Excellent Tip Deserves an Excellent System

## Sophisticated

TipOne® is the original reusable, refillable and recyclable pipette tip system. The system is designed to be easy to use, to reduce waste and to save costs for the user.

The TipOne® rack is extremely durable. It can be refilled over and over again and will withstand repeated autoclaving while retaining its stability, strength and shape.

There are five packaging options to cover individual pipetting needs, all designed down to the smallest detail for your convenience.

We recommend not autoclaving. All TipOne® tips are certified RNase, DNase, DNA and Pyrogen free. Sterile options of all TipOne® tips are available if sterility is key. The easy to use refill design means the tips do not touch the side of the rack as they are inserted, nor will your fingers touch the tips! So refills are still certified once racked, meaning there's no need to autoclave.



## Stack Rack

- Wide base for great stability – even with multi-channel use
- 960 tips for high throughput
- Lid keeps tips safe when not in use
- Autoclavable
- Recyclable



## Loose

- Ideal for teaching labs or non-critical work
- Tamper-proof, easy-open perforation strip on bag
- Bag has resealable zip-lock
- Recyclable polyethylene bag

## How does the Stack Rack work?



960 tips in the palm of your hand. Small footprint saves valuable bench space. Use straight from the Stack.

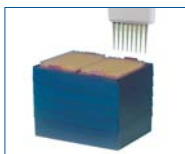

Wide base for excellent stability, even with multi-channel use. The inter-locked layers will not lift or loosen during use.



Remove each layer once you have used the tips to reveal the new layer of tips beneath.



Replace the lid when not in use to keep your tips clean, tidy and safe.



Both the purple tip wafers and the outer blue casing (layers) can be recycled.



### Single Refill

- Smaller refill consisting of five 96-tip wafers and one rack
- Ideal for your introduction to TipOne® or for low demand users
- Recyclable

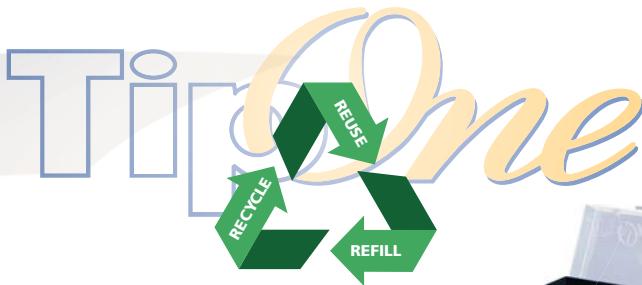
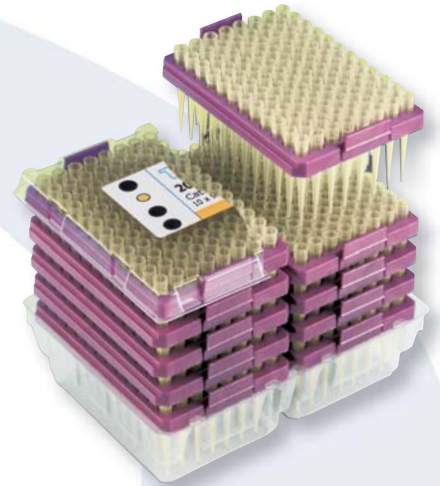

*The original reusable, refillable and recyclable system*



### Refill

- Economical and space saving
- Easy to load and easy to remove
- Fits perfectly in the rack – no 96 tip-hole alignment required!
- Reduces waste
- Autoclavable when racked
- Recyclable



### Racked

- Sturdy rack made from strong, high quality polypropylene
- Hinged transparent lid
- Stackable
- Reusable
- Withstands repeated autoclaving without warping
- Recyclable

### Easy open sterile packaging

TipOne® racked sterile and sterile Stack Racks with improved shrink wrapping! The new, easy-to-open design combines sterile safety with the convenience of fast access to your tips.



# The TipOne® Life Cycle

TipOne® Pipette Tip System



## Products manufactured from recycled TipOne® plastic

STARLAB has started manufacturing products using the polypropylene (PP) recycled from TipOne® products. First, we had some paint trays made from PP recycled from the purple refill wafers, and buckets from the PP from the blue racks.

STARLAB is now starting to manufacture products made from PP recycled from our TipOne® system specifically for use in the laboratory – such as sample storage boxes (pictured left). We hope to introduce a range of products soon!

# TipOne® Recycling

## It's easy to recycle with STARLAB!

- **No need to peel off the labels!**

The labels on our racks are recyclable. The only thing we do ask is that you remove any autoclave tape

- **No need to separate different plastics!**

The polypropylene racks/wafers and clear PET refill trays will be separated at the recycling factory

- **Convenient!**

We will set up a collection service to suit your individual lab or site-wide requirements. We can either arrange a regular recycling collection (eg. monthly) or can collect on an ad-hoc basis as and when you let us know you have enough recycling for collection

## Be as GREEN as possible!

Please collect as much recycling as space allows before requesting a collection. This will cut down the number of truck journeys and save on emissions.



## Reuse LARGE cardboard boxes for recycling!

Possibly the greenest way to send in recycling is to reuse a large box you already have. Please use the largest box possible!

Contact your area Account Manager, or the office on 01908 283800 or at [recycling@starlab.co.uk](mailto:recycling@starlab.co.uk) to set up recycling collections from your institution.

## A range of containers is available for collecting your recycling:



### Recycling crate

Ideal for use in/outside stores. Please note that easy truck access at your site is essential.

Dimensions (WxDxH): 120 x 100 x 94cm

Contact STARLAB to arrange



### Wheelie bin (240 litre)

Supplied with our heavy-duty recycling bags for lining the bin. Once full, simply remove the liner, secure with a nylon cable tie (also supplied) and the recycling is collected in the bag.

Bin dimensions (WxDxH): 56 x 74 x 94cm

**Cat. No. S5000-7300**



### Recycling bins

Smaller recycling containers to keep in the corner of your lab or under the bench.

#### Cardboard recycling bin, Cat. No. S5000-7600

Dimensions (WxDxH): 30.5 x 30.5 x 75cm

#### Green pop-up recycling bin, Cat. No. S5000-7000

Dimensions (HxØ): 60 x 50cm



### The STARLAB Recycling Bag

Clear, heavy-duty recycling bags for use in the wheelie bin, the pop-up bin or the cardboard bin. Made from recycled and recyclable material. Supplied with heavy duty nylon cable ties to secure contents.

**Cat. No. S5000-7100**















**LARGE Bag** to fit wheelie bin

**Cat. No. S5000-7200**

**SMALL Bag** to fit the pop-up and cardboard recycling bins. Can also be used on its own.



TipOne® Pipette Tip System

Pipette Tips	Loose	Racked	Racked (Sterile)
Pack Size:	1000 / Bag	10 x 96-Tip Racks	10 x 96-Tip Sterile Racks
 <b>10µl Graduated Tip</b> (Graduations: 2.5µl, 10µl)	<b>S1111-3000</b> £19.53 <b>S1111-3000-C</b> (120)	<b>S1111-3800</b> £30.98 <b>S1111-3800-C</b> (21)	<b>S1111-3810</b> £36.75 <b>S1111-3810-C</b> (8)
 <b>10µl XL Graduated Tip</b> , Max. Vol. 20µl (Graduations: 2µl, 5µl, 10µl)	<b>S1110-3000</b> £19.53 <b>S1110-3000-C</b> (110)	<b>S1110-3800</b> £30.98 <b>S1110-3800-C</b> (21)	<b>S1110-3810</b> £36.75 <b>S1110-3810-C</b> (8)
 <b>20µl Micro Tip</b> (Eppendorf-Style)	<b>S1111-4000</b> £19.53 <b>S1111-4000-C</b> (100)	<b>S1111-4800</b> £30.98 <b>S1111-4800-C</b> (21)	<b>S1111-4810</b> £36.75 <b>S1111-4810-C</b> (8)
 <b>200µl Tip</b>	<b>S1111-0000</b> £18.38 <b>S1111-0000-C</b> (48)	<b>S1111-0800</b> £29.82 <b>S1111-0800-C</b> (21)	<b>S1111-0810</b> £35.60 <b>S1111-0810-C</b> (8)
 <b>200µl Yellow Tip</b>	<b>S1111-0006</b> £18.38 <b>S1111-0006-C</b> (48)	<b>S1111-0806</b> £29.82 <b>S1111-0806-C</b> (21)	<b>S1111-0816</b> £35.60 <b>S1111-0816-C</b> (8)
 <b>200µl Bevelled Tip</b>	<b>S1111-1000</b> £18.38 <b>S1111-1000-C</b> (48)	<b>S1111-1800</b> £29.82 <b>S1111-1800-C</b> (21)	<b>S1111-1810</b> £35.60 <b>S1111-1810-C</b> (8)
 <b>200µl Yellow, Bevelled Tip</b>	<b>S1111-1006</b> £18.38 <b>S1111-1006-C</b> (48)	<b>S1111-1806</b> £29.82 <b>S1111-1806-C</b> (21)	<b>S1111-1816</b> £35.60 <b>S1111-1816-C</b> (8)
 <b>200µl Bevelled, Graduated Tip</b> (Graduations: 10µl, 50µl, 100µl)	<b>S1110-1000</b> £18.38 <b>S1110-1000-C</b> (48)	<b>S1110-1800</b> £29.82 <b>S1110-1800-C</b> (21)	<b>S1110-1810</b> £35.60 <b>S1110-1810-C</b> (8)
 <b>200µl Yellow, Bevelled, Graduated Tip</b> (Graduations: 10µl, 50µl, 100µl)	<b>S1110-1006</b> £18.38 <b>S1110-1006-C</b> (48)	<b>S1110-1806</b> £29.82 <b>S1110-1806-C</b> (21)	<b>S1110-1816</b> £35.60 <b>S1110-1816-C</b> (8)
 <b>300µl Graduated Tip</b> (Graduations: 50µl, 100µl, 200µl)	<b>S1110-8000</b> £20.16 <b>S1110-8000-C</b> (48)	<b>S1110-8800</b> £32.87 <b>S1110-8800-C</b> (21)	<b>S1110-8810</b> £39.17 <b>S1110-8810-C</b> (8)
 <b>300µl Graduated Tip</b> (Graduations: 100µl, 200µl, 300µl) <i>New!</i>	<b>S1110-9000</b> £20.16 <b>S1110-9000-C</b> (48)	<b>S1110-9800</b> £32.87 <b>S1110-9800-C</b> (21)	<b>S1110-9810</b> £39.17 <b>S1110-9810-C</b> (8)
 <b>1000µl Graduated Tip</b> (Graduations: 250µl, 500µl, 1000µl)	<b>S1111-2020</b> £20.58 <b>S1111-2020-C</b> (20)	<b>S1111-2820</b> £32.03 <b>S1111-2820-C</b> (12)	<b>S1111-2830</b> £37.80 <b>S1111-2830-C</b> (6)
 <b>1000µl Blue Graduated Tip</b> (Graduations: 250µl, 500µl, 1000µl)	<b>S1111-2021</b> £20.58 <b>S1111-2021-C</b> (20)	<b>S1111-2821</b> £32.03 <b>S1111-2821-C</b> (12)	<b>S1111-2831</b> £37.80 <b>S1111-2831-C</b> (6)
 <b>1250µl XL Graduated Tip</b> (Graduations: 100µl, 250µl, 500µl, 1000µl)	<b>S1112-1020</b> £20.06 <b>S1112-1020-C</b> (8)	<b>S1112-1820</b> £36.75 <b>S1112-1820-C</b> (8)	<b>S1112-1830</b> £44.52 <b>S1112-1830-C</b> (4)



	Refill	Single Refill	Stack Rack	Stack Rack (Sterile)
	10 x 96-Tip Refills	5 x 96-Tip Refills	1 x 960-Tip Stack	1 x 960-Tip Sterile Stack
	<b>S1111-3700</b> £25.83 <b>S1111-3700-C</b> (18)	<b>S1111-3701</b> £12.92 <b>S1111-3701-C</b> (40)	<b>S1111-3200</b> £28.56 <b>S1111-3200-C</b> (10)	<b>S1111-3210</b> £33.39 <b>S1111-3210-C</b> (10)
	<b>S1110-3700</b> £25.83 <b>S1110-3700-C</b> (12)	n/a	n/a	n/a
	n/a	n/a	n/a	n/a
	<b>S1111-0700</b> £21.84 <b>S1111-0700-C</b> (18)	n/a	<b>S1111-0200</b> £25.20 <b>S1111-0200-C</b> (10)	<b>S1111-0210</b> £31.19 <b>S1111-0210-C</b> (10)
	<b>S1111-0706</b> £21.84 <b>S1111-0706-C</b> (18)	n/a	<b>S1111-0206</b> £25.20 <b>S1111-0206-C</b> (10)	n/a
	<b>S1111-1700</b> £21.84 <b>S1111-1700-C</b> (18)	<b>S1111-1701</b> £10.92 <b>S1111-1701-C</b> (40)	<b>S1111-1200</b> £25.20 <b>S1111-1200-C</b> (10)	<b>S1111-1210</b> £31.19 <b>S1111-1210-C</b> (10)
	<b>S1111-1706</b> £21.84 <b>S1111-1706-C</b> (18)	n/a	<b>S1111-1206</b> £25.20 <b>S1111-1206-C</b> (10)	n/a
	<b>S1110-1700</b> £21.84 <b>S1110-1700-C</b> (18)	n/a	<b>S1110-1200</b> £25.20 <b>S1110-1200-C</b> (10)	n/a
	n/a	n/a	<b>S1110-1206</b> £25.20 <b>S1110-1206-C</b> (10)	n/a
	<b>S1110-8700</b> £24.05 <b>S1110-8700-C</b> (12)	n/a	n/a	n/a
	<b>S1110-9700</b> £24.05 <b>S1110-9700-C</b> (12)	n/a	n/a	n/a
	<b>S1111-2720</b> £24.04 <b>S1111-2720-C</b> (9)	n/a	n/a	n/a
	<b>S1111-2721</b> £24.04 <b>S1111-2721-C</b> (9)	n/a	n/a	n/a
	<b>S1112-1720</b> £27.83 <b>S1112-1720-C</b> (4)	<b>S1112-1721</b> £13.97 <b>S1112-1721-C</b> (20)	n/a	n/a

All TipOne® tips are certified  
RNase, DNase, DNA  
and Pyrogen free

TipOne® tips are designed to fit all popular pipettes without any loss of accuracy or precision.

**Unlimited empty racks for use with the refills are available for FREE!**

(Use the S Codes below to order.)  
**S0000-0002:** Small racks for use with all refills up to and including 300µl.  
**S9999-0002:** Large racks for use with 1000µl & 1250µl refills.



TipOne® filter tips: pages 14–15

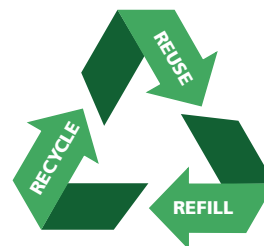

All tips shown actual size. n/a = not available.

**CASE SIZES available at discount!**  
Cat. Nos ending in -C are for case sizes. The number in brackets is the number of packs per case.

## TipOne® Filter Tips



### Nothing goes through!

Protect your samples against unwanted contamination by using TipOne® filter tips.

During pipetting it is not possible to see with the eye if fine aerosols are going into your pipette. If they are, those aerosols can contaminate other samples at a later date.



TipOne® filter tips are proven to block >99% of aerosols and are among the best filters on the market. The results, shown right, speak for themselves!

### Why use TipOne® filter tips?

**Quality!** TipOne® filters are made from high density pure polyethylene (HDPE).

**Safety!** They contain no additives which can interfere with your samples.

**Retrieval!** TipOne® filters are hydrophobic and will not absorb your samples the way sealing filters do, allowing recovery of your valuable samples if necessary.

**One tip fits all!** TipOne® tips are designed to fit all popular pipettes without any loss of accuracy or precision.

**Reuse the filter tip rack** with the refills (see page 13) for economical, racked non-filter tips.

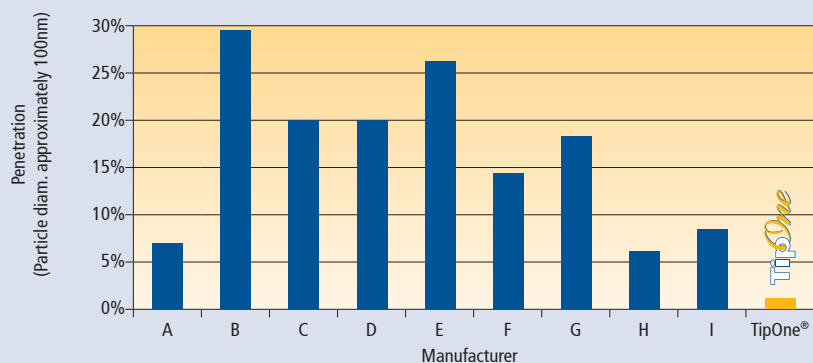

### Aerosol transmission of TipOne® filter tips compared to other manufacturers' filter tips



\* The comparative tests were conducted in an independent test institute with filters from other leading manufacturers.



# TipOne® Filter Tips

Filter Tips	Racked (Sterile)
Pack Size: 10 x 96-Tip Sterile Racks	
 <b>10µl Graduated Filter Tip (Sterile)</b> (Graduations: 2.5µl, 10µl)	<b>S1121-3810</b> £64.16 <b>S1121-3810-C</b> (8)
 <b>10µl XL Graduated Filter Tip, Max. Vol. 20µl (Sterile)</b> (Graduations: 2µl, 5µl, 10µl)	<b>S1120-3810</b> £64.16 <b>S1120-3810-C</b> (8)
 <b>20µl Micro Filter Tip (Eppendorf-Style) (Sterile)</b>	<b>S1121-4810</b> £64.16 <b>S1121-4810-C</b> (8)
 <b>20µl Bevelled Filter Tip (Sterile)</b>	<b>S1120-1810</b> £60.80 <b>S1120-1810-C</b> (8)
 <b>50µl Bevelled Filter Tip (Sterile)</b>	<b>S1120-2810</b> £60.80 <b>S1120-2810-C</b> (8)
 <b>100µl Bevelled Filter Tip (Sterile)</b>	<b>S1120-1840</b> £60.80 <b>S1120-1840-C</b> (8)
 <b>200µl Graduated Filter Tip (Sterile)</b> (Graduations: 50µl, 100µl, 200µl)	<b>S1120-8810</b> £60.80 <b>S1120-8810-C</b> (8)
 <b>300µl Graduated Filter Tip (Sterile)</b> (Graduations: 100µl, 200µl, 300µl) <i>New!</i>	<b>S1120-9810</b> £64.16 <b>S1120-9810-C</b> (8)
 <b>1000µl XL Graduated Filter Tip (Sterile)</b> (Graduations: 100µl, 250µl, 500µl, 1000µl)	<b>S1122-1830</b> £64.16 <b>S1122-1830-C</b> (4)

All tips shown actual size.



# TipOne

*All TipOne® filter tips are sterile and certified RNase, DNase, DNA and Pyrogen free*

**CASE SIZES available at discount!**

Cat. Nos ending in -C are for case sizes. The number in brackets is the number of packs per case.

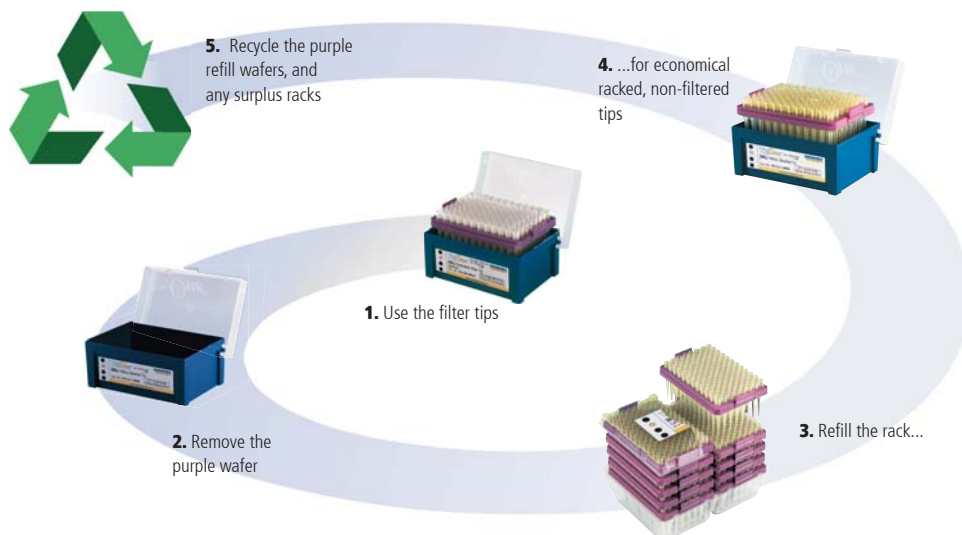

**FREE SAMPLE TRY before you BUY**  
available on request

# TipOne® RPT

Leading manufacturer's low retention tip with green food dye

TipOne® RPT with green food dye

## RPT: A technical breakthrough!

STARLAB's Repel Polymer Technology (RPT) optimises conventional polypropylene surfaces to improve the flow of 'sticky' liquids. STARLAB's TipOne® RPT tips have no coating to interfere with your sample and offer an extremely hydrophobic surface.

## RTP Tip Features

- No coating! Made from 100% virgin polypropylene
- Improved sample recovery
- Reduced protein binding
- Autoclavable
- Fits all popular pipettes
- Reusable, refillable and recyclable system



TipOne® RPT tips are supplied in the same style packaging as our standard TipOne® tips. Therefore, the RPT refills can be used in the racks from the standard tips, and vice versa.

**FREE SAMPLE**  
**TRY**  
before you  
**BUY**  
available on request













*All TipOne® RPT tips are certified RNase, DNase, DNA and Pyrogen free*

## CASE SIZES available at discount!

Cat. Nos ending in -C are for case sizes. The number in brackets is the number of packs per case.

# TipOne RPT





Repel Polymer Technology		Racked	Racked (Sterile)	Refills
Pack Size:		10 x 96-Tip Racks	10 x 96-Tip Sterile Racks	10 x 96-Tip Refills
 <b>10µl RPT Graduated Tip</b> (Graduations: 2.5µl, 10µl)		n/a	n/a	<b>S1161-3700</b> £28.35 <b>S1161-3700-C</b> (18)
 <b>10µl RPT XL Graduated Tip, Max. Vol. 20µl</b> (Graduations: 2µl, 5µl, 10µl)	<b>Maximum Capacity 20µl</b>	<b>S1160-3800</b> £34.55 <b>S1160-3800-C</b> (21)	n/a	<b>S1160-3700</b> £28.35 <b>S1160-3700-C</b> (12)
 <b>200µl RPT Bevelled Tip</b>		<b>S1161-1800</b> £32.86 <b>S1161-1800-C</b> (21)	n/a	<b>S1161-1700</b> £23.94 <b>S1161-1700-C</b> (18)
 <b>300µl RPT Graduated Tip</b>	<b>New!</b>	<b>S1160-9800</b> £40.11 <b>S1160-9800-C</b> (21)	n/a	<b>S1160-9700</b> £30.66 <b>S1160-9700-C</b> (12)
 <b>1250µl RPT XL Graduated Tip</b> (Graduations: 100µl, 250µl, 500µl, 1000µl)		<b>S1161-1820</b> £40.11 <b>S1161-1820-C</b> (8)	n/a	<b>S1161-1720</b> £30.66 <b>S1161-1720-C</b> (4)
 <b>10µl RPT Graduated Filter Tip (Sterile)</b> (Graduations: 2.5µl, 10µl)		n/a	<b>S1181-3810</b> £70.14 <b>S1181-3810-C</b> (8)	n/a
 <b>10µl RPT XL Graduated Filter Tip, Max. Vol. 20µl (Sterile)</b> (Graduations: 2µl, 5µl, 10µl)	<b>Maximum Capacity 20µl</b>	n/a	<b>S1180-3810</b> £70.14 <b>S1180-3810-C</b> (8)	n/a
 <b>20µl RPT Bevelled Filter Tip (Sterile)</b>		n/a	<b>S1180-1810</b> £66.78 <b>S1180-1810-C</b> (8)	n/a
 <b>100µl RPT Bevelled Filter Tip (Sterile)</b>		n/a	<b>S1180-1840</b> £66.78 <b>S1180-1840-C</b> (8)	n/a
 <b>200µl RPT Graduated Filter Tip (Sterile)</b> (Graduations: 50µl, 100µl, 200µl)		n/a	<b>S1180-8810</b> £66.78 <b>S1180-8810-C</b> (8)	n/a
 <b>300µl Graduated Filter Tip (Sterile)</b> (Graduations: 100µl, 200µl, 300µl)	<b>New!</b>	n/a	<b>S1180-9810</b> £70.14 <b>S1180-9810-C</b> (8)	n/a
 <b>1000µl RPT XL Graduated Filter Tip (Sterile)</b> (Graduations: 100µl, 250µl, 500µl, 1000µl)		n/a	<b>S1182-1830</b> £70.14 <b>S1182-1830-C</b> (4)	n/a



All tips shown actual size. n/a = not available.

**Free empty racks are available for use with refills – see page 13 for ordering details**

## 300µl Filter Tips

300µl Filter Tips					
All tips are certified and natural in colour.	Cat. No.	Pack Type	Sterile	Pack Size	Price
 <p><b>300µl Filter Tip (Sterile)</b> For use with: ErgoOne®, Biohit®, CAPP®, Discovery Comfort®, Eppendorf®, Finnpipette®, Gilson®, Rainin®, StarPet</p>	I1015-6810	96-Tip Rack	Yes	10 x 96	£64.16
	I1015-6810-C	96-Tip Rack	Yes	5 x 10x96	£320.57
 <p><b>300µl Filter Tip (Sterile)</b> For use with: Biohit®, CAPP®, Discovery Comfort®, Eppendorf®, Finnpipette®, Gilson®, Rainin®, StarPet</p>	E1130-8810	96-Tip Rack	Yes	10 x 96	£68.99
	E1130-8810-C	96-Tip Rack	Yes	5 x 10x96	£344.93

## 384-Format Tips







384-Format Tips					
Certified RNase, DNase and Endotoxin free. All tips natural in colour.	Cat. No.	Pack Type	Sterile	Pack Size	Price
 <p><b>30µl CAPP-Style 384-Format Tip</b> For use with but not limited to: CAPP® 16- 34- &amp; 64-Channel</p>	E3840-3000	384-Tip Rack	No	10 x 384	£411.81
	E3840-3010	384-Tip Rack	Yes	10 x 384	£456.33
 <p><b>60µl CAPP-Style 384-Format Tip</b> For use with but not limited to: CAPP® 16- 34- &amp; 64-Channel</p>	E3840-5000	384-Tip Rack	No	10 x 384	£439.64
	E3840-5010	384-Tip Rack	Yes	10 x 384	£489.72
 <p><b>50µl Finn-Style 384-Format Tip</b> For use with but not limited to: Finnpipette® Focus</p>	E3841-5000	384-Tip Rack	No	10 x 384	£328.34
	E3841-5010	384-Tip Rack	Yes	10 x 384	£356.16

### 384-Format Pipetting

See page 44  
for ordering  
details of  
the CAPP®  
16-, 48- and  
64-channel pipettes











# Extended Length Tips

Extended Length Tips						
All tips are certified and natural in colour.		Cat. No.	Pack Type	Sterile	Pack Size	Price
 <p><b>200µl XL Tip</b> For use with but not limited to: ErgoOne®, Gilson®, Biohit®, Costar®, Eppendorf®, Finnpiquette®, Nichiryo®, Oxford-Benchmate®, Rainin®, Socorex®, StarPet, Titertek®, Volac®</p>	E1011-0020	Bag	No	1000	£24.47	
	E1011-0920	204-Tip Rack	No	8 x 204	£87.89	
	E1011-0921	204-Tip Rack	Yes	8 x 204	£94.61	
 <p><b>200µl XL Filter Tip</b> For use with but not limited to: ErgoOne®, Gilson®, Biohit®, Costar®, Eppendorf®, Finnpiquette®, Nichiryo®, Oxford-Benchmate®, Rainin®, Socorex®, StarPet, Titertek®, Volac®</p>	E1011-0830	204-Tip Rack	Yes	8 x 204	£158.03	
	E1011-5830	100-Tip Rack	Yes	8 x 100	£77.91	
 <p><b>1000µl XL Bevelled Tip</b> For use with but not limited to: ErgoOne®, Gilson®, Biohit® (single-ch), Costar®, Eppendorf®, Finnpiquette®, Nichiryo®, Oxford-Benchmate®, Rainin®, Socorex®, StarPet, Titertek®, Volac®</p>	E1011-1002	Bag	No	1000	£18.90	
	E1011-1430	100-Tip Rack	No	10 x 100	£40.11	
	E1011-1420	100-Tip Rack	Yes	10 x 100	£42.00	
 <p><b>1000µl XL Bevelled Filter Tip</b> For use with but not limited to: ErgoOne®, Gilson®, Biohit® (single-ch), Costar®, Eppendorf®, Finnpiquette®, Nichiryo®, Oxford-Benchmate®, Rainin®, Socorex®, StarPet, Titertek®, Volac®</p>	E1011-1008	Bag	No	1000	£60.17	
	I1026-7800	100-Tip Rack	No	10 x 100	£84.00	
	I1026-7810	100-Tip Rack	Yes	10 x 100	£93.45	
 <p><b>1250µl XL Tip</b> For use with but not limited to: ErgoOne®, Gilson®, Biohit®, Costar®, Eppendorf®, Finnpiquette®, Nichiryo®, Oxford-Benchmate®, Rainin®, Socorex®, StarPet, StarPet E, Titertek®, Volac®</p>	E1011-3000	96-Tip Rack	Yes	8 x 96	£38.96	
	E1011-3010	96-Tip Rack	Yes	8 x 96	£71.23	
 <p><b>1250µl XL Filter Tip</b> For use with but not limited to: ErgoOne®, Gilson®, Biohit®, Costar®, Eppendorf®, Finnpiquette®, Nichiryo®, Oxford-Benchmate®, Rainin®, Socorex®, StarPet, StarPet E, Titertek®, Volac®</p>	E1011-3010	96-Tip Rack	Yes	8 x 96	£71.23	

FREE SAMPLE  
**TRY**  
 before you  
**BUY**  
 available on request

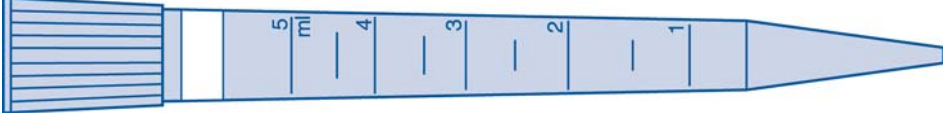
# Large Volume Tips

Large Volume Tips							
All tips are certified and natural in colour (unless stated otherwise).			Cat. No.	Pack Type	Sterile	Pack Size	Price
 <b>1200µl Biohit-Style Tip</b> For use with: Biohit® Proline	I1012-6400	96-Tip Rack	No	10 x 96	£42.11		
	I1012-6410	96-Tip Rack	Yes	10 x 96	£46.73		
 <b>1250µl Matrix-Style Tip</b> For use with: Matrix® Impact and Impact 2	E1250-0000	Bag	No	500	£23.42		
	E1250-0700	96-Tip Rack	No	12 x 96	£72.35		
	E1250-0710	96-Tip Rack	Yes	12 x 96	£89.04		
 <b>1250µl Matrix-Style Filter Tip</b> For use with: Matrix® Impact and Impact 2	E1250-0718	96-Tip Rack	Yes	12 x 96	£119.07		
 <b>2500µl Eppendorf-Style Tip</b> For use with: Eppendorf®, Socorex®	I1008-9000	Bag	No	500	£38.96		
 <b>5000µl Biohit-Style Tip</b> For use with: Biohit®, Eppendorf®, Genex®	E1009-7000	Bag	No	250	£20.06		
 <b>5000µl Biohit-Style XL Tip</b> For use with: Biohit®, Eppendorf®, Genex®	E1009-7001	Bag	No	250	£22.26		
 <b>5000µl Eppendorf-Style Graduated Macro Tip</b> For use with: Eppendorf®, Biohit®, Socorex®	I1053-0000	Bag	No	250	£13.13		
	I1053-0700	50-Tip Rack	No	10 x 50	£51.77		
	I1053-0710	50-Tip Rack	Yes	10 x 50	£57.86		
 <b>5000µl Eppendorf-Style Graduated Filter Macro Tip</b> For use with: Eppendorf®, Biohit®	I1053-0728	50-Tip Rack	Yes	2 x 50	£56.81		
 <b>5000µl Finn-Style Tip</b> For use with: Finnpipette®, Brand®, SMI®, Socorex®	E1009-5000*	Bag	No	250	£20.00		
	E1009-5700*	Racked	No	4 x 50	£88.00		
 <b>5000µl Finn-Style Filter Tip</b> For use with: Finnpipette®, Brand®, SMI®, Socorex®	E1009-5718	Racked	Yes	1 x 50	£37.00		





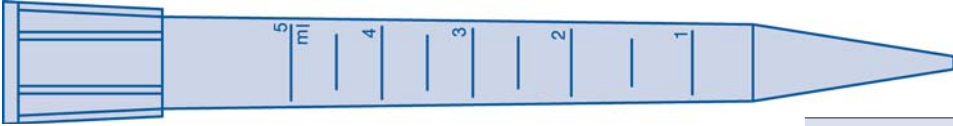
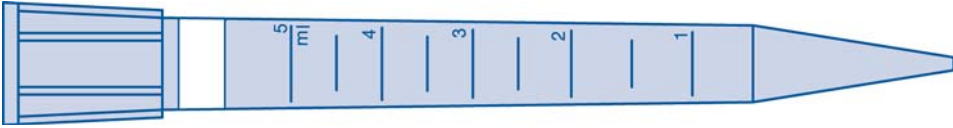
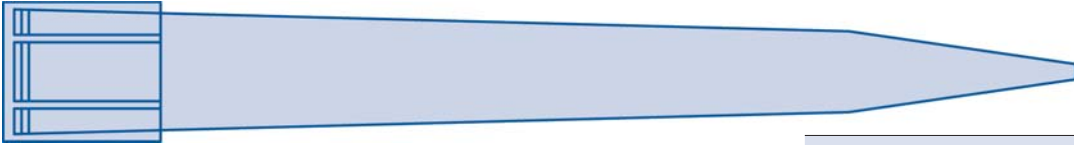
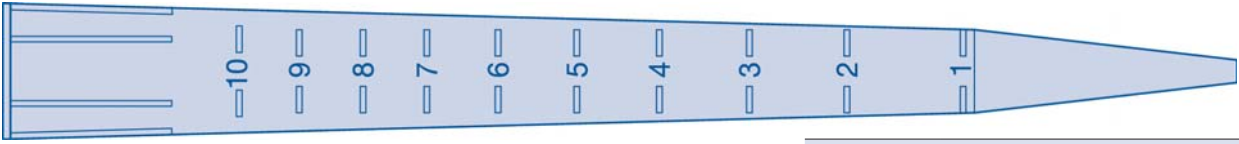
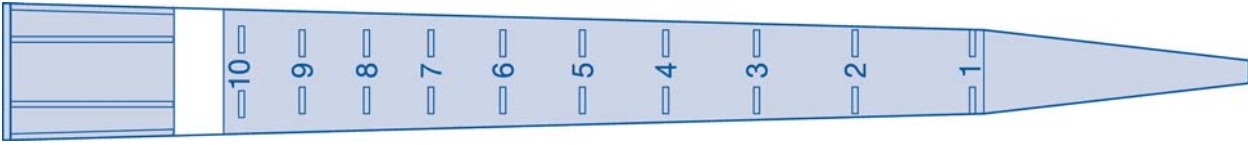
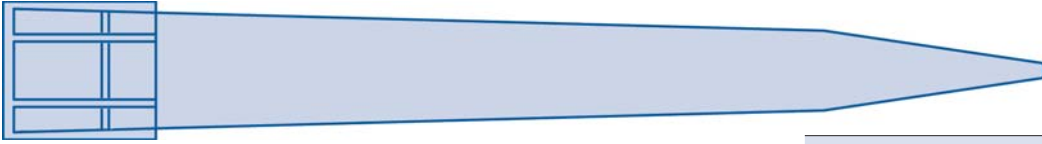
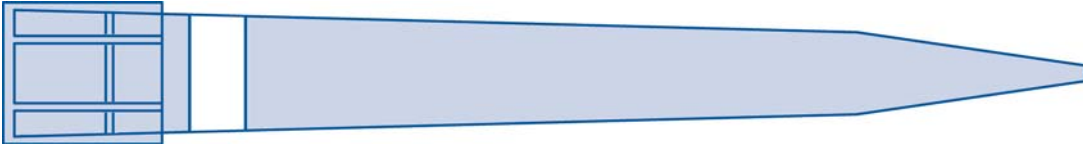

\*Not certified.

# Large Volume Tips

Large Volume Tips							
All tips are certified and natural in colour (unless stated otherwise).			Cat. No.	Pack Type	Sterile	Pack Size	Price
			11050-0000	Bag	No	250	£12.81
<b>5000µl Gilson-Style Graduated Macro Tip</b> For use with: ErgoOne®, Gilson®, Nichiryo®, StarPet, Volac®			11050-0700	50-Tip Rack	No	10 x 50	£51.24
			11050-0710	50-Tip Rack	Yes	10 x 50	£55.65
			11050-0728	50-Tip Rack	Yes	2 x 50	£49.56
<b>5000µl Gilson-Style Graduated Macro Filter Tip</b> For use with: ErgoOne®, Gilson®, Nichiryo®, StarPet, Volac®							
			11051-0000	Bag	No	200	£27.83
<b>10ml Gilson-Style Macro Tip</b> For use with: Gilson®, Eppendorf®, Rainin®, StarPet			11051-0350	25-Tip Rack	No	10 x 25	£72.35
			11051-0360	25-Tip Rack	Yes	10 x 25	£79.07
			11054-0000	Bag	No	200	£27.83
<b>10ml Gilson-Style Graduated Macro Tip</b> For use with: Gilson®, Eppendorf®, Rainin®, Socorex®, StarPet			11054-0001	25-Tip Rack	No	10 x 25	£66.78
			11054-0011	25-Tip Rack	Yes	10 x 25	£72.35
			11054-0028	25-Tip Rack	Yes	2 x 25	£44.52
<b>10ml Gilson-Style Graduated Macro Filter Tip</b> For use with: Gilson®, Eppendorf®, Rainin®, Socorex®, StarPet							
			11052-0000	Bag	No	200	£20.06
<b>10ml Finn/Socorex-Style Blue Tip</b> For use with: Finn®, Socorex®			11052-0001	25-Tip Rack	No	10 x 25	£50.09
			11052-0010	25-Tip Rack	Yes	10 x 25	£59.01
			11052-0028	25-Tip Rack	Yes	2 x 25	£44.52
<b>10ml Finn/Socorex-Style Blue Filter Tip (Working Vol. 9.5ml)</b> For use with: Finn®, Socorex®							

# Wide Orifice Tips

Specialty Tips

Wide Orifice Tips						
All tips are certified and natural in colour.		Cat. No.	Pack Type	Sterile	Pack Size	Price
						
<b>200µl Tip / Wide Orifice</b> For use with: ErgoOne®, Gilson®, Biohit®, Costar®, Eppendorf®, FinnpiPETTE®, MLA®, Nichiryo®, Oxford-Benchmate®, Rainin®, Socorex®, StarPet, StarPet E, Titertek®, Volac®		I1011-8000	Bag	No	1000	£17.85
		E1011-8000	Bag	No	1000	£18.90
		E1011-8400	96-Tip Rack	No	10 x 96	£30.03
<b>200µl Graduated Tip / Wide Orifice</b> For use with: ErgoOne®, Gilson®, Biohit®, Costar®, Eppendorf®, FinnpiPETTE®, Fisherbrand®, Nichiryo®, Oxford-Benchmate®, Rainin®, Socorex®, StarPet, StarPet E, Titertek®, Volac®		E1011-8410	96-Tip Rack	Yes	10 x 96	£37.91
		E1011-8800	96-Tip Hinged Rack	No	10 x 96	£30.03
	<b>New!</b>					
<b>200µl Filter Tip / Wide Orifice</b> For use with: ErgoOne®, Gilson®, Biohit®, Brand®, CAPP®, Eppendorf®, FinnpiPETTE®		E1011-8618	96-Tip Rack	Yes	10 x 96	£80.00
		E1011-9000	Bag	No	1000	£21.21
<b>1000µl Graduated Tip / Wide Orifice</b> For use with: ErgoOne®, Gilson®, Costar®, Eppendorf®, FinnpiPETTE®, Fisherbrand®, Nichiryo®, Oxford-Benchmate®, Rainin®, SMI®, Socorex®, StarPet, Titertek®, Volac®		E1011-9500	100-Tip Rack	No	10 x 100	£36.75
		E1011-9510	100-Tip Rack	Yes	10 x 100	£42.32
	<b>New!</b>					
<b>1000µl Tip / Wide Orifice</b> For use with: ErgoOne®, Gilson®, Biohit®, Brand®, CAPP®, Eppendorf®, FinnpiPETTE®		E1011-9600	Bag	No	1000	£22.00
		E1011-9601	100-Tip Rack	No	10 x 100	£46.00
		E1011-9611	100-Tip Rack	Yes	10 x 100	£53.00
	<b>New!</b>					
<b>1000µl Filter Tip / Wide Orifice</b> For use with: ErgoOne®, Gilson®, Biohit®, Brand®, CAPP®, Eppendorf®, FinnpiPETTE®		E1011-9618	96-Tip Rack	Yes	10 x 100	£80.00











# Gel-Extraction Tool

Gel Extraction Tool				
	Cat. No.	Description	Pack Size	Price
		Perform DNA sample extractions with great accuracy and precision in a rapid, four-step process. The disposable polyethylene tool cleanly cuts and picks up uniform slices of gel, eliminating possible cross-contamination from razor blades and other gel-cutting methods.		
	N2000-0025	X-Tracta™ Gel Extraction Tool	25	£14.39
	N2000-0100	X-Tracta™ Gel Extraction Tool	100	£52.19



# Gel-Loading Tips

Round Gel-Loading Tips						
All tips are certified and natural in colour.		Cat. No.	Pack Type	Sterile	Pack Size	Price
 <b>10µl Round Gel-Loading Tip</b> For use with: ErgoOne®, Gilson®, Biohit®, Eppendorf®, Nichiryo®, Oxford-Benchmate®, StarPet	Length: Total 56.62mm / Flexible: 25.30mm. Orifice: OD. 0.58mm / ID. 0.30mm					
	I1010-3000	Bag	No	1000	£28.98	
	I1010-3600	204-Tip Rack	No	5 x 204	£48.93	
	I1010-3610	204-Tip Rack	Yes	5 x 204	£53.97	
 <b>10µl Round Gel-Loading Filter Tip</b> For use with: ErgoOne®, Gilson®, Biohit®, Eppendorf®, Nichiryo®, Oxford-Benchmate®, StarPet	Total Length: 56.62mm Flexible capillary length: 25.30mm. Orifice: OD. 0.58mm / ID. 0.30mm					
	I1010-3800	204-Tip Rack	Yes	1020	£93.45	
 <b>10µl Round Gel-Loading Tip</b> For use with: ErgoOne®, Eppendorf®, Gilson®, Nichiryo®, Oxford-Benchmate®, Socorex®, StarPet	Length: Total 71.25mm / Flexible capillary 25.3mm. Orifice: OD. 0.58mm / ID. 0.30mm					
	I1012-3600	204-Tip Rack	No	8 x 204	£68.99	
	I1012-3610	204-Tip Rack	Yes	8 x 204	£75.71	
 <b>20µl Round Gel-Loading Filter Tip</b> For use with: ErgoOne®, Gilson®, Costar®, Eppendorf®, MLA®, Socorex®, Volac®	Total Length: 68mm. Orifice: OD. 0.60mm / ID. 0.30mm					
	E1021-0618	204-Tip Rack	Yes	5 x 204	£94.61	
 <b>100µl Round Gel-Loading Filter Tip</b> For use with: ErgoOne®, Gilson®, Biohit®, Costar®, Eppendorf®, Finnpiquette®, Nichiryo®, Oxford-Benchmate®, Socorex®, StarPet, Titertek®, Volac®	Total Length: 68mm. Orifice: OD. 0.60mm / ID. 0.30mm					
	E1022-0008	Bag	No	1000	£60.17	
	I1022-0810	204-Tip Rack	Yes	5 x 204	£94.61	
 <b>200µl Round Gel-Loading Tip</b> For use with: ErgoOne®, Gilson®, Biohit®, Eppendorf®, Finnpiquette®, MLA®, Nichiryo®, Oxford-Benchmate®, Rainin®, StarPet, Socorex®, Titertek®, Volac®	Total Length: 68mm. Orifice: OD. 0.60mm / ID. 0.30mm					
	I1022-0000	Bag	No	1000	£31.19	
	I1022-0600	204-Tip Rack	No	5 x 204	£48.93	
	I1022-0610	204-Tip Rack	Yes	5 x 204	£54.50	

Flat Gel-Loading Tips										
All tips are certified and natural in colour.		Cat. No.	Pack Type	Sterile	Tip Thickness	Pack Size	Price			
 <b>10µl Flat Gel-Loading Tip</b> For use with: ErgoOne®, Gilson®, Biohit®, Eppendorf®, Nichiryo®, Oxford-Benchmate®, StarPet	I1012-2600					200-Tip Rack	No	0.20mm	1 x 200	£55.65
	I1012-4600					200-Tip Rack	No	0.40mm	1 x 200	£42.32
 <b>10µl Flat Gel-Loading Tip</b> For use with: ErgoOne®, Eppendorf®, Nichiryo®, Oxford-Benchmate®, Socorex®, StarPet	I1011-2600					200-Tip Rack	No	0.20mm	1 x 200	£55.65
	I1011-4600					200-Tip Rack	No	0.40mm	1 x 200	£50.09
 <b>200µl Flat Gel-Loading Tip</b> For use with: ErgoOne®, Gilson®, Biohit®, Costar®, Eppendorf®, Finnpiquette®, Fisherbrand®, Nichiryo®, Oxford-Benchmate®, Rainin®, Socorex®, StarPet, Titertek®	I1022-2600					200-Tip Rack	No	0.20mm	1 x 200	£55.65
	I1022-4600					200-Tip Rack	No	0.40mm	1 x 200	£62.79

# TipOne® Repeat Dispenser Tips

## TipOne repeat

### Dispenser tips you'll want to use again!

TipOne® Repeat offers high quality, value replacement dispenser tips for many popular dispensing systems.

#### Features

- Available non-sterile bulk, or sterile individually wrapped
- High accuracy and precision
- ISO 8655 manufactured
- Polypropylene cylinder
- Polyethylene piston

#### TipOne® Repeat Tips are compatible with:

- STARLAB RepeatOne® (see page 48)
- Eppendorf® Multipette® 4780
- Brand® Handystep® Manual
- Gilson® Distriman®
- Ritter® Ripette®
- Biohit® Electronic

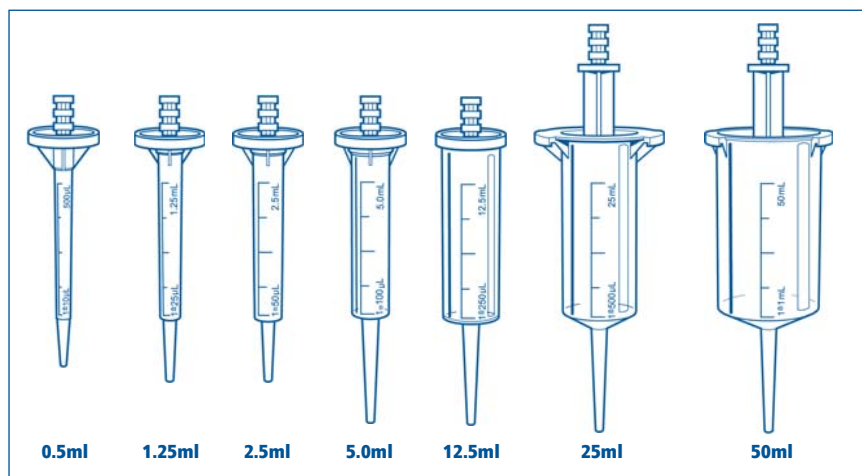

TipOne® Repeat Dispenser Tips			
Cat. No.	Description	Pack Size	Price
<b>Non-Sterile</b>			
S4770-0050	0.5ml TipOne® Repeat Dispenser Tips	100	£54.50
S4772-0125	1.25ml TipOne® Repeat Dispenser Tips	100	£54.50
S4774-0250	2.5ml TipOne® Repeat Dispenser Tips	100	£54.50
S4776-0500	5.0ml TipOne® Repeat Dispenser Tips	100	£54.50
S4778-1250	12.5ml TipOne® Repeat Dispenser Tips	100	£54.50
S4780-2500	25ml TipOne® Repeat Dispenser Tips	50	£27.83
S4782-5000	50ml TipOne® Repeat Dispenser Tips	25	£16.70
S4026-1525	Adaptor for 25ml and 50ml Dispenser Tips	1	£4.83
<b>Sterile, Individually Wrapped</b>			
S4784-0050	0.5ml TipOne® Repeat Dispenser Tips (Sterile)	100	£83.48
S4786-0125	1.25ml TipOne® Repeat Dispenser Tips (Sterile)	100	£83.48
S4788-0250	2.5ml TipOne® Repeat Dispenser Tips (Sterile)	100	£83.48
S4790-0500	5.0ml TipOne® Repeat Dispenser Tips (Sterile)	100	£83.48
S4792-1250	12.5ml TipOne® Repeat Dispenser Tips (Sterile)	100	£83.48
S4794-2500	25ml TipOne® Repeat Dispenser Tips (Sterile)	50	£55.65
S4796-5000	50ml TipOne® Repeat Dispenser Tips (Sterile)	25	£27.83

### Repeat Dispenser

See page 48 for ordering details of STARLAB's RepeatOne® Dispenser



#### Application Guide

Dispenser Tip Volume	Dispenser Adjustment				
	1	2	3	4	5
0.5ml	10µl	20µl	30µl	40µl	50µl
1.25ml	25µl	50µl	75µl	100µl	125µl
2.5ml	50µl	100µl	150µl	200µl	250µl
5.0ml	100µl	200µl	300µl	400µl	500µl
12.5ml	250µl	500µl	750µl	1000µl	1250 µl
25ml	500µl	1000µl	1500µl	2000µl	2500µl
50ml	1000µl	2000µl	3000µl	4000µl	5000µl
<b>Steps*</b>	<b>48</b>	<b>23</b>	<b>15</b>	<b>11</b>	<b>8</b>

\*Number of steps may vary according to dispenser manufacturer.



# *Robotic Tips*

## **STARLAB ROBOTIC TIPS**

Overview ..... 26

## **TIPS FOR BECKMAN COULTER®**

Biomek® 1000 & 2000..... 27

Biomek® 3000 ..... 28–29

Biomek® FX ..... 28–29

Biomek® NX ..... 28–29

Multimek® ..... 28–29

## **TIPS FOR BIOTEK®**

Precision® ..... 30

Precision® XS..... 30

## **TIPS FOR CALIPER® / ZYMARK®**

RapidPlate® 96 ..... 30

SciClone® ..... 30

## **TIPS FOR PACKARD® / PERKIN ELMER®**

MultiProbe® II ..... 31–32

MultiProbe® IIHT/EX ..... 31

Janus® ..... 32–33

Evolution® P3, MiniTrak™ & PlateTrak™ ..... 33

## **TIPS FOR QIAGEN®**

QIAgility® (formerly Corbett CAS-1200) ..... 33

## **TIPS FOR TECAN®**

Aquarius® ..... 36

Freedom EVO® ..... 34–36

Genesis & MiniPrep ..... 34–35

Te-MO™ ..... 36

**ROBOT-TIP COMPATIBILITY** ..... 37

**ROBOTIC RESERVOIRS** ..... 38

# STARLAB Robotic Tips Overview

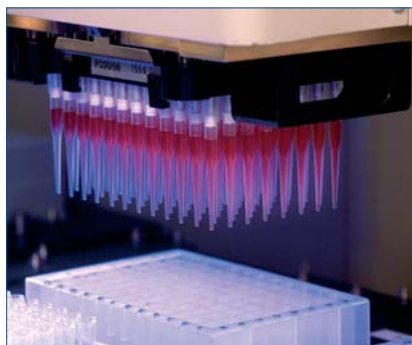

STARLAB robotic tips are engineered to the same specifications as the original equipment manufacturers' tips to ensure compatibility and a consistent fit. Don't risk having your time and results compromised with defective materials and poor performance! With STARLAB, you can put your trust in disposables from a company that offers much more than just tips.

*All robotic tips are certified RNase, DNase and DNA free*

## Quality Control

Quality Control is the essential factor which gives you the freedom to walk away from your automated workstation and get on with other tasks. You need the assurance that the tip will not let you down. STARLAB robotic tips are put through stringent and thorough testing. Every lot of tips is subject to an array of demanding tests, from the geometry of the tip itself to automation-specific requirements such as clean ejection from the liquid handling head. Every lot is required to meet or exceed the parameters necessary to give you that confidence to walk away.

Tips are tested on the original robotic equipment so there is no doubt they will perform to the same requirements as the disposables from the robot manufacturer themselves.

## No Special Set-Up Required!

STARLAB robotic tips require no instrument hardware or software adjustment, thereby providing a simple, safe and direct high-performance substitute.

## Purchasing Flexibility

STARLAB likes to make things as simple as possible for its customers. We realise that you may need to order robotic consumables in large quantities, but may not have the space to store them. STARLAB can help with call-off orders where you buy and own the product, but we store it in our warehouse and 'call off' delivery to you, as and when you need it. Alternatively, you may place a standing order and have a pre-determined quantity delivered at regular intervals. Contact us to discuss your options.

### CASE SIZES available at discount!

Cat. Nos ending in **-C** are case sizes, the number in brackets beside the case price in the ordering information tables is the number of packs per case.









## Recycle your Robotic Tip Racks

Robotic tip racks can be recycled using STARLAB's free recycling collection service. We can set up a recycling service purely for your robotic tip racks, or they can be collected in the same recycling bags and crates with your TipOne® recycling. Whatever is easier for you!

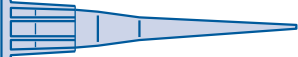
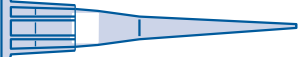
See page 11 for more information on the different recycling options available.

# Tips for Beckman Coulter®

• Biomek® 1000 • Biomek® 2000

	Rack Style/Head	Racks	Sterile Racks
 <b>20µl Conductive Tip*</b>	Blue SBS Rack P200, P1000, MP20, MP200	10 Racks per Pack*  <b>n/a</b>	10 Racks per Pack*  <b>E1075-4488</b> £107.42 <b>E1075-4488-C</b> (5)
 <b>20µl Tip</b>	Grey SBS Rack P20, MP20, P200, MP200	<b>I1060-2400</b> £32.24 <b>I1060-2400-C</b> (5)	<b>I1060-2410</b> £35.60 <b>I1060-2410-C</b> (5)
 <b>20µl Filter Tip</b>	Grey SBS Rack P20, MP20, P200, MP200	<b>n/a</b>	<b>I1060-2810</b> £86.31 <b>I1060-2810-C</b> (5)
 <b>30µl Filter Tip</b>	Orange SBS Rack P20, MP20, P200, MP200	<b>n/a</b>	<b>I1060-5810</b> £85.68 <b>I1060-5810-C</b> (5)
 <b>50µl Tip</b>	Orange SBS Rack P20, MP20, P200, MP200	<b>I1060-5400</b> £42.84 <b>I1060-5400-C</b> (5)	<b>I1060-5410</b> £45.05 <b>I1060-5410-C</b> (5)
 <b>180µl Filter Tip</b>	Black SBS Rack P200, MP200	<b>n/a</b>	<b>I1062-0810</b> £85.68 <b>I1062-0810-C</b> (5)
 <b>250µl Tip</b>	Black SBS Rack P200, MP200	<b>I1062-0400</b> £32.24 <b>I1062-0400-C</b> (5)	<b>I1062-0410</b> £34.55 <b>I1062-0410-C</b> (5)
 <b>1000µl Tip</b>	Black Non-SBS Rack P1000	<b>10 x 72-Tip Racks</b> <b>E1075-3700</b> £68.99 <b>E1075-3700-C</b> (5)	<b>10 x 72-Tip Racks</b> <b>E1075-3710</b> £72.35 <b>E1075-3710-C</b> (5)
 <b>1000µl Filter Tip</b>	Black Non-SBS Rack P1000	<b>n/a</b>	<b>1 x 72-Tip Rack</b> <b>E1075-3810</b> £16.70 <b>E1075-3810-C</b> (5)

\*Conductive tip is also compatible with Packard® MultiProbe® I with 4 Head Probe.

\*Pack sizes are 10 x 96-tip racks, unless stated otherwise.

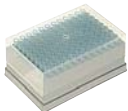











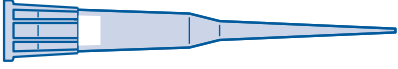
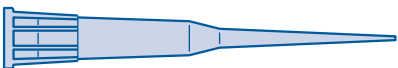

### CASE SIZES available at discount!

Cat. Nos ending in **-C** are case sizes, the number in brackets beside the case price is the number of packs per case.

# Tips for Beckman Coulter®

• Biomek® FX • Biomek® NX • Biomek® 3000 • Multimek®

Robotic Tips

	Rack Style / Head	Non-Sterile	Sterile
		10 Racks per Pack	10 Racks per Pack
 <b>10µl Tip</b>	Violet SBS Rack AP96, SPAN-8, MP20	<b>E1076-1400</b> £40.11 <b>E1076-1400-C</b> (5)	<b>E1076-1410</b> £45.68 <b>E1076-1410-C</b> (5)
 <b>20µl Tip</b>	Pale Blue SBS Rack AP96, SPAN-8, MP20	<b>E1076-4400</b> £37.28 <b>E1076-4400-C</b> (5)	<b>E1076-4410</b> £40.11 <b>E1076-4410-C</b> (5)
 <b>20µl Filter Tip</b>	Pale Blue SBS Rack AP96, SPAN-8, MP20	<b>n/a</b>	<b>E1076-4418</b> £91.25 <b>E1076-4418-C</b> (5)
 <b>30µl Filter Tip</b>	Orange SBS Rack AP96, SPAN-8, MP20, MP200	<b>n/a</b>	<b>E1076-2418</b> £91.25 <b>E1076-2418-C</b> (5)
 <b>50µl Tip</b>	Orange SBS Rack AP96, SPAN-8, MP20, MP200	<b>E1076-2400</b> £48.41 <b>E1076-2400-C</b> (5)	<b>E1076-2410</b> £51.14 <b>E1076-2410-C</b> (5)
 <b>175µl Filter Tip</b>	Green SBS Rack AP96, SPAN-8, MP200	<b>n/a</b>	<b>E1076-0418</b> £102.38 <b>E1076-0418-C</b> (5)
 <b>250µl Tip</b>	Green SBS Rack AP96, SPAN-8, MP200	<b>E1076-0400</b> £37.28 <b>E1076-0400-C</b> (5)	<b>E1076-0410</b> £40.11 <b>E1076-0410-C</b> (5)
 <b>25µl 384-Format Filter Tip</b>	 Green SBS Rack AP384	<b>n/a</b>	<b>E1076-3810</b> £690.06 <b>E1076-3810-C</b> (5)
 <b>30µl 384-Format Tip</b>	 Green SBS Rack AP384	<b>E1076-3400</b> £456.33 <b>E1076-3400-C</b> (5)	<b>E1076-3410</b> £489.72 <b>E1076-3410-C</b> (5)
 <b>30µl 384-Format XL Filter Tip</b>	 Green SBS Rack AP384	<b>n/a</b>	<b>E1076-5411</b> £701.19 <b>E1076-5411-C</b> (5)
 <b>50µl 384-Format XL Tip</b>	 Green SBS Rack AP384	<b>E1076-5810</b> £489.72 <b>E1076-5810-C</b> (5)	<b>E1076-5401</b> £523.11 <b>E1076-5401-C</b> (5)

96-well tips also compatible with Gilson® Cyberlab®.  
384-well tips also compatible with Dynamic Devices® Oasis® LM with 384-channel low volume head,  
and Hamilton® Microlab® STAR, STARlet & STARplus with 384 head.

AP96 & SPAN-8 compatible

No special set-up required!



Engineered to the exact specifications as original manufacturer's tips

New, easy-release tape opening on sterile product

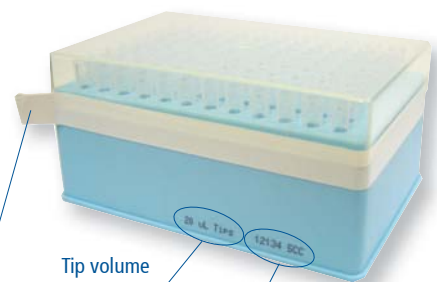

Tip volume printed on every rack

Lot No. printed on every rack

# Tips for Beckman Coulter®

• Biomek® FX • Biomek® NX • Biomek® 3000 • Multimek®

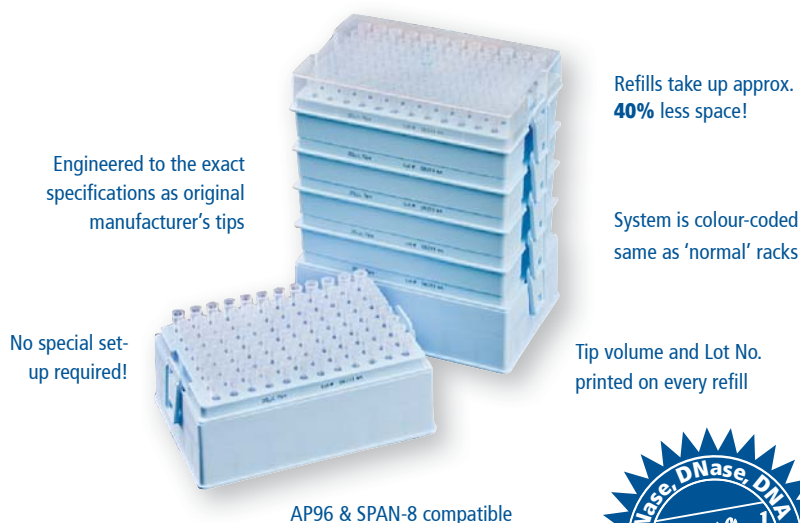

## Economical, eco-friendly and space saving refill system!

- Refillable racks and space-saving refill stacks
- Refills take up **40% less space!**
- Quick and easy racking with easy-locate tabs on each refill
- Reusable racks means less waste and less cost
- No programming or software changes required
- Recycle the refill wafers with your other STARLAB recycling (see page 11)



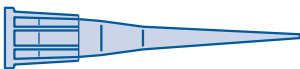

## Refillable racks

Get yourself started by first buying the refillable racks.

Refillable Racks	Rack Style / Head	Non-Sterile	Sterile
		10 Pre-Filled Refillable Racks	10 Pre-Filled Refillable Racks
 <b>20µl Tip</b>	Pale Blue Refillable Rack AP96, SPAN-8	<b>E1076-4800</b> £31.19 <b>E1076-4800-C</b> (5)	<b>E1076-4810</b> £35.60 <b>E1076-4810-C</b> (5)
 <b>250µl Tip</b>	Green Refillable Rack AP96, SPAN-8	<b>E1076-0800</b> £31.19 <b>E1076-0800-C</b> (5)	<b>E1076-0810</b> £35.60 <b>E1076-0810-C</b> (5)

## Refills

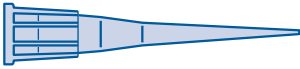
Once you have used the tips from the refillable racks above, refill the racks to save both money and plastic waste!

Refills	Rack Style / Head	Non-Sterile	Sterile
		2 Stacks of 5 Refills	2 Stacks of 5 Refills
 <b>20µl Tip</b>	Pale Blue Refill AP96, SPAN-8	<b>E1076-4700</b> £28.98 <b>E1076-4700-C</b> (5)	<b>E1076-4710</b> £32.34 <b>E1076-4710-C</b> (5)
 <b>250µl Tip</b>	Green Refill AP96, SPAN-8	<b>E1076-0700</b> £28.98 <b>E1076-0700-C</b> (5)	<b>E1076-0710</b> £32.34 <b>E1076-0710-C</b> (5)

## CASE SIZES available at discount!









Cat. Nos ending in **-C** are case sizes, the number in brackets beside the case price is the number of packs per case.



**The refill**  
is easy to use  
– just press in the  
tabs on the side to  
insert or remove

## Tips for Biotek®







• Precision® • Precision® XS

		Rack Style / Head	Non-Sterile	Sterile
			10 Racks per Pack	10 Racks per Pack
 50µl Tip*	<i>New!</i>	Green SBS Rack 8- or 12-Head	<b>E1074-2500</b> £84.00 <b>E1074-2500-C</b> (5)	<b>E1074-2510</b> £86.50 <b>E1074-2510-C</b> (5)
 50µl Filter Tip*	<i>New!</i>	Green SBS Rack 8- or 12-Head	n/a	<b>E1074-2518</b> £98.25 <b>E1074-2518-C</b> (5)
 80µl Filter Tip*	<i>New!</i>	Grey SBS Rack 8- or 12-Head	n/a	<b>E1074-2118</b> £98.25 <b>E1074-2118-C</b> (5)
 100µl Tip*	<i>New!</i>	Grey SBS Rack 8- or 12-Head	<b>E1074-2100</b> £84.00 <b>E1074-2100-C</b> (5)	<b>E1074-2110</b> £86.50 <b>E1074-2110-C</b> (5)
 180µl Filter Tip*	<i>New!</i>	Blue SBS Rack 8- or 12-Head	n/a	<b>E1074-2218</b> £98.25 <b>E1074-2218-C</b> (5)
 200µl Tip*	<i>New!</i>	Blue SBS Rack 8- or 12-Head	<b>E1074-2200</b> £84.00 <b>E1074-2200-C</b> (5)	<b>E1074-2210</b> £86.50 <b>E1074-2210-C</b> (5)
 200µl Tip		Blue SBS Rack Single, 8- or 12-Head	<b>E1074-2400</b> £50.90 <b>E1074-2400-C</b> (5)	<b>E1074-2410</b> £71.40 <b>E1074-2410-C</b> (5)
 200µl Filter Tip		Blue SBS Rack Single, 8- or 12-Head	n/a	<b>E1074-2418</b> £83.48 <b>E1074-2418-C</b> (5)

\*These tips are also compatible with Tecan® Freedom EVO®, TeMo™ and Aquarius®, and Zymark®/Caliper® RapidPlate® and SciClone® robotic systems.

## Tips for Caliper® / Zymark®

• RapidPlate® 96 • SciClone®

		Rack Style / Head	Non-Sterile	Sterile
			10 Racks per Pack	10 Racks per Pack
 50µl Tip		Green Non-SBS Rack HV96	<b>E1015-5800</b> £38.96 <b>E1015-5800-C</b> (5)	<b>E1015-5810</b> £44.52 <b>E1015-5810-C</b> (5)
 50µl Filter Tip		Green Non-SBS Rack HV96	n/a	<b>E1025-5810</b> £82.43 <b>E1025-5810-C</b> (5)
 80µl Filter Tip		Grey Non-SBS Rack HV96	n/a	<b>E1025-1810</b> £89.04 <b>E1025-1810-C</b> (5)
 100µl Tip		Grey Non-SBS Rack HV96	<b>E1015-1801</b> £38.96 <b>E1015-1801-C</b> (5)	<b>E1025-1811</b> £44.52 <b>E1025-1811-C</b> (5)
 150µl Filter Tip		Purple Non-SBS Rack HV96	n/a	<b>I1016-0810</b> £77.91 <b>I1016-0810-C</b> (5)
 200µl Tip		Purple Non-SBS Rack HV96	<b>I1016-0400</b> £38.96 <b>I1016-0400-C</b> (5)	<b>I1016-0410</b> £42.32 <b>I1016-0410-C</b> (5)

















See also the tips above, for use on RapidPlate® and SciClone® robotic systems with SBS plates.





# Tips for Packard®

• MultiProbe® II • MultiProbe® IIHT/EX















	Rack Style / Head	Non-Sterile	Sterile
		24 Racks per Pack	24 Racks per Pack
 <b>10µl Tip</b>	White Hanging Rack Varispan with 4 or 8 head probe	<b>R1181-3700</b> £333.90	<b>R1081-3700</b> £361.73
 <b>10µl Filter Tip</b>	White Hanging Rack Varispan with 4 or 8 head probe	<b>R1128-3810</b> £345.03	<b>R1028-3810</b> £379.58
 <b>50µl Tip</b>	White Hanging Rack Varispan with 4 or 8 head probe	<b>R1181-5700</b> £333.90	<b>R1081-5700</b> £356.16
 <b>50µl Filter Tip</b>	White Hanging Rack Varispan with 4 or 8 head probe	<b>R1128-5810</b> £345.03	<b>R1028-5810</b> £374.01
 <b>200µl Tip</b>	White Hanging Rack Varispan with 4 or 8 head probe	<b>R1181-0700</b> £94.61	<b>R1081-0700</b> £116.87
 <b>200µl Filter Tip</b>	White Hanging Rack Varispan with 4 or 8 head probe	<b>R1128-0810</b> £128.00	<b>R1028-0810</b> £133.56
 <b>1000µl Tip</b>	White Hanging Rack Varispan with 4 or 8 head probe	<b>R1181-2700</b> £122.43	<b>R1081-2700</b> £133.56
 <b>1000µl Filter Tip</b>	White Hanging Rack Varispan with 4 or 8 head probe	<b>R1128-2810</b> £155.82	<b>R1028-2810</b> £169.16
 <b>10µl Conductive Tip</b>	White Hanging Rack Varispan with 4 or 8 head probe	<b>R1181-3709</b> £333.90	<b>R1081-3709</b> £356.16
 <b>10µl Conductive Filter Tip</b>	White Hanging Rack Varispan with 4 or 8 head probe	<b>R1128-3819</b> £345.03	<b>R1028-3819</b> £367.29
 <b>50µl Conductive Tip</b>	White Hanging Rack Varispan with 4 or 8 head probe	<b>R1181-5709</b> £333.90	<b>R1081-5709</b> £350.60
 <b>50µl Conductive Filter Tip</b>	White Hanging Rack Varispan with 4 or 8 head probe	<b>R1128-5819</b> £345.03	<b>R1028-5819</b> £367.29
 <b>200µl Conductive Tip</b>	White Hanging Rack Varispan with 4 or 8 head probe	<b>R1181-0709</b> £111.30	<b>R1081-0709</b> £122.43
 <b>200µl Conductive Filter Tip</b>	White Hanging Rack Varispan with 4 or 8 head probe	<b>R1128-0819</b> £150.26	<b>R1028-0819</b> £163.59
 <b>1000µl Conductive Tip</b>	White Hanging Rack Varispan with 4 or 8 head probe	<b>R1181-2709</b> £128.00	<b>R1081-2709</b> £128.00
 <b>1000µl Conductive Filter Tip</b>	White Hanging Rack Varispan with 4 or 8 head probe	<b>R1128-2819</b> £166.95	<b>R1028-2819</b> £180.29

Also compatible with: Aurora Biomed® Versa™ systems with 8-channel head, and Qiagen® QiAgility® (CAS-1200) with single-channel head.

Pack sizes only available in this range.

# Tips for Perkin Elmer®







• MultiProbe® II • Janus®

	Rack Style / Head	Non-Sterile	Sterile
		10 Racks per Pack*	10 Racks per Pack*
 <b>20µl Tip</b>	Green/Blue SBS Rack Varispan-1, -4, -8	<b>E1178-2400</b> £106.00 <b>E1178-2400-C (5)</b>	<b>E1178-2410</b> £144.69 <b>E1178-2410-C (5)</b>
 <b>25µl Filter Tip</b>	Green/Green SBS Rack Varispan-1, -4, -8	<b>n/a</b>	<b>E1178-5418</b> £128.00 <b>E1178-5418-C (5)</b>
 <b>50µl Tip</b>	Green/Green SBS Rack Varispan-1, -4, -8	<b>E1178-5400</b> £111.30 <b>E1178-5400-C (5)</b>	<b>E1178-5410</b> £144.69 <b>E1178-5410-C (5)</b>
 <b>175µl Filter Tip</b>	Green/Red SBS Rack Varispan-1, -4, -8,	<b>n/a</b>	<b>E1178-6418</b> £128.00 <b>E1178-6418-C (5)</b>
 <b>200µl Tip</b>	Green/Red SBS Rack Varispan-1, -4, -8,	<b>E1178-6400</b> £111.30 <b>E1178-6400-C (5)</b>	<b>E1178-6410</b> £144.69 <b>E1178-6410-C (5)</b>
 <b>1000µl Tip</b>	White Hanging Rack Varispan-1, -4, -8	<b>Pack Size: 24 Racks</b> <b>R1181-2700</b> £122.43	<b>Pack Size: 24 Racks</b> <b>R1081-2700</b> £133.56
 <b>1000µl Filter Tip</b>	White Hanging Rack Varispan-1, -4, -8	<b>Pack Size: 24 Racks</b> <b>R1128-2810</b> £155.82	<b>Pack Size: 24 Racks</b> <b>R1028-2810</b> £169.16
 <b>20µl Conductive Tip</b>	Green/Blue SBS Rack Varispan-1, -4, -8	<b>E1178-2408</b> £133.56 <b>E1178-2408-C (5)</b>	<b>E1178-2418</b> £166.95 <b>E1178-2418-C (5)</b>
 <b>25µl Conductive Filter Tip</b>	Green/Green SBS Rack Varispan-1, -4, -8	<b>n/a</b>	<b>E1178-5488</b> £133.56 <b>E1178-5488-C (5)</b>
 <b>50µl Conductive Tip</b>	Green/Green SBS Rack Varispan-1, -4, -8	<b>E1178-5408</b> £133.56 <b>E1178-5408-C (5)</b>	<b>E1178-5428</b> £166.95 <b>E1178-5428-C (5)</b>
 <b>175µl Conductive Filter Tip</b>	Green/Red SBS Rack Varispan-1, -4, -8	<b>n/a</b>	<b>E1178-6488</b> £161.39 <b>E1178-6488-C (5)</b>
 <b>200µl Conductive Tip</b>	Green/Red SBS Rack Varispan-1, -4, -8	<b>E1178-6408</b> £133.56 <b>E1178-6408-C (5)</b>	<b>E1178-6428</b> £166.95 <b>E1178-6428-C (5)</b>
 <b>1000µl Conductive Tip</b>	White Hanging Rack Varispan-1, -4, -8	<b>Pack Size: 24 Racks</b> <b>R1181-2709</b> £128.00	<b>Pack Size: 24 Racks</b> <b>R1081-2709</b> £128.00
 <b>1000µl Conductive Filter Tip</b>	White Hanging Rack Varispan-1, -4, -8	<b>Pack Size: 24 Racks</b> <b>R1128-2819</b> £166.95	<b>Pack Size: 24 Racks</b> <b>R1028-2819</b> £180.29

\*Pack sizes are 10 x 96-tip racks, unless stated otherwise.

## Tips for Perkin Elmer®

• Janus® • Evolution® P<sup>3</sup> • MiniTrak™ • PlateTrak™

	Rack Style / Head	Non-Sterile	Sterile
		10 Racks per Pack	10 Racks per Pack
 <b>20µl Tip</b>	Green SBS Rack MDT-96 P50	<b>E1078-2400</b> £44.52 <b>E1078-2400-C (5)</b>	<b>E1078-2410</b> £50.09 <b>E1078-2410-C (5)</b>
 <b>20µl Filter Tip</b>	Green SBS Rack MDT-96 P50	n/a	<b>E1078-2810</b> £83.48 <b>E1078-2810-C (5)</b>
 <b>30µl Filter Tip</b>	Green SBS Rack MDT-96 P50	n/a	<b>E1078-5418</b> £83.48 <b>E1078-5418-C (5)</b>
 <b>50µl Tip</b>	Green SBS Rack MDT-96 P50	<b>E1078-5400</b> £41.16 <b>E1078-5400-C (5)</b>	<b>E1078-5410</b> £46.73 <b>E1078-5410-C (5)</b>
 <b>180µl Filter Tip</b>	Green SBS Rack MDT-96 P235	n/a	<b>E1078-6418</b> £83.48 <b>E1078-6418-C (5)</b>
 <b>235µl Tip</b>	Green SBS Rack MDT-96 P235	<b>E1078-6400</b> £41.16 <b>E1078-6400-C (5)</b>	<b>E1078-6410</b> £44.52 <b>E1078-6410-C (5)</b>





**FREE SAMPLE**  
**TRY**  
before you  
**BUY**  
available on request



## Tips for Qiagen®

• QIAgility® (formerly CAS-1200)

	Rack Style / Head	Non-Sterile	Sterile
		10 Racks per Pack	10 Racks per Pack
 <b>50µl Conductive Filter Tip</b>	Clear Hanging Rack Single-Channel Pipette	n/a	<b>E1172-1418</b> £128.00 <b>E1172-1418-C (5)</b>
 <b>200µl Conductive Filter Tip</b>	Clear Hanging Rack Single-Channel Pipette	n/a	<b>E1173-2418</b> £124.64 <b>E1173-2418-C (5)</b>

### CASE SIZES available at discount!













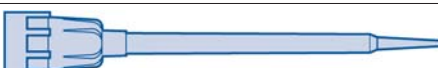
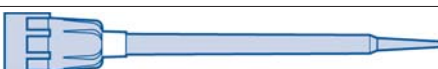

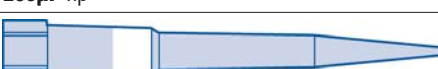
Cat. Nos ending in **-C** are case sizes, the number in brackets beside the case price is the number of packs per case.



# Tips for Tecan® (with LiHa)

• Freedom EVO® • Genesis® Series • MiniPrep®

Robotic Tips

	Rack Style / Head	Non-Sterile	Sterile
<b>Tips for research purposes only</b>		24 Racks per Pack	24 Racks per Pack
 <b>10µl Tip</b>	White Hanging Rack Varispan with 4 or 8 head probe	<b>R1181-3700</b> £333.90	<b>R1081-3700</b> £361.73
 <b>10µl Filter Tip</b>	White Hanging Rack Varispan with 4 or 8 head probe	<b>R1128-3810</b> £345.03	<b>R1028-3810</b> £379.58
 <b>50µl Tip</b>	White Hanging Rack Varispan with 4 or 8 head probe	<b>R1181-5700</b> £333.90	<b>R1081-5700</b> £356.16
 <b>50µl Filter Tip</b>	White Hanging Rack Varispan with 4 or 8 head probe	<b>R1128-5810</b> £345.03	<b>R1028-5810</b> £374.01
 <b>200µl Tip</b>	White Hanging Rack Varispan with 4 or 8 head probe	<b>R1181-0700</b> £94.61	<b>R1081-0700</b> £116.87
 <b>200µl Filter Tip</b>	White Hanging Rack Varispan with 4 or 8 head probe	<b>R1128-0810</b> £128.00	<b>R1028-0810</b> £133.56
 <b>1000µl Tip</b>	White Hanging Rack Varispan with 4 or 8 head probe	<b>R1181-2700</b> £122.43	<b>R1081-2700</b> £133.56
 <b>1000µl Filter Tip</b>	White Hanging Rack Varispan with 4 or 8 head probe	<b>R1128-2810</b> £155.82	<b>R1028-2810</b> £169.16
 <b>10µl Conductive Tip</b>	White Hanging Rack Varispan with 4 or 8 head probe	<b>R1181-3709</b> £333.90	<b>R1081-3709</b> £356.16
 <b>10µl Conductive Filter Tip</b>	White Hanging Rack Varispan with 4 or 8 head probe	<b>R1128-3819</b> £345.03	<b>R1028-3819</b> £367.29
 <b>50µl Conductive Tip</b>	White Hanging Rack Varispan with 4 or 8 head probe	<b>R1181-5709</b> £333.90	<b>R1081-5709</b> £350.60
 <b>50µl Conductive Filter Tip</b>	White Hanging Rack Varispan with 4 or 8 head probe	<b>R1128-5819</b> £345.03	<b>R1028-5819</b> £367.29
 <b>200µl Conductive Tip</b>	White Hanging Rack Varispan with 4 or 8 head probe	<b>R1181-0709</b> £111.30	<b>R1081-0709</b> £122.43
 <b>200µl Conductive Filter Tip</b>	White Hanging Rack Varispan with 4 or 8 head probe	<b>R1128-0819</b> £150.26	<b>R1028-0819</b> £163.59
 <b>1000µl Conductive Tip</b>	White Hanging Rack Varispan with 4 or 8 head probe	<b>R1181-2709</b> £128.00	<b>R1081-2709</b> £128.00
 <b>1000µl Conductive Filter Tip</b>	White Hanging Rack Varispan with 4 or 8 head probe	<b>R1128-2819</b> £166.95	<b>R1028-2819</b> £180.29

Also compatible with: Aurora Biomed® Versa™ systems with 8-channel head, and Qiagen® QiAgility® (CAS-1200) with single-channel head.

















Pack sizes only available in this range.  
Racks supplied in individual blister packs.



# Tips for Tecan® (with LiHa)

◆ Freedom EVO® ◆ Genesis® Series ◆ MiniPrep®



	Rack Style / Head	Non-Sterile	Sterile
		10 Racks per Pack	10 Racks per Pack
 <b>10µl Tip</b>	Clear Hanging Rack Varispan with 4 or 8 head probe	<b>E1171-0400</b> £66.78 <b>E1171-0400-C</b> (5)	<b>E1171-0410</b> £74.03 <b>E1171-0410-C</b> (5)
 <b>10µl Filter Tip</b>	Clear Hanging Rack Varispan with 4 or 8 head probe	n/a	<b>E1171-0488</b> £87.99 <b>E1171-0488-C</b> (5)
 <b>50µl Tip</b>	Clear Hanging Rack Varispan with 4 or 8 head probe	<b>E1172-1400</b> £68.46 <b>E1172-1400-C</b> (5)	<b>E1172-1410</b> £77.91 <b>E1172-1410-C</b> (5)
 <b>50µl Filter Tip</b>	Clear Hanging Rack Varispan with 4 or 8 head probe	n/a	<b>E1172-1488</b> £91.25 <b>E1172-1488-C</b> (5)
 <b>200µl Tip</b>	Clear Hanging Rack Varispan with 4 or 8 head probe	<b>E1173-2400</b> £65.73 <b>E1173-2400-C</b> (5)	<b>E1173-2410</b> £74.55 <b>E1173-2410-C</b> (5)
 <b>200µl Filter Tip</b>	Clear Hanging Rack Varispan with 4 or 8 head probe	n/a	<b>E1173-2488</b> £87.89 <b>E1173-2488-C</b> (5)
 <b>1000µl Tip</b>	Clear Hanging Rack Varispan with 4 or 8 head probe	<b>E1175-3400</b> £71.82 <b>E1175-3400-C</b> (5)	<b>E1175-3410</b> £79.59 <b>E1175-3410-C</b> (5)
 <b>1000µl Filter Tip</b>	Clear Hanging Rack Varispan with 4 or 8 head probe	n/a	<b>E1175-3488</b> £92.93 <b>E1175-3488-C</b> (5)
 <b>10µl Conductive Tip</b>	Clear Hanging Rack Varispan with 4 or 8 head probe	<b>E1171-0402</b> £92.40 <b>E1171-0402-C</b> (5)	<b>E1171-0412</b> £96.29 <b>E1171-0412-C</b> (5)
 <b>10µl Conductive Filter Tip</b>	Clear Hanging Rack Varispan with 4 or 8 head probe	n/a	<b>E1171-0418</b> £138.08 <b>E1171-0418-C</b> (5)
 <b>50µl Conductive Tip</b>	Clear Hanging Rack Varispan with 4 or 8 head probe	<b>E1172-1402</b> £96.60 <b>E1172-1402-C</b> (5)	<b>E1172-1412</b> £107.94 <b>E1172-1412-C</b> (5)
 <b>50µl Conductive Filter Tip</b>	Clear Hanging Rack Varispan with 4 or 8 head probe	n/a	<b>E1172-1418</b> £128.00 <b>E1172-1418-C</b> (5)
 <b>200µl Conductive Tip</b>	Clear Hanging Rack Varispan with 4 or 8 head probe	<b>E1173-2402</b> £92.40 <b>E1173-2402-C</b> (5)	<b>E1173-2412</b> £104.06 <b>E1173-2412-C</b> (5)
 <b>200µl Conductive Filter Tip</b>	Clear Hanging Rack Varispan with 4 or 8 head probe	n/a	<b>E1173-2418</b> £124.64 <b>E1173-2418-C</b> (5)
 <b>1000µl Conductive Tip</b>	Clear Hanging Rack Varispan with 4 or 8 head probe	<b>E1175-3402</b> £100.17 <b>E1175-3402-C</b> (5)	<b>E1175-3412</b> £111.83 <b>E1175-3412-C</b> (5)
 <b>1000µl Conductive Filter Tip</b>	Clear Hanging Rack Varispan with 4 or 8 head probe	n/a	<b>E1175-3418</b> £131.36 <b>E1175-3418-C</b> (5)







Also compatible with: Aurora Biomed® Versa™ systems with 8-channel head, and Qiagen® QiAgility® (CAS-1200) with single-channel head.

Racks supplied in cardboard cartons (2 racks per carton).

# Tips for Tecan®

• Aquarius® • Freedom EVO® • Te-MO™

Robotic Tips

	Rack Style / Head	Non-Sterile	Sterile
		10 Racks per Pack	10 Racks per Pack
 <b>50µl Tip</b>	Green Non-SBS Rack MCA96, Te-MO 96	<b>E1015-5800</b> £38.96 <b>E1015-5800-C</b> (5)	<b>E1015-5810</b> £44.52 <b>E1015-5810-C</b> (5)
 <b>50µl Filter Tip</b>	Green Non-SBS Rack MCA96, Te-MO 96	n/a	<b>E1025-5810</b> £82.43 <b>E1025-5810-C</b> (5)
 <b>80µl Filter Tip*</b>	Grey Non-SBS Rack MCA96, Te-MO 96	n/a	<b>E1025-1810</b> £89.04 <b>E1025-1810-C</b> (5)
 <b>100µl Tip*</b>	Grey Non-SBS Rack MCA96, Te-MO 96	<b>E1015-1801</b> £38.96 <b>E1015-1801-C</b> (5)	<b>E1025-1811</b> £44.52 <b>E1025-1811-C</b> (5)
 <b>180µl Filter Tip*</b>	Blue Non-SBS Rack MCA96, Te-MO 96	n/a	<b>E1015-2810</b> £94.61 <b>E1015-2810-C</b> (5)
 <b>200µl Tip*</b>	Blue Non-SBS Rack MCA96, Te-MO 96	<b>E1015-2000</b> £38.96 <b>E1015-2000-C</b> (5)	<b>E1015-2010</b> £44.52 <b>E1015-2010-C</b> (5)

\*These tips also compatible with Corbett CAS-4200.

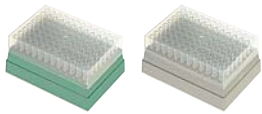



**CASE SIZES available at discount!**

Cat. Nos ending in **-C** are case sizes, the number in brackets beside the case price is the number of packs per case.



# Tips for Tecan®

• Refills for Te-MO™

	Rack Style / Head	Refills
		10 Refills per Pack
 <b>150µl Filter Tip (Sterile)</b>	Yellow Refill Wafer Te-Mo 96	<b>R1129-1810</b> £77.91 <b>R1129-1810-C</b> (8)
 <b>200µl Tip</b>	Yellow Refill Wafer Te-Mo 96	<b>R1188-1700</b> £38.96 <b>R1188-1700-C</b> (18)

Also compatible with Caliper/Zymark RapidPlate® 96 robotic systems.



**Frame** for Tecan Te-MO™ Refills  
(Required to use the refills, LiHa Option)

**A1188-0700**  
£66.78 each

**Frame** Tecan® Te-MO™ Refills  
(Required to use the refills, MCA Option)

**A1188-0701**  
£83.48 each

# Robot–Tip Compatibility

	Page 27	Page 28	Page 29	Page 30	Page 31	Page 32	Page 33	Page 34	Page 35	Page 36
Aurora Biomed® Versa™: 8-Channel					✓			✓	✓	
Beckman® Biomek® 1000/2000: P20, MP20, P200, MP200, P1000	✓									
Beckman® Biomek® 3000: AP96, MP20, MP200, AP384		✓								
Beckman® Biomek® FX: AP96, SPAN-8		✓	✓							
Beckman® Biomek® FX: MP20, MP200, AP384		✓								
Beckman® Biomek® NX: AP96, SPAN-8		✓	✓							
Beckman® Biomek® NX: MP20, MP200, AP384		✓								
Beckman® Multimek®: AP96		✓	✓							
Beckman® Multimek®: MP20, MP200		✓								
Biotek® Precision™ & Precision™ XS: Single, 8 or 12-Head				✓						
Caliper®/Zymer® RapidPlate® 96: HV96				✓						
Caliper®/Zymer® SciClone®: HV96				✓						
Corbett® CAS-1200: Single-Channel Head					✓			✓	✓	
Corbett® CAS-4200: 1-ch.20-150 µl.sec, HV96										✓
Dynamic Devices® Oasis® LM: 384-Ch Low Volume		✓								
Gilson® Cyberlab®		✓								
Hamilton® Microlab® STAR, STARlet, STARplus: 384 Head		✓								
Packard® Multiprobe® I: 4 Head Probe	✓									
Packard® Multiprobe® II: Varispan -4 -8					✓	✓				
Packard® Multiprobe® IIEX/HT: Varispan -1, -4 -8					✓					
Perkin Elmer® Evolution® P3: MDT-96 P50, P235							✓			
Perkin Elmer® Janus®: MDT-96 P50, P235,							✓			
Perkin Elmer® Janus®: Varispan -1, -4 -8						✓				
Perkin Elmer® MiniTrak™: MDT-96 P50, MDT-96 P235							✓			
Perkin Elmer® PlateTrak™: MDT-96 P50, MDT-96 P235							✓			
Qiagen® QiAgility®: Single-Channel Pipette					✓		✓	✓	✓	
Tecan® Aquarius®: MCA96				✓						✓
Tecan® Freedom EVO®: MCA96				✓						✓
Tecan® Freedom EVO®: LiHa-1, -4 & -8								✓	✓	
Tecan® Genesis: LiHa-1, -4 & -8								✓	✓	
Tecan® MiniPrep: LiHa-1, -4 & -8								✓	✓	
Tecan® Te-MO™: Te-MO 96				✓						✓
Tecan® Te-MO™: MCA 96										✓



This chart is intended as a guide only. Please check the relevant page to ensure a specific tip's compatibility with your robotic system and the head type. Contact us for a free sample rack of tips to ensure compatibility with your robotic system before placing an order.

# Robotic Reservoirs



## High quality for high throughput!

STARLAB reservoirs conform to the standard SBS footprint for compatibility with most robotic systems. They have virtually no dead volume and are available in high- or low-profile and three well styles. The sturdy polypropylene construction ensures rigidity during automation and provides excellent chemical resistance.

Robotic Reservoirs

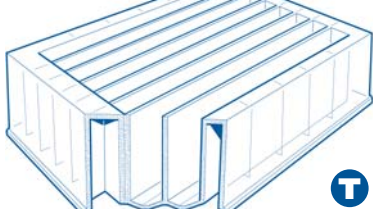

**Multi-Well 8-Channel High Profile**  
80ml reservoir, multi-well with 8 x 10ml troughs

**T** E2999-8008  
£162.54 /pack 25

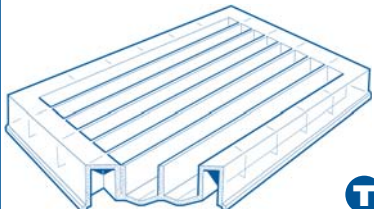

**Multi-Well 8-Channel Low Profile**  
32ml reservoir, multi-well with 8 x 4.0ml troughs

**T** E2999-3208  
£162.54 /pack 25

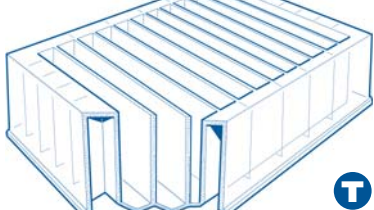

**Multi-Well 12-Channel High Profile**  
84ml reservoir, multi-well with 12 x 7.0ml troughs

**T** E2999-8412  
£162.54 /pack 25

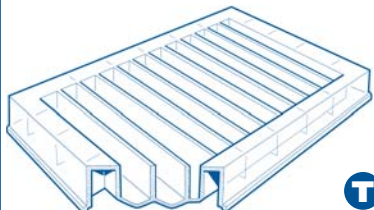

**Multi-Well 12-Channel Low Profile**  
21ml reservoir, multi-well with 12 x 1.75ml troughs

**T** E2999-2112  
£162.54 /pack 25

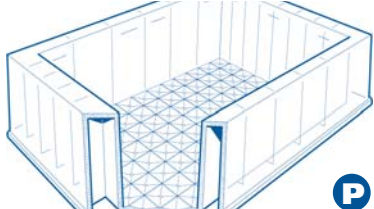

**Single-Well 96 Pyramid Bottoms High Profile**  
240ml reservoir, single-well with 96 pyramid wells

**P** E2999-2496  
£162.54 /pack 25

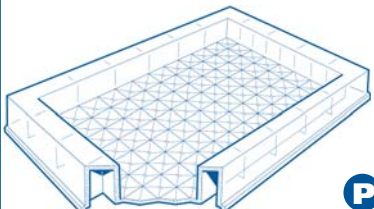

**Single-Well 96 Pyramid Bottoms Low Profile**  
86ml reservoir, single-well with 96 pyramid wells

**P** E2999-8696  
£162.54 /pack 25

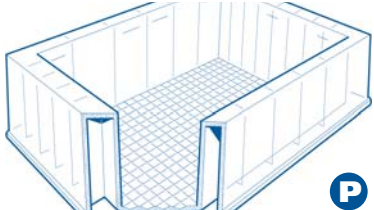

**Single-Well 384 Pyramid Bottoms High Profile**  
282ml reservoir, single-well with 384 pyramid wells

**P** E2999-2384  
£162.54 /pack 25

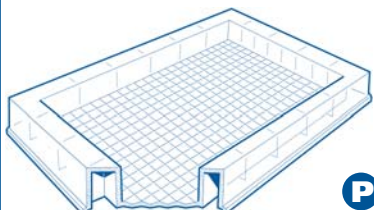

**Single-Well 384 Pyramid Bottoms Low Profile**  
92ml reservoir, single-well with 384 pyramid wells

**P** E2999-9238  
£162.54 /pack 25

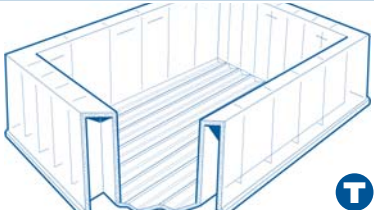

**Single-Well 8 Trough Bottoms High Profile**  
290ml reservoir, single-well with 8 troughs

**T** E2999-2908  
£162.54 /pack 25

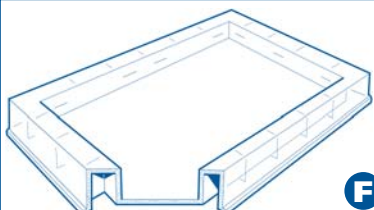

**Single-Well Flat Bottom Low Profile**  
90ml reservoir, single-well with flat bottom

**F** E2999-0901  
£162.54 /pack 25

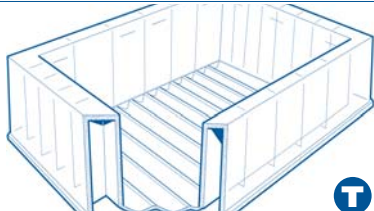

**Single-Well 12 Trough Bottoms High Profile**  
290ml reservoir, single-well with 12 troughs

**T** E2999-2912  
£162.54 /pack 25

All robotic reservoirs are certified RNase, DNase and Pyrogen free

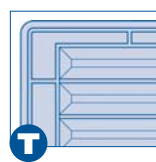

**TROUGH**

Troughs extend the length/width of reservoir, ideal for 8/12 channel applications

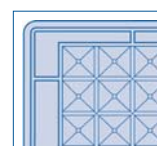

**PYRAMID**

Pyramid -shaped collection pools to help minimise dead volume

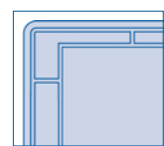

**FLAT**

Guaranteed flatness for a variety of applications

**Universal PP Lid for all SBS plates & robotic reservoirs**

Cat. No. E2999-0000 £94.61 / pack 2 x 50 (See page 82 for more info.)





# Pipettes

## MANUAL PIPETTES

ErgoOne® Pipettes Overview .....	40–41
ErgoOne® Single-Channel Pipettes .....	42
ErgoOne® Multi-Channel Pipettes .....	43
Pipette Stands .....	43
CAPP® Multi-Channel Pipettes.....	44

## ELECTRONIC PIPETTES

StarPet E Single & Multi-Channel Pipettes .....	45
---	----

## PIPETTE CONTROLLERS

StarPet Pro Cordless Controller .....	46
StarPet Safety Filler .....	46
StarPet Filler .....	46

## SEROLOGICAL PIPETTES

Polystyrene Pipettes .....	47
----------------------------	----

## REPEAT DISPENSER

RepeatOne® Dispenser .....	48
----------------------------	----

# ErgoOne® Pipettes Overview

## ErgoOne

### Setting the new standard in pipetting

Everyday, pipettes are confronted with multiple tasks that must be exact and precise. Reliability is key in the laboratory and your pipette must be trusted to perform well, day in, day out.

As one of the most frequently used instruments in the laboratory, pipettes must also be comfortable to use and provide the features you need. ErgoOne® pipettes combine researcher-requested features with the latest ergonomic principles to provide optimum performance. ErgoOne® gives

you accuracy and precision you can trust, with a stylish new look you will love.

Lightweight and extremely easy to use, ErgoOne® can be trusted to provide accurate and precise pipetting all day, every day. Use with STARLAB's TipOne® pipette tips for the perfect pipetting partnership.

ErgoOne® is designed to fit all popular pipettes without any loss of accuracy and precision.

### Features

- Minimal operating forces
- Lightweight ergonomic design
- Colour coded
- Volume lock
- Fully autoclavable
- UV-resistant
- Low maintenance
- Made in Germany
- 3-year warranty

**Easily removable lower part for fast cleaning**

**Wear-resistant polymer tip holders**

**Tip ejector**  
with integrated cascade to lower the tip ejection force





**Colour coding**

**Volume lock**

Prevents drift during use

**Ergonomically designed**

Finger rest ensures comfort and ease during use.

**Smooth action tip ejector**

**Contoured chemically-resistant PP handle**



**Lightweight**

**Volume display**

Positioned so it is visible during pipetting

4-digit volume display for greater accuracy

**Fully autoclavable**

Can also be UV sterilised

**Three-year warranty**

**Easily removable tip ejector for fast cleaning**

**CE Marked for IVD**

**Universal tip fit!**

**ErgoOne**

*Setting the new standard in pipetting*

**Reduced diameter tip ejector**

For easy access into small tubes

**Integral, rust-free tip ejector**



# ErgoOne® Single-Channel Pipettes



ErgoOne® Single-Channel Pipettes							
Cat. No.	Volume Range (Colour Coding)	Volume $\mu$ l	Systematic Error (Inaccuracy) $\pm\%$		Random Error (Imprecision) $\pm\%$		Price
			8655-2	ErgoOne	8655-2	ErgoOne	
<b>Single-Channel</b>							
S7100-0125	0.1 – 2.5 $\mu$ l (Red)	0.1	125	24	75	12	£194.78
		1.25	10	2.5	6.0	1.5	
		2.5	5.0	1.4	3.0	0.7	
S7100-0510	0.5 – 10 $\mu$ l (Red)	1.0	12	2.5	8.0	1.8	£194.78
		5	2.4	1.5	1.6	0.8	
		10	1.2	1.0	0.8	0.4	
S7100-0221 (micro cone)	2 – 20 $\mu$ l (Red)	2	10	5.0	5.0	1.5	£178.08
		10	2.0	1.2	1.0	0.6	
		20	1.0	1.0	0.5	0.3	
S7100-0220 (standard cone)	2 – 20 $\mu$ l (Yellow)	2	10	5.0	5.0	1.5	£178.08
		10	2.0	1.2	1.0	0.6	
		20	1.0	1.0	0.5	0.3	
S7100-1100	10 – 100 $\mu$ l (Yellow)	10	8.0	3.0	3.0	1.0	£178.08
		50	1.6	1.0	0.6	0.3	
		100	0.8	0.8	0.3	0.2	
S7100-2200	20 – 200 $\mu$ l (Yellow)	20	8.0	2.5	3.0	0.7	£178.08
		100	1.6	1.0	0.6	0.3	
		200	0.8	0.6	0.3	0.2	
S7110-1000	100 – 1000 $\mu$ l (Blue)	100	8.0	3.0	3.0	0.6	£178.08
		500	1.6	1.0	0.6	0.2	
		1000	0.8	0.6	0.3	0.2	
S7150-5000	500 – 5000 $\mu$ l (Violet)	500	8.0	2.4	3.0	0.6	£194.78
		2500	1.6	1.2	0.6	0.25	
		5000	0.8	0.6	0.3	0.15	

Tested in accordance with EN ISO 8655, using STARLAB's TipOne® tips.

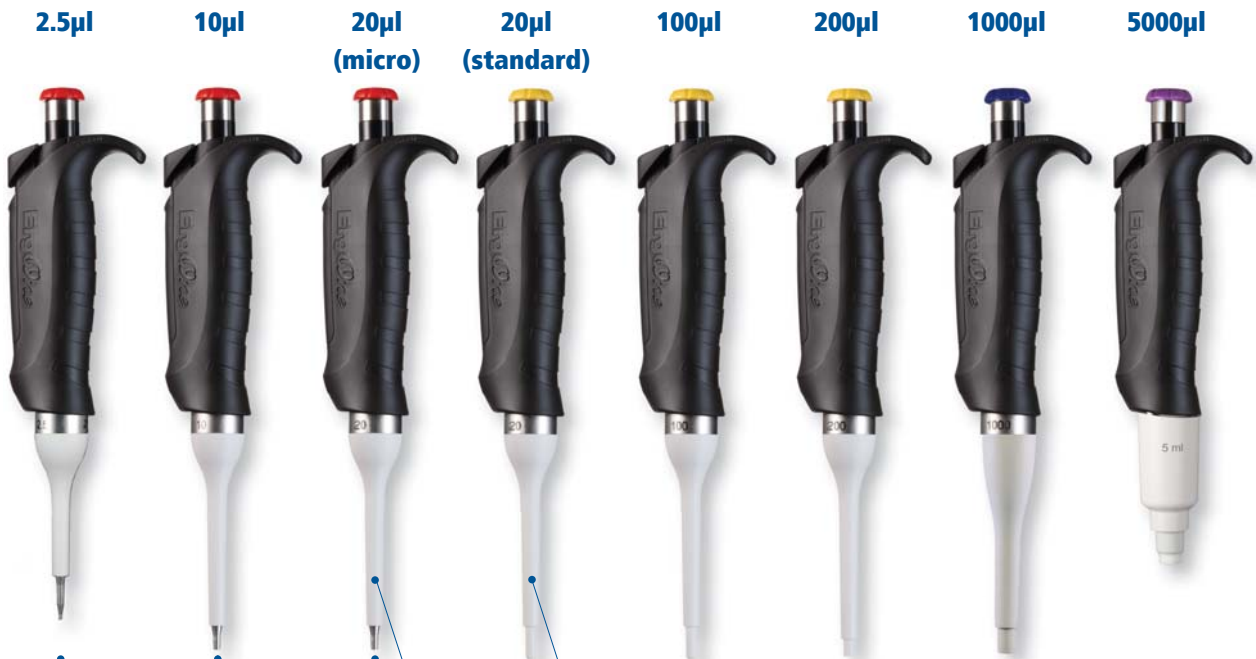

Stainless Steel tip holders on micro models

20  $\mu$ l micro model for use with micro tips, eg. TipOne® 10  $\mu$ l XL Graduated Tip, Max. Vol 20  $\mu$ l

20  $\mu$ l standard model for use with, for eg. TipOne® 200  $\mu$ l tip ranges

# ErgoOne® Multi-Channel Pipettes



ErgoOne® Multi-Channel Pipettes							
Cat. No.	Volume Range (Colour Coding)	Volume $\mu$ l	Systematic Error (Inaccuracy) $\pm\%$		Random Error (Imprecision) $\pm\%$		Price
			8655-2	ErgoOne	8655-2	ErgoOne	
<b>8-Channel Pipettes</b>							
S7108-0510	0.5 –10 $\mu$ l (Red)	1.0	24	8.0	16	5.0	£500.85
		5.0	4.8	4.0	3.2	2.0	
		10	2.4	2.0	1.6	1.0	
S7108-1100	10 –100 $\mu$ l (Yellow)	10	32	3.0	12	2.0	£500.85
		50	16	1.0	6.0	0.8	
		100	3.2	0.8	1.2	0.3	
S7108-3300	30 –300 $\mu$ l (Green)	30	26.7	3.0	10	1.0	£500.85
		150	5.3	1.0	2.0	0.5	
		300	2.7	0.6	1.0	0.3	
<b>12-Channel Pipettes</b>							
S7112-0510	0.5 –10 $\mu$ l (Red)	1.0	24	8.0	16	5.0	£595.46
		5.0	4.8	4.0	3.2	2.0	
		10	2.4	2.0	1.6	1.0	
S7112-1100	10 –100 $\mu$ l (Yellow)	10	32	3.0	12	2.0	£595.46
		50	16	1.0	6.0	0.8	
		100	3.2	0.8	1.2	0.3	
S7112-3300	30 –300 $\mu$ l (Green)	30	26.7	3.0	10	1.0	£595.46
		150	5.3	1.0	2.0	0.5	
		300	2.7	0.6	1.0	0.3	

Tested in accordance with EN ISO 8655, using STARLAB's TipOne® tips.



## Pipette Stands

Pipette Stands			
Cat. No.	Description	Colour	Price
S7200-0000	ErgoOne® Universal Carousel Stand for up to 8 Pipettes	Black/Silver	£83.48
E3099-0000	UV Resistant Universal Acrylic Stand for up to 5 Pipettes	Yellow	£38.96
E3099-0001	ErgoOne® Self-Adhesive Shelf Holder for 1 Pipette	Yellow	£5.04
G8965-8000	UV Resistant Universal Rotary Stand for Six Pipettes	Grey	£64.48

### Compatibility:

- S7200-0000 Use with ErgoOne®, Biohit®, Finn®, Gilson®, Rainin®
- E3099-0000 Use with ErgoOne®, Biohit®, Finn®, Eppendorf®, Gilson®, Rainin®
- E3099-0001 Use with ErgoOne®
- G8965-8000 Use with Eppendorf®, Gilson®, Rainin® and StarPet

NOTE: For stands for use with CAPP® multi-channel pipettes and StarPet E electronic pipettes, see pages 44 and 45 respectively.

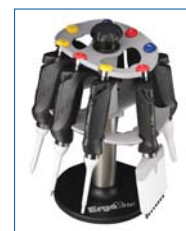

S7200-0000



E3099-0000



E3099-0001



G8965-8000

# CAPP® Multi-Channel Pipettes

## High throughput pipetting!

CAPP® pipettes are supplied with variable volume controls which are colour-coded for ease of selection. Fixed volume controls can also be purchased separately, allowing you to convert your pipette (within its specified volume range) to a fixed-volume pipette. The fixed-volume controls are available at a substantially lower cost than buying a standard fixed-volume pipette.



## Features

- Colour-coded volume controls for ease of selection
- Volume lock to prevent drift
- Dual O-rings for precise tip fit – every time!
- Fully autoclavable (except volume control)
- Soft rubber-coated handle (except 48- and 64-channel pipettes)
- Compatible with STARLAB's TipOne® tips (see pages 12–17)
- 3-year warranty



64-channel CAPP® pipette

For 384-format tips for use with the 16-, 48- or 64-channel pipettes, see page 18.



E8800-0500



E8800-0600

## CAPP® Multi-Channel Pipettes

Cat. No.	Volume Range	Colour Coding	± AC*(%)	≤ CV**(%)	Price
<b>8-Channel</b>					
SL10-8AZ	0.5–10µl	White	5.00 / 2.32 / 2.00	3.60 / 1.28 / 1.00	£439.64
SL50-8AZ	5–50µl	Red	3.20 / 1.60 / 1.40	1.60 / 0.72 / 0.60	£383.99
SL200-8AZ	20–200µl	Yellow	1.80 / 1.44 / 1.20	0.80 / 0.44 / 0.40	£383.99
SL300-8AZ	30–300µl	Black	1.66 / 1.44 / 1.20 1.40 / 1.40 / 1.40	0.60 / 0.44 / 0.40 0.44 / 0.36 / 0.30	£383.99
<b>12-Channel</b>					
SL10-12AZ	0.5–10µl	White	5.00 / 2.32 / 2.00	3.60 / 1.28 / 1.00	£484.16
SL50-12AZ	5–50µl	Red	3.20 / 1.60 / 1.40	1.60 / 0.72 / 0.60	£428.51
SL200-12AZ	20–200µl	Yellow	1.80 / 1.44 / 1.20	0.80 / 0.44 / 0.40	£428.51
SL300-12AZ	30–300µl	Black	1.66 / 1.44 / 1.20 1.40 / 1.40 / 1.40	0.60 / 0.44 / 0.40 0.44 / 0.36 / 0.30	£428.51
<b>16-Channel</b>					
SL02-16AZ	0.2–2µl	Violet	24.00 / 6.20 / 4.00	12.00 / 3.20 / 2.00	£606.59
SL10-16AZ	0.5–10µl	White	5.00 / 2.32 / 2.00	3.60 / 1.28 / 1.00	£606.59
SL50-16AZ	5–50µl	Red	3.20 / 1.60 / 1.40	1.60 / 0.72 / 0.60	£606.59
<b>48-Channel</b>					
C-10-48	0.5–10µl	White	10.00 / 4.64 / 4.00	7.20 / 2.56 / 2.00	£1196.48
<b>64-Channel</b>					
C-10-64	0.5–10µl	White	10.00 / 4.64 / 4.00	7.20 / 2.56 / 2.00	£1252.13

\*Maximum Systematic Error (ISO 8655). \*\*Maximum Random Error (ISO 8655). Measured at min, mid-point and max volumes. NOTES: min. volume measured on 0.5–10µl model is 1µl. Two readings are given for the 30–300µl models to cover the two variable control knobs supplied: one 30–200µl and one 150–300µl.

## CAPP® Accessories

Cat. No.	Description	Colour	Price
SL02-FZ-2	2µl Fixed-Volume Control	Violet	£15.54
SL10-FZ-10	10µl Fixed-Volume Control	White	£15.54
SL50-FZ-50	50µl Fixed-Volume Control	Red	£15.54
SL200-FZ-200	200µl Fixed-Volume Control	Yellow	£15.54
SL300-FZ-300	300µl Fixed-Volume Control	Black	£15.54
E8800-0500	Stand for 1 CAPP® Multi-Channel Pipette	Grey	£32.24
E8800-0600	Carousel Stand for 3 CAPP® Multi-Channel Pipettes	Black/Silver	£53.45

NOTE: Volume controls are not autoclavable and should be removed prior to autoclaving the pipette.



# StarPet E Electronic Pipettes

## StarPet E



### Features

- Easy to use
- Lightweight, ergonomic design
- Excellent accuracy and precision
- Precise volume setting
- Five aspirating/dispensing speeds
- Auto calibration
- Fully motorised piston drive virtually eliminates pipetting force
- Auto memory of last-used pipetting protocol/settings
- Store up to nine sets of operating parameters for instant recall
- Autoclavable lower manifold
- Long lasting, rechargeable Li-ion battery that lasts for up to 40 hours of normal use
- Can be charged during use
- Compatible with STARLAB's TipOne® tips (see pages 12–17)
- Shelf pipette holder included with every pipette

### So easy to use!

StarPet E single and multi-channel electronic pipettes are lightweight and easy to use. These multi-functional pipettes have operating modes for standard and reverse pipetting as well as multiple and sequential pipetting, mixing of samples and serial dilutions. All functions can be easily programmed using one hand on the easy to reach, easy to use keypad.

StarPet E Electronic Pipettes					
Cat. No.	Volume Range	Increments	AC*(%)	CV**(%)	Price
<b>Single-Channel</b>					
G9900-0010	0.5–10µl	0.1µl	±4.0 to ±1.0	≤2.5 to ≤0.4	£228.17
G9900-0020	2–20µl	0.1µl	±4.0 to ±1.0	≤2.5 to ≤0.4	£228.17
G9900-0200	10–200µl	1.0µl	±2.5 to ±0.6	≤1.0 to ≤0.15	£228.17
G9900-1200	100–1200µl	1.0µl	±2.5 to ±0.5	≤0.6 to ≤0.15	£228.17
<b>8-Channel</b>					
G9908-0010	0.5–10µl	0.1µl	±4.0 to ±1.5	≤2.5 to ≤0.5	£456.33
G9908-0020	2–20µl	0.1µl	±4.0 to ±1.0	≤2.5 to ≤0.5	£456.33
G9908-0200	10–200µl	1.0µl	±3.0 to ±0.6	≤1.0 to ≤0.15	£456.33
G9908-1200	100–1200µl	1.0µl	±3.0 to ±0.5	≤0.8 to ≤0.2	£517.55
<b>12-Channel</b>					
G9912-0010	0.5–10µl	0.1µl	±4.0 to ±1.5	≤2.5 to ≤0.5	£534.24
G9912-0020	2–20µl	0.1µl	±4.0 to ±1.0	≤2.5 to ≤0.5	£534.24
G9912-0200	10–200µl	1.0µl	±3.0 to ±0.6	≤1.0 to ≤0.15	£534.24
G9912-1200	100–1200µl	1.0µl	±3.0 to ±0.5	≤0.8 to ≤0.2	£595.46

All pipettes are supplied with one Li-ion battery, an AC-DC power supply, and a self-adhesive pipette holder.

\*Maximum Systematic Error (ISO 8655). \*\*Maximum Random Error (ISO 8655).

NOTE: Lowest testing on 0.5–10µl pipettes is at 1µl, not 0.5µl

StarPet E Accessories		
Cat. No.	Description	Price
G9999-0006	Li-ion Battery for StarPet E	£25.62
G9999-0003	Acrylic stand (holds up to 3 pipettes)	£53.45

**DEMO MODELS**  
**TRY**  
 before you  
**BUY**  
 available on request



# Pipette Controllers

StarPet PRO



## Cordless pipette controller

- One of the fastest controllers on the market!  
Fills a 25ml pipette <3 seconds.
- Use with all plastic or glass pipettes, 1ml to 100ml
- Two aspirate and dispense speeds
- Gravity dispense mode for use with 'To Deliver' (TD) pipettes
- Can be recharged during use
- Autoclavable and replaceable silicone pipette holder
- 4 hours continuous use from a fully-charged battery
- 'Low battery' indicator light



The unique stand can be used on the bench or mounted on a wall

### StarPet Pro Specifications

Batteries	2 x 1.2V nickel metal hydride
Charger	75 mAh for 14 hours
Weight	180g (without stand/wall bracket)
Filter	Hydrophobic 0.45µm or 0.2µm
Materials	Case & Nosecone: ASA Pipette Holder: Silicone
Voltage	100V –240V, 50–60Hz
Supplied with	Charger, Stand, 1 x 0.2µm filter, and 1 x 0.45µm filter ready fitted

### StarPet Pro Cordless Controller

Cat. No.	Description	Pack Size	Price
E4866-0021	StarPet Pro Cordless Pipette Controller	1	£244.86
E4266-0050	Replacement Charger	1	£56.81
P2131-0002	ASA Nosecone (White)	1	£19.43
E4266-0890	0.2µm Filter (White)	5	£32.24
E4266-0030	0.45µm Filter (Blue)	5	£33.92
E4266-0040	Silicone Pipette Holder	1	£21.74



## StarPet safety filler

For use with 1–100ml plastic or glass pipettes. Simple thumb button operation. Autoclavable and replaceable silicone pipette holder. Supplied with a 0.45µm filter and four different colour pipette cones (white, pink, violet, green) to aid safety colour-coding



### StarPet Safety Filler

Cat. No.	Description	Pack Size	Price
E4866-1000	StarPet Safety Filler	1	£59.01
E4266-0890	0.2µm Filter (White)	5	£32.24
E4266-0030	0.45µm Filter (Blue)	5	£33.92
E4266-0040	Silicone Pipette Holder	1	£21.74



## StarPet filler

Use with 1–25ml plastic or glass pipettes. Two dispense resolutions: one delivers fast filling with optimal accuracy for 10ml to 25ml pipettes, the other is for use with 1–10ml pipettes where accuracy can sometimes be difficult to control. Compatible with Blow-Out 'To Deliver' (TD) or gravity dispense pipettes. Autoclavable and replaceable silicone pipette holder

### StarPet Filler

Cat. No.	Description	Pack Size	Price
E4866-2000	StarPet Filler	1	£26.67
E4266-0040	Silicone Pipette Holder	1	£21.74



# Polystyrene Pipettes

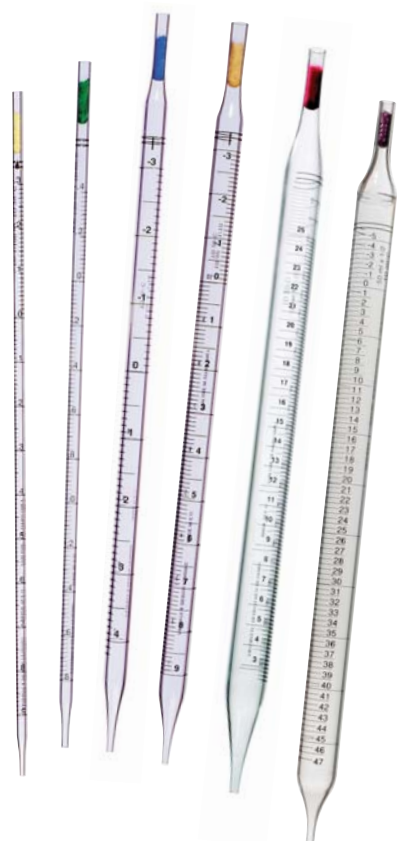

## Clearly a quality pipette!

Perfect for use with all popular pipette controllers, including STARLAB's own range opposite, these serological pipettes are made from crystal polystyrene with a seamless construction to eliminate hangup and provide more accuracy. Available in two styles: non-sterile in economical bulk bags (ideal for western blotting!), or individually-wrapped sterile pipettes featuring colour-coded plug filters that conform to the international standard.

## Features

- Accuracy >98%
- Sterile pipettes have colour-coded plugs for ease of selection
- Crisp, black, raised permanent graduations
- Ascending and descending graduations on pipettes 5ml and over
- Lot No. of every pipette printed on sterile, individual wrapping
- ISO 9001:2000 manufactured
- Certified non-cytotoxic, non-haemolytic and pyrogen free

Serological Pipettes			
Cat. No.	Description	Pack Size	Price
<b>Bulk, Non-Sterile</b>			
E4860-0100	1.0ml Serological Pipette, Bulk	8 x 250	£151.41
E4860-0200	2.0ml Serological Pipette, Bulk	4 x 250	£83.48
E4860-0500	5.0ml Serological Pipette, Bulk	2 x 200	£60.06
E4860-1000	10ml Serological Pipette, Bulk	2 x 125	£41.16
E4860-2500	25ml Serological Pipette, Bulk	2 x 50	£44.52
<b>Individually-Wrapped, Sterile</b>			
E4860-0111	1.0ml Serological Pipette, Yellow Filter, (Sterile), Ind. Wrapped	500	£61.22
E4860-0211	2.0ml Serological Pipette, Green Filter (Sterile), Ind. Wrapped	500	£64.58
E4860-0511	5.0ml Serological Pipette, Blue Filter (Sterile), Ind. Wrapped	250	£53.45
E4860-1011	10ml Serological Pipette, Orange Filter (Sterile), Ind. Wrapped	200	£46.73
E4860-2511	25ml Serological Pipette, Red Filter (Sterile), Ind. Wrapped	100	£64.58
E4860-5012-C	50ml Serological Pipette, Violet Filter (Sterile), Ind. Wrapped	200	£218.89

Serological Pipette Specifications				
Pipette Volume	Plug Colour*	Increments	Extra Graduations	Total Volume
1ml	Yellow	0.01ml	0.3ml	1.3ml
2ml	Green	0.02ml	0.4ml	2.4ml
5ml	Blue	0.1ml	3.0ml	8.0ml
10ml	Orange	0.1ml	3.0ml	13.0ml
25ml	Red	0.2ml	2.6ml	27.6ml
50ml	Violet	0.5ml	10.0ml	60.0ml

\*Sterile serological pipettes only.



## Colour-coded packaging

(Sterile, individual wrap pipettes only)

- Closable, stackable, and space-saving
- Colour-coded
- Clearly visible bar codes
- Lot No. printed on every individual pipette wrapper



## 2.0ml aspiration pipette

Sterile, polystyrene pipette without a filter or graduations. One piece construction. Aspiration pipettes are used for vacuum aspirating procedures or transfers of fluids where accuracy is not a requirement.

Aspiration Pipette			
Cat. No.	Description	Pack Size	Price
E4860-1211	2.0ml Aspiration Pipette (Sterile), Ind. Wrapped	500	£54.50

# RepeatOne® Dispenser

## Rapid dispensing!

RepeatOne® is a hand-held device for repetitive and rapid dispensing of volumes 10µl to 5ml. Up to 48 pipettings of the same sample can be made without refilling, resulting in a considerable reduction in time and expense. RepeatOne® allows the selection of five separate volumes from each TipOne® Repeat dispenser tip.

**DEMO MODELS**  
**TRY**  
before you  
**BUY**  
available on request



RepeatOne®

## Features

- Up to 48 dispenses from the same sample
- Locking clamp holds the dispenser tip securely in place
- Conforms to EN ISO 8655 Piston-Operated Volumetric Apparatus
- Conforms to ASTM E1154-89 (2003) Standard Specification for Piston or Plunger Operated Volumetric Apparatus
- Conforms to 98/79/EEC In Vitro Diagnostic Medical Devices
- 2-year warranty

RepeatOne® Dispenser		
Cat. No.	Description	Price
S4026-1500	RepeatOne® Dispenser (includes Adapter for 25ml and 50ml Dispenser Tips)	£200.34
S4026-1525	Replacement Adapter for 25ml and 50ml Dispenser Tips	£4.83

Technical Data									
TipOne® Repeat Size	Dispensing Volume			Systematic Error (Inaccuracy)			Random Error (Imprecision; CV)		
	Min.		Max.	Min.		Max.	Min.		Max.
0.5ml	10µl	30µl	50µl	±2.0%	±1.0%	±1.0%	±2.0%	±1.0%	±0.8%
1.25ml	25µl	75µl	125µl	±0.9%	±0.9%	±0.9%	±0.9%	±0.7%	±0.6%
2.5ml	50µl	150µl	250µl	±0.7%	±0.7%	±0.7%	±0.9%	±0.7%	±0.6%
5ml	100µl	300µl	500µl	±0.6%	±0.6%	±0.6%	±0.6%	±0.5%	±0.3%
12.5ml	250µl	750µl	1250µl	±0.5%	±0.5%	±0.5%	±0.6%	±0.5%	±0.3%
25ml	500µl	1500µl	2500µl	±0.4%	±0.4%	±0.4%	±0.6%	±0.4%	±0.25%
50ml	1000µl	3000µl	5000µl	±0.3%	±0.3%	±0.3%	±0.5%	±0.4%	±0.25%

## Dispenser Tips

See page 24 for ordering details of STARLAB's TipOne® Repeat Dispenser Tips.



## Compatibility

The RepeatOne® dispenser can be used with the following dispenser tips:

- STARLAB TipOne® Repeat (see page 24)
- Brand®
- Eppendorf®
- Gilson®
- HTL®
- Ritter®

## Test Conditions in Accordance with EN ISO 8655

Liquid	Water bi-distilled, degassed
Test Temperature	20–25°C, ±0.5°C constant (Data for TipOne® Repeat 0.5ml, 1.25ml and 2.5ml are determined with attached 200µl pipette tip)
Operating Temperature	+4°C to +40°C
Measurement	Performed with original TipOne® Repeat dispenser tips in accordance with EN ISO 8655



# *Pipette Servicing*

## **PIPETTE SERVICING**

Calibration & Repair Service Overview ..... 50–52

## **SERVICE LEVELS**

Standard Servicing & Calibration ..... 53

UKAS Servicing & Calibration ..... 54

## **PIPETTE SPARES**

For ErgoOne® Pipettes ..... 55

For Gilson® Pipettes ..... 56

# Calibration & Repair Service Overview



## For accuracy to the last drop!

Our team of fully-trained technicians can service all brands of pipettes: single and multi-channel, manual and electronic, repeaters, pipette controllers and bottle-top dispensers, and will ensure the accuracy of your pipette to the last drop.

Our state of the art calibration laboratory is UKAS accredited. All our balances and weights are calibrated annually as part of the UKAS accreditation. As a UKAS accredited laboratory, you can be sure that all STARLAB staff are competent and fully-trained, that our instruments are calibrated and properly maintained, and our servicing is carried out in the correct conditions. UKAS is an internationally recognised standard which ensures full traceability of data and requires both internal and external quality control. The same balances and weights are used for both UKAS and non-UKAS calibrations.

Pipettes requiring servicing can either be mailed-in to our laboratory or we can come to you and service at your premises.

## Service and calibration levels

See pages 53–54 for details of our servicing levels. Should one of these options not suit your requirements, contact us for a customised servicing quote.

## Custom servicing

We can service pipettes to your exact requirements. You choose the number of readings per channel and the test points to suit. Just let us know exactly what you need and we'll give you a competitive quote.

## Customer services

STARLAB prides itself on being an innovative, customer-focused company and this is reflected by the service we offer, as standard

- Replacement parts and servicing is guaranteed for 6 months
- Customised invoicing to suit your institution's requirements (eg. breakdown your invoices by department, grant code or name)
- No hidden costs! We will always contact you beforehand if any major parts need replacing

# Caltech



## Mail-in servicing

- Convenient service, when you need it
- Free, postage-paid mail-in bags and packing boxes to send us your pipettes
- Quick turnaround
- Free return postage via courier

## On-site servicing

- Low minimum of 25 pipettes, or day rate available
- Minimises pipette 'down time' for end-users
- Convenient when the whole lab needs their pipettes servicing
- Each on-site service is tailored to suit individual requirements
- Provision of daily, weekly or end of clinic reports (depending on the length of the clinic) listing all the pipettes serviced by serial number, the service level carried out, and any parts fitted
- Pre- and post-clinic consultations to ensure everything runs smoothly



4296

# Calibration & Repair Service Overview

## CaliStar calibration software

STARLAB has launched its own bespoke calibration software CaliStar, which incorporates 2D barcoding technology. This innovative new piece of software has been designed by STARLAB to improve the efficiency of our pipette service as a whole. The software greatly reduces repetitive recording of serial numbers and other administrative tasks, minimises errors and greatly speeds up the administrative tasks involved.

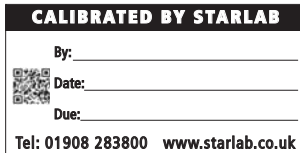

The 2D barcode is on the calibration label we put onto the pipettes. The barcode is scanned, and this enables us to track each pipette from the moment it arrives at our lab or at a clinic, through servicing and calibration, to out the door and beyond.

The CaliStar software has also enhanced the information we can give to our customers. The software tracks the service status of each pipette, the spares used, the service level carried out and the calibration results, as well as generating electronic signatures for certificates to enable the whole process to be fully paperless (although certificates can still be printed if preferred). The software is fully integrated with our back-office system in order to generate bespoke invoicing requirements too.

## Pipette service history

- CaliStar allows us to provide the service history of an individual pipette, what it is costing to maintain over a period of time and how it is performing. Over subsequent years, these reports will allow customers to identify any pipettes requiring frequent and/or expensive repairs

## Asset management lists

- We can provide you with a list of pipettes belonging to a lab, a group or an institution for your own asset management purposes

The STARLAB system has the advantage over the new pipettes coming onto the market with RFID (Radio Frequency ID). With RFID, it is only those pipettes with that function that can be tracked and their history stored for asset management purposes. CaliStar gives any pipette, however old, the benefit of these features.



Service Report - Example

Item	Sold-to-party	Material	HL itm	Order Quantity	PO Details	PO Number	Receiving point	Amount	WorkOrder Number	Company Name	Department	Manufacturer	Model	Part Description	Status	Test Plan	Comment
1					1 065821L	PO 100001	John Smith		EXAMPLE1	Your Company Name Here	Dept. 1	Gilson	Pipetman		Complete	2 Star 3 Reading	
2					1 R67882L	PO 100001	John Smith		EXAMPLE1	Your Company Name Here	Dept. 1	Gilson	Pipetman		Complete	2 Star 3 Reading	
3					1 U65779L	PO 100001	John Smith		EXAMPLE1	Your Company Name Here	Dept. 1	Gilson	Pipetman		Complete	2 Star 3 Reading	
4					1 W53638A	PO 100001	John Smith		EXAMPLE1	Your Company Name Here	Dept. 1	Gilson	Pipetman		Complete	UKAS 10 Reading	
5					1 T55489C	PO 100001	John Smith		EXAMPLE1	Your Company Name Here	Dept. 1	Gilson	Pipetman		Complete	UKAS 10 Reading	
6					1 N14977C	PO 100001	John Smith		EXAMPLE1	Your Company Name Here	Dept. 1	Gilson	Pipetman		Complete	UKAS 10 Reading	
7					1 G53407L	PO 100001	John Smith		EXAMPLE1	Your Company Name Here	Dept. 1	Gilson	Pipetman		Complete	2 Star 3 Reading	
8					1 DH1	PO 100001	John Smith		EXAMPLE1	Your Company Name Here	Dept. 1	Gilson	Pipetman		Returned	2 Star 3 Reading	
9					1 W73334L	PO 100001	John Smith		EXAMPLE1	Your Company Name Here	Dept. 1	Gilson	Pipetman		Complete	2 Star 3 Reading	
10					1 Q57141A	PO 100001	John Smith		EXAMPLE1	Your Company Name Here	Dept. 1	Gilson	Pipetman		Complete	2 Star 3 Reading	
11					1 N50004J	PO 100001	John Smith		EXAMPLE1	Your Company Name Here	Dept. 1	Gilson	Pipetman		Complete	2 Star 3 Reading	
12		SLP1112-0201		11	1 N50004J	PO 100001	John Smith		EXAMPLE1	Your Company Name Here	Dept. 1	Gilson	Pipetman	P20 Seal	Complete	2 Star 3 Reading	
13		SLP1122-0201		11	1 N50004J	PO 100001	John Smith		EXAMPLE1	Your Company Name Here	Dept. 1	Gilson	Pipetman	P20 O Ring	Complete	2 Star 3 Reading	
14		SLP1132-0201		11	1 N50004J	PO 100001	John Smith		EXAMPLE1	Your Company Name Here	Dept. 1	Gilson	Pipetman	P20 Tip Holder	Complete	2 Star 3 Reading	
15					1 M21318M	PO 100001	John Smith		EXAMPLE1	Your Company Name Here	Dept. 1	Gilson	Pipetman		Complete	2 Star 3 Reading	
16					1 Q22373E	PO 100001	John Smith		EXAMPLE1	Your Company Name Here	Dept. 1	Gilson	Pipetman		Complete	2 Star 3 Reading	
17					1 248460	PO 100002	Ann Jones		EXAMPLE1	Your Company Name Here	Dept. 2	Eppendorf	Research		Returned	2 Star 3 Reading	
18					1 2086031	PO 100002	Ann Jones		EXAMPLE1	Your Company Name Here	Dept. 2	Eppendorf	Research		Complete	2 Star 3 Reading	
19					1 4621211	PO 100002	Ann Jones		EXAMPLE1	Your Company Name Here	Dept. 2	Eppendorf	Research		Complete	2 Star 3 Reading	
20					1 T50319B	PO 100002	Ann Jones		EXAMPLE1	Your Company Name Here	Dept. 2	Gilson	Pipetman		Complete	2 Star 3 Reading	
21					1 R57850N	PO 100002	Ann Jones		EXAMPLE1	Your Company Name Here	Dept. 2	Gilson	Pipetman		Complete	2 Star 3 Reading	
22					1 M26380C	PO 100002	Ann Jones		EXAMPLE1	Your Company Name Here	Dept. 2	Gilson	Pipetman		Complete	2 Star 3 Reading	
23					1 N60177H	PO 100003	David Andrews		EXAMPLE1	Your Company Name Here	Dept. 3	Gilson	Pipetman		Complete	2 Star 3 Reading	
24					1 N60177H	PO 100003	David Andrews		EXAMPLE1	Your Company Name Here	Dept. 3	Gilson	Pipetman	P10 Seal	Complete	2 Star 3 Reading	
25		SLP1112-0101		23	1 N60177H	PO 100003	David Andrews		EXAMPLE1	Your Company Name Here	Dept. 3	Gilson	Pipetman	P2/P10 O Ring	Complete	2 Star 3 Reading	
26		SLP1132-0101		23	1 N60177H	PO 100003	David Andrews		EXAMPLE1	Your Company Name Here	Dept. 3	Gilson	Pipetman	P10 Tip Holder	Complete	2 Star 3 Reading	
27					1 R71179N	PO 100003	David Andrews		EXAMPLE1	Your Company Name Here	Dept. 3	Gilson	Pipetman		Complete	2 Star 3 Reading	
28					1 T80765G	PO 100003	David Andrews		EXAMPLE1	Your Company Name Here	Dept. 3	Gilson	Pipetman		Complete	2 Star 3 Reading	
29		SLP1112-1501		28	1 T80765G	PO 100003	David Andrews		EXAMPLE1	Your Company Name Here	Dept. 3	Gilson	Pipetman	P5000 Seal	Complete	2 Star 3 Reading	
30		SLP1122-1501		28	1 T80765G	PO 100003	David Andrews		EXAMPLE1	Your Company Name Here	Dept. 3	Gilson	Pipetman	P5000 O Ring	Complete	2 Star 3 Reading	

STARLAB's bespoke CaliStar software generates quick and accurate reporting of on-site clinic activity

# Calibration & Repair Service Overview

## Certificates on USB

Calibration certificates for clinics are supplied in PDF format on USB memory sticks so you can save the files onto your own computer for safe keeping. Paper copies of certificates can be provided if required.



## Instant UKAS certificates

STARLAB uses electronic signatures on certificates for UKAS calibrations. This means we can give you your certificates on USB memory stick at the end of the clinic and there is no delay waiting for the counter signature.

## How to organise an on-site pipette clinic

Contact your Account Manager, or the Servicing Coordinator at the STARLAB office at [caltech@pipettes.co.uk](mailto:caltech@pipettes.co.uk) or phone 01908 283800. If it is your first clinic with us we will arrange a pre-clinic consultation to ensure that any specific requirements you have are known and to ensure your proposed location for the clinic is suitable – we require three meters of vibration-free bench space in a draft-free environment. STARLAB will provide marketing material to help promote the clinic for you and provide you with decontamination forms and information on decontamination procedures. You can sit back and relax while we do the work.

## How to send us your pipettes for servicing

Simply decontaminate your pipette, complete a decontamination declaration and package your pipette securely to avoid damage during transit. Postage is free too! Contact your Account Manager or the STARLAB office to obtain a pre-paid postage label by email. We will service and calibrate your pipette and return the pipette and calibration certificate to you via courier.

## Pipette training sessions and seminars

STARLAB can hold small-group sessions at your premises on general pipette maintenance and good pipetting techniques. These workshops have proved to cut the cost of repairs in the long term as end-users are trained in good pipetting practice and basic maintenance.

## IMPORTANT! ALL PIPETTES MUST BE DECONTAMINATED BEFORE SERVICING

ALL pipettes for servicing must be decontaminated and accompanied by a Decontamination Declaration so we know they are safe for us to work on. We can not service or calibrate a pipette without a completed and signed declaration.

STARLAB recommends using Distel® High Level Laboratory Disinfectant (page 140) to decontaminate your pipettes. Contact us for a copy of the Decontamination Declaration form and a copy of the Data Sheet on using Distel® to decontaminate pipettes. Alternatively, both the form and data sheet can be downloaded from [www.pipettes.co.uk](http://www.pipettes.co.uk)

Please also ensure your pipettes are completely dry before presenting them for servicing at a pipette clinic or before packaging them to mail in to our laboratory.



# Standard Servicing & Calibration

		QuickCal*	1-STAR Service	2-STAR Service	3-STAR Service
SERVICE	Pipette dismantled, inspected, leak tested, worn parts replaced	✓	✓	✓	✓
	Internal Clean	✓	✓	✓	✓
	External Clean	✗	✓	✓	✓
CALIBRATE	Single-Channel	3 readings at mid-point	4 readings at mid-point	3 readings at min and max points	4 readings at min, mid and max points
	8-Channel	Visual check across all 8 channels. 3 readings on a middle channel, at mid-point	2 readings on each of the 8 channels, at mid point	2 readings on each of the 8 channels, at min and max points	2 readings on each of the 8 channels, at min, mid and max points
	12-Channel	Visual check across all 12 channels. 3 readings on a middle channel, at mid-point	2 readings on each of the 12 channels, at mid point	2 readings on each of the 12 channels, at min and max points	2 readings on each of the 12 channels, at min, mid and max points
	16-Channel	Visual check across all 16 channels. 3 readings on a middle channel, at mid-point	2 readings on each of the 16 channels, at mid point	2 readings on each of the 16 channels, at min and max points	2 readings on each of the 16 channels, at min, mid and max points
	Calibration Certificate for each pipette	✗	✓	✓	✓
	Batch Certificate	✓	✗	✗	✗
TIME	48-Hour Turn-Around	✓	✓	✓	✓
AS FOUND	Single-Channel	n/a	£9.00	£10.00	£11.00
	8-Channel	n/a	£13.50	£16.00	£21.00
	12-Channel	n/a	£16.00	£18.50	£23.50
	16-Channel	n/a	£18.50	£21.00	£26.00
SERVICE & CALIBRATION	Single-Channel	£8.50	£18.00	£20.00	£22.00
	8-Channel	£10.50	£27.00	£32.00	£42.00
	12-Channel	£12.50	£32.00	£37.00	£47.00
	16-Channel	£14.50	£37.00	£42.00	£52.00
	Repeat Dispenser	£8.50	£18.00	£20.00	£22.00
	Bottle-Top Dispenser	£8.50	£18.00	£20.00	£22.00

Prices quoted are for mail-in or on-site servicing, and for manual or electronic pipettes

Parts at additional cost

\*Specifically tailored to teaching labs and for large quantities of single-channels. On-site servicing at this level requires a minimum of 75 pipettes. On-site servicing for all standard service levels (except QuickCal) requires a minimum of 25 pipettes.



Customised servicing to your exact requirements also available – just let us know your specifications and we'll give you a competitive quote!

### Servicing & Repair of Pipette Controllers

- Pipette controller dismantled and cleaned inside.
- Reassembled and leak tested.
- Worn parts replaced if necessary
- External clean.
- Certificate of confirmation that the pipette controller has been serviced and tested and is delivering accurately.

Price: £18.00 per controller

# UKAS Servicing & Calibration

Our state of the art calibration laboratory is UKAS accredited. All our balances and weights are calibrated annually as part of the UKAS accreditation. As a UKAS accredited laboratory you can be sure that all STARLAB staff are competent and fully-trained, that our instruments are calibrated and properly maintained, and our servicing is carried out in the correct conditions. UKAS is an internationally recognised standard which ensures full traceability of data and requires both internal and external quality control.



4296

		5 Readings*		10 Readings	
		As Found	Pre & Post	As Found	Pre & Post
<b>SERVICE</b>	Pipette dismantled, inspected, leak tested, worn parts replaced	✗	✓	✗	✓
	Internal Clean	✗	✓	✗	✓
	External Clean	✗	✓	✗	✓
<b>CALIBRATE</b>	Single-Channel	5 readings at min, mid and max points	5 readings at min, mid and max points (pre and post)	10 readings at min, mid and max points	10 readings at min, mid and max points (pre and post)
	8-Channel	5 readings on each of the 8 channels, at min, mid and max points	5 readings on each of the 8 channels, at min, mid and max points (pre and post)	10 readings on each of the 8 channels, at min, mid and max points	10 readings on each of the 8 channels, at min, mid and max points (pre and post)
	12-Channel	5 readings on each of the 12 channels, at min, mid and max points	5 readings on each of the 12 channels, at min, mid and max points (pre and post)	10 readings on each of the 12 channels, at min, mid and max points	10 readings on each of the 12 channels, at min, mid and max points (pre and post)
	Calibration Certificate for each pipette	✓	✓	✓	✓
<b>TIME</b>	5-Day Turnaround	✓	✓	✓	✓
<b>SERVICE &amp; CALIBRATION</b>	Single-Channel	£25.00	£35.00	£45.00	£60.00
	8-Channel	£40.00	£50.00	£70.00	£80.00
	12-Channel	£45.00	£60.00	£80.00	£100.00

Prices quoted are for mail-in or on-site servicing, and for manual or electronic pipettes

**Parts at additional cost**

On-site servicing for all UKAS service levels requires a minimum of 15–20 pipettes.

**\*IMPORTANT:** By selecting 5 measurements per volume it is with the understanding that it will NOT permit a conclusion on conformity with ISO 8655.



# Spares for ErgoOne® Pipettes



Spares for Single-Channel Pipettes				
ErgoOne® Volume	SEALING RINGS (3/Pack)		SPACER RINGS (each)	
	Cat. No.	Price	Cat. No.	Price
2.5µl	inc with Tip Holder (see table below)		n/a	
10µl	inc with Tip Holder (see table below)		n/a	
20µl (Micro)	inc with Tip Holder (see table below)		n/a	
20µl (Standard)	inc with Tip Holder (see table below)		n/a	
100µl	P2311-1001	£2.40	P2391-1001	£4.50
200µl	P2311-2001	£1.90	P2391-1001	£4.50
1000µl	P2311-1101	£2.20	P2391-1101	£4.50
5000µl	n/a		n/a	

Spares for Single-Channel Pipettes						
ErgoOne® Volume	TIP HOLDERS (each)		TIP EJECTORS (each)		FILTER (10/Pack)	
	Cat. No.	Price	Cat. No.	Price	Cat. No.	Price
2.5µl	P2331-0021	£16.40	P2351-0021	£10.30	n/a	
10µl	P2331-0101	£14.50	P2351-0101	£9.00	n/a	
20µl (Micro)	P2331-0211	£14.20	P2351-0211	£9.00	n/a	
20µl (Standard)	P2331-0201	£5.60	P2351-0211	£9.00	n/a	
100µl	P2331-1001	£7.00	P2351-1001	£9.00	n/a	
200µl	P2331-2001	£7.50	P2351-2001	£9.50	n/a	
1000µl	P2331-1101	£7.70	P2351-1101	£10.00	n/a	
5000µl	P2331-1501	£11.50	P2351-1501	£9.30	P2391-1501	£4.00

Spares for Multi-Channel Pipettes		
ErgoOne® Volume	O-RINGS (4/Pack)	
	Cat. No.	Price
<b>8-Channel</b>		
10µl	n/a	
100µl	P2421-1001	£2.20
300µl	P2421-1001	£2.20
<b>12-Channel</b>		
10µl	n/a	
100µl	P2421-1001	£2.20
300µl	P2421-1001	£2.20

**STARLAB's ErgoOne® Pipettes**  
See pages 40–43

**ErgoOne®**

# Spares for Gilson® Pipettes



## Friction Ring

Cat. No.	Description	Pack Size	Price
P1162-0001	Friction Ring (Rubber)	1	£1.20

## Pistons

Cat. No.	Description	Pack Size	Price
P1142-0021	Piston for use with P2	1	£39.00
P1142-0101	Piston for use with P10	1	£39.00
P1142-0201	Piston for use with P20	1	£39.00
P1142-1001	Piston for use with P100	1	£39.00
P1142-2001	Piston for use with P200	1	£39.00
P1142-1101	Piston for use with P1000	1	£39.00

## Seals

Cat. No.	Description	Pack Size	Price
P1112-0021	Seal for use with P2	1	£4.60
P1112-0101	Seal for use with P10	1	£4.60
P1112-0201	Seal for use with P20	1	£3.60
P1112-1001	Seal for use with P100	1	£3.60
P1112-2001	Seal for use with P200	1	£3.60
P1112-1101	Seal for use with P1000	1	£3.60
P1112-1501	Seal for use with P5000	1	£4.60

## O-Rings

Cat. No.	Description	Pack Size	Price
P1122-0021	O-Ring for use with P2 & P10	1	£1.30
P1122-0201	O-Ring for use with P20	1	£1.30
P1122-1001	O-Ring for use with P100	1	£1.30
P1122-2001	O-Ring for use with P200	1	£1.30
P1122-1101	O-Ring for use with P1000	1	£1.30
P1122-1501	O-Ring for use with P5000	1	£1.30

## Tip Holders

Cat. No.	Description	Pack Size	Price
P1132-0021	Tip Holder for use with P2	1	£14.00
P1132-0101	Tip Holder for use with P10	1	£14.00
P1132-0201	Tip Holder for use with P20	1	£7.60
P1132-1001	Tip Holder for use with P100	1	£7.60
P1132-2001	Tip Holder for use with P200	1	£7.60
P1132-1101	Tip Holder for use with P1000	1	£9.30

## Tip Ejectors

Cat. No.	Description	Pack Size	Price
P1151-0021	Tip Ejector for use with P2 & P10	1	£8.80
P1151-0201	Tip Ejector for use with P20	1	£8.80
P1151-1001	Tip Ejector for use with P100	1	£8.80
P1151-2001	Tip Ejector for use with P200	1	£8.80
P1151-1101	Tip Ejector for use with P1000	1	£8.80

## Filter

Cat. No.	Description	Pack Size	Price
P1191-5000	Filter for use with P5ml & P10ml	10	£2.94



# Consumables

## TUBES

Microcentrifuge Tubes .....	58–59
Microcentrifuge Tube Accessories .....	60
Preparation Tubes .....	60
Centrifuge Tubes .....	61
Microtubes in Racks .....	61–62
Cryogenic Vials .....	63
Screw Cap Microtubes .....	64–65
Tubes & Containers .....	66–67

## PCR CONSUMABLES

PCR Tubes .....	68
PCR Strips .....	69–71
PCR Plates .....	72–75
PCR Plate–Cycler Compatibility .....	76–77
PCR Plate–Sealing Overview .....	78

## PLATES

PlateOne® Deepwell Plates .....	79
Deepwell Plates .....	80–82
Lid for SBS Plates .....	82
PlateOne® Microplates .....	83
Polystyrene Microplates .....	84
Polypropylene Assay Plates .....	84

## PLATE SEALING

Sealing Films & Foils .....	85
Sealing Accessories .....	86

## PARAFILM® & DISPENSER .....

## AUTOCCLAVE TAPE & AUTOCCLAVE BAGS .....

## CUVETTES .....

## REAGENT RESERVOIRS .....

## SCRAPERS, LOOPS & SPREADERS .....

## PASTEUR PIPETTES .....

## SPATULAS & WEIGH BOATS .....

## LABELLING

Cryogenic & Laboratory Labels .....	92–93
Laboratory ID Tape .....	94
BMP21™ Label Printer & Labels .....	95
LabPal™ & LabXpert™ Label Cartridges .....	96

# Microcentrifuge Tubes

## TubeOne



Available in convenient, mini-packs!

### TubeOne® microcentrifuge tubes

- Stays sealed during boiling, freezing or centrifuging, and easy to open afterwards!
- Frosted writing surface
- Optically clear without compromising structural integrity
- Conservatively rated to 20,000 x g, but will perform to higher specification under optimal conditions
- Supplied in resealable bags
- Autoclavable
- Temperature range: -80°C to 121°C
- Certified RNase, DNase, DNA and Pyrogen free

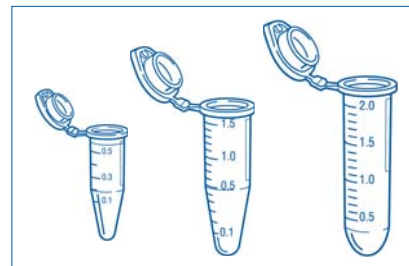

TubeOne® Microcentrifuge Tubes				
Cat. No.	Description / Tube Colour	Colour	Pack Size	Price
S1605-0000	0.5ml TubeOne® Microcentrifuge Tube	Natural	5 x 200	£22.26
S1605-0099	0.5ml TubeOne® Microcentrifuge Tube	Mixed*	5 x 200	£23.42
S1615-5500	1.5ml TubeOne® Microcentrifuge Tube	Natural	500	£11.13
S1615-5550	1.5ml TubeOne® Microcentrifuge Tube	Natural	5 x 100	£12.29
S1615-5510	1.5ml TubeOne® Microcentrifuge Tube (Sterile)	Natural	5 x 100	£17.85
S1615-5599	1.5ml TubeOne® Microcentrifuge Tube	Mixed*	5 x 100	£12.29
S1620-2700	2.0ml TubeOne® Microcentrifuge Tube	Natural	500	£20.06
S1620-2799	2.0ml TubeOne® Microcentrifuge Tube	Mixed*	5 x 100	£21.74

\*Mixed packs contain following colour tubes: blue, green, red, violet and yellow.

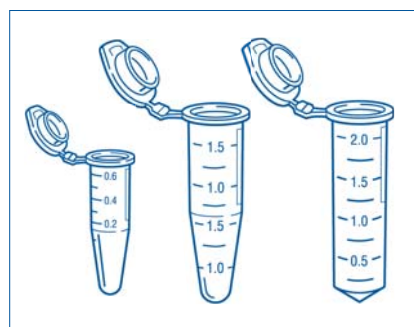

Certified RNase, DNase and Pyrogen free

### The difference is clear!

- 'Crystal Clear' polypropylene tubes for the ultimate in sample visibility
- Ultra smooth tube bottoms for 100% visibility
- Frosted writing surface
- Thin cap membrane for easy sample access with a syringe needle
- Rated at 14,000–20,000 x g
- Autoclavable
- Temperature range: -80°C to 121°C

'Crystal Clear' Microcentrifuge Tubes				
Cat. No.	Description	Colour	Pack Size	Price
E1405-0600	0.6ml Crystal Clear Microcentrifuge Tube	Natural	2 x 500	£22.26
E1405-0610	0.6ml Crystal Clear Microcentrifuge Tube (Sterile)	Natural	5 x 100	£14.49
E1415-1500	1.5ml Crystal Clear Microcentrifuge Tube	Natural	500	£11.12
E1415-1510	1.5ml Crystal Clear Microcentrifuge Tube (Sterile)	Natural	5 x 50	£8.93
E1420-2000	2.0ml Crystal Clear Microcentrifuge Tube	Natural	500	£12.29
E1420-2010	2.0ml Crystal Clear Microcentrifuge Tube (Sterile)	Natural	5 x 50	£9.98

NOTE: Due to the sterilisation process, sterile tubes are not as clear as the non-sterile tubes.

# Microcentrifuge Tubes

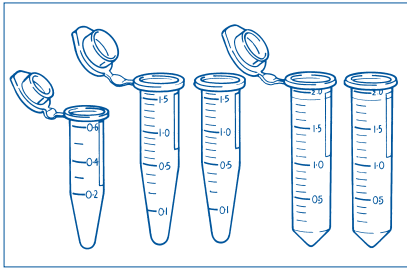

Certified RNase, DNase, DNA and PCR Inhibitor free

## Graduated microcentrifuge tubes in natural, amber or capless

- Amber tubes for light sensitive samples
- Capless tubes for convenient collection of fractions or mix reagents
- Autoclavable
- Smaller lid footprint for better fit inside sample storage boxes
- Rated to over 20,000 x g
- Temperature range: -80°C to 121°C

### Graduated Microcentrifuge Tubes

Cat. No.	Description	Colour	Pack Size	Price
I1405-1500	0.5ml Homopolymer Microcentrifuge Tube	Natural	1000	£21.00
I1405-1507	0.5ml Homopolymer Microcentrifuge Tube	Amber	1000	£21.00
I1415-1000	1.5ml Homopolymer Microcentrifuge Tube	Natural	500	£11.55
I1415-1007	1.5ml Homopolymer Microcentrifuge Tube	Amber	500	£11.55
E1415-2850	1.5ml Homopolymer Microcentrifuge Tube, no Cap	Natural	500	£9.98
I1420-2700	2.0ml Homopolymer Microcentrifuge Tube	Natural	500	£15.65
I1420-2707	2.0ml Homopolymer Microcentrifuge Tube	Amber	500	£15.65
E1420-2850	2.0ml Homopolymer Microcentrifuge Tube, no Cap	Natural	500	£12.60

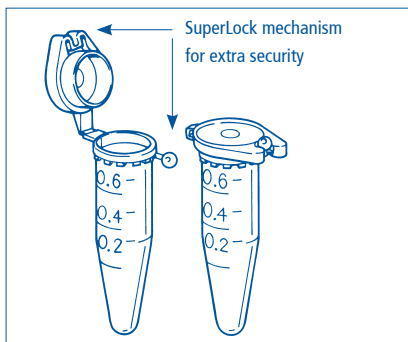

Certified RNase and DNase free

## Super safe, SuperLock tubes

- Locking tubes for the highest security
- Frosted writing area
- Pierceable cap
- Rated at 17,000 x g
- Temperature range: -80°C to 121°C
- Autoclavable

### Locking Microcentrifuge Tubes

Cat. No.	Description	Colour	Pack Size	Price
E1405-5100	0.5ml Superlock Microcentrifuge Tube	Natural	1000	£22.89
I1415-5100	1.5ml Superlock Microcentrifuge Tube	Natural	500	£13.34
E1420-5100	2.0ml Superlock Microcentrifuge Tube	Natural	500	£16.70
E1420-5108	2.0ml Superlock Microcentrifuge Tube	Mixed	5 x 100	£16.70

## Ultra high recovery tubes

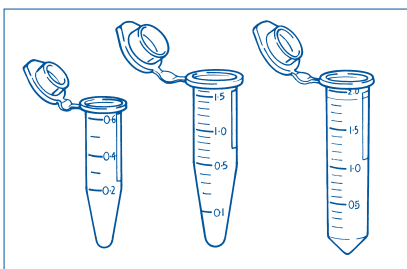



Certified RNase, DNase, DNA and PCR Inhibitor free

Convenient for RNA or DNA pelleting or protein handling which often requires a low-adhesion surface, these ultra high recovery tubes are completely non-reactive. Rated to over 20,000 x g. Temperature range: -80°C to 121°C. Autoclavable.

### Ultra High Recovery Microcentrifuge Tubes

Cat. No.	Description	Colour	Pack Size	Price
E1405-2600	0.5ml Ultra High Recovery Microcentrifuge Tube	Natural	500	£12.29
E1415-2600	1.5ml Ultra High Recovery Microcentrifuge Tube	Natural	250	£9.88
I1420-2600	2.0ml Ultra High Recovery Microcentrifuge Tube	Natural	250	£12.60

## Microcentrifuge Tube Accessories

Microcentrifuge Tube Accessories					
		For Use with	Cat. No.	Pack Size	Price
	<b>Cap Locks:</b> Reusable cap locks to securely seal tubes for rigorous boiling/freezing. Assorted colours to aid sample identification. Compatible with most microcentrifuge tubes.	0.5ml Tubes	E1405-9000	100	£14.18
		1.5/2.0ml Tubes	I1415-1508	100	£14.18
	<b>Tube Openers:</b> For use with all 0.5ml to 2.0ml microcentrifuge tubes. Also aids in the safe opening of glass ampules.	0.5ml to 2.0ml Tubes	I1400-1008	100	£24.68
	<b>Microtube Pestles:</b> Disposable polypropylene pestles. Ideal for homogenising cells or resuspending DNA or protein pellets. Certified RNase, DNase and DNA free.	0.5ml Tubes	I1405-4390	10	£6.62
		1.5/2.0ml Tubes	I1415-5390	10	£6.62

All Cap Locks, Microtube Openers and Microtube Pestles are supplied in mixed packs of blue, green, orange, red, pink and yellow.

## Preparation Tubes

**New!**



- Ideal for biological or chemical solution preparation
- Suitable for microbial incubation and pellet preparation
- Black tube for light sensitive reactions
- Made from virgin polypropylene, the tubes are graduated at 1ml intervals and have a frosted writing area on the cap and side of tube
- Temperature use: -80°C to 121°C. Autoclavable
- Centrifugation rate: 5000 x g

### 5.0ml Preparation Tubes

Cat. No.	Description	Colour	Pack Size	Price
<b>Conical Tubes</b>				
E1450-0000	5.0ml Preparation Tube, Conical	Natural	250	£42.20
E1450-0001	5.0ml Preparation Tube, Conical	Blue	250	£42.20
E1450-0002	5.0ml Preparation Tube, Conical	Green	250	£42.20
E1450-0004	5.0ml Preparation Tube, Conical	Red	250	£42.20
E1450-0006	5.0ml Preparation Tube, Conical	Yellow	250	£42.20
E1450-0008	5.0ml Preparation Tube, Conical	Black	250	£42.20
<b>Skirted Tube</b>				
E1450-1000	5.0ml Preparation Tube, Skirted	Natural	250	£42.40

Dimensions (HxØ): 18 x 60mm.

**FREE SAMPLE**  
**TRY**  
before you  
**BUY**  
available on request

# Centrifuge Tubes

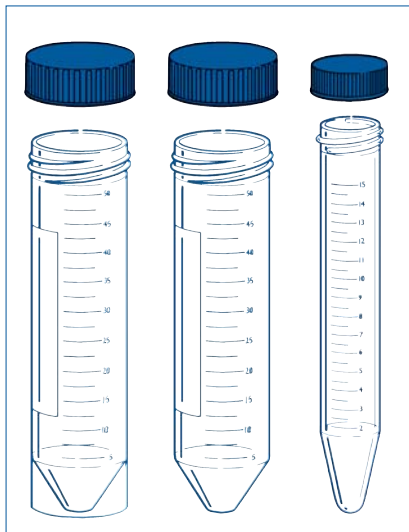

## Don't get in a spin! Use STARLAB centrifuge tubes!

- Clear, polypropylene tubes with blue HDPE screw caps
- Clearly marked graduations
- White writing surface
- Sterile
- Centrifugation rates (swing bucket / fixed angle rotors):
  - 4000 / 15,000 x g (15ml)
  - 3200 / 9500 x g (50ml)
  - 2800 / 11,500 x g (50ml skirted)
- Certified RNase, DNase, DNA and pyrogen free



Centrifuge Tubes			
Cat. No.	Description	Pack Size	Price
<b>15ml Centrifuge Tubes</b>			
E1415-0200	15ml Centrifuge Tube, Conical, Loose (Sterile)	10 x 50-Tube Bags	£89.04
E1415-0800	15ml Centrifuge Tube, Conical, Racked (Sterile)	10 x 50-Tube Racks	£94.61
<b>50ml Centrifuge Tubes</b>			
E1450-0200	50ml Centrifuge Tube, Conical, Loose (Sterile)	10 x 50-Tube Bags	£89.04
E1450-0800	50ml Centrifuge Tube, Conical, Racked (Sterile)	20 x 25-Tube Racks	£94.61
E1450-0500	50ml Centrifuge Tube, Skirted, Loose (Sterile)	10 x 50-Tube Bags	£89.04

Dimensions inc. cap (HxØ): 15ml: 120.5 x 22mm. 50ml: 115.5 x 34.9mm. 50ml skirted: 116.5 x 34.9mm.

# Microtubes in Rack

Certified RNase, DNase, DNA and Pyrogen free



## Organised storage

- SBS footprint and compatible with all robotic applications and multi-channel pipetting
- Ideal for serial dilutions, mixing, storage and harvesting of cells, cell growth assays, DNA screening and long-term storage
- Clear printed matrix on rack
- Transparent lid
- Temperature use -80°C to 121°C

Micro-Dilution Tube System			
Cat. No.	Description	Pack Size	Price
<b>Racks / Individual Tubes</b>			
E1750-0400	1.2ml Reaction Tubes in Rack (96 Individual Tubes)	10	£27.83
E1750-0410	1.2ml Reaction Tubes in Rack (96 Individual Tubes) (Sterile)	10	£31.19
E1710-0000	1.2ml Individual Reaction Tubes	1000	£17.01
<b>Racks / 8-Strip Tubes</b>			
E1760-8400	1.2ml Reaction Tubes in Rack (12 x 8-Strip Tubes)	10	£27.83
E1760-8410	1.2ml Reaction Tubes in Rack (12 x 8-Strip Tubes) (Sterile)	10	£31.19
E1720-8000	1.2ml 8-Strip Reaction Tubes	125	£17.01
<b>Racks / 12-Strip Tubes</b>			
E1770-9400	1.2ml Reaction Tubes in Rack (8 x 12-Strip Tubes)	10	£27.83
E1770-9410	1.2ml Reaction Tubes in Rack (8 x 12-Strip Tubes) (Sterile)	10	£31.19
E1730-9000	1.2ml 12-Strip Reaction Tubes	80	£17.01
<b>Strip Caps</b>			
E1702-8400	8-Strip Caps for 1.2ml Reaction Tubes	125	£11.66
E1702-8410	8-Strip Caps for 1.2ml Reaction Tubes (Sterile)	125	£13.97
E1703-9400	12-Strip Caps for 1.2ml Reaction Tubes	80	£11.66
E1703-9410	12-Strip Caps for 1.2ml Reaction Tubes (Sterile)	80	£13.97

NOTE: PP tubes and racks are autoclavable. PE strip caps can not be autoclaved. Rack dimensions (WxDxH): 128 x 85.5 x 47.25mm (with lid).

# Microtubes in Rack

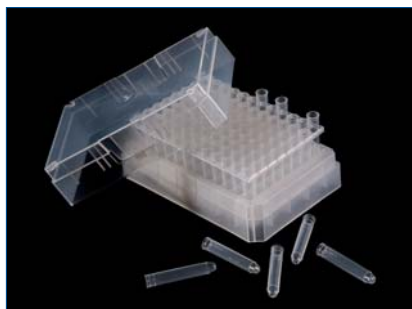

## Alpha-numeric coded tubes in rack

- Refillable! Tube refills are supplied in a frame ready to load into racks
- The tube frame prevents tubes falling out of rack or the codes getting out of sequence
- SBS footprint compatible with all robotics applications
- Alpha-numeric codes printed on bottom of each tube
- Ideal for archiving samples
- Suitable for stackable systems
- Lockable, clear lid
- Temperature use -80°C to 121°C

Alpha-Numeric Coded Tubes in Rack			
Cat. No.	Description	Pack Size	Price
<b>0.65ml Tubes</b>			
E1780-3100	Tube Rack with Lid, Pre-Filled with 96 x 0.65ml Alpha-Numeric Coded Tubes	10 Racks	£77.91
E1780-3700	Tube Rack Refill Frame, Loaded with 96 x 0.65ml Alpha-Numeric Coded Tubes	10 Refills	£46.73
<b>1.2ml Tubes</b>			
E1780-2100	Tube Rack with Lid, Pre-Filled with 96 x 1.2ml Alpha-Numeric Coded Tubes	10 Racks	£77.91
E1780-2700	Tube Rack Refill Frame, Loaded with 96 x 1.2ml Alpha-Numeric Coded Tubes	10 Refills	£46.73
<b>Sealing Options</b>			
E1780-8400	8-Strip Caps for 0.65ml or 1.2ml Tubes	1000/Bag	£155.82
E1780-8500	Piercable Cap Mat for 0.65ml or 1.2ml Tubes	10 Mats	£19.53

NOTE: PP tubes and racks are autoclavable. Strip caps and cap mat are not autoclavable.  
 0.65ml Rack dimensions: 127 x 85 x 50 (with lid).  
 1.2ml Rack dimensions: 127 x 85 x 50 (with lid).

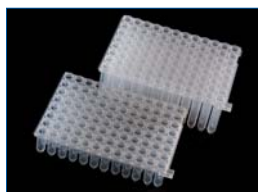
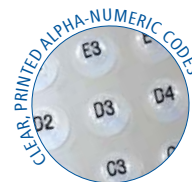

Refill frames loaded with tubes



Piercable cap mat



8-strip caps

## Microtubes in rack with removable base

A heavy duty rack with the same footprint as a standard plate, containing 96 individual 1.2ml tubes. Each tube is fully supported at the base to withstand the pressures applied by robotic systems. The base of the rack can be easily removed for waterbath applications. Moulded reference grid on lid. Suitable for use down to -80°C.



Non-sterile product certified RNase and DNase free  
 Sterile product certified RNase, DNase, DNA and Pyrogen free

1.2ml Microtubes in Rack			
Cat. No.	Description	Pack Size	Price
I1412-7400	1.2ml Microtubes in Rack	10	£30.66
I1412-7410	1.2ml Microtubes in Rack (Sterile)	10	£34.55
I1494-1400	8-Strip Caps for 1.2ml Microtubes	120	£13.34
I1494-1410	8-Strip Caps for 1.2ml Microtubes (Sterile)	120	£15.54

NOTE: PP tubes and racks are autoclavable. PE strip caps can not be autoclaved.  
 Rack dimensions (WxDxH): 85 x 127 x 41mm (with lid).



# Cryogenic Vials

**New!**

STARLAB Cryogenic Vials have been developed for the storage and transportation of biological material.

- Made from 100% polypropylene
- For storage down to -196°C; **should only be used in the gas phase of liquid nitrogen**
- Internal threaded vials with a silicone seal in cap for the highest possible impermeability
- Skirted vials lock into racks\* for easy single-handed work
- White writing area and highly-visible black graduations at 100µl increments

Cryogenic Vials (Sterile)							
Tube Volume	<b>1.0ml</b>	<b>1.8ml</b>	<b>1.8ml</b>	<b>3.6ml</b>	<b>3.6ml</b>	<b>4.5ml</b>	<b>4.5ml</b>
Tube Style	Skirted	Conical	Skirted	Conical	Skirted	Conical	Skirted
	E3090-6212 £94.50 Pack Size: 10 x 50 Height: 41mm	E3090-6321 £94.50 Pack Size: 10 x 50 Height: 43mm	E3090-6222 £94.50 Pack Size: 10 x 50 Height: 48mm	n/a	n/a	n/a	E3090-6242 £68.25 Pack Size: 6 x 50 Height: 91mm
	<b>External Threaded Tube Self-Sealing Cap</b>						
	E3110-6112 £110.25 Pack Size: 10 x 50 Height: 42mm	E3110-6121 £115.50 Pack Size: 10 x 50 Height: 46mm	E3110-6122 £110.25 Pack Size: 10 x 50 Height: 49mm	E3110-6131 £94.50 Pack Size: 8 x 50 Height: 70mm	E3110-6132 £94.50 Pack Size: 8 x 50 Height: 71mm	E3110-6141 £94.50 Pack Size: 6 x 50 Height: 90mm	E3110-6142 £94.50 Pack Size: 6 x 50 Height: 91mm
	<b>Internal Threaded Tube Silicone Seal in Cap</b>						

Supplied in convenient, resealable, self-standing pouches



The caps of the cryogenic vials can be colour coded with coloured cap inserts.

Coloured Cap Inserts												
		E1494-6###* £12.71 Pack Size: 500	*To order the colour required, replace ### as last three digits of Cat. No. with:									
001 Blue	002 Green	003 Orange	004 Red	104 Pink	005 Violet	006 Yellow	007 Brown	108 Grey	009 White	099 Mixed		

Cryogenic Accessories			
Cat. No.	Description	Pack Size	Price
<b>Storage Canes</b>			
E2005-5000	Storage Canes for 5 x 1.2/2.0ml Cryogenic Vials	12	£9.98
<b>Cryogenic Labels for use down to -196°C</b>			
E9189-0099	9.5mm Cryogenic Spot Labels, Mixed	5000/Roll	£32.50
E9189-3009	StarTag Cryo (38 x 15mm), White	1000 Labels/Roll	£21.11

See page 92 for more info on cryogenic labels.

See pages 103–104 for cryogenic storage boxes and work racks



\*Lock rack page 104

# Screw Cap Microtubes



## Mix and match – tubes and caps!

- Suitable for many applications from sample storage in the **gas phase of liquid nitrogen** to freezer, through boiling to autoclave
- Routinely tested to 20,000 x g
- All tubes and caps are autoclavable

		Tubes only									
		<b>0.5ml</b>	<b>0.5ml</b>	<b>0.5ml</b>	<b>1.5ml</b>	<b>1.5ml</b>	<b>1.5ml</b>	<b>1.5ml</b>	<b>2.0ml</b>	<b>2.0ml</b>	<b>2.0ml</b>
		Ribbed	Plain	Plain	Ribbed	Ribbed	Graduated	Plain	Ribbed	Graduated	Graduated
		Skirted	Skirted	Conical	Skirted	Conical	Conical	Skirted	Skirted	Conical	Skirted
	<b>Natural Tubes</b> 100% polypropylene.	E1405-2120 £15.86 Pack 500	E1405-2140 £15.86 Pack 500	E1405-2130 £15.86 Pack 500	E1415-2220 £15.86 Pack 500	E1415-2210 £15.86 Pack 500	E1415-2230 £15.86 Pack 500	E1415-2240 £15.86 Pack 500	E1420-2320 £15.86 Pack 500	E1420-2330 £15.86 Pack 500	E1420-2340 £15.86 Pack 500
	<b>Amber Tubes</b> 100% polypropylene. Suitable for light sensitive samples.	E1405-2127 £15.86 Pack 500	n/a	n/a	E1415-2227 £15.86 Pack 500	n/a	E1415-2237 £15.86 Pack 500	n/a	n/a	E1420-2337 £15.86 Pack 500	E1420-2347 £15.86 Pack 500

		EasyGrip Caps only								
		Natural/White	White/Blue	White/Green	White/Orange	White/Red	White/Violet	White/Yellow	White/White	Mixed
	<b>Easy Grip Caps</b> Opaque white* polypropylene cap with a coloured secure seal/grip made from inert TPE. The one-piece construction ensures a leak-free seal that will never fall out!	E1480-0300 £31.19 Pack 500	E1480-0301 £31.19 Pack 500	E1480-0302 £31.19 Pack 500	E1480-0303 £31.19 Pack 500	E1480-0304 £31.19 Pack 500	E1480-0305 £31.19 Pack 500	E1480-0306 £31.19 Pack 500	E1480-0309 £31.19 Pack 500	E1480-0399 £31.19 Pack 500

\*except E1480-0300

		Standard & Tethered Caps only									
		Natural	Blue	Green	Orange	Red	Violet	Yellow	Amber	Black	Mixed
	<b>Standard Caps</b> Polypropylene cap with separate, ethylene-propylene o-ring inside to form a seal against the rim of the tube.	E1480-0100 £33.18 Pack 500	E1480-0101 £33.18 Pack 500	E1480-0102 £33.18 Pack 500	E1480-0103 £33.18 Pack 500	E1480-0104 £33.18 Pack 500	E1480-0105 £33.18 Pack 500	E1480-0106 £33.18 Pack 500	E1480-0107 £33.18 Pack 500	E1480-0108 £33.18 Pack 500	E1480-0199 £33.18 Pack 500
		<b>Tethered Caps</b> Polypropylene cap with separate, ethylene-propylene o-ring inside to form a seal against the rim of the tube.	E1480-0200 £34.97 Pack 500	E1480-0201 £34.97 Pack 500	E1480-0202 £34.97 Pack 500	E1480-0203 £34.97 Pack 500	E1480-0204 £34.97 Pack 500	E1480-0205 £34.97 Pack 500	E1480-0206 £34.97 Pack 500	E1480-0207 £34.97 Pack 500	E1480-0208 £34.97 Pack 500

# Screw Cap Microtubes (Sterile)



Sterile product is supplied in convenient, resealable mini pouches

	Ready-Assembled Tubes & Caps (Sterile)				
Volume:	0.5ml	1.5ml	1.5ml	2.0ml	2.0ml
Style:	Plain	Graduated	Plain	Graduated	Graduated
Base:	Skirted	Conical	Skirted	Conical	Skirted

## Assembled sterile tubes & caps

- Sterile, ready-assembled tube and cap packs
- Supplied in convenient, resealable mini pouches which stand up on your bench
- Suitable for many applications from sample storage in the **gas phase of liquid nitrogen** through freezer to boiling
- Routinely tested to 20,000 x g

	<b>with Natural Standard Caps (Sterile)</b> Tubes supplied ready assembled with natural standard caps with o-ring seal.	E1405-2141 £33.39 Pack 5 x 50	E1415-2231 £33.39 Pack 5 x 50	E1415-2241 £33.39 Pack 5 x 50	E1420-2331 £33.39 Pack 5 x 50	E1420-2341 £33.39 Pack 5 x 50
	<b>with Natural Tethered Caps (Sterile)</b> Tubes supplied ready assembled with natural tethered caps with o-ring seal.	E1405-2142 £41.16 Pack 5 x 50	E1415-2232 £41.16 Pack 5 x 50	E1415-2242 £41.16 Pack 5 x 50	E1420-2332 £41.16 Pack 5 x 50	E1420-2342 £41.16 Pack 5 x 50
	<b>with Natural/White EasyGrip Caps (Sterile)</b> Tubes supplied ready assembled with natural EasyGrip Caps with white, integral grip/seal.	E1405-2143 £32.55 Pack 5 x 50	E1415-2233 £32.55 Pack 5 x 50	E1415-2243 £32.55 Pack 5 x 50	E1420-2333 £32.55 Pack 5 x 50	E1420-2343 £32.55 Pack 5 x 50
	<b>with White/Colour EasyGrip Caps (Sterile)*</b> Tubes supplied ready assembled with opaque white EasyGrip Caps with coloured, integral grip/seal.	E1405-030# £32.55 Pack 5 x 50	E1415-030# £32.55 Pack 5 x 50	E1415-031# £32.55 Pack 5 x 50	E1420-030# £32.55 Pack 5 x 50	E1420-031# £32.55 Pack 5 x 50



**New!**

Ready-assembled sterile tubes with EasyGrip Caps

E1420-0314

\* To order colour of grip/seal required, replace # as last digit of Cat. No. with:



# High Impact Screw Cap Microtubes



**New!**

## High impact tube specially formulated for bead-beating applications

- Semi-opaque polypropylene tube with natural, polypropylene screw cap with ethylene-polypropylene o-ring inside
- Shatter resistant
- Supplied ready assembled
- Autoclavable
- Routinely tested to 15,000 x g
- Certified RNase, DNase, DNA and PCR Inhibitor free

High Impact Screw Cap Microtube			
Cat. No.	Description	Pack Size	Price
E1420-2641	2.0ml Graduated, High Impact Screw Cap Microtube	200	£59.00

# Tubes & Containers



Polypropylene or polystyrene tubes graduated at 1ml, 2.5ml and 4ml. Leakproof push-on polyethylene cap with a ribbed plug to clamp firmly on the tube. Centrifugation rates: 15,000 x g (PP), 7000 x g (PS). Temperature use: -50°C to 80°C\* (PP), -10°C to 70°C (PS).

### 12x75 Tubes

Cat. No.	Description	Pack Size	Price
E1412-6201	12x75 Polypropylene Graduated Tube	2 x 1000	£31.19
E1412-6200	12x75 Polystyrene Graduated Tube	2 x 1000	£31.19
E1412-6300	Cap for 12x75 Graduated Tubes, PE, Natural	2000	£29.09

Dimensions: Tube (HxØ): 75 x 12mm. Cap: 15 x 15mm. \*PP tubes (without cap) are autoclavable (temperature range -80°C to 121°C).

**New!**



HDPE vials with leak-proof screw cap. Compatible with all liquid scintillation counters. Also suitable for use on the 930-FRAC collection unit of the AKTA® Protein Purification System. Heavy wall minimises solvent loss. Temperature use range: -50°C to 80°C.

### Scintillation Vial Insert

Cat. No.	Description	Pack Size	Price
E1412-7000	4ml Scintillation Vial Insert Tube with Screw Cap	1000	£65.00

Dimensions (HxØ): 53.6 x 13.7mm (inc. cap).



Ultra clear, sterile polystyrene bijou container with white polypropylene cap. Centrifugation rate 7200 x g. Temperature use: -10°C to 70°C.

### 7.0ml Bijou Containers

Cat. No.	Description	Pack Size	Price
E1412-0710	7.0ml Polystyrene Bijou Container, without Label (Sterile)	700	£90.20
E1412-0711	7.0ml Polystyrene Bijou Container, with Label (Sterile)	700	£93.56

Dimensions (HxØ): 50 x 23mm (inc. cap).

**FREE SAMPLE**  
**TRY**  
before you  
**BUY**  
available on request



Aseptically produced crystal clear polystyrene tube with green HDPE screw cap. Centrifugation rate: 7,000 x g. Temperature use: -10°C to 70°C.

### 12ml Skirted Tube

Cat. No.	Description	Pack Size	Price
E1412-1200	12ml Polystyrene Screw Cap Tube, Skirted (Sterile <sup>1</sup> )	250	£38.96

Dimensions (HxØ): 105 x 21mm (inc. cap). <sup>1</sup>Aseptically produced in a fully-automated and bio-controlled environment.



Polypropylene (PP) or polystyrene (PS) sterile tubes with white writing area and graduations at 0.25ml increments. Dual position caps, which can be left loose for aerobic work or sealed for anaerobic culture. Centrifugation rates: 3000 x g (PP), 1400 x g (PS). Temperature use: -190°C to 120°C (PP), -10°C to 70°C (PS).

### 12ml Culture Tubes (Sterile)

Cat. No.	Description	Pack Size	Price
I1485-0810	12ml Polypropylene Culture Tube with Cap (Sterile)	20 x 25-Tube Bags	£94.08
I1485-2810	12ml Polystyrene Culture Tube with Cap (Sterile)	20 x 25-Tube Bags	£94.08

Dimensions (HxØ): 100 x 23mm (inc. cap).

# Tubes & Containers

**New!**



20ml HDPE scintillation vial with leak-proof polypropylene screw cap. Temperature use: -50°C to 80°C.

Scintillation Vial			
Cat. No.	Description	Pack Size	Price
E1412-7100	20ml Plastic Scintillation Vial	1000	£135.00

Dimensions (HxØ): 58 x 26mm (inc. cap).



30ml polypropylene (PP) or polystyrene (PS) containers with white, polypropylene cap. Aseptically produced. Available with or without labels. Centrifugation rates: 3000 x g (PP), 1600 x g (PS). Temperature use: -80°C to 121°C (PP), -10°C to 70°C (PS). PP containers (without cap) are autoclavable.

30ml Universal Containers			
Cat. No.	Description	Pack Size	Price
E1412-3020	30ml Polypropylene Universal Container, No Label (Sterile <sup>1</sup> )	400	£35.60
E1412-3021	30ml Polypropylene Universal Container, Plain Label (Sterile <sup>1</sup> )	400	£37.91
E1412-3022	30ml Polypropylene Universal Container, Printed Label (Sterile <sup>1</sup> )	400	£37.91
E1412-3010	30ml Polystyrene Universal Container, No Label (Sterile <sup>1</sup> )	400	£47.88
E1412-3011	30ml Polystyrene Universal Container, Plain Label (Sterile <sup>1</sup> )	400	£50.09
E1412-3012	30ml Polystyrene Universal Container, Printed Label (Sterile <sup>1</sup> )	400	£51.24

Dimensions (HxØ): 93 x 31mm (inc. cap). <sup>1</sup>Aseptically produced in a fully-automated and bio-controlled environment.

**FREE SAMPLE**  
**TRY**  
before you  
**BUY**  
available on request



60ml crystal clear polystyrene container with red polyethylene screw cap. Aseptically produced. Temperature use: -10°C to 70°C.

60ml Polystyrene Screw Cap Container			
Cat. No.	Description	Pack Size	Price
E1412-6004	60ml Polystyrene Container, Red Screw Cap (Sterile <sup>1</sup> )	600	£75.00

Dimensions (HxØ): 66 x 44,5mm (inc. cap). <sup>1</sup>Aseptically produced in a fully-automated and bio-controlled environment.



125ml polypropylene container with red polyethylene screw cap. 20ml graduations up to 100ml. Frosted writing panel. Aseptically produced. Temperature use: -10°C to 70°C.

125ml Polypropylene Screw Cap Container			
Cat. No.	Description	Pack Size	Price
E1412-6104	125ml Polypropylene Graduated Container, Red Cap (Sterile <sup>1</sup> )	475	£61.22

Dimensions (HxØ): 75 x 62mm (inc. cap). <sup>1</sup>Aseptically produced in a fully-automated and bio-controlled environment.

**New!**

100ml Container  
250ml Container



Sterile, 60ml crystal clear polystyrene container with printed patient label or aseptically produced crystal clear 100ml, 150ml or 250ml polystyrene containers. All have aluminium screw caps. Temperature use: -10°C to 70°C.

Straight-Sided Metal Cap Containers			
Cat. No.	Description	Pack Size	Price
E1412-6000	60ml Polystyrene Container, Metal Cap, Printed Label (Sterile)	300	£65.63
E1412-1000	100ml Polystyrene Container, Metal Cap (Sterile <sup>1</sup> )	160	£57.80
E1412-1500	150ml Polystyrene Container, Metal Cap (Sterile <sup>1</sup> )	120	£63.42
E1412-2500	250ml Polystyrene Container, Metal Cap (Sterile <sup>1</sup> )	48	£39.75

Dimensions (HxØ): 60ml: 60 x 45mm (inc. cap). 100ml: 75 x 45mm (inc. Cap). 150ml: 108 x 55mm (inc. cap). 250ml: 121 x 65mm (inc. cap). <sup>1</sup>Aseptically produced in a fully-automated and bio-controlled environment.

# PCR Tubes

## Single PCR tubes

- PCR tubes manufactured from medical grade polypropylene
- Positive click on closing gives assurance that tubes are fully closed
- Ultra thin walls ensure efficient thermal transfer and maximum yield
- Supplied in resealable bags
- Certified RNase, DNase, DNA and PCR Inhibitor free



I1405-8100 and I1402-8100



The integral shield on the cap prevents accidental finger contamination with the surface of the lid

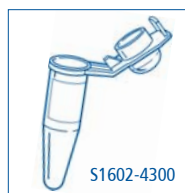

0.2ml PCR Tubes				
Cat. No.	Description	Colour	Pack Size	Price
<b>Domed Caps</b>				
I1402-4300	<b>C</b> 0.2ml PCR Tube, Domed Cap	Natural	1000	£35.60
I1402-4308	0.2ml PCR Tube, Domed Cap	Mixed*	5 x 200	£35.60
<b>Flat Caps</b>				
I1402-8100	<b>C</b> 0.2ml PCR Tube, Flat Cap	Natural	1000	£35.60
I1402-8108	0.2ml PCR Tube, Flat Cap	Mixed*	5 x 200	£35.60
I1402-8200	0.2ml PCR Tube, Flat Cap (X-Clear ) for qPCR	Natural	1000	£35.60

\*Mixed packs contain: blue, green, red, violet, yellow.

0.2ml PCR Tubes, Shielded Caps				
Cat. No.	Description	Colour	Pack Size	Price
S1602-4300	0.2ml PCR Tube, Domed Shielded Cap	Natural	1000	£40.11

0.5ml PCR Tubes				
Cat. No.	Description	Colour	Pack Size	Price
<b>Domed Caps</b>				
I1405-8200	<b>C</b> 0.5ml PCR Tube, Domed Cap	Natural	1000	£25.62
I1405-8208	0.5ml PCR Tube, Domed Cap	Mixed*	5 x 200	£27.83
<b>Flat Caps</b>				
I1405-8100	<b>C</b> 0.5ml PCR Tube, Flat Cap	Natural	1000	£25.62
I1405-8108	0.5ml PCR Tube, Flat Cap	Mixed*	5 x 200	£27.83

\*Mixed packs contain: blue, green, red, violet, yellow.



**C CASE SIZES (x10 packs) available at discount!** To order by the case, add **-C** to the end of the Cat. No.



# PCR Strips

## Strip tubes and strip caps

- PCR tube and cap strips made from medical grade polypropylene
- Strips can be easily split into smaller sections by snapping apart
- White strip tubes and extra clear flat cap strips suitable for qPCR
- Supplied in resealable bags
- Certified RNase, DNase, DNA and PCR Inhibitor free



I1402-1200 and I1400-1200



**New!**  
**New!**

8-Strip				
Cat. No.	Description	Colour	Pack Size	Price
<b>Tubes only</b>				
I1402-3600	0.1ml 8-Strip PCR Tubes, Low-Profile	Natural	125	£75.00
I1402-3609	0.1ml 8-Strip PCR Tubes, Low-Profile	White	125	£66.78
I1402-3500 <b>C</b>	0.2ml 8-Strip PCR Tubes	Natural	125	£66.78
I1402-3508	0.2ml 8-Strip PCR Tubes	Mixed*	5 x 25	£66.78
I1402-3509	0.2ml 8-Strip PCR Tubes	White	125	£66.78
<b>Caps only</b>				
I1400-0800 <b>C</b>	8-Strip PCR Caps, Domed	Natural	125	£12.29
I1400-0808	8-Strip PCR Caps, Domed	Mixed*	5 x 25	£12.29
I1400-0900 <b>C</b>	8-Strip PCR Caps, Flat (X-Clear) for qPCR	Natural	125	£12.29
<b>Tube &amp; Cap Combo Packs</b>				
I1402-4700	0.1ml 8-Strip PCR Tubes, Low-Profile and 8-Strip PCR Caps, Flat (X-Clear)	Natural/ Natural	125 pairs	£80.00
I1409-4700	0.1ml 8-Strip White PCR Tubes, Low-Profile and 8-Strip PCR Caps, Flat (X-Clear)	White/ Natural	125 pairs	£80.00
I1402-5700	0.2ml 8-Strip PCR Tubes and 8-Strip PCR Caps, Flat (X-Clear)	Natural/ Natural	125 pairs	£80.00
I1409-5700	0.2ml 8-Strip White PCR Tubes and 8-Strip PCR Caps, Flat (X-Clear)	White/ Natural	125 pairs	£80.00

\*Mixed packs contain: blue, green, red, violet, yellow.



**New!**  
**New!**  
**New!**  
**New!**



12-Strip				
Cat. No.	Description	Colour	Pack Size	Price
<b>Tubes only</b>				
I1402-1200 <b>C</b>	0.2ml 12-Strip PCR Tubes	Natural	80	£66.78
I1402-1208	0.2ml 12-Strip PCR Tubes	Mixed*	5 x 16	£66.78
<b>Caps only</b>				
I1400-1200	12-Strip PCR Caps, Domed	Natural	80	£16.70
I1400-1208	12-Strip PCR Caps, Domed	Mixed*	5 x 16	£16.70
I1400-1290	12-Strip PCR Caps, Flat (X-Clear)	Natural	80	£16.70

\*Mixed packs contain: blue, green, red, violet, yellow.

**C CASE SIZES (x10 packs) available at discount!** To order by the case, add **-C** to the end of the Cat. No.

# PCR Strips

## Tube strips with attached caps

- Tube and cap PCR strips made from medical grade polypropylene
- Attached caps eliminates the possibility of cross-contamination through accidental tube–cap mix up
- Strips can be easily split into smaller sections by snapping apart
- Supplied in resealable bags
- Certified RNase, DNase, DNA and PCR Inhibitor free



PCR Strips with Individually Attached Caps				
Cat. No.	Description	Colour	Pack Size	Price
<b>Domed Caps</b>				
I1402-2900	<b>C</b> 0.2ml 8-Strip PCR Tubes, Individually Attached Domed Caps	Natural	120	£94.61
I1402-2908	0.2ml 8-Strip PCR Tubes, Individually Attached Domed Caps	Mixed*	5 x 24	£94.61
<b>Flat Caps (X-Clear)</b>				
A1402-3800	0.1ml 8-Strip Low-Profile PCR Tubes, Individually Attached Flat Caps (X-Clear)	Natural	120	£94.61
A1402-3700	<b>C</b> 0.2ml 8-Strip PCR Tubes, Individually Attached Flat Caps (X-Clear)	Natural	120	£94.61

\*Mixed packs contain: blue, green, red, violet, yellow.

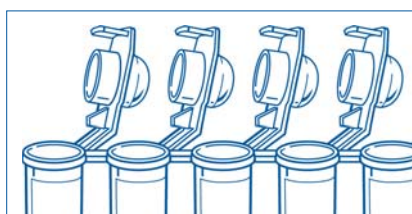

PCR Strips with Individually Attached Shielded Caps				
Cat. No.	Description	Colour	Pack Size	Price
S1602-2900	0.2ml 8-Strip PCR Tubes, Ind. Attached Domed Shielded Caps	Natural	120	£94.61

Integral shield on the cap prevents accidental finger contamination with the surface of the lid



PCR Strips with Attached Cap Strip				
Cat. No.	Description	Colour	Pack Size	Price
<b>Domed Caps</b>				
I1402-2800	0.2ml 8-Strip PCR Tubes, Attached Domed Cap Strip	Natural	125	£94.61
<b>X-Clear Flat Caps</b>				
I1402-2700	<b>C</b> 0.2ml 8-Strip PCR Tubes, Attached Flat Cap Strip (X-Clear)	Natural	125	£94.61

**C CASE SIZES (x10 packs) available at discount!** To order by the case, add **-C** to the end of the Cat. No.





# qPCR Strips

## White tubes and extra clear caps

### Ideal for qPCR!

White tubes maximise reflectance for enhanced signal and the extra clear caps allow optimal signal transmission and detection.

- Made from medical grade polypropylene
- Available in standard height (0.2ml), or in low-profile (0.1ml) to minimise the space above the PCR reaction and further reduce evaporation effects
- Supplied in resealable bags
- Certified RNase, DNase, DNA and PCR Inhibitor free



**New!**

**New!**

Strip Tube & Cap Combo Packs				
Cat. No.	Description	Colour	Pack Size	Price
11409-4700	0.1ml 8-Strip White PCR Tubes, Low-Profile and 8-Strip PCR Caps, Flat (X-Clear)	White/Natural	125 pairs	£80.00
11409-5700	0.2ml 8-Strip White PCR Tubes and 8-Strip PCR Caps, Flat (X-Clear)	White/Natural	125 pairs	£80.00

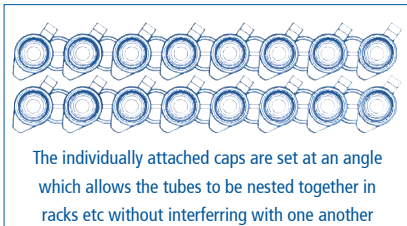

**Non-Flex** tubes have a robust, triple link between each tube making them less flexible and easier to handle. Individually attached caps eliminates the possibility of cross-contamination through accidental cap-tube mix ups.

8-Strip Non-Flex PCR Tubes with Individual Caps				
Cat. No.	Description	Colour	Pack Size	Price
<b>Low-Profile</b>				
11402-3800	0.1ml 8-Strip Low-Profile Non-Flex PCR Tubes, Individually Attached Flat Caps (X-Clear)	Natural / Natural	120	£94.61
11409-3800	0.1ml 8-Strip Low-Profile White Non-Flex PCR Tubes, Individually Attached Flat Caps (X-Clear)	White / Natural	120	£94.61
<b>Standard Height</b>				
11402-3700	0.2ml 8-Strip Non-Flex PCR Tubes, Individually Attached Flat Caps (X-Clear)	Natural / Natural	120	£94.61
11409-3700	0.2ml 8-Strip White Non-Flex PCR Tubes, Individually Attached Flat Caps (X-Clear)	White / Natural	120	£94.61

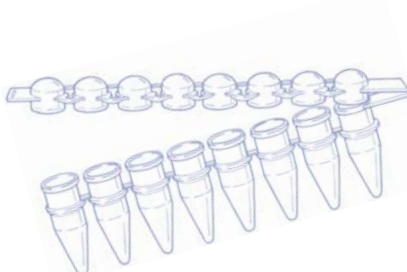

8-Strip PCR Tubes with Attached Cap Strip				
Cat. No.	Description	Colour	Pack Size	Price
11409-2700	0.2ml 8-Strip White PCR Tubes, Att. Flat Cap Strip (X-Clear)	White / Natural	125	£94.61

0.1ml 4-strip tubes and caps suitable for use with the Rotor-Gene® Q Real-Time PCR Cycler.

Rotor-Gene® Style Strip Tubes and Caps				
Cat. No.	Description	Colour	Pack Size	Price
11402-0400	0.1ml 4-Strip Rotor-Gene® Style Tubes and Caps	Natural	250	£66.78



# Non-Skirted PCR Plates

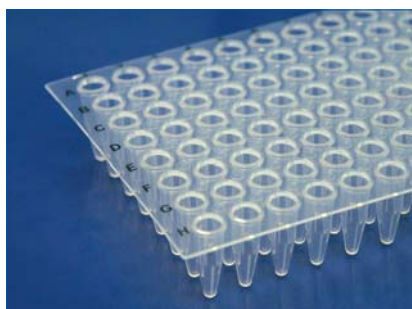

Non-skirted plates have highly-visible printed matrix (except B1402-0595 which has moulded matrix)

## Cuttable PCR plate

Standard height, non-skirted PCR plate. This plate is more pliable than other non-skirted plates and can easily be cut into any desired configuration.



E1403-0100

## Plate capacities

Approximate maximum capacity for all 96-well plates is 350µl for standard height plates, or 200µl for low-profile plates.

## CASE SIZES (100 plates)

**available at discount!** To order a case, add **-C** to the end of the Cat. No.

## Non-skirted PCR plates

- Non-skirted plates for a universal fit, suitable for most thermal cyclers
- Opaque white or black plates show low auto-fluorescence with chemiluminescence (white) or fluorescence (black) detectors. White plates also increase signal yield.
- Supplied in resealable bags
- Certified RNase, DNase, DNA and PCR Inhibitor free



Non-Skirted Plate						
Cat. No.	Description	Cut Corner	Colour	Pack Size	Price	
<b>Low-Profile</b>						
E1403-0200	<b>C</b> 96-Well PCR Plate, Non-Skirted, Low Profile	H12	Natural	20	£56.81	
E1403-0208	96-Well PCR Plate, Non-Skirted, Low Profile	H12	Black	20	£56.81	
E1403-0209	<b>C</b> 96-Well PCR Plate, Non-Skirted, Low Profile	H12	White	20	£56.81	
<b>Standard Height</b>						
E1403-1200	<b>C</b> 96-Well PCR Plate, Non-Skirted	A12	Natural	10	£28.98	
E1403-1208	96-Well PCR Plate, Non-Skirted	A12	Black	10	£28.98	
E1403-1209	<b>C</b> 96-Well PCR Plate, Non-Skirted	A12	White	10	£28.98	
<b>Standard Height, Cuttable</b>						
E1403-0100	<b>C</b> 96-Well PCR Plate, Non-Skirted (Cuttable)	A12	Natural	10	£28.98	
<b>Sealing Mat</b>						
E1403-0000	Silicone Sealing Mat (Autoclavable)		Natural	5	£26.78	

NOTE: Sealing mat E1403-0000 is not suitable for qPCR. Above plates can also be sealed with PCR strip caps (page 69), or the plate seals suitable for PCR (page 85). For an overview of PCR plate sealing options, see page 78.

Non-Skirted Plate (Flat Surface)						
Cat. No.	Description	Cut Corner	Colour	Pack Size	Price	
B1402-0595	96-Well PCR Plate, Non-Skirted (Flat Surface)	H12	Natural	10	£24.57	
<b>Sealing Mat</b>						
B1494-1005	Cap Mat for 96-Well PCR Plates (Autoclavable)		Blue	5	£38.96	

This plate has a moulded matrix. NOTE: Cap mat B1494-1005 is not suitable for qPCR. Above plate can also be sealed with the plate seals suitable for PCR (page 85). For an overview of PCR plate sealing options, see page 78.

## Silicone sealing mat (autoclavable)

Reusable, ultra-flexible silicone sealing mat for 96-well PCR Plates. Designed to be especially suitable for thermal cyclers with pressure-fit lids. Can be cut to size for use with 24, 32 or 48-well plates. The non-reactive rubber will withstand repeated autoclaving, extreme temperatures and aggressive chemicals.

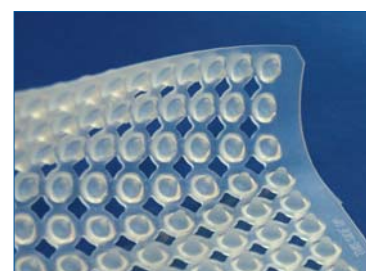

E1403-0000 £26.78 Pack of 5

## Non-Skirted PCR Plates



Non-skirted plates with elevated wells have highly-visible printed matrix

Non-Skirted Plates with Elevated Wells					
Cat. No.	Description	Cut Corner	Colour	Pack Size	Price
E1403-2200	96-Well PCR Plate, Non-Skirted, Elevated Wells	H12	Natural	10	£28.98
E1403-3200	48-Well PCR Plate, Non-Skirted, Elevated Wells		Natural	20	£35.60
E1403-4200	24-Well PCR Plate, Non-Skirted, Elevated Wells		Natural	40	£41.16
Sealing Mat					
E1403-0000	Silicone Sealing Mat (Autoclavable)		Natural	5	£26.78

NOTE: Sealing mat E1403-0000 is not suitable for qPCR. Above plates can also be sealed with PCR strip caps (page 69), or the plate seals suitable for PCR (page 85). For an overview of PCR plate sealing options, see page 78.

**New!**

## Barcoded PCR Plates



Barcoded plates have highly-visible printed matrix.

- Code 128 Barcoding plus human-readable number
- All barcodes seven digits long
- Low, minimum ordering quantity of 100 plates
- 96-well and 384-well plate options



Images for illustrative purposes only.

96-Well Semi-Skirted PCR Plates, Barcoded					
Cat. No.	Description	Cut Corner	Colour	Pack Size	Price
I1402-9800-BC	96-Well PCR Plate, Semi-Skirted, Straight Edges, with Barcode	A12	Natural	10x10	£330.75
I1402-9909-BC	96-Well PCR Plate, Semi-Skirted, for Roche® Lightcycler, with Barcode	H12	White	10x10	£330.75
E1403-8200-BC	96-Well PCR Plate, Semi-Skirted, Raised Rim, with Barcode	A12	Natural	10x10	£330.75

96-Well Skirted PCR Plate, Barcoded					
Cat. No.	Description	Cut Corner	Colour	Pack Size	Price
E1403-5200-BC	96-Well PCR Plate, Skirted, Low-Profile, with Barcode	A12	Natural	10x10	£330.75

384-Well Skirted PCR Plates, Barcoded					
Cat. No.	Description	Cut Corner	Colour	Pack Size	Price
E1042-3840-BC	384-Well PCR Plate, ABI/Universal-Style, Skirted, with Barcode	A24	Natural	10x10	£430.50
E1042-9900-BC	384-Well PCR Plate for Roche Lightcycler, Skirted, with Barcode	A24/P24	Natural	10x10	£430.50

### Customised barcoding is also available

If you require a specific sequence start to your barcoding or require barcoding on plates other than those shown above, we can provide you with a quote for customised barcoding. Note that the minimum order quantity for custom barcoding is 2000 plates. Contact STARLAB or your Account Manager for more details.

# Semi-Skirted PCR Plates

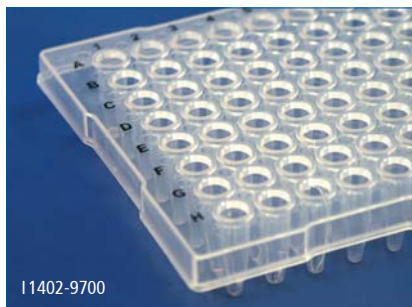

Semi-skirted plates with highly-visible printed matrix

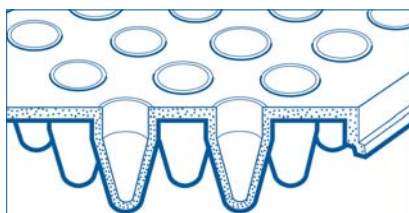

**New!**

### Plate capacities

Approximate maximum capacity for all 96-well plates is 350µl for standard height plates, or 200µl for low-profile plates.

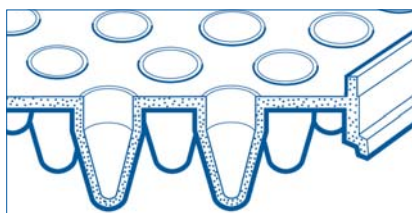

### Semi-skirted PCR plates

- Opaque white or black plates show low auto-fluorescence with chemiluminescence (white) or fluorescence (black) detectors. White plates also increase signal yield
- Specialist plates (for FAST® Systems, qPCR)
- Supplied in resealable bags
- Certified RNase, DNase, DNA and PCR Inhibitor free



Semi-Skirted Plates					
Cat. No.	Description	Cut Corner	Colour	Pack Size	Price
<b>Low Profile</b>					
E1403-6200	<b>C</b> 96-Well PCR Plate, Semi-Skirted, Low Profile	A12	Natural	10	£28.98
E1403-6208	96-Well PCR Plate, Semi-Skirted, Low Profile	A12	Black	10	£28.98
E1403-6209	<b>C</b> 96-Well PCR Plate, Semi-Skirted, Low Profile	A12	White	10	£28.98
<b>Standard Height</b>					
11402-9700	<b>C</b> 96-Well PCR Plate, Semi-Skirted	A12	Natural	10	£28.98
11402-9701	96-Well PCR Plate, Semi-Skirted	A12	Blue	10	£28.98
11402-9708	<b>C</b> 96-Well PCR Plate, Semi-Skirted	A12	Black	10	£28.98
11402-9709	96-Well PCR Plate, Semi-Skirted	A12	White	10	£28.98
11402-9800	96-Well PCR Plate, Semi-Skirted, Straight Edges	A12	Natural	10	£28.98
11402-9809	<b>C</b> 96-Well PCR Plate, Semi-Skirted, Straight Edges	A12	White	10	£28.98
11402-9909	<b>C</b> 96-Well PCR Plate, Semi-Skirted, for Roche® Lightcycler®	H12	White	10	£28.98
<b>Sealing Mat</b>					
E1403-0000	Silicone Sealing Mat (Autoclavable)		Natural	5	£26.78

NOTE: Sealing mat E1403-0000 is not suitable for qPCR. Above plates can also be sealed with PCR strip caps (page 69), or the plate seals suitable for PCR (page 85). For an overview of PCR plate sealing options, see page 78.

### Semi-Skirted Plates with Raised Rim

Cat. No.	Description	Cut Corner	Colour	Pack Size	Price
<b>TAQMan®-Style Plate</b>					
E1403-8200	<b>C</b> 96-Well PCR Plate, Semi-Skirted, Raised Rim	A12	Natural	10	£28.98
E1403-8209	96-Well PCR Plate, Semi-Skirted, Raised Rim	A12	White	10	£28.98
<b>Plate for FAST® Systems</b>					
E1403-7700	<b>C</b> 96-Well PCR Plate, Semi-Skirted, Raised Rim, Low Profile (for FAST® Systems)	A1	Natural	10	£26.67
E1403-7709	<b>C</b> 96-Well PCR Plate, Semi-Skirted, Raised Rim, Low Profile (for FAST® Systems)	A1	White	10	£28.98
<b>Sealing Mat</b>					
E1403-0000	Silicone Sealing Mat (Autoclavable)		Natural	5	£26.78

NOTE: Sealing Mat E1403-0000 is not suitable for qPCR. Above plates can also be sealed with PCR strip caps (page 69), or the plate seals suitable for PCR (page 85). For an overview of PCR plate sealing options, see page 78.

### **C** CASE SIZES (100 plates)

**available at discount!** To order a case, add **-C** to the end of the Cat. No.



# Skirted PCR Plates

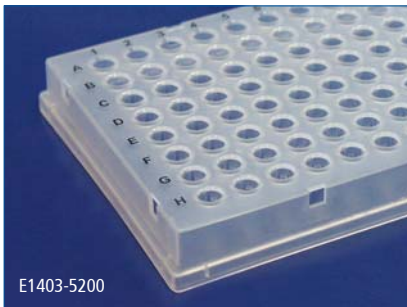

E1403-5200

96-well skirted plates with highly-visible printed matrix

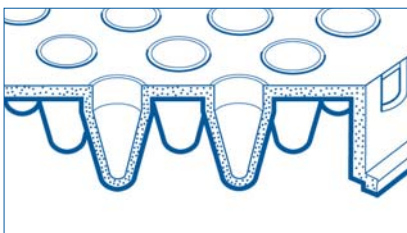

**FREE SAMPLE**  
**TRY**  
before you  
**BUY**  
available on request

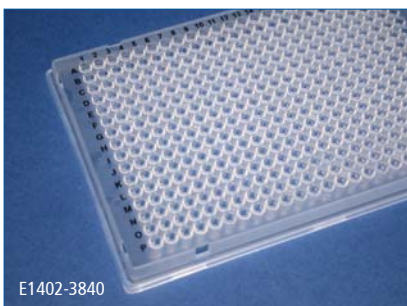

E1402-3840

384-well skirted plates have a highly visible printed matrix (except E1042-2500 and E1042-3000 which both have a moulded matrix)

## 96-well skirted PCR plates

- Opaque white or black plates show low auto-fluorescence with chemiluminescence (white) or fluorescence (black) detectors. White plates also increase signal yield
- Holes on sides for robotics handling
- Supplied in resealable bags
- Certified RNase, DNase, DNA and PCR Inhibitor free



96-Well, Skirted Plates					
Cat. No.	Description	Cut Corner	Colour	Pack Size	Price
E1403-5200	<b>C</b> 96-Well PCR Plate, Skirted, Low Profile	A12	Natural	10	£28.98
E1403-5208	96-Well PCR Plate, Skirted, Low Profile	A12	Black	10	£28.98
E1403-5209	96-Well PCR Plate, Skirted, Low Profile	A12	White	10	£28.98
E1403-5300	96-Well PCR Plate, Skirted, Low Profile, for MegaBACE®	H1	Natural	10	£28.98
Sealing Mat					
E1403-0000	Silicone Sealing Mat (Autoclavable)		Natural	5	£26.78

NOTE: Sealing mat E1403-0000 is not suitable for qPCR. Above plates can also be sealed with PCR strip caps (page 69), or the plate seals suitable for PCR (page 85). For an overview of PCR plate sealing options, see page 78.

## 384-well skirted PCR plates

- Opaque white plates for qPCR
- Holes on sides for robotics handling
- Supplied in resealable bags
- Certified RNase, DNase, DNA and PCR Inhibitor free

384-Well Skirted Plates					
Cat. No.	Description	Cut Corner	Colour	Pack Size	Price
E1042-3840	<b>C</b> 384-Well PCR Plate, Skirted, ABI®/Universal-Style	A24	Natural	10	£50.09
E1042-3849	384-Well PCR Plate, Skirted, ABI®/Universal-Style	A24	White	10	£50.09
E1042-9909	<b>C</b> 384-Well PCR Plate, Skirted, for Roche® Lightcycler®	A24,P24	White	10	£60.17
E1042-2500	<b>C</b> 384-Well PCR Plate, Skirted (40µl)	A24,P24	Natural	10	£33.39
E1042-3000	384-Well PCR Plate, Skirted (35µl)	A24	Natural	10	£33.39
Sealing Mat					
E1042-2350	Silicone Sealing Mat for 384-Well Plates		Natural	10	£27.83

NOTE: Sealing mat E1042-2350 is not suitable for qPCR. Above plates can also be sealed the plate seals suitable for PCR (page 85). For an overview of PCR plate sealing options, see page 78. Volumes stated are to the brim of the well and are approximate only.

**C CASE SIZES (100 plates)**  
**available at discount!** To order a case, add **-C** to the end of the Cat. No.

# PCR Plate–Cycler Compatibility



Raised Rim:  
Elevated Wells:  
Low-Profile:  
No. of Wells:  
  
Cat. No.:

**APPLIED BIOSYSTEMS**

		E1403-3200	B1402-0595	E1403-0100	E1403-0200*	E1403-1200*	E1403-2200*	E1403-6200*	E1403-7700*	E1403-8200*	11402-9700*	11402-9800*	11402-9909	E1403-5200*	E1403-5300	E1042-2500	E1042-3000	E1042-3840*	E1042-9909		
Thermal Cyclers	2700		✓	✓		✓	✓			✓	✓										
	2720 and 6100									✓	✓										
	9600		✓	✓		✓	✓			✓	✓	✓									
	9700		✓	✓		✓	✓			✓	✓	✓									
	9800 FAST								✓												
	Veriti 0.1ml								✓												
	Veriti 0.2ml									✓			✓								
	Veriti 384																			✓	
Real-Time Thermal Cyclers	5700, 7300, 7500			✓		✓				✓	✓	✓					✓	✓	✓		
	PRISM 7000			✓		✓				✓	✓	✓									
	7500 FAST								✓												
	7700			✓		✓				✓	✓	✓									
	7900 HT			✓		✓		✓		✓	✓	✓									
	7900 HT FAST								✓												
	7900 HT 384 Well																			✓	
	Quant Studio 12K Flex									✓	✓									✓	
	StepOne	✓																			
	StepOne Plus									✓											
	viiA7									✓	✓										✓
Sequencers	PRISM 310			✓		✓	✓	✓	✓	✓	✓	✓									
	PRISM 3100			✓		✓	✓	✓	✓	✓	✓	✓								✓	
	3130 (XL)			✓		✓	✓	✓	✓	✓	✓	✓								✓	
	3500 (XL)									✓	✓	✓								✓	
	3700			✓		✓	✓	✓	✓	✓	✓	✓								✓	
	PRISM 3730(XL)			✓		✓	✓	✓	✓	✓	✓	✓								✓	

**AMERSHAM**

Sequencers	MegaBACE 500													✓	✓					
	MegaBACE 1000						✓ <sup>1</sup>							✓						
	MegaBACE 4000																			✓

**BECKMAN**

Sequencers	CEQ			✓		✓														
------------	-----	--	--	---	--	---	--	--	--	--	--	--	--	--	--	--	--	--	--	--

**BIOMETRA**

Thermal Cyclers	Uno		✓	✓	✓	✓	✓				✓	✓		✓						
	Uno II, T1 Thermocycler, Trobot		✓	✓	✓	✓	✓				✓	✓					✓	✓	✓	
	Tgradient		✓	✓	✓	✓	✓				✓	✓		✓						
	T3000 & TProfessional				✓	✓	✓							✓						✓
Real-Time	Topical			✓	✓	✓							✓							✓

**BIO-RAD/MJ RESEARCH**

Thermal Cyclers	C1000/S1000	✓		✓	✓	✓					✓			✓						✓
	DNA Engine range			✓	✓	✓					✓			✓						✓
	Dyad / Dyad Disciple		✓	✓	✓	✓	✓				✓			✓				✓	✓	
	Gene Cyclor			✓		✓	✓			✓	✓									
	iCYCLER		✓	✓		✓	✓				✓			✓						
	Mini Gradient			✓	✓	✓														
	MyCycler			✓		✓	✓					✓								
	Personal			✓		✓	✓					✓								
	PTC-100, PTC-200, PTC 225-Tetrad		✓	✓	✓	✓	✓					✓			✓				✓	✓
	T100			✓		✓								✓						
Real-Time Thermal Cyclers	OPTICON / OPTICON 2			✓	✓	✓								✓						
	CFX96													✓						
	CFX384																			✓
	CFX Connect					✓						✓		✓						
	Chromo-4					✓						✓		✓						
	iCycler			✓		✓	✓					✓		✓						✓
Sequencer	iQ5 & MyiQ			✓		✓	✓				✓		✓							
	BaseStation												✓							

<sup>1</sup> Suitable for use on machines manufactured before July 2000 only.

# PCR Plate–Cycler Compatibility

**FREE SAMPLE**  
**TRY**  
before you  
**BUY**  
available on request



Raised Rim:  
Elevated Wells:  
Low-Profile:  
No. of Wells:

Cat. No.:

**CORBETT**

Thermal Cyclers	PalmCycler 96		✓																	
	PalmCycler 384																		✓	✓

**EPPENDORF**

Thermal Cyclers	Mastercycler			✓	✓	✓	✓					✓		✓							
	Mastercycler ep Gradient		✓	✓	✓	✓	✓				✓	✓		✓							
	Mastercycler Nexus & Nexus Eco			✓	✓	✓	✓					✓		✓							
	Mastercycler Nexus Gradient			✓	✓	✓	✓					✓		✓							
	Mastercycler Personal		✓																		
	Mastercycler Pro			✓			✓						✓		✓						✓
Real-Time	Mastercycler M384																	✓	✓	✓	
Real-Time	Mastercycler ep Realplex			✓		✓				✓	✓		✓		✓						

**ERICOM**

Thermal Cyclers	Delta Cycler I		✓	✓	✓	✓	✓					✓									
	Delta Cycler II		✓	✓	✓	✓	✓	✓			✓	✓									
	Power Block I			✓	✓	✓	✓	✓	✓												
	Single Block & Twin Block		✓	✓	✓	✓	✓	✓					✓								

**ESCO / FLEXI**

Thermal Cyclers	Swift			✓		✓	✓					✓								✓
	Gene			✓		✓	✓					✓							✓	✓
	Genius			✓		✓	✓					✓						✓	✓	✓

**G-STORM**

Thermal Cyclers	GS1, GS2 & GS4			✓	✓	✓	✓	✓			✓	✓	✓							
	GSX & GSXs			✓	✓	✓	✓	✓			✓	✓	✓							

**MWG**

Thermal Cyclers	Primus 96		✓	✓	✓	✓	✓			✓	✓	✓		✓						
	Primus 384																		✓	✓

**ROCHE**

Real-Time	LightCycler 480													✓						✓
-----------	-----------------	--	--	--	--	--	--	--	--	--	--	--	--	---	--	--	--	--	--	---

**STRATAGENE**

Thermal Cyclers	Robocycler 96		✓	✓		✓						✓								
	Robocycler Gradient			✓	✓	✓	✓	✓			✓	✓	✓		✓					
	SureCycler 8800				✓															
Real-Time	Mx3005P & Mx4000			✓	✓	✓	✓	✓			✓	✓								

**TaKaRa**

Thermal Cyclers	TP240																			✓
	TP3000		✓	✓	✓	✓	✓	✓			✓	✓	✓		✓					✓

**Techne**

Thermal Cyclers	Cyclogene		✓	✓	✓	✓	✓	✓			✓	✓	✓								
	Genius & Genius Quad		✓	✓	✓	✓	✓	✓			✓	✓	✓								
	Genius (TC412)			✓	✓	✓	✓	✓				✓	✓	✓		✓					
	Flexigene			✓	✓	✓	✓	✓				✓	✓	✓		✓					✓
	Touchgene		✓	✓	✓	✓	✓	✓				✓	✓	✓		✓					
	Touchgene X			✓	✓	✓	✓	✓				✓	✓	✓		✓			✓	✓	✓
Real-Time	Touchgene Gradient (TC512)			✓	✓	✓	✓	✓			✓	✓	✓		✓			✓	✓	✓	
Real-Time	Quantica				✓									✓							

**THERMO HYBAID**

Thermal Cyclers	PCR Sprint			✓	✓	✓	✓	✓			✓	✓	✓		✓					
	MBS Satellite (Multiblock) System			✓	✓	✓	✓	✓			✓	✓	✓		✓			✓	✓	✓
	Px2 & PxE			✓	✓	✓	✓	✓			✓	✓	✓		✓			✓	✓	✓
	PCR Express & Omni-E		✓	✓	✓	✓	✓	✓			✓	✓	✓		✓			✓	✓	✓
	Touchdown & Omnigene		✓	✓	✓	✓	✓	✓			✓	✓	✓		✓			✓	✓	✓

**TRANSGENOMIC**

Sequencer	WAVE System																			✓
-----------	-------------	--	--	--	--	--	--	--	--	--	--	--	--	--	--	--	--	--	--	---

The individual cycler-plate combinations are intended as a guide only, with no guarantee. Samples of all plates are readily available before purchase so you can confirm compatibility. Low-profile and 384-well plates are compatible with their designated thermal blocks only. STARLAB recognises that the trade names of all cyclers and sequencers in this table belong to their respective owners. \*Cat. No. of natural plate shown only. These plates are also available in opaque black and/or white and will fit the same thermal cyclers. See relevant pages for ordering details.

# PCR Plate–Sealing Overview



Flat caps enable labelling while domed caps provide the most secure seal when using thermal cyclers with a screw down lid. Use the flat, 'X-Clear' strip caps in Real-Time (qPCR) applications as these exceptionally clear caps allow the fluorescence signal to pass through.

For ordering details, see page 69.

For an optimum and consistent seal across the whole plate, use the seal applicator or sealing brayer on page 86.

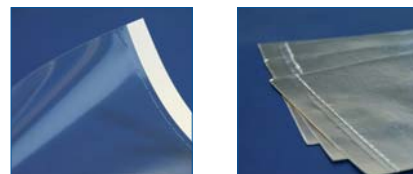

## Heat seals

All heat seals offered by STARLAB are suitable for PCR and one has superior optical clarity and is suitable for Real-Time PCR.

All plate seal specifications and ordering details are on page 85.

### Important note for Real-Time PCR (qPCR)

Please check that both the plate AND the sealing option are suitable for Real-Time PCR applications.

**Plates** See the Plate–Cycler Compatibility chart on pages 76–77 to see which plate is suitable for your Real-Time Cycler.

**Strip caps** Use only the 'X-Clear' strip caps on your plates for Real-Time PCR applications.

**Plate seals** Only those seals with superior optical clarity can be used for Real-Time applications. Choose between a self-adhesive seal or a heat seal – see page 85 for details.

**NOTE:** Sealing mats are NOT suitable for Real-Time applications.

## What are my sealing options?

### For 24-well plates

- 8-strip caps

### For 48-well plates

- 8-strip caps

### For 96-well plates

- 8-strip caps
- 12-strip caps
- Sealing mats for 96-well plates
- Plate seals (unless plate has raised wells)

### For 384-well plates

- Sealing mats for 384-well plates
- Plate seals

## Sealing mats

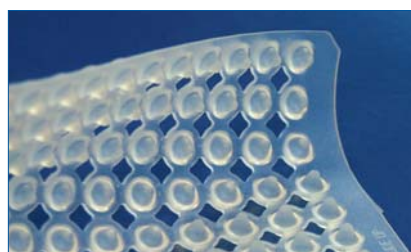

Particularly suitable for thermal cyclers with pressure-fit lids, silicone mats are very flexible, autoclavable and reusable. The mats can also be cut to size for use with 24 or 48-well plates. **NOTE:** Sealing mats are not suitable for real-time applications.

For ordering details, see pages 72–75.

## Strip caps



8- and 12-strip caps are manufactured from pure polypropylene, are available flat or domed, and are suitable for use with all 96-well PCR plates. (8-strip caps only can be used on 24- and 48-well plates). Strip caps allow the convenience of unsealing one row of plate wells at a time.

## Plate seals

Plate seals are quick both to apply and to remove.

## Self-adhesive seals

Three self-adhesive seals (aluminium, clear polypropylene and clear polyolefin) offered by STARLAB are suitable for standard PCR. The X-Clear Advanced Polyolefin Seal is suitable for Real-Time PCR and the seal's superior optical clarity yields consistent results.



# PlateOne® Deepwell Plates



- Virgin polypropylene plates
- Highly visible, printed matrix
- SBS footprint
- Barcoded plates available on request
- Temperature use: -80°C to 121°C
- Autoclavable
- Rated up to 5000 x g
- Packed in resealable zipper bags
- Certified RNase, DNase & DNA free
- Sterile plates are also Pyrogen free

## PlateOne

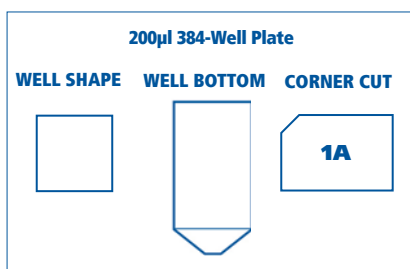
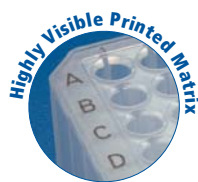
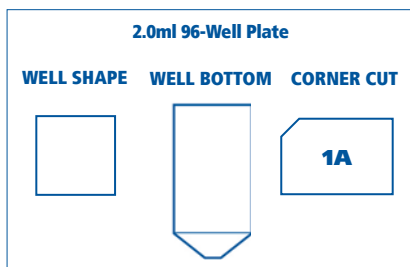
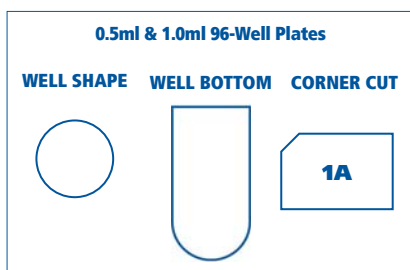

### 96 Deepwell Plates

Cat. No.	Description	Pack Size	Price
<b>0.5ml, Round Wells, Round Bottom</b>			
S1896-5800	0.5ml 96 Deepwell Plate, Round Wells with Round Bottoms	4 x 8	£112.98
S1896-5000	0.5ml 96 Deepwell Plate, Round Wells with Round Bottoms (Bulk)	32	£102.38
S1896-5110	0.5ml 96 Deepwell Plate, Round Wells with Round Bottoms (Sterile), Individually Wrapped	32	£133.56
B1494-1224	DMSO Resistant Polyolefin Sealing Mat for 96-Well with Round Wells	24	£89.04
<b>1.0 ml, Round Wells, Round Bottom</b>			
S1896-1800	1.0ml 96 Deepwell Plate, Round Wells with Round Bottoms	4 x 5	£71.19
S1896-1000	1.0ml 96 Deepwell Plate, Round Wells with Round Bottoms (Bulk)	20	£66.78
S1896-1110	1.0ml 96 Deepwell Plate, Round Wells with Round Bottoms (Sterile), Individually Wrapped	20	£84.63
B1494-1224	DMSO Resistant Polyolefin Sealing Mat for 96-Well with Round Wells	24	£89.04
<b>2.0 ml, Square Wells, V-Shaped Bottom</b>			
S1896-2800	2.0ml 96 Deepwell Plate, Square Wells with V-Shape Bottoms	4 x 5	£84.63
S1896-2000	2.0ml 96 Deepwell Plate, Square Wells with V-Shape Bottoms (Bulk)	20	£75.71
S1896-2110	2.0ml 96 Deepwell Plate, Square Wells with V-Shape Bottoms (Sterile), Individually Wrapped	20	£93.45
B1494-1124	DMSO Resistant Polyolefin Sealing Mat for 96-Well with Square Wells	24	£89.04
E2896-1801	Piercable Sealing Mat for 96-Well with Square Wells	5	£28.98

Plate Dimensions (WxDxH): 0.5ml: 127.8 x 85.5 x 14.35mm. 1.0ml & 2ml: 127.8 x 85.5 x 44.10mm.

#### Sealing Options

All PlateOne® Plates can be sealed with the designated sealing mats listed, or with the plate seals on page 85

### 384 Deepwell Plates

Cat. No.	Description	Pack Size	Price
<b>200µl, Square Wells, V-Shaped Bottom</b>			
S1884-2400	200µl 384 Deepwell Plate, Square Wells with V-Shape Bottoms	4 x 10	£169.16
S1884-2000	200µl 384 Deepwell Plate, Square Wells with V-Shape Bottoms (Bulk)	40	£155.82
S1884-2410	200µl 384 Deepwell Plate, Square Wells with V-Shape Bottoms (Sterile), Individually Wrapped	40	£195.93
B1494-1024	Autoclavable, DMSO Resistant Sealing Mat for 384-Well Plates with Square Wells, Blue	24	£105.74

Plate Dimensions (WxDxH): 127.8 x 85.5 x 25.10mm.

# 96-Well Deepwell Plates



## Features

- Virgin polypropylene plates with SBS footprint
- Alpha-numeric reference grid (moulded)
- Pierceable mats reseal after use
- The chemically resistant mats can be used with DMSO and other solvents
- Plate temperature use: -80°C to 121°C.
- All plates are autoclavable

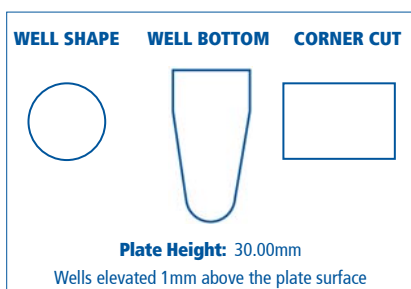

0.6ml, Low-Profile, Round Wells			
Cat. No.	Description	Pack Size	Price
E2896-0600	0.6ml 96 Deepwell Plate, Round Wells with Conical Bottoms	5	£12.29

Certified RNase and DNase free.

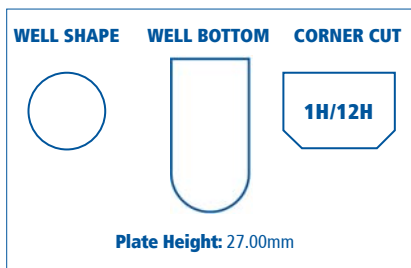

1.1ml, Low-Profile, Round Wells (Sterile)			
Cat. No.	Description	Pack Size	Price
E2896-0110	1.1ml 96 Deepwell Plate, Round Wells with Round Bottoms, Low-Profile (Sterile)	2 x 5	£33.39

### Sealing Mats

E2896-1100	Pierceable, Autoclavable Silicone Sealing Mat for 96 Deepwell Plates with Round Wells	10	£27.83
E2896-1110	Pierceable, Autoclavable Silicone Sealing Mat for 96 Deepwell Plates with Round Wells (Sterile)	2 x 5	£33.39
E2896-2200	Chemically Resistant, Autoclavable Silicone Sealing Mat for 96 Deepwell Plates with Round Wells	10	£44.52

Certified RNase and DNase free.

**New!**

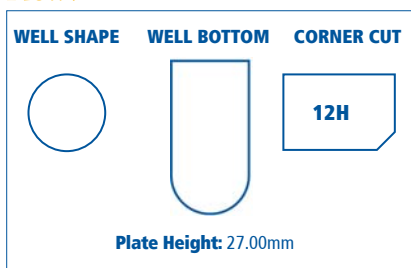

1.2ml, Low-Profile, Round Wells			
Cat. No.	Description	Pack Size	Price
E2896-0120	1.2ml 96 Deepwell Plate, Round Wells with Round Bottoms, Low-Profile	50	£125.00

### Sealing Options

E2896-0320	Pierceable TPE Sealing Mat for 1.2ml/2.2ml 96 Deepwell Plates, Round Wells	50	£115.00
E2896-0000	Pierceable TPE 8-Strip Caps for 96 Deepwell Plates with Round Wells	1000 Strips	£165.00

## Deepwell plate sealing options

Deepwell plates can be sealed with the sealing mat listed in the plate's ordering table, or with the plate seals on page 85. See also, the universal PP lid for all SBS plates on page 82

**FREE SAMPLE**  
**TRY**  
before you  
**BUY**  
available on request

# 96-Well Deepwell Plates

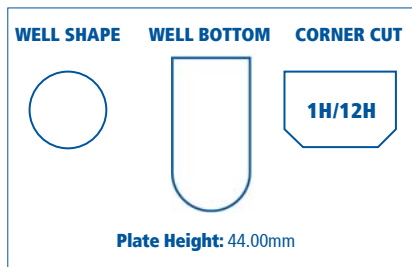

**New!**

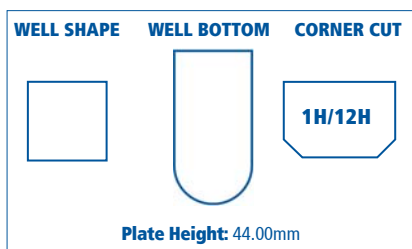
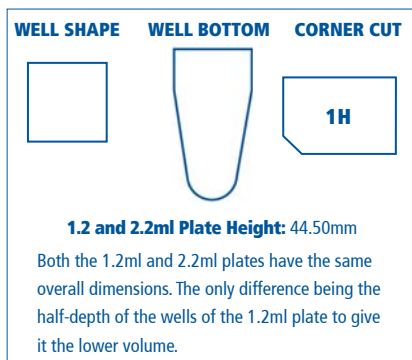
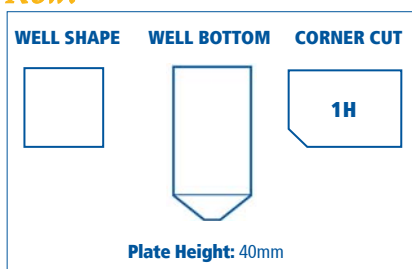

**New!**

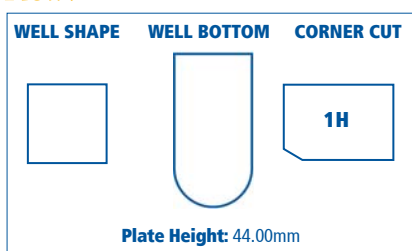

## 2.0ml, Round Wells

Cat. No.	Description	Pack Size	Price
E2896-2100	2.0ml 96 Deepwell Plate, Round Wells with Round Bottoms,	10	£36.75
E2896-2110	2.0ml 96 Deepwell Plate, Round Wells with Round Bottoms (Sterile)	2 x 5	£46.73

## Sealing Mats

E2896-1100	Piercable, Autoclavable Silicone Sealing Mat for 96 Deepwell Plates with Round Wells	10	£27.83
E2896-1110	Piercable, Autoclavable Silicone Sealing Mat for 96 Deepwell Plates with Round Wells (Sterile)	2 x 5	£33.39
E2896-2200	Chemically Resistant, Autoclavable Silicone Sealing Mat for 96 Deepwell Plates with Round Wells	10	£44.52

Certified RNase and DNase free.

## 2.2ml, Square Wells

Cat. No.	Description	Pack Size	Price
E2896-0220	2.2ml 96 Deepwell Plate, Square Wells with V-Shaped Bottoms	50	£135.00

## Sealing Options

E2896-2501	Piercable TPE Sealing Mat for 2.2/2.5ml 96 Deepwell Plates with Square Wells	20	£20.00
------------	--	----	--------

## 1.1ml and 2.2ml, Square Wells

Cat. No.	Description	Pack Size	Price
<b>1.2ml Deepwell Plate</b>			
E2896-1820	1.2ml 96 Deepwell Plate, Square Wells with Conical Bottoms	10	£27.83

<b>2.2ml Deepwell Plate</b>			
E2896-1810	2.2ml 96 Deepwell Plate, Square Wells with Conical Bottoms	10	£31.19

## Sealing Mat

E2896-1801	Piercable, Autoclavable Silicone Sealing Mat for 1.2ml and 2.2ml 96 Deepwell Plates with Square Wells	5	£28.98
------------	---	---	--------

Certified RNase and DNase free.

## 2.0ml, Square Wells (Sterile)

Cat. No.	Description	Pack Size	Price
E2896-0210	2.0ml 96 Deepwell Plate, Square Wells with Round Bottoms (Sterile)	5 x 5	£120.23

## Sealing Mat

E2896-1200	Piercable, Autoclavable Silicone Sealing Mat for 96 Deepwell Plates with Square Wells	10	£27.83
------------	---	----	--------

Certified RNase and DNase free.

## 2.5ml, Square Wells

Cat. No.	Description	Pack Size	Price
E2896-2500	2.5ml 96 Deepwell Plate, Square Wells with Round Bottoms	20	£100.00

## Sealing Mat

E2896-2501	Piercable TPE Sealing Mat for 2.2/2.5ml 96 Deepwell Plates with Square Wells	20	£20.00
------------	--	----	--------

## 24-Well Deepwell Plates

New!

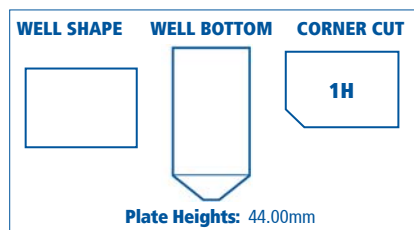

### 10ml, Rectangle Wells

Cat. No.	Description	Pack Size	Price
E2824-0000	10ml 24 Deepwell Plate, Rectangle Wells with V-Shape Bottoms	20	£125.00
E2824-0001	Pierceable TPE Sealing Mat for 10ml 24 Deepwell Plate	20	£66.00

Can be sealed with the sealing mat listed above, or with the plate seals on page 85. See also, Universal PP Lid listed below.

## 48-Well Deepwell Plates

New!

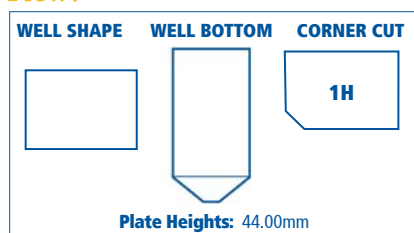

### 5.0ml, Rectangle Wells

Cat. No.	Description	Pack Size	Price
E2848-0000	5.0ml 48 Deepwell Plate, Rectangle Wells with V-Shape Bottoms	20	£125.00
E2848-5010	5.0ml 48 Deepwell Plate, Rectangle Wells with V-Shape Bottoms (Sterile)	2 x 5	£100.17

#### Sealing Mat

E2848-0001	Pierceable TPE Sealing Mat for 5.0ml 48 Deepwell Plates	20	£66.00
------------	---	----	--------

Can be sealed with the sealing mat listed above, or with the plate seals on page 85. See also, Universal PP Lid listed below.

## 384-Well Deepwell Plates

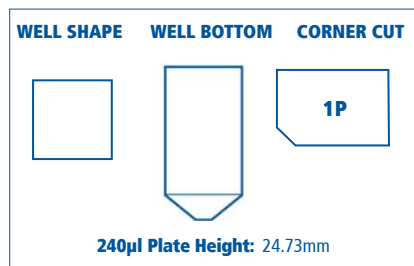

### 240µl, Square Wells

Cat. No.	Description	Pack Size	Price
<b>240µl 384-Well Plate</b>			
E2384-2400	240µl 384 Deepwell Plate, Square Wells with V-Shape Bottoms	10	£40.11
<b>Sealing Mats</b>			
E2384-1000	Pierceable, Autoclavable Silicone Sealing Mat for 384 Deepwell Plates with Square Wells (Autoclavable)	10	£27.83
E2384-2000	Chemically Resistant, Autoclavable Silicone Sealing Mat for 384 Deepwell Plates with Square Wells (Autoclavable)	10	£44.52

These plates are certified RNase and DNase free. Can be sealed with the sealing mat listed above, or with the plate seals on page 85. See also, Universal PP Lid listed below.

## Lid for SBS Plates

### Polypropylene lid

Polypropylene lid for use with all SBS format plates and robotic reservoirs.



### Universal Lid for SBS Plates

Cat. No.	Description	Pack Size	Price
E2999-0000	Universal PP Lid for all SBS Plates and Robotic Reservoirs	2 x 50	£94.61

# PlateOne® Microplates

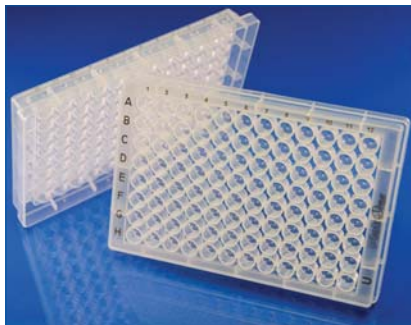

Well-bottom shape indicator code on every plate for easy identification



PlateOne® microplates are available in five styles, all with a highly-visible solvent-resistant, alpha-numeric matrix. These high-clarity polypropylene plates offer excellent sample recovery compared to polystyrene plates.

All plates conform to the SBS standard for compatibility with your automated equipment. They are certified free of detectable RNase, DNase and DNA. The sterile plates are also certified non-pyrogenic.

## Features

- Virgin polypropylene plates for reduced sample binding compared to polystyrene plates
- High chemical resistance
- Raised wells help prevent cross contamination (96-well plates)
- Highly visible printed, alpha-numeric matrix
- SBS footprint
- Certified RNase, DNase and DNA free. Sterile plates are also Pyrogen free

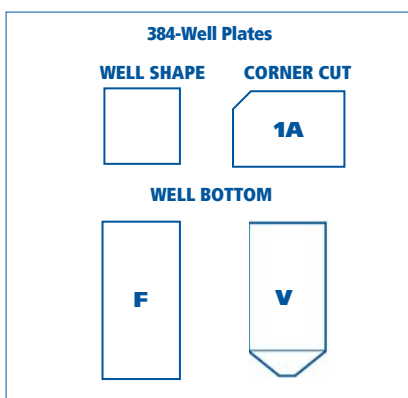
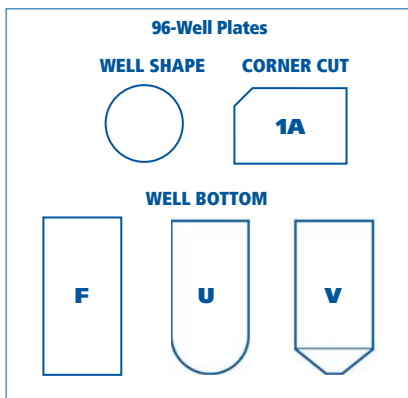

96-Well Microplates			
Cat. No.	Description	Pack Size	Price
<b>Flat Bottom (F) Plates, max. Working Volume 370µl</b>			
S1837-9600	96-Well Microplate, Round Wells with Flat Bottoms,	4 x 20	£122.43
S1837-9610	96-Well Microplate, Round Wells with Flat Bottoms (Sterile)	4 x 20	£137.97
<b>Round Bottom (U) Plates, max. Working Volume 320µl</b>			
S1830-9600	96-Well Microplate, Round Wells with Round Bottoms	4 x 20	£122.43
S1830-9610	96-Well Microplate, Round Wells with Round Bottoms (Sterile)	4 x 20	£137.97
<b>V-Shape Bottom (V) Plates, max. Working Volume 320µl</b>			
S1833-9600	96-Well Microplate, Round Wells with V-Shape Bottoms	4 x 20	£122.43
S1833-9610	96-Well Microplate, Round Wells with V-Shape Bottoms (Sterile)	4 x 20	£137.97
<b>Sealing Mat</b>			
B1494-1224	DMSO Resistant Polyolefin Sealing Mat for 96-Well Plates with Round Wells	24	£89.04

Plate dimensions (WxDxH): 127.8 x 85.5 x 14.35mm.

384-Well Microplates			
Cat. No.	Description	Pack Size	Price
<b>Flat Bottom (F) Plates, max. Working Volume 140 µl</b>			
S1843-8400	384-Well Microplate, Square Wells with Flat Bottoms	4 x 20	£163.59
S1843-8410	384-Well Microplate, Square Wells with Flat Bottoms (Sterile)	4 x 20	£172.52
<b>V-Shape Bottom (V) Plates, max. Working Volume 125 µl</b>			
S1823-8400	384-Well Microplate, Square Wells with V-Shape Bottoms	4 x 20	£163.59
S1823-8410	384-Well Microplate, Square Wells with V-Shape Bottoms (Sterile)	4 x 20	£172.52

Plate dimensions (WxDxH): 127.8 x 85.5 x 14.35mm.

# Polystyrene Microplates



## Ultra clear polystyrene microplates

96-well microplates made from crystal clear polystyrene (PS). The plates are available in a choice of three different well bottoms: flat (suitable for optical reading eg. non-UV spectrophotometers, and ELISA applications when pre-treated plates are not required), and round and v-shaped (suitable when total sample recovery is required).

Choose from aseptically produced plates in convenient mini-packs or individually-wrapped, sterile (irradiated) plates. Lids available separately.

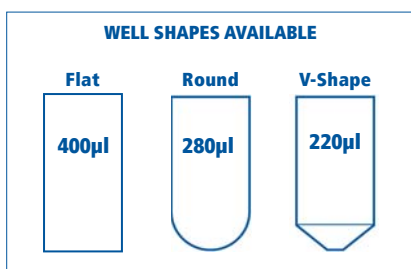

**Sealing options:** Polystyrene microplates can also be sealed with plate seals suitable for PS plates on page 85

**FREE SAMPLE TRY before you BUY**  
available on request

Polystyrene Microplates			
Cat. No.	Description	Pack Size	Price
<b>Sterile<sup>1</sup></b>			
E2996-1600	96-Well Microplate, Round Wells, Flat Bottom, PS (Sterile <sup>1</sup> )	20 x 5	£40.11
E2996-1700	96-Well Microplate, Round Wells, Round Bottom, PS (Sterile <sup>1</sup> )	20 x 5	£38.96
E2996-1800	96-Well Microplate, Round Wells, V-Shape Bottom, PS (Sterile <sup>1</sup> )	20 x 5	£38.96
E2996-1900	PS Lid for 96-Well PS Microplates (Sterile <sup>1</sup> )	20 x 5	£38.96
<b>Sterile, Individually-Wrapped</b>			
E2996-1610	96-Well Microplate, Round Wells, Flat Bottom, PS (Sterile), Individually-Wrapped	50	£42.32
E2996-1710	96-Well Microplate, Round Wells, Round Bottom, PS (Sterile), Individually-Wrapped	50	£42.32
E2996-1810	96-Well Microplate, Round Wells, Conical Bottom, PS (Sterile), Individually-Wrapped	50	£42.32
E2996-1910	PS Lid for 96-Well PS Microplates (Sterile), Ind. Wrapped	50	£33.39

<sup>1</sup>Aseptically produced in a fully-automated and bio-burden controlled environment.

Plate dimensions (WxDxH): 127.4 x 85.9 x 14.7mm.

# Polypropylene Assay Plates

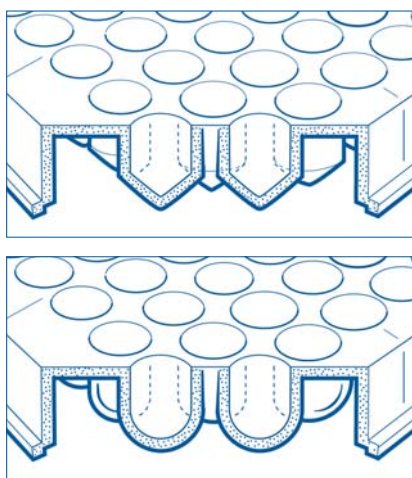

**Sealing options:** Polypropylene assay plates can be sealed with the sealing mats listed or with the plate seals on page 85. See also, the universal PP lid for all SBS plates on page 82

Polypropylene Assay Plates			
Cat. No.	Description	Pack Size	Price
<b>V-Shape Bottoms</b>			
E2996-1500	480µl Assay Plate, 96 Round Wells with V-Shape Bottoms	10	£17.85
E2996-1510	480µl Assay Plate, 96 Round Wells with V-Shape Bottoms (Sterile)	10	£22.26
<b>Round Bottoms</b>			
E2996-0500	500µl Assay Plate, 96 Round Wells with Round Bottoms	10	£17.85
E2996-0510	500µl Assay Plate, 96 Round Wells with Round Bottoms (Sterile)	10	£22.26
<b>Sealing Mats</b>			
E2896-1100	Piercable, Silicone Sealing Mat for 96 Deepwell Plates with Round Wells	10	£27.83
E2896-1110	Piercable, Silicone Sealing Mat for 96 Deepwell Plates with Round Wells (Sterile)	2 x 5	£33.39
E2896-2200	Chemically Resistant, Silicone Sealing Mat for 96 Deepwell Plates with Round Wells	10	£44.52

Plate dimensions (WxDxH): 127.76 x 85.48 x 14.35mm.

# Sealing Films & Foils

	Self-Adhesive Plate Seals							Heat-Sealing Plate Seals			
Description:	Aluminium StarSeal (PCR)*	Clear Polypropylene Seal (PCR)	Clear Polyolefin StarSeal (PCR)*	X-Clear Advanced Polyolefin StarSeal (qPCR)*	Polyester Seal	<i>New!</i> Polyethylene Seal	Breathable Film	Peelable Film (PCR)	Thermo Seal Film (PCR)	Easy Pierce Film (PCR)	Optically Clear Film (qPCR)
Ordering Info: (Non-sterile)	E2796-9792 £35.60 100 Seals	E2796-0793 £40.11 100 Seals	E2796-9793 £35.60 100 Seals	E2796-9795 £94.61 100 Seals	E2796-0794 £28.98 100 Seals	E2796-0796 £23.00 100 Seals	E2796-3005 £61.22 100 Seals	E2796-3060 £18.90 25 Seals	E2796-3070 £15.75 25 Seals	E2796-3090 £17.85 25 Seals	E2796-3020 £110.15 100 Seals
Ordering Info: (Sterile)	n/a	n/a	n/a	n/a	E2796-0714 £41.16 100 Seals	n/a	E2796-3015 £35.70 2 x 25 Seals	n/a	n/a	n/a	n/a
Colour	Silver	Clear	Clear	Clear	Clear	Clear	Natural	White	Silver	Silver	Clear
Self-adhesive	✓	✓	✓	✓	✓	✓	✓				
Heat seal								✓	✓	✓	✓
Opaque	✓						✓	✓	✓	✓	
Optically clear		✓	✓	✓	✓	✓					✓
Superior optical clarity				✓							✓
Suitable for PCR	✓	✓	✓	✓				✓	✓	✓	✓
Suitable for Real-Time PCR (qPCR)				✓							✓
Short-term storage and incubation	✓	✓	✓	✓	✓	✓	✓	✓	✓	✓	✓
Easy to pierce with needle or metal probe	✓	✓				✓			✓	✓	
Easy to pierce with pipette tip	✓	✓				✓			✓	✓	
Low 'tack to touch' adhesive**				✓							
Low auto-fluorescence			✓	✓							
Resistant to DMSO	✓	✓	✓	✓				✓	✓	✓	✓
Sterile option					✓		✓				
Breathable							✓				
Gas permeable							✓				
Certified	✓		✓	✓	✓		✓				
Plate type compatibility	PP, PS, PC	PP, PS, PC, PE	PP, PS, PC	PP, PS, PC	PP, PS	PS	PP, PS	PP, PE	PP	PP, PE	PP, PS, PE
Minimum temp. use	-70°C	-80°C	-70°C	-70°C	-40°C	-40°C	4°C	-200°C	-80°C	-80°C	-80°C
Maximum temp. use	110°C	120°C	110°C	110°C	65°C	40°C	40°C	90°C	120°C	80°C	120°C

\*StarSeals have a minimum temperature use specification of -70°C but they can be used at -80°C for short-term storage. n/a = not available.  
Key: PP = polypropylene. PS = polystyrene. PC = polycarbonate. PE = polyethylene.

### X-Clear Advanced Polyolefin StarSeal

E2796-9795 has a low tack-to-touch adhesive. This means that it does not feel sticky when handled, making it easier to handle so the seal sticks to your plate, not your gloves. The adhesive is pressure-sensitive, so it is only once you have correctly positioned the seal on the plate and you then apply pressure that the seal adheres to the plate. Once bonded, the seal strength is unbeatable

Contact STARLAB for a copy of the Data Sheet detailing the outstanding performance of E2796-9795 against a leading brand's seal



## Sealing Accessories



### Seal applicator

Polyethylene applicator for use with self-adhesive plate seals. Helps give a secure and smooth seal across the whole plate.

Seal Applicator			
Cat. No.	Description	Pack Size	Price
I2928-7355	Seal Applicator	5	£7.67



### Sealing brayer

Soft rubber roller for use with self-adhesive plate seals. Helps give a secure and smooth seal across the whole plate.

Seal Applicator			
Cat. No.	Description	Pack Size	Price
E9127-2940	Sealing Brayer	1	£21.84

## Parafilm® Sealing Film

### Colourless and moisture proof sealing film

A colourless and moisture proof film that moulds to the surface. Stretch film tight to seal beakers, flasks, tubes and petri dishes.

A dispenser made from chemically-resistant ABS is available, with a safety razor to cut the film without danger to fingers. Holds one or two 50mm wide rolls, or one 100m wide roll of film.



Parafilm & Dispenser			
Cat. No.	Description	Pack Size	Price
<b>Parafilm®</b>			
I3080-5075	Parafilm® (50mm Wide x 75m Long)	1 Roll	£24.47
I3080-1075	Parafilm® (100mm Wide x 75m Long)	1 Roll	£42.32
<b>Dispenser</b>			
I3080-0001	Parafilm® Dispenser, Blue	1	£28.98
I3080-0002	Parafilm® Dispenser, Green	1	£28.98
I3080-0004	Parafilm® Dispenser, Red	1	£28.98
I3080-0500	Replacement Blades for Parafilm® Dispenser	5	£3.57



# Autoclave Tape & Autoclave Bags

**New!**

25mm wide  
tape now  
available

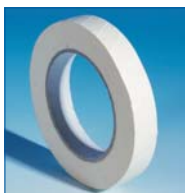

## Autoclave tape

Autoclave Tape			
Cat. No.	Description	Pack Size	Price
E3300-0000	Autoclave Tape (50m x 18mm)	4	£22.26
E3300-0001	Autoclave Tape (50m x 25mm)	4	£25.00



## Autoclave bags

- Polypropylene bags for autoclaving up to 136°C
- Printed with the 'biohazard' symbol
- Use for contaminated waste disposal
- White write-on panel

Autoclave Bags			
Cat. No.	Description	Pack Size	Price
E3300-3166	Autoclave Bag, 310 x 660mm	200	£35.60
E3300-4070	Autoclave Bag, 415 x 600mm	200	£38.96
E3300-6078	Autoclave Bag, 610 x 810mm	200	£72.35

# Cuvettes

Disposable cuvettes suitable for use with most open spectrophotometers. Provides optimum transmission level on the whole visible spectral. The material used avoids any possible measurement interference. High reliability is assured, with maximum absorption variation at: +/- 1%.

Light beam width: for 10mm. The two sides not crossed by the light beam are ribbed to an easy identification of the cuvette position inside the spectrophotometer measurement chamber, resulting in an easy positioning and removal.

## Standard cuvettes

- Polystyrene
- For assays in the visible spectral range 340 to 750nm (E1412-4160 range 340 to 900nm).

## UV grade cuvettes

- UV grade PMMA for accuracy throughout the UV/Vis range 280 to 800nm
- E1412-4451 is ideal for fluorometry and nephelometry

Cuvettes supplied in polystyrene rack with lid for safe storage.

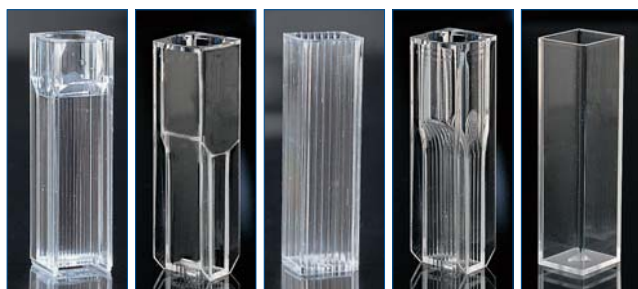

E1412-4150

E1412-4160

E1412-4450

E1412-4250

E1412-4451

Cuvettes			
Cat. No.	Description	Pack Size	Price
E1412-4150	1.5ml SemiMicro Cuvette, Square, Polystyrene	5 x 100	£49.04
E1412-4160	1.6ml Half Micro Cuvette, Transparent, Square, Polystyrene	5 x 100	£49.04
E1412-4450	4.5ml Macro Cuvette, Square, Polystyrene	5 x 100	£51.24
E1412-4250	2.5ml SemiMicro Cuvette, Square, UV Grade PMMA	5 x 100	£66.78
E1412-4451	4.5ml Macro Cuvette, Transparent, Square, UV Grade PMMA	5 x 100	£66.78

# Reagent Reservoirs

## Reusable Polypropylene Reservoir



### StarTub PP

Reusable, high quality reagent reservoirs made from white polypropylene (PP).

Autoclavable.

Dimensions (WxDxH):  
147 x 60 x 33mm

Cat. No.	Description	Volume	Pack Size	Price
S4026-5806	StarTub Reagent Reservoir (PP)	50–60ml	10	£13.34

## Disposable PVC Reservoir



### StarTub PVC

Disposable, clear PVC reservoirs for single use.

Dimensions (WxDxH):  
150 x 67 x 25mm

Cat. No.	Description	Volume	Pack Size	Price
E2310-1000	StarTub Reagent Reservoir (PVC)	55ml	100	£11.66

## Disposable PS Reservoirs



### StarTub PS

Disposable, white polystyrene reservoirs for single use. Available sterile, individually-wrapped (55ml) or bulk non-sterile (100ml).

Dimensions (WxDxH):  
55ml: 149 x 65 x 26mm  
100ml: 144 x 85 x 33mm

Cat. No.	Description	Volume	Pack Size	Price
E2310-1010	StarTub Reagent Reservoir (PS), (Sterile) Ind-Wrapped	55ml	50	£21.11
E2310-2000	StarTub Reagent Reservoir (PS)	100ml	100	£39.90

## CAPP Origami Reservoirs



### CAPP® Origami Reservoirs

Flat-packed durable polypropylene reservoirs ready for you to flick into shape. V-shaped bottom helps prevent bubbles forming and save on reagents.

Cat. No.	Description	Volume	Pack Size	Price
CA-40505	CAPP® Origami Reagent Reservoir	30ml	50	£22.05
CA-40510	CAPP® Origami Reagent Reservoir	40ml	50	£25.73

**New!**

## 3-Way Reusable Polypropylene Reservoir



### Three-Way Reservoir

Reusable multi-purpose white polypropylene reservoir that comprises:

- Graduated single reservoir (50ml)
- 8-channel reservoir (8 x 5ml)
- 12-channel reservoir (12 x 5ml)

Autoclavable.

Dimensions (WxDxH):  
111 x 112 x 28mm

Cat. No.	Description	Pack Size	Price
E2310-1812	3-Way Reusable Reagent Reservoir	10	£12.88

**New!**

## 12-Channel Reservoir



### 12-Channel Reservoir

Reusable, clear polypropylene reservoir with 12 x 22ml troughs.

Each trough is indexed with clear, black printed number.

Autoclavable.

Dimensions (WxDxH):  
128 x 87 x 44.5mm

Cat. No.	Description	Volume	Pack Size	Price
E2310-1200	12-Channel Reagent Reservoir	12 x 22ml	5	£17.00

## Cell Scrapers

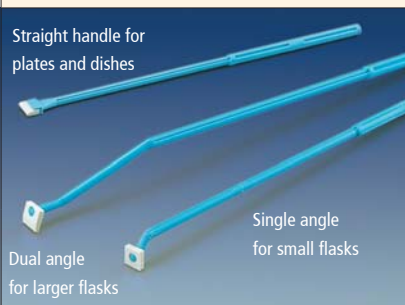
Cell Scrapers				
	Cat. No.	Description	Pack Size	Price
 <p>Straight handle for plates and dishes</p> <p>Dual angle for larger flasks</p> <p>Single angle for small flasks</p>	CC7600-0220	CytoOne® Cell Scraper, 220mm Long, 11mm Fixed Blade, Straight Handle, (Sterile), Ind. Wrapped	4 x 25	£116.87
	CC7600-0320	CytoOne® Cell Scraper, 320mm Long, 12mm Pivoting Blade, Dual Angle Handle, (Sterile), Ind. Wrapped	4 x 25	£116.87
	CC7600-0250	CytoOne® Cell Scraper, 250mm Long, 10mm Pivoting Blade, Single Angle Handle, (Sterile), Ind. Wrapped	4 x 25	£116.87

## Loops

**FREE SAMPLE**  
**TRY**  
before you  
**BUY**  
available on request

Loops				
	Cat. No.	Description	Pack Size	Price
	E1412-0111	1µl Calibrated Loop, Soft Type (Sterile), Green	50 x 20	£40.11
	E1412-0112	1µl Calibrated Loop, Rigid Type (Sterile), Blue	50 x 20	£28.98
	E1412-5012	5µl Calibrated Loop, Rigid Type (Sterile), Blue	50 x 20	£21.21
	E1412-1011	10µl Calibrated Loop, Soft Type (Sterile), Sky Blue	50 x 20	£40.11
	E1412-1012	10µl Calibrated Loop, Rigid Type (Sterile), Blue	50 x 20	£28.98

NOTE: Not recommended for colony counting

## Spreaders

Spreaders				
	Cat. No.	Description	Pack Size	Price
	E1412-1001	L-Shaped Spreader, PS (Sterile), Individually Wrapped, White	500	£53.45
	E1412-1005	L-Shaped Spreader, PS (Sterile), White (Supplied in peel-packs of 5 spreaders)	100 x 5	£47.88
	E1410-1025	L-Shaped Spreader, PP (Sterile), Blue (Supplied in peel-packs of 25 spreaders)	40 x 25	£44.52

# Pasteur Pipettes

## STANDARD, GRADUATED PIPETTES

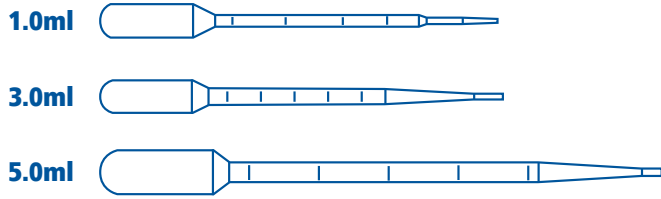

## EXTRA LONG PIPETTES

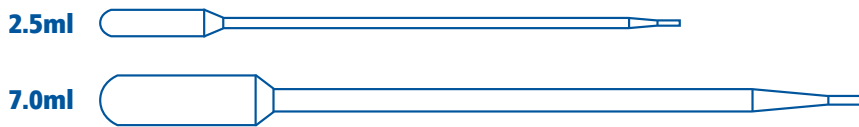

## FINE TIP PIPETTES

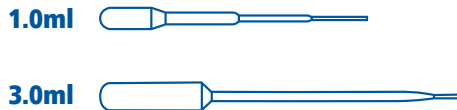

## Polyethylene pipettes

A range of polyethylene pipettes which are manufactured to ISO standards and are CE marked for IVD.

### Features

- Sterile or non-sterile
- Low affinity surface
- Attached bulb avoids cross-contamination
- One-step biohazard disposal
- Shatter-proof low-density polyethylene, which is non-toxic and inert
- Can be frozen in liquid nitrogen
- Sterile pipettes are supplied in peel-back packs printed with the Lot No. and expiration date

Pasteur Pipettes							
Cat. No.	Description	Graduations	Length	Bulb Draw	Stem Diam.	Pack Size	Price
<b>Standard Pipettes</b>							
E1414-0100	1.0ml Graduated Pasteur Pipette	0.25ml	154mm	3.1ml	5.0mm	500	£9.98
E1414-0110	1.0ml Graduated Pasteur Pipette (Sterile)					25 x 20	£21.11
E1414-0111	1.0ml Graduated Pasteur Pipette (Sterile), Ind. Wrapped					500	£32.24
E1414-0300	3.0ml Graduated Pasteur Pipette	0.5ml	154mm	3.2ml	7.8mm	500	£9.98
E1414-0310	3.0ml Graduated Pasteur Pipette (Sterile)					25 x 20	£21.11
E1414-0311	3.0ml Graduated Pasteur Pipette (Sterile), Ind. Wrapped					500	£32.24
E1414-0500	5.0ml Graduated Pasteur Pipette	1.0ml	216mm	3.5ml	8.0mm	250	£17.85
<b>XL Pipettes</b>							
E1414-2500	2.5ml XL Pasteur Pipette	n/a	225mm	2.3ml	5.0mm	400	£25.62
E1414-0700	7.0ml XL Pasteur Pipette	n/a	300mm	7.1ml	9.0mm	100	£30.03
<b>Fine Tip Pipettes</b>							
E1414-1100	1.0ml Micro Fine Tip Pasteur Pipette	n/a	104mm	1.0ml	3.0mm	400	£43.37
E1414-1300	3.0ml Fine Tip Pasteur Pipette	n/a	144mm	3.3ml	5.0mm	500	£33.39
E1414-1310	3.0ml Fine Tip Pasteur Pipette (Sterile)					25 x 20	£36.75
E1414-1311	3.0ml Fine Tip Pasteur Pipette (Sterile), Ind. Wrapped					500	£89.04

NOTE: Volumetric tolerance of all pipettes is  $\pm 10\%$ .

# Pasteur Pipettes

## GRADUATED PIPETTES

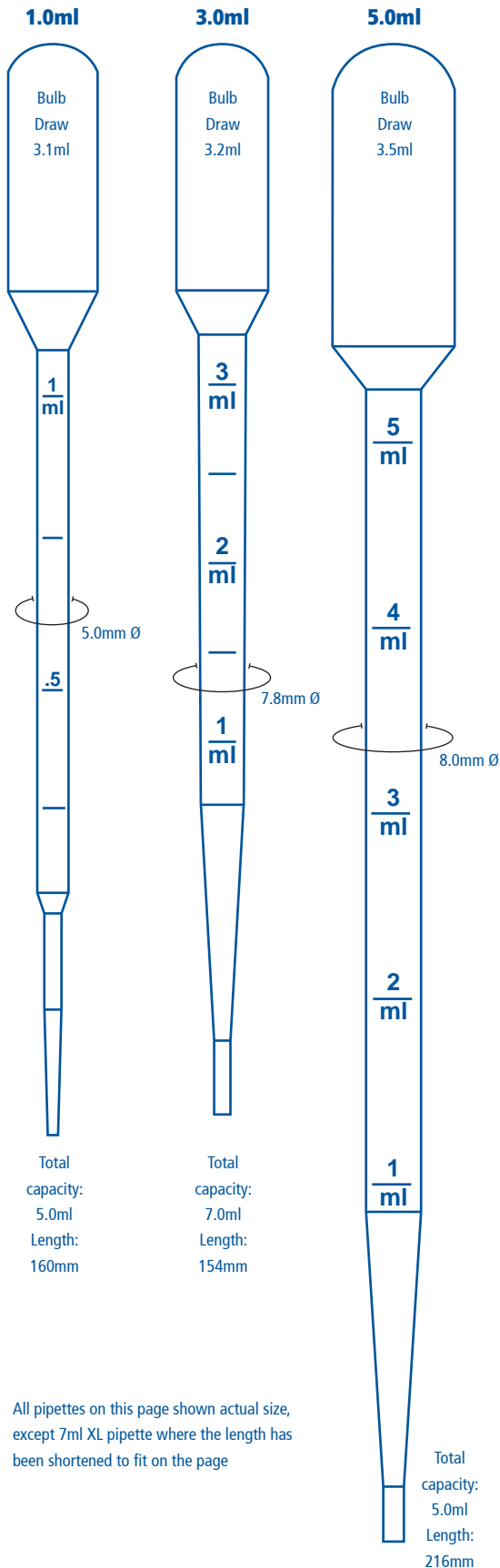

## XL PIPETTES

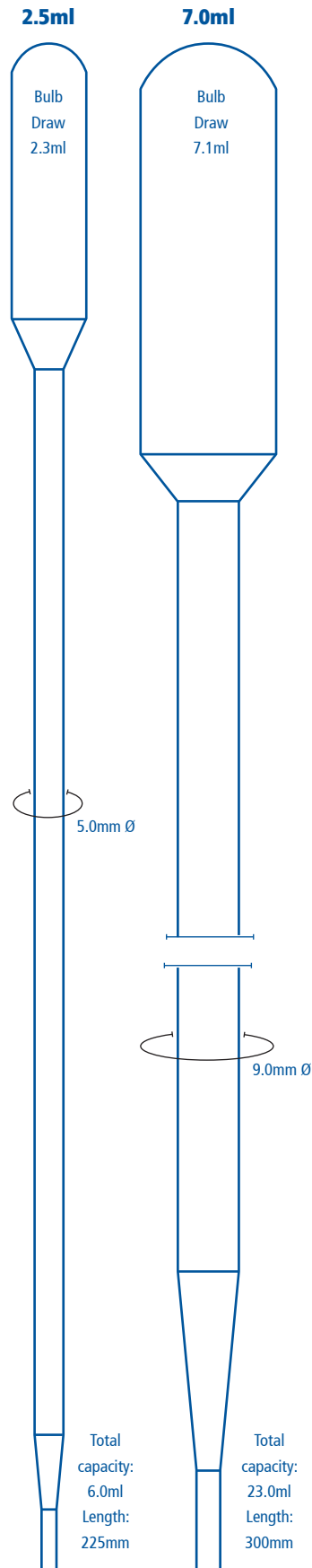

## FINE TIP

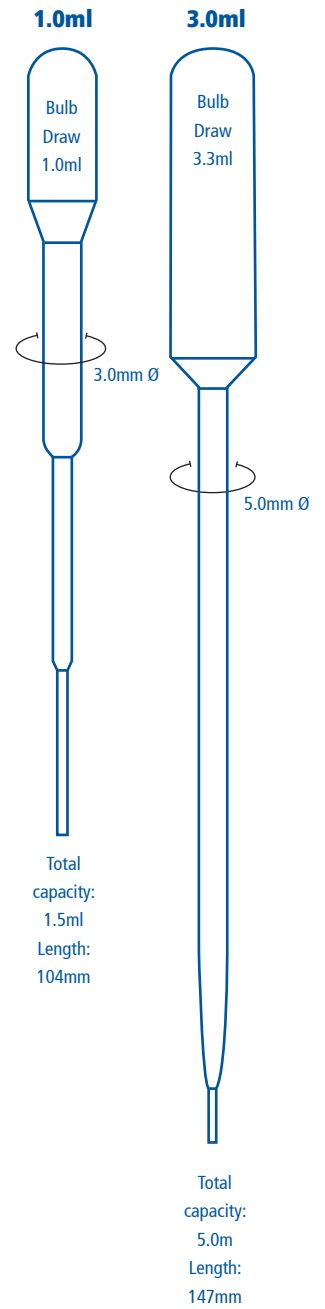

All pipettes on this page shown actual size, except 7ml XL pipette where the length has been shortened to fit on the page

## Spatulas & Weighboats

**New!**



Spatulas feature a scoop end and a spatula end

Why risk possible cross-contamination with conventional spatulas! These single-use, polypropylene spatulas increase efficiency and reduce the risk of costly, accidental cross-contamination. Autoclavable.



**New! Anti-static weigh boats**



Disposable Spatulas			
Cat. No.	Description	Pack Size	Price
E1412-7200	140mm SmartSpatula®, Anti-Static	300	£19.84
E1412-7201	140mm EcoSpatula®	300	£30.64
E1412-7202	210 SmartSpatula®, Blue	300	£28.00
E1412-7203	210mm SmartSpatula®	300	£28.00
E1412-7204	210mm SmartSpatula® (Sterile)	100	£116.69
E1412-7205	310mm SmartSpatula®, Green	150	£26.84

EcoSpatula® is made with EcoPure additive which helps promote biodegradation.

- Manufactured from high impact polystyrene
- Non wettable with smooth surface and rounded corners
- Wide rim boats, all with flat bottoms
- Anti-static treatment minimises powder hang-up

Weigh Boats			
Cat. No.	Description	Pack Size	Price
E3300-0050	5ml Diamond Weigh Boat (40 x 60mm)	4 x 250	£19.00
E3300-0070	7ml Square Weigh Boat (44 x 44mm)	4 x 250	£19.00
E3300-0030	30ml Diamond Weigh Boat (65 x 87mm)	2 x 250	£20.00
E3300-0010	100ml Square Weigh Boat (80 x 80mm)	4 x 250	£39.00
E3300-0011	100ml Diamond Weigh Boat (126 x 100mm)	250	£21.00
E3300-0025	250ml Square Weigh Boat (138 x 138mm)	4 x 250	£75.00

## Cryogenic Labels

**New!**

E9189-0099



StarTags CRYO

38 x 15mm

9,5mm  
Ø

Pre-cut labels for ultra-low temperatures.

- Temperature use: -196°C to 100°C
- For use on polypropylene, glass, and polycarbonate
- Brightly coloured spots mean you can identify your samples whilst they are still in the box!

Cryogenic Labels			
Cat. No.	Description	Pack Size	Price
<b>Spots</b>			
E9189-0099	9.5mm diam. Cryogenic Spots, Mixed	5000/Roll	£32.50
<b>Labels (38 x 15mm)</b>			
E9189-3009	StarTag Cryo (38 x 15mm), White	1000/Roll	£21.11

NOTE: Labels must be applied to dry, unfrozen samples at room temperature.

# Laboratory Labels

## StarTags: One label you'll want to stick with!

Pre-cut labels that will accept any form of marker pen and will stick permanently in most conditions. StarTags are suitable for use in the freezer, centrifuge, waterbath, thermal cycler, shaker or vortexer. Laser sheets are available in some options, allowing you print out large numbers of labels which is both time saving and convenient.



### Features

- Suitable for autoclaving, boiling and freezing down to -85 °C
- Sticks permanently to all forms of tubes, plates, vials and bottles
- No sticky residue left following removal

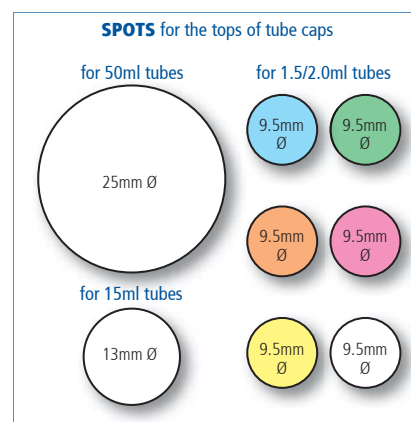

Labels shown actual size

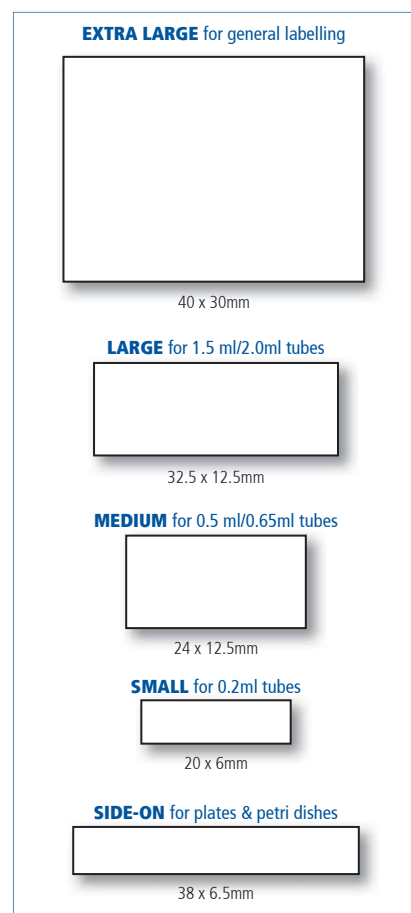

StarTags Laboratory Labels					
Cat. No.	Description	Colour	Pack Type	Labels per Pack	Price
<b>Spots</b>					
E9185-0509	25mm diam. Spots	White	Roll	1000	£14.49
E9185-0159	13mm diam. Spots	White	Roll	1500	£14.49
E9185-0001	9.5mm diam. Spots	Blue	Roll	2000	£14.49
E9185-0002	9.5mm diam. Spots	Green	Roll	2000	£14.49
E9185-0003	9.5mm diam. Spots	Orange	Roll	2000	£14.49
E9185-0004	9.5mm diam. Spots	Red	Roll	2000	£14.49
E9185-0006	9.5mm diam. Spots	Yellow	Roll	2000	£14.49
E9185-0009	9.5mm diam. Spots	White	Roll	2000	£14.49
<b>Labels</b>					
E9189-1009	Extra Large (30 x 40mm)	White	Roll	500	£17.85
E9189-2009	Extra Large (30 x 40mm)	White	A4 Laser Sheets	800	£33.39
E9187-1009	Large (32.5 x 12.5mm)	White	Roll	1000	£14.49
E9187-2016	Large (32.5 x 12.5mm)	White	A4 Laser Sheets	1980	£33.39
E9188-1009	Medium (24 x 12.5mm)	White	Roll	1000	£14.49
E9185-2240	Medium (24 x 12.5mm)	White	A4 Laser Sheets	2016	£33.39
E9188-8699	Small (20 x 6.0mm)	White	Roll	1000	£14.49
E9188-7925	Side-On (38 x 6.5mm)	White	Roll	1000	£14.49

**A4 Laser Sheets** are supplied with set-up instructions for MS Word. Sheets are only suitable for use with laser printers and can not be used with bubble jet printers.



Blue acrylic dispenser that holds up to seven boxes of StarTags. Rubber feet on base prevents slipping.

StarTags Dispenser		
Cat. No.	Description	Price
E9199-0000	StarTags Acrylic Dispenser	£50.09

Fine Point Pen		
Cat. No.	Description	Price
E9186-9987	Fine Point Pen for use with all StarTags	£2.21

Labelling



# Laboratory ID Tape



## Dispense with disorganisation!

Organise and identify your samples more easily by colour-coding with STARLAB ID Tape. There's plenty to choose from with two different lengths of tape in three different widths, and all in eight different colours.

## Dispenser features

- Custom-made acrylic dispenser which holds both lengths of tape
- Suction feet ensures the dispenser stays firmly on the bench, even when using one hand to dispense the tape
- Core inserts for 55m long tape available separately

ID Tape Dispenser		
Cat. No.	Description	Price
E9026-0000	ID Tape Dispenser (Pack comprises 1 Dispenser & 5 Core Inserts)	£50.09
E9026-2005	Core Inserts, Pack of 5 (To hold the 55m long ID Tapes in the Dispenser)	£8.93

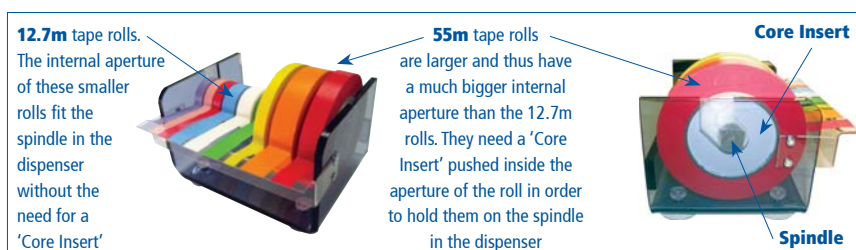

## ID Tape features

- Suitable for use in the freezer, the fridge, the incubator and in the autoclave (-20°C to 121°C)
- Use on glass, plastic, metal, paper, rubber and any other dry surface
- Oil, water and acid resistant
- Paper-based tape that can be written on with pen, pencil or Lab Marker
- Leaves no adhesive residue when removed
- Available in individual rolls or in mixed, multi-packs of eight

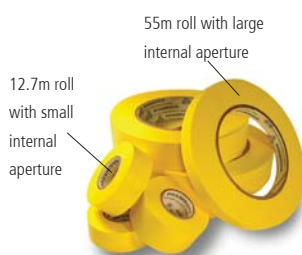

		Individual Rolls								8-Pack
Tape Length	Tape Width	Blue	Green	Orange	Red	Violet	Yellow	Pink	White	Mixed
12.7m	12.7mm	E9127-1271 £3.36	E9127-1272 £3.36	E9127-1273 £3.36	E9127-1274 £3.36	E9127-1275 £3.36	E9127-1276 £3.36	E9127-1270 £3.36	E9127-1279 £3.36	E9127-1278 £25.41
	19.0mm	E9127-1911 £4.62	E9127-1912 £4.62	E9127-1913 £4.62	E9127-1914 £4.62	E9127-1915 £4.62	E9127-1916 £4.62	E9127-1910 £4.62	E9127-1919 £4.62	E9127-1918 £34.55
	25.4mm	E9127-2501 £5.88	E9127-2502 £5.88	E9127-2503 £5.88	E9127-2504 £5.88	E9127-2505 £5.88	E9127-2506 £5.88	E9127-2500 £5.88	E9127-2509 £5.88	E9127-2508 £45.68
55m*	12.7mm	E9055-1271 £8.72	E9055-1272 £8.72	E9055-1273 £8.72	E9055-1274 £8.72	E9055-1275 £8.72	E9055-1276 £8.72	E9055-1270 £8.72	E9055-1279 £8.72	E9055-1278 £66.78
	19.0mm	E9055-1911 £12.29	E9055-1912 £12.29	E9055-1913 £12.29	E9055-1914 £12.29	E9055-1915 £12.29	E9055-1916 £12.29	E9055-1910 £12.29	E9055-1919 £12.29	E9055-1918 £91.25
	25.4mm	E9055-2501 £14.39	E9055-2502 £14.39	E9055-2503 £14.39	E9055-2504 £14.39	E9055-2505 £14.39	E9055-2506 £14.39	E9055-2500 £14.39	E9055-2509 £14.39	E9055-2508 £110.57

\*55m long tape requires a core insert for use in the STARLAB dispenser

Mixed packs contain one roll of each colour.



# BMP™ 21 Label Printer & Label Cartridges

## Faster labelling!

Simple to operate and quick to print, the BMP™21 label printer is an economical, must-have labelling tool. With this thermal transfer printer you can create your labels just once – knowing they'll stay stuck and stay legible.



### Features

- Smudge-resistant thermal transfer printing
- Barcoding (3 of 9, 128)
- Automated data serialisation (including multiple copy and increment options) and built in graphics
- Font options: six sizes (6, 9, 14, 20, 28 & 40pt) plus auto sizing, and bold
- Ergonomic cutter on both sides which holds the label until you need it
- Internal memory for storing, retrieving and deleting label files
- Quick and easy cartridge loading
- Six languages
- Backlit LCD display
- Automatic shut-off saves batteries

### Printer Specifications

Print Method	Thermal Transfer (Durable. Non-Smearing)
Display	LCD
Max. Labels per day	75
Max. Label Width	19mm
Max. Print Width	16mm
Print resolution (dpi)	203
Barcoding	Yes. 1D (Linear)
Keyboard	ABC
Memory	Stores 12 files
Power Source	6 x AA Batteries (not incl.) or AC (optional adaptor)
Agency Approval	Printer: FCC Class B Approved Labels: UL and CSA Approved
Weight	0.75kg
Dimensions	114 x 64 x 228mm

### BMP™21 Label Printer

Cat. No.	Description	Price
N3000-2000	Brady® BMP™21 Label Printer	£126.00
N3000-2001	AC Adaptor (optional)	£38.33

The printer is supplied with a 19.1mm B-499 Nylon label cartridge (N7519-4999) ready installed. BMP21 is designed for portability and runs on 6 x AA batteries (not included). Mains electricity can also be used with the optional AC Adaptor available separately.



Easy to load cartridge.  
Just drop, lock and go!



### BMP™21 Label Cartridges

Cat. No.	Description	Colour	Label Width	Price
N3795-4391	B-439 Vinyl	Blue	9.5mm	£17.85
N3795-4392	B-439 Vinyl	Green	9.5mm	£17.85
N3795-4393	B-439 Vinyl	Orange	9.5mm	£17.85
N3795-4394	B-439 Vinyl	Red	9.5mm	£17.85
N3795-4396	B-439 Vinyl	Yellow	9.5mm	£17.85
N3795-4399	B-439 Vinyl	White	9.5mm	£17.85
N3795-4619	B-461 Polyester <sup>1</sup>	White	9.5mm	£24.47
N5127-4619	B-461 Polyester <sup>1</sup>	White	12.7mm	£21.11
N7519-4889	B-488 Polyester	White	19.1mm	£23.42
N7519-4999	B-499 Nylon <sup>1</sup>	White	19.1mm	£24.99

<sup>1</sup> B-461 is acceptable for use in liquid nitrogen only if the ends of the label overlap. See page 96 for label material specifications. All labels 6.4m long, except N7519-4999 which is 4.8m long.

### Label Applications

Freezer (-80°C)	Liquid Nitrogen (-196°C)	Autoclave (121°C)	Hot Water Baths (100°C)	Low-Profile (extremely thin)	Vial Labelling	Slide Labelling	Plate Labelling	General Labelling
✓							✓	✓
✓							✓	✓
✓							✓	✓
✓							✓	✓
✓							✓	✓
✓	✓	✓	✓	✓	✓		✓	✓
✓	✓	✓	✓	✓	✓		✓	✓
✓		✓				✓	✓	✓
✓	✓	✓				✓	✓	✓

# LabPal™ & LabXpert™ Label Cartridges

## Label cartridges for LabPal™ printer

LabPal™ Label Cartridges					Label Applications								
Cat. No.	Description	Colour	Label Width	Price	Freezer (-80°C)	Liquid Nitrogen (-196°C)	Autoclave (121°C)	Hot Water Baths (100°C)	Low-Profile (extremely thin)	Vial Labelling	Slide Labelling	Plate Labelling	General Labelling
N3795-4391	B-439 Vinyl	Blue	9.5mm	£17.85	✓							✓	✓
N3795-4392	B-439 Vinyl	Green	9.5mm	£17.85	✓							✓	✓
N3795-4393	B-439 Vinyl	Orange	9.5mm	£17.85	✓							✓	✓
N3795-4394	B-439 Vinyl	Red	9.5mm	£17.85	✓							✓	✓
N3795-4396	B-439 Vinyl	Yellow	9.5mm	£17.85	✓							✓	✓
N3795-4399	B-439 Vinyl	White	9.5mm	£17.85	✓							✓	✓
N3795-4619	B-461 Polyester <sup>1</sup>	White	9.5mm	£24.47	✓	✓	✓	✓	✓	✓		✓	✓
N5127-4619	B-461 Polyester <sup>1</sup>	White	12.7mm	£21.11	✓	✓	✓	✓	✓	✓		✓	✓
N7519-4889	B-488 Polyester	White	19.1mm	£23.42	✓		✓				✓	✓	✓

<sup>1</sup> B-461 is acceptable for use in liquid nitrogen only if the ends of the label overlap.  
All labels are 6.4m long.

## Label cartridges for LabXpert™ printer

LabXpert™ Label Cartridges									
Label Style	Cat. No.	Label Material	Label Type	Colour	Labels per Cartridge	Label Dimensions (mm)			Price
						A	B	C	
1	N0108-4619	B-461 Polyester <sup>1</sup>	Long Tail	White	500	4.75	38.10	17.78	£34.76
1	N0072-4619	B-461 Polyester <sup>1</sup>	Long Tail	White	225	12.70	44.45	19.05	£44.73
1	N0074-4619	B-461 Polyester <sup>1</sup>	Long Tail	White	175	12.70	55.88	19.05	£38.64
1	N0086-4619	B-461 Polyester <sup>1</sup>	Long Tail	White	150	15.24	66.68	25.40	£38.64
2	N0118-4999	B-499 Nylon	Free Standing	White	350	25.40	9.53	9.53	£38.22
2	N0117-4999	B-499 Nylon	Free Standing	White	300	25.40	12.70	11.18	£45.99
3	N0082-4999	B-499 Nylon	Free Standing	White	300	9.53			£30.66
3	N0082-4993	B-499 Nylon	Free Standing	Orange	300	9.53			£37.70
3	N0082-4996	B-499 Nylon	Free Standing	Yellow	300	9.53			£37.70
4	N0119-4619	B-461 Polyester <sup>1</sup>	Long/Short Tail	White	100	38.10	95.25	31.75	£35.39
4	N0081-4889	B-461 Polyester <sup>1</sup>	Free Standing	White	200	48.26	6.35		£33.08
5	N0097-4889	B-461 Polyester <sup>1</sup>	Free Standing	White	400	22.86	22.86		£56.28

B-461: Label must overlap for use in liquid nitrogen.

<sup>1</sup> Long Tail for 15ml Tubes / Short Tail for 50ml Tubes

LABEL STYLE 1

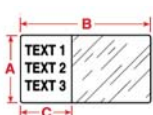

LABEL STYLE 2

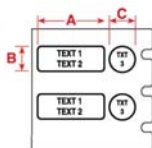

LABEL STYLE 3



LABEL STYLE 4

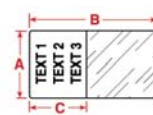

LABEL STYLE 5

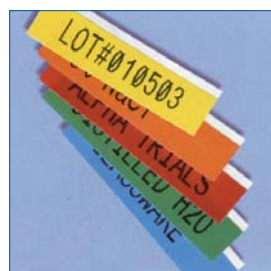
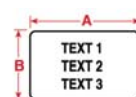

Coloured labels (B-439) for general labelling

For Use With							
0.2ml Tubes	0.5 / 0.65ml Tubes	1.5/2.0ml Tubes	1-8ml Tubes	15ml Tubes	50ml Tubes	Plates	Slides
✓							
	✓						
		✓	✓				
		✓	✓				
		✓					
		✓					
				✓	✓		
						✓	
							✓

### Label Material Specifications

B-461 Polyester	Very low profile to prevent vials jamming in centrifuge or racks. Good solvent resistance. Stays put in the harshest conditions. Uses: • Liquid nitrogen (-196°C). • Freezer (-80°C). • Hot water bath (100°C). • Autoclave (121°C).
B-499 Nylon	Ideal for general purpose labelling, the permanent adhesive and thicker construction makes this material durable yet easy to handle. Uses: • Liquid nitrogen (-196°C) (not on glass). • Freezer (-80°C). • Autoclave (121°C).
B-488 Polyester	With permanent adhesion, outstanding chemical resistance and write-on capabilities, this material performs in the very harshest lab environments. Uses: • Freezer (-80°C). • Autoclave (121°C).



# Sample Storage

## STORAGE BOXES AND RACKS

Cardboard Storage Boxes .....	98-99
Polypropylene Storage Boxes .....	100-102
Cryogenic Storage Boxes & Racks.....	103-104
Storage Racks .....	105-106
Multi-Tube Racks .....	107-109
PCR Sample Racks.....	109-110

## BENCHTOP COOLERS

Chiller Racks.....	111
Cooler Containers.....	111
Transport Cases & Coolers.....	112
Ice Bath / Floating Rack .....	112

<b>STAINLESS STEEL STORAGE</b> .....	113
--------------------------------------	-----

## FREEZER RACKING

Freezer Racking for Upright Freezers .....	114-117
Freezer Racking for Chest Freezers.....	118-119
Custom Made Freezer Racking .....	119

## SLIDE STORAGE & STAINING

Slide Storage Cabinets .....	120
Slide Storage Trays .....	120-121
Slide Storage Boxes .....	121
Slide Staining.....	122
Slide Mailers .....	122

## Cardboard Storage Boxes

Cardboard storage boxes with a standard 133 x 133mm footprint, available in four heights. Moisture-resistant coating makes the boxes a durable yet economical storage solution. Now available in a range of colours to help with colour-coding your samples. For use down to -80°C.



### New! 32mm high boxes

32mm High Cardboard Storage Boxes (133x133) with Dividers				
Description	Box Colour	Cat. No.*	Pack Size	Price
<b>196-place</b> white cardboard storage box with removable 14x14 dividers for tubes up to 8mm diameter, eg. 0.5ml PCR or microcentrifuge tubes.	White	A9632-1969	6	£18.00
	Blue, Green, Red or Yellow*	A9632-196#	6	£19.50
<b>256-place</b> white cardboard storage box with removable 16x16 dividers for tubes up to 7mm diameter, eg. 0.2ml PCR tubes.	White	A9632-2569	6	£18.00
	Blue, Green, Red or Yellow*	A9632-256#	6	£19.50

\*To order box colour required, replace last digit of Cat. No. with: 1 for Blue, 2 for Green, 4 for Red, 6 for Yellow. Dimensions (WxDxH): 133 x 133mm x 35mm (with lid). Max tube diam. stated includes tube's cap.

### New! Coloured boxes

50mm High Cardboard Storage Boxes (133x133) with Dividers				
Description	Box Colour	Cat. No.*	Pack Size	Price
<b>16-place</b> cardboard storage boxes with removable 4x4 dividers for tubes up to 31mm diameter.	White	A9623-1616	6	£18.90
	Blue, Green, Red or Yellow*	A9623-160#	6	£20.00
<b>25-place</b> cardboard storage boxes with removable 5x5 dividers for tubes up to 24.5mm diameter, eg. 7.0ml bijou containers.	White	A9623-2525	6	£18.90
	Blue, Green, Red or Yellow*	A9623-250#	6	£20.00
<b>49-place</b> cardboard storage boxes with removable 7x7 dividers for tubes up to 16.5mm diameter, eg. 1.2/2.0ml cryogenic vials.	White	A9623-4949	6	£18.90
	Blue, Green, Red or Yellow*	A9623-490#	6	£20.00
<b>81-place</b> white cardboard storage box with removable 9x9 dividers for tubes up to 13mm diameter, eg. 1.5/2.0ml microcentrifuge tubes, screw cap microtubes, 1.2/2.0ml cryogenic vials with internal thread.	White	A9623-8181	6	£18.90
	Blue, Green, Red or Yellow*	A9623-810#	6	£20.00
<b>100-place</b> white cardboard storage box with removable 10x10 dividers for tubes up to 12mm diameter, eg. screw cap microtubes.	White	A9623-3100	6	£18.90
	Blue, Green, Red or Yellow*	A9623-310#	6	£20.00

\*To order box colour required, replace last digit of Cat. No. with: 1 for Blue, 2 for Green, 4 for Red, 6 for Yellow. Dimensions (WxDxH): 133 x 133mm x 53mm (with lid). Max. tube diam. stated includes tube's cap.

**Boxes and dividers can also be purchased separately. See our website for ordering details.**

50mm high boxes can be used in the freezer racking used in pages 114–115 and 118



# Cardboard Storage Boxes

**New!** Coloured boxes

75mm High Cardboard Storage Boxes (133x133) with Dividers				
Description	Box Colour	Cat. No.	Pack Size	Price
<b>16-place</b> cardboard storage boxes with removable 4x4 dividers for tubes up to 31mm diameter.	White	A9625-1616	6	£24.47
	Blue, Green, Red or Yellow*	A9625-160#	6	£25.50
<b>25-place</b> cardboard storage boxes with removable 5x5 dividers for tubes up to 24.5mm diameter.	White	A9625-2525	6	£24.47
	Blue, Green, Red or Yellow*	A9625-250#	6	£25.50
<b>49-place</b> cardboard storage boxes with removable 7x7 dividers for tubes up to 16.5mm diameter, eg. 3.0/4.0ml cryogenic vials and 12x75 tubes.	White	A9625-4949	6	£24.47
	Blue, Green, Red or Yellow*	A9625-490#	6	£25.50
<b>81-place</b> white cardboard storage box with removable 9x9 dividers for tubes up to 13mm diameter, eg. 3.0/4.0ml cryogenic vials with internal thread and 12x75 tubes.	White	A9625-8181	6	£24.47
	Blue, Green, Red or Yellow*	A9625-810#	6	£25.50
<b>100-place</b> white cardboard storage box with removable 10x10 dividers for tubes up to 12mm diameter.	White	A9625-3100	6	£24.47
	Blue, Green, Red or Yellow*	A9625-310#	6	£25.50

\*To order box colour required, replace last digit of Cat. No. with: 1 for Blue, 2 for Green, 4 for Red, 6 for Yellow.  
Dimensions (WxDxH): 133 x 133mm x 78mm (with lid). Max tube diam. stated includes tube's cap.

**New!** Coloured boxes

100mm High Cardboard Storage Boxes (133x133) with Dividers				
Description	Box Colour	Cat. No.	Pack Size	Price
<b>16-place</b> cardboard storage boxes with removable 4x4 dividers for tubes up to 31mm diameter, eg 30ml universal containers.	White	A9627-1616	6	£32.24
	Blue, Green, Red or Yellow*	A9627-160#	6	£34.50
<b>25-place</b> cardboard storage boxes with removable 5x5 dividers for tubes up to 24.5mm diameter, eg. 12ml skirted tubes and culture tubes.	White	A9627-2525	6	£32.24
	Blue, Green, Red or Yellow*	A9627-250#	6	£34.50
<b>49-place</b> cardboard storage boxes with removable 7x7 dividers for tubes up to 16.5mm diameter, eg. 5.0ml cryogenic vials.	White	A9627-4949	6	£32.24
	Blue, Green, Red or Yellow*	A9627-490#	6	£34.50
<b>81-place</b> white cardboard storage box with removable 9x9 dividers for tubes up to 13mm diameter, eg. 5ml cryogenic vials with internal thread.	White	A9627-8181	6	£32.24
	Blue, Green, Red or Yellow*	A9627-810#	6	£34.50
<b>100-place</b> white cardboard storage box with removable 10x10 dividers for tubes up to 12mm diameter.	White	A9627-3100	6	£32.24
	Blue, Green, Red or Yellow*	A9627-310#	6	£34.50

\*To order box colour required, replace last digit of Cat. No. with: 1 for Blue, 2 for Green, 4 for Red, 6 for Yellow.  
Dimensions (WxDxH): 133 x 133mm x 103mm (with lid). Max. tube diam. stated includes tube's cap.

**New!** Larger footprint boxes

## 50mm high cardboard storage boxes (136x136) with dividers

The slightly larger footprint of these boxes gives more space for the lids of micro-centrifuge tubes, thus allowing the full 100 tubes to fit in the box. Boxes are 50mm high and have 10x10 removable dividers for tubes up to 12.25mm diameter.



Box Colour	Cat. No.*	Pack Size	Price
White	A9650-1369	1	£19.00
Blue, Green, Red or Yellow*	A9650-136#	1	£21.00

\*To order box colour required, replace last digit of Cat. No. with: 1 for Blue, 2 for Green, 4 for Red, 6 for Yellow.

Dimensions (WxDxH): 136 x 136mm x 53mm (with lid).

Max. tube diam. stated includes tube's cap.

## Cardboard storage boxes for 15ml & 50ml centrifuge tubes

36-place for 15ml tubes or 16-place for 50ml tubes. Manilla cardboard box with lift-off lid. Removable dividers. Moisture resistant coating. Max. tube height: 140mm.







Box Type	Cat. No.	Pack Size	Price
36-Place for 15ml Tubes	I9023-1615	1	£7.14
16-Place for 50ml Tubes	I9023-1650	1	£7.14

Dimensions (WxDxH): 145 x 145 x 80mm (with lid).

# Polypropylene Storage Boxes

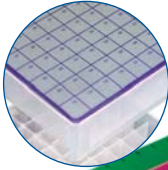
## The StarStore 130 x 130mm range for freezer storage

The range of StarStore storage boxes below all have the same, standard 130mm x 130mm footprint. The non-hinged, lift-off lids enable tubes of varying heights to be stored inside. All boxes are made from rigid polypropylene and are suitable for use in temperatures -90°C to 121°C. Autoclavable.

130 x 130mm Range of Storage Boxes					
	Description	Colour	Cat. No.	Pack Size	Price
 <p>StarStore 81 can also be used with the optional acetate grid that sits under the lid</p> 	<p><b>StarStore 81</b> polypropylene storage box.</p> <p>81 fixed 13mm x 13mm dividers. Use with 1.5/2.0ml microcentrifuge tubes or screw cap microtubes.</p> <p>Transparent lift-off lid with frosted writing panel on side. Vent holes in base to aid draining and lid removal.</p> <p>Printed reference grid on base, or use the optional acetate grid that sits under the lid.</p> <p>Dimensions (WxDxH): 130 x 130 x 45mm.</p> <p>Max. tube height: 60mm.</p>	Natural	I 2381-5040	5	£28.98
		Black	I 2381-5049	5	£31.71
		Neon Blue	I 2381-5041	5	£31.71
		Neon Green	I 2381-5042	5	£31.71
		Neon Orange	I 2381-5043	5	£31.71
		Neon Pink	I 2381-5044	5	£31.71
		Neon Yellow	I 2381-5046	5	£31.71
		Neon Mixed*	I 2381-5048	5	£31.71
		<b>81-place acetate grid</b> for use with StarStore 81.	n/a	I 2381-1025	25
	<p><b>StarStore 49</b> polypropylene storage box.</p> <p>Fixed 16mm x 16mm dividers for the storage of 49 tubes up to 16mm diam.</p> <p>Transparent lift-off lid with frosted writing panel on side. Vent holes in base to aid draining and lid removal.</p> <p>Optional, removable acetate grid that sits under the lid.</p> <p>Dimensions (WxDxH): 130 x 130 x 46mm.</p> <p>Max. tube height: 60mm.</p>	Natural	E2349-5009	5	£33.39
		<b>49-place acetate grid</b> for use with StarStore 49.	n/a	I2349-1025	25
	<p><b>StarStore</b> polypropylene storage box.</p> <p>No dividers to enable the storage of various tube shapes and sizes.</p> <p>Transparent lift-off lid.</p> <p>Vent holes in base to aid draining and lid removal.</p> <p>Dimensions (WxDxH): 130 x 130 x 45mm.</p>	Natural	E2300-5005	5	£33.39

\* Mixed pack contains one of each neon colour.

The 130 x 130mm storage boxes above can be used in the freezer racking on pages 114–115 and 118





Long, polypropylene storage box. Temperature use: -90°C to 121°C. Autoclavable.

100-Place Long Storage Boxes					
	Description	Colour	Cat. No.	Pack Size	Price
<p><b>New!</b></p> 	<p><b>100-place long</b> polypropylene storage box.</p> <p>Fixed 13mm x 13mm dividers. Holds 1.5/2.0ml microcentrifuge tubes or screw cap microtubes.</p> <p>Lift-off lid with moulded matrix.</p> <p>Dimensions (WxDxH): 76 x 287 x 36mm.</p> <p>Max. tube height: 50mm.</p>	Natural	E2100-1100	5	£19.50
		Blue	E2100-1101	5	£19.50
		Green	E2100-1102	5	£19.50
		Red	E2100-1104	5	£19.50
		Black*	E2100-1108	5	£19.50



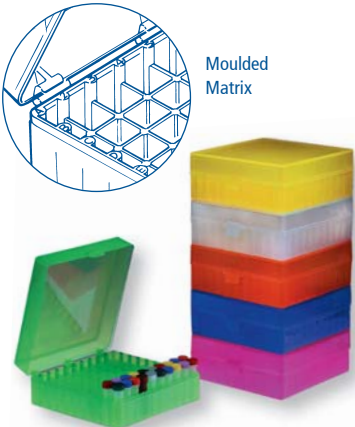

\* Black box to completely block out light for light-sensitive samples.

# Polypropylene Storage Boxes

Polypropylene provides high chemical resistance. Temperature use: -90°C to 121°C. Autoclavable.

StarStore 100-Place Storage Box					
	Description	Colour	Cat. No.	Pack Size	Price
 <p>Moulded Matrix</p>	<p><b>StarStore 100</b> polypropylene storage box. Our most popular storage box! 100 fixed 13 x 13mm dividers. Use for 1.5/2.0ml microcentrifuge tubes or screw cap microtubes. Moulded reference grid inside (A–J, 1–10). Hinged, lockable lid with positioning lugs for stable stacking. Dimensions (WxDxH): 140 x 155 x 55mm.</p>	Natural	I 2310-5800	5	£22.26
		Neon Blue	I 2310-5841	5	£22.26
		Neon Green	I 2310-5842	5	£22.26
		Neon Orange	I 2310-5843	5	£22.26
		Neon Pink	I 2310-5844	5	£22.26
		Neon Yellow	I 2310-5846	5	£22.26
		Mixed Neon*	I 2310-5848	5	£22.26
		<p>StarStore 100 boxes can be used with the stainless steel freezer racking on pages 115 and 119</p> 			



\* Mixed pack contains one of each neon colour.

50-Place Storage Boxes					
	Description	Colour	Cat. No.	Pack Size	Price
	<p><b>StarStore 50 Neon, Hinged</b> polypropylene storage box. Smaller version of the StarStore 100 (see above). Fixed 13 x 13mm dividers for the storage of 50 x 1.5/2.0ml microcentrifuge tubes. Moulded reference grid inside (A–J, 1–5). Hinged, lockable lid with positioning lugs for stable stacking. Dimensions (WxDxH): 140 x 80 x 55mm.</p>	Natural	I 2350-5800	5	£20.06
		Neon Blue	I 2350-5841	5	£22.26
		Neon Green	I 2350-5842	5	£22.26
		Neon Orange	I 2350-5843	5	£22.26
		Neon Pink	I 2350-5844	5	£22.26
		Neon Yellow	I 2350-5846	5	£22.26
		Mixed Neon*	I 2350-5848	5	£22.26
<p>These boxes are supplied with a removable acetate grid that sits under the lid</p> 	<p><b>StarStore 50 (Stackable)</b> polypropylene storage box. Fixed 13 x 13mm dividers for the storage of 50 x 1.5/2.0ml microcentrifuge tubes. Supplied with removable acetate grid that sits under the lid. Lift-off lid with positioning lugs for stable stacking. Dimensions (WxDxH): 144 x 75 x 35mm. Max. tube height: 45mm.</p>	Natural	E2450-5000	5	£33.39
		Blue	E2450-5001	5	£33.39
		Green	E2450-5002	5	£33.39
		Pink	E2450-5004	5	£33.39
		Yellow	E2450-5006	5	£33.39
		Mixed**	E2450-5099	5	£33.39
		<b>50-Place Acetate Grid</b> for use with StarStore 50.	Clear	I 2350-1025	25
<p>Can be used with the optional acetate grid that sits under the lid</p> 	<p><b>StarStore 50</b> polypropylene storage box. Fixed 13 x 13mm dividers for the storage of 50 x 1.5/2.0ml microcentrifuge tubes. Optional, removable acetate grid that sits under the lid. Transparent, lift-off lid. Dimensions (WxDxH): 146 x 76 x 38mm.</p>	Natural	E2350-5009	5	£16.17
		<b>50-Place Acetate Grid</b> for use with StarStore 50.	Clear	I 2350-1025	25
	<p><b>StarStore 50 Jr</b>, small polypropylene storage box. Fixed 10 x 10mm dividers for the storage of 50 x 0.5ml microcentrifuge tubes. Lift-off lid with moulded matrix (A–E 1–10). Dimensions (WxDxH): 121 x 62 x 37mm. Max. tube height: 60mm.</p>	Natural	E2305-6009	5	£15.54

\* Mixed pack contains one of each neon colour. \*\*Mixed pack contains one of each colour.

## Polypropylene Storage Boxes

The high-profile storage boxes below are suitable for use with screw cap microtubes (see pages 64–65) and other taller tubes up to 53mm high. Polypropylene provides high chemical resistance. Temperature use: -90°C to 121°C. Autoclavable.

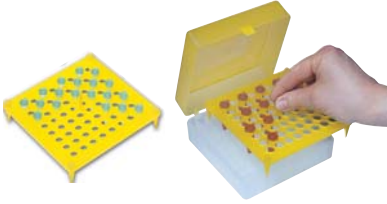
High-Profile Storage Boxes					
	Description	Colour	Cat. No.	Pack Size	Price
	<p><b>New!</b></p> <p><b>200-place</b> polypropylene storage box, ideal for storing taller tubes (eg. screw cap microtubes) up to 53mm high. Fixed 12.5 x 12.5mm dividers. Moulded reference grid inside (A–J, 1–20). Hinged lid with positioning lugs for stable stacking. Dimensions (WxDxH): 275 x 155 x 64mm.</p>	Natural	E2200-1000	5	£65.00
		Black*	E2200-1008	5	£65.00
	<p><b>100-place</b> two-tone polypropylene storage box, ideal for storing taller tubes (eg. screw cap microtubes) up to 53mm high (or 64 x 1.5/2.0ml microcentrifuge tubes if using the rack insert featured below). Fixed 12.5 x 12.5mm dividers. Moulded reference grid inside (A–J, 1–10). Hinged lid with positioning lugs for stable stacking. Dimensions (WxDxH): 140 x 155 x 64mm.</p>	Natural/Natural	E2100-5000	5	£38.96
		Natural/Blue	E2100-5001	5	£38.96
		Natural/Green	E2100-5002	5	£38.96
		Natural/Red	E2100-5004	5	£38.96
		Natural/Yellow	E2100-5006	5	£38.96
		Black/Black*	E2100-5008	5	£38.96
	<p><b>64-place tube rack insert for 100-place box</b></p> <p>This rack can be used inside the 100-place rack above to convert the box to hold 64 x 1.5/2.0ml microcentrifuge tubes. Moulded reference grid (A–H, 1–8). Dimensions (WxDxH): 135 x 135 x 54mm.</p>	Natural	E2115-5000	5	£22.26
		Blue	E2115-5001	5	£22.26
		Green	E2115-5002	5	£22.26
		Red	E2115-5004	5	£22.26
		Yellow	E2115-5006	5	£22.26

\* Black box to completely block out light for light-sensitive samples.

Polypropylene storage boxes. Temperature use: -90°C to 121°C. Autoclavable.

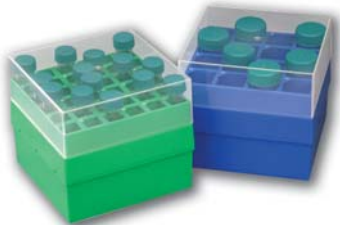
Centrifuge Tube Storage Boxes					
	Description	Rack Colour	Cat. No.	Pack Size	Price
	<p><b>Centrifuge tube storage / transport boxes</b></p> <p>Green box holds 36 x 15ml tubes. Blue box holds 16 x 50ml tubes. Clear lift-off lid. Highly visible, white printed matrix on base. Base can be removed for use in the water bath. For use in temperatures -90°C to 121°C. Autoclavable. Dimensions (WxDxH): 145 x 145 x 127mm.</p>	Green (for 15ml)	E9025-3615	1	£10.61
		Blue (for 50ml)	E9025-1650	1	£10.61

Cuvette Storage Box					
	Description	Colour	Cat. No.	Pack Size	Price
	<p><b>Cuvette storage box</b></p> <p>Holds 12 cuvettes up to 51mm high. The higher profile lid accommodates the tallest of spectrophotometer cells, including those with covers or stoppers. Autoclavable. Hinged lid with lugs for stable stacking. Dimensions (WxDxH): 121 x 115 x 60mm.</p>	Natural	E2396-1200	1	£10.29



## Cryogenic Storage Boxes

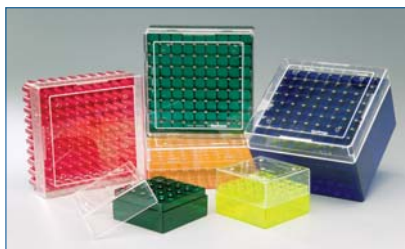

### Coloured cryogenic storage boxes

A range coloured polycarbonate storage boxes for use in ultra-low temperatures. Boxes can be submerged in LN<sub>2</sub>. A choice of different colour bases allows you to colour coordinate your samples for easy identification.

Temperature use: -196°C to 121°C. Autoclavable.

Coloured Polycarbonate Storage Boxes					
	Description	Base Colour	Cat. No.	Pack Size	Price
	<b>25-place</b> polycarbonate storage box. Coloured base with crystal-clear, lift-off lid. Fixed 13 x 13mm grid dividers. Printed matrix on dividers. Dimensions (WxDxH): 76 x 76 x 54mm. Max. tube height: 49mm.	Blue	E2381-5001	5	£27.83
		Green	E2381-5002	5	£27.83
		Orange	E2381-5003	5	£27.83
		Red	E2381-5004	5	£27.83
		Yellow	E2381-5006	5	£27.83
		Mixed*	E2381-5099	5	£27.83
	<b>81-place</b> polycarbonate storage box. Coloured base with crystal-clear, lift-off lid. Fixed 13 x 13mm grid dividers. Printed matrix on grid dividers. Dimensions (WxDxH): 133 x 133 x 54mm. Max. tube height: 49mm.	Blue	E2382-5001	5	£33.39
		Green	E2382-5002	5	£33.39
		Orange	E2382-5003	5	£33.39
		Red	E2382-5004	5	£33.39
		Yellow	E2382-5006	5	£33.39
		Mixed*	E2382-5099	5	£33.39
	<b>81-place, tall</b> polycarbonate storage box. Coloured base with crystal-clear, lift-off lid. Fixed 13 x 13mm grid dividers. Printed matrix on grid dividers. Dimensions (WxDxH): 133 x 133 x 95mm. Max. tube height: 90mm.	Blue	E2382-6001	5	£50.09
		Green	E2382-6002	5	£50.09
		Orange	E2382-6003	5	£50.09
		Red	E2382-6004	5	£50.09
		Yellow	E2382-6006	5	£50.09
		Mixed*	E2382-6099	5	£50.09
	<b>100-place</b> polycarbonate storage box. Coloured base with crystal-clear, lift-off lid. Fixed, 13 x 13mm pronged dividers. Printed matrix on pronged dividers. Dimensions (WxDxH): 133 x 133 x 54mm. Max. tube height: 49mm.	Blue	E2383-5001	5	£38.96
		Green	E2383-5002	5	£38.96
		Orange	E2383-5003	5	£38.96
		Red	E2383-5004	5	£38.96
		Yellow	E2383-5006	5	£38.96
		Mixed*	E2383-5099	5	£38.96

\*Contains one of each colour.

Cryogenic storage boxes above  
 can be used with the freezer  
 racking on pages 114–115  
 and pages 118–119



## Cryogenic Storage Boxes & Racks

Zylar resin box for ultra-low temperature storage. Temperature use: -196°C to 121°C. Autoclavable.



Zylar Resin Storage Box					
	Description	Colour	Cat. No.	Pack Size	Price
	<b>StarStore 81Z</b> zylar resin storage box. Fixed 13mm x 13mm dividers. Transparent lift-off lid with frosted writing panels on sides. Vent strips in base for safety and to aid lid removal. Optional removable acetate grid that sits under the lid. Dimensions (WxDxH): 130 x 130 x 45mm	Natural	E2301-5309	5	£56.60
	<b>81-place acetate grid</b> for use with StarStore 81Z	n/a	I 2381-1025	25	£16.70

Image shows box with optional acetate grid. The boxes can be used in the freezer racking on pages 114–115 and pages 118–119.

Polycarbonate boxes for ultra-low temperature storage. Temperature use: -196°C to 121°C. Autoclavable.

White Polycarbonate Storage Boxes					
	Description	Type	Cat. No.	Pack Size	Price
	<b>Cryogenic storage boxes</b> 81-place box has grid dividers. 100-place box has pronged dividers. White polycarbonate base with transparent, keyed (one-way) lift-off lid with printed reference grid. Drain holes on base for venting and safety. Dimensions (WxDxH): 130 x 130 x 55mm.	81-place	I 2381-2305	5	£33.39
		100-place	I 2510-5005	5	£33.39

The boxes can be used in the freezer racking on pages 114–115 and pages 118–119.

Polypropylene provides high chemical resistance. Temperature use: -90°C to 121°C. Autoclavable.

**New!**

Polypropylene Cryogenic Lock Racks					
	Description	Colour	Cat. No.	Pack Size	Price
	<b>Cryogenic lock rack</b> 50-place polypropylene rack for skirted cryogenic vials. The vials lock into the rack for easy one-handed cap removal. Autoclavable. Anti-skid rubber feet for stability on the bench. Dimensions (WxDxH): 20 x 10 x 55mm.	Blue	E2350-4001	4	£70.14
		Red	E2350-4002	4	£70.14
		Violet	E2350-4005	4	£70.14

StarRack Multi					
	Description	Rack Colour	Cat. No.	Pack Size	Price
	<b>StarRack Multi</b> 84-Place rack, ideal for taller tubes (eg. cryogenic storage vials, 12x75 Tubes etc) up to 13mm diameter. Made from autoclavable, impact resistant acetal polymer. Convenient carrying handles on either end of the rack. Ideal for use in the waterbath as the rack will sink to the bottom without toppling over! Dimensions (WxDxH): 293 x 115 x 65mm.	Mixed (contains one each of blue, green, violet, yellow and orange)	E2396-9759	5	£60.06

NOTE: this rack is not suitable for use with microcentrifuge tubes.

# Storage Racks

Polypropylene provides high chemical resistance. Temperature use: -90°C to autoclave.

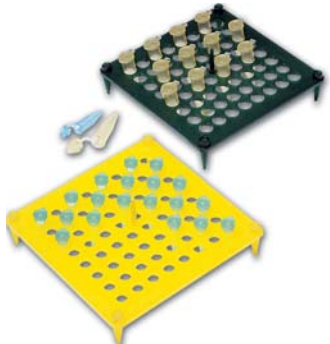
64-Place Tube Racks					
	Description	Colour	Cat. No.	Pack Size	Price
	<b>64-Place tube rack for 1.5/2.0ml tubes</b> Use on the bench with 64 x 1.5/2.0ml microcentrifuge tubes. (Racks must be stacked in pairs to accept the tubes.) Can also be used in the 100-place box (see page 102). Moulded reference grid (A–H, 1–8). Dimensions (WxDxH): 135 x 135 x 54mm.	Natural	E2115-5000	5	£22.26
		Blue	E2115-5001	5	£22.26
		Green	E2115-5002	5	£22.26
		Red	E2115-5004	5	£22.26
		Yellow	E2115-5006	5	£22.26
	<b>64-Place tube rack for 0.5ml tubes</b> Polypropylene rack for use on the bench with 0.5ml microcentrifuge tubes. Can be stacked when full. Moulded reference grid (A–H, 1–8). Dimensions (WxDxH): 135 x 135 x 54mm.	Natural	E2105-5000	5	£22.26
		Blue	E2105-5001	5	£22.26
		Green	E2105-5002	5	£22.26
		Red	E2105-5004	5	£22.26
		Yellow	E2105-5006	5	£22.26

StarRack 80					
	Description	Colour	Cat. No.	Pack Size	Price
	<b>StarRack 80</b> Polypropylene fraction collection rack. Holds 80 x 1.5/2.0ml tubes. Max. tube diam. 11mm. Alpha numeric reference grid (A–E, 1–16). This rack does not have a lid, but an optional, natural polypropylene storage box with a hinged lid (see below) into which the racks can be used for extra security during freezer storage. Dimensions (WxDxH): 226 x 67 x 28mm.	Natural	E2380-5000	5	£12.60
		Blue, Green, Orange, Red, Violet, Yellow or Black*	E2380-500#	5	£13.34
		Mixed**	E2380-5008	5	£13.34
		Neon Blue	E2380-5041	5	£14.44
		Neon Green	E2380-5042	5	£14.44
		Neon Orange	E2380-5043	5	£14.44
		Neon Pink	E2380-5044	5	£14.44
		Neon Yellow	E2380-5046	5	£14.44
		Mixed Neon**	E2380-5048	5	£14.44
	<b>StarRack 80 storage box</b> Dimensions (WxDxH): 236 x 85 x 52mm.	Natural	E2390-5000	5	£13.97

\*To order colour required, replace # as last digit of Cat. No. with: 1 for Blue, 2 for Green, 3 for Orange, 4 for Red, 5 for Violet, 6 for Yellow, 7 for Black.

\*\*Mixed pack contains one each of blue, green, orange, red and yellow. Mixed Neon pack contains one of each neon colour.





**New!**

Expanding Work/Storage Rack					
	Description	Colour	Cat. No.	Pack Size	Price
	<b>Expanding work/storage rack</b> Reduce sample handling time with this expanding rack. The rack opens to allow sufficient hand space for sample manipulation, and then closes back to its compact footprint for storage in the fridge or freezer. The clear lid 'locks' the rack together for safe storage. Stackable. Fits in standard freezer racking. Holds 64 x 1.5/2.0ml tubes. Autoclavable. Dimensions (WxDxH): Closed: 133 x 133 x 53mm (with lid). Open: 310 x 128 x 33.5mm.	Grey	E2364-1000	1	£23.00

Can be used in the freezer racking on pages 114–115 and 118–119.

## Storage Racks

A range of chemically-resistant epoxy coated wire racks. Autoclavable

Wire Storage Racks					
	Description	Rack Colour	Cat. No.	Pack Size	Price
	<p><b>Wire racks for 7.0ml bijou containers</b></p> <p>Chemically resistant epoxy coated wire racks. Suitable for 7.0ml bijou containers or any other low-profile tube up to 20mm diam.</p> <p>Autoclavable.</p> <p>Dimensions (WxDxH): 12 place: 164 x 64 x 32mm. 50 place: 271 x 145 x 32mm.</p>	12-Place (2 x 6 format)	E2396-1612	1	£16.00
		50-Place (10 x 5 format)	E2396-1650	1	£19.00
	<p><b>Wire racks for 30ml universal containers</b></p> <p>Chemically resistant epoxy coated wire racks. Suitable for 30ml universal containers or any other low-profile tube up to 28mm diam.</p> <p>Autoclavable.</p> <p>Dimensions (WxDxH): 12 place: 212 x 79 x 60mm. 50 place: 355 x 189 x 60mm.</p>	12-Place (2 x 6 format)	E2396-1712	1	£17.50
		50-Place (10 x 5 format)	E2396-1750	1	£19.50
	<p><b>15-place rack for 15ml tubes</b></p> <p>Chemically resistant epoxy coated wire rack. Ideal for use with conical tubes. Max. tube diameter: 20mm.</p> <p>Autoclavable.</p> <p>Dimensions (WxDxH): 127 x 76 x 176mm.</p>	Blue	E2396-1515	1	£18.90
	<p><b>8-place rack for 50ml tubes</b></p> <p>Chemically resistant epoxy coated wire rack. Ideal for use with conical tubes. Max. tube diameter: 30mm.</p> <p>Autoclavable.</p> <p>Dimensions (WxDxH): 147 x 80 x 89mm.</p>	Blue	E2396-1550	1	£18.90

Centrifuge Tube Storage					
	Description	Rack Colour	Cat. No.	Pack Size	Price
	<p><b>StarRack Multi for 15ml or 50ml tubes</b></p> <p>60-place rack for 15ml tubes (16mm holes). 18-place rack for 50ml tubes (30mm holes).</p> <p>Made from autoclavable, impact resistant acetal polymer. Convenient carrying handles on either end of the rack. Ideal for use in the waterbath as they will sink to the bottom without toppling over!</p> <p>Dimensions (WxDxH): 293 x 115 x 65mm.</p>	Mixed (contains one each of blue, green, violet, yellow and orange)	E2396-9769 (15ml Tubes)	5	£60.06
			E2396-9779 (50ml Tubes)	5	£60.06

## Multi-Tube Racks



Polypropylene provides high chemical resistance. Temperature use: -90°C to 121°C. Autoclavable.

Double-Sided StarRacks					
	Description	Rack Colour	Cat. No.	Pack Size	Price
Double-sided! 	<b>StarRack 40</b> double-sided polypropylene rack with moulded matrix on both sides (A–D, 1–9). Holds: 32 x 0.5ml tubes AND 8 x 1.5/2.0ml tubes on one side, 32 x 1.5/2.0ml tubes AND 8 x 0.5ml tubes on the other. Transparent, lift-off lid. Dimensions (WxDxH): 170 x 80 x 28mm. 170 x 80 x 50mm (with lid).	Natural	E2340-4000	1	£7.77
		Neon Blue	E2340-4041	1	£7.77
		Neon Green	E2340-4042	1	£7.77
		Neon Orange	E2340-4043	1	£7.77
		Neon Pink	E2340-4044	1	£7.77
		Neon Yellow	E2340-4046	1	£7.77
		Mixed Neon*	E2340-3099	5	£37.80
		Double-sided! 	<b>StarRack 64</b> double-sided polypropylene rack with moulded matrix on both sides (A–H, 1–8). Holds: 64 x 0.5ml tubes on one side, 64 x 1.5/2.0ml tubes on the other. Transparent, lift-off lid. Dimensions (WxDxH): 130 x 130 x 30mm. 130 x 130 x 50mm (with lid).  StarRack 64 can be used in the freezer racking on pages 114–115 and pages 118–119	Natural	E2364-1010
Blue	E2364-1011			1	£5.57
Green	E2364-1012			1	£5.57
Orange	E2364-1013			1	£5.57
Red	E2364-1014			1	£5.57
Violet	E2364-1015			1	£5.57
Yellow	E2364-1016			1	£5.57
Black	E2364-1018			1	£5.57
Mixed**	E2364-6099			5	£24.47
Neon Blue	E2364-1041			1	£6.09
Neon Green	E2364-1042			1	£6.09
Neon Orange	E2364-1043			1	£6.09
Neon Pink	E2364-1044			1	£6.09
Neon Yellow	E2364-1046			1	£6.09
Mixed Neon*	E2364-6048	5	£26.67		
Double-sided! 	<b>StarRack 96</b> double-sided polypropylene rack with moulded matrix on both sides (A–H, 1–12). Holds: 96 x 0.5ml tubes on one side, 96 x 1.5/2.0ml tubes on the other. Transparent, lift-off lid. Dimensions (WxDxH): 222 x 114 x 28mm. 222 x 120 x 50mm (with lid).	Natural	E2396-0010	1	£7.77
		Blue	E2396-0011	1	£8.40
		Green	E2396-0012	1	£8.40
		Orange	E2396-0013	1	£8.40
		Red	E2396-0014	1	£8.40
		Violet	E2396-0015	1	£8.40
		Yellow	E2396-0016	1	£8.40
		Black	E2396-0018	1	£8.40
		Mixed**	I2396-5099	5	£38.96
		Neon Blue	E2396-0041	1	£8.40
		Neon Green	E2396-0042	1	£8.40
		Neon Orange	E2396-0043	1	£8.40
		Neon Pink	E2396-0044	1	£8.40
		Neon Yellow	E2396-0046	1	£8.40
Mixed Neon*	I2396-5048	5	£38.96		



\*Mixed neon packs contain one of each neon colour. \*\*Mixed packs contain one each of blue, green, orange, red and yellow.

## Multi-Tube Racks

Versatile racking systems. Polypropylene provides high chemical resistance. Temperature use: -90°C to 121°C. Autoclavable.

Combi Racks						
	Description	Colour	Cat. No.	Pack Size	Price	
	<b>Combi-Mini</b> polypropylene rack Each rack contains 80 holes: 4 x 50ml tubes (30mm) 12 x 15ml tubes (17mm) 32 x 1.5/2.0ml tubes (12mm) 32 x 0.5ml tubes (8mm) Dimensions (WxDxH): 171 x 91 x 54mm.		Natural	E2345-1000	1	£5.57
			Neon Blue	E2345-1041	1	£5.57
			Neon Green	E2345-1042	1	£5.57
			Neon Orange	E2345-1043	1	£5.57
			Neon Pink	E2345-1044	1	£5.57
			Neon Yellow	E2345-1046	1	£5.57
			Mixed Neon*	E2345-1099	5	£26.67
			Two slightly different versions available, both designed to hold an array of tubes  	<b>Combi-Max 92</b> polypropylene rack Each rack contains 92 holes: 8 x 50ml tubes (30mm) 20 x 20mm diam. tubes (21mm) 24 x 15ml tubes (17mm) 40 x 12/13mm diam tubes (13mm) Dimensions (WxDxH): 198 x 114 x 95mm.	Natural	E2346-1000
Neon Blue	E2346-1041	1			£16.17	
Neon Green	E2346-1042	1			£16.17	
Neon Orange	E2346-1043	1			£16.17	
Neon Pink	E2346-1044	1			£16.17	
Neon Yellow	E2346-1046	1			£16.17	
Mixed Neon*	E2346-1099	5			£77.91	
<b>Combi-Max 96</b> polypropylene rack Each rack contains 96 holes: 12 x 25ml tubes (27mm) 20 x 20mm diam. tubes (21mm) 24 x 15ml tubes (17mm) 40 x 12/13mm diam tubes (13mm) Dimensions (WxDxH): 198 x 114 x 95mm.	Blue	E2347-1001		1	£16.17	
	Green	E2347-1002		1	£16.17	
	Orange	E2347-1003		1	£16.17	
	Red	E2347-1004		1	£16.17	
	Violet	E2347-1005		1	£16.17	
	Mixed**	E2347-1099		5	£77.91	

\*Mixed packs contain one of each neon colour. \*\* Mixed packs contain one of each colour.

TwisStar Rack					
	Description	Colour	Cat. No.	Pack Size	Price
 	<b>TwisStar</b> – polypropylene rack comprising four sections that can be rotated and locked together to achieve various configurations for holding different tubes and a PCR plate. Combined, the TwisStar (four colour sections) holds up to: 50ml tubes (max. 30mm $\emptyset$ ) x 2 per section 15ml tubes (max. 18mm $\emptyset$ ) x 8 per section 1.5/2.0ml tubes (max. 11mm $\emptyset$ ) x 12 per section 0.5ml tubes (max. 8mm $\emptyset$ ) x 6 per section PCR Plate 1 plate across 2 sections 8-Tube PCR Strips x 6 per section 12-Tube PCR Strips x 8 across 2 sections 0.2ml PCR Tubes x 48 per section Dimensions (WxDxH): 257 x 108 x 108mm (combined). 69 x 108 x 108mm (individual section) .	Yellow, Blue, Green & Red	E2344-1099	1	£28.98

Totally Tubular™					
	Description	Colour	Cat. No.	Pack Size	Price
	<b>Totally Tubular™</b> Four polypropylene racks in a support tray. Each of the four racks contains 29 holes for: 2 x 50ml tubes (30mm) 6 x 15ml tubes (17mm) 9 x 1.5/2.0ml tubes (12mm) 12 x 0.5ml tubes (11mm) Ind. rack dimensions (WxDxH): 93 x 93 x 48mm.	Yellow, Blue, Green & Red	I 2344-1000	1 Tray, 4 Cubes	£27.83
		Neon Green, Neon Orange, Neon Pink & Neon Yellow	I 2344-1040	1 Tray, 4 Cubes	£28.98

## Multi-Tube Racks

Polypropylene provides high chemical resistance. Temperature use: -90°C to 121°C. Autoclavable.

Connect-A-Rack					
	Description	Colour	Cat. No.	Pack Size	Price
 <p>Double-sided!</p>	<p><b>Connect-A-Rack</b> polypropylene double-sided rack. Can be connected side by side or one on top of the other. Holds 80 x tubes up to 12mm diam. on one side, 60 x 0.2/0.5ml tubes on the other. Frosted writing area on sides of rack. Very small footprint to save on valuable bench space. Supplied with two removable handles and connecting pins. Dimensions (WxDxH): 223 x 67 x 27mm (without lid). Lid supplied separately.</p> <p><b>Transparent Lid</b> for use with Connect-A-Rack</p>	Blue	E2380-6001	5	£12.81
		Green	E2380-6002	5	£12.81
		Orange	E2380-6003	5	£12.81
		Pink	E2380-6004	5	£12.81
		Yellow	E2380-6006	5	£12.81
		Clear	E2380-6000	5	£7.77

Three-Tier Multi-Tube Rack					
	Description	Colour	Cat. No.	Pack Size	Price
	<p><b>Three-Tier Multi Tube Rack</b></p> <p>Polypropylene racks that can be used individually or connected side by side. Each rack has three tiers, each of which holds a different size tube:</p> <p>Top: 12 x 1.5/2.0ml tubes Middle: 14 x 0.5ml tubes Bottom: 24 x 0.2ml tubes.</p> <p>Dimensions (WxDxH): 123 x 164 x 62mm.</p>	Mixed (one rack each of blue, green, violet, yellow, orange and natural)	E2313-1009	6	£20.06

## PCR Sample Racks

StarPCR Work Rack					
	Description	Rack Colour	Cat. No.	Pack Size	Price
	<p><b>StarPCR work rack</b></p> <p>Sturdy 96-place polypropylene rack for use with either 1 x 96-well PCR plate, or 0.2ml PCR tubes or strips. Positive snap-in transparent lid guarantees safe closure. Stackable with or without lid. Suitable for use down to -90°C. Dimensions (WxDxH): 138 x 98 x 39mm (with lid). NOTE: Not autoclavable.</p>	Mixed (contains one each of blue, green, red, violet, yellow)	E2396-5240	5	£32.24

Double-Sided PCR Work Rack					
	Description	Rack Colour	Cat. No.	Pack Size	Price
 <p>Hinged lid!</p>	<p><b>Double-sided PCR work rack</b></p> <p>Double-sided polypropylene rack with transparent (detachable), hinged lid which has:</p> <p>168 x 0.2ml wells plus 12 x 1.5ml wells on one side, and 40 x 0.5ml wells plus 12 x 1.5ml wells on the other</p> <p>Temperature use: -90°C to 121°C. Autoclavable. Dimensions (WxDxH): 206 x 131 x 54mm (with lid).</p>	Mixed (contains one each of blue, green, orange pink, yellow)	E2396-0599	5	£32.24

## PCR Sample Racks



### PCR Workstation

Polypropylene racks for the storage of PCR tubes, PCR strips and PCR plates, as well as 0.5ml and 1.5/2.0ml microcentrifuge tubes. Moulded, alpha-numeric matrix. The two different sized racks (Rack A and Rack B) can be combined to form the complete PCR Workstation. Racks can either be purchased separately or together as a complete workstation. Each rack is supplied with its own transparent, lift-off lid. Temperature use: -90°C to 121°C. Autoclavable.

PCR Workstation					
	Description	Colour	Cat. No.	Pack Size	Price
	<b>Rack A only (Satellite Rack)</b> 96 wells to hold 0.2ml PCR tubes, PCR strips or 1 x 96-well PCR plate. Each rack supplied with its own transparent, lift-off lid. Dimensions (WxDxH): 127 x 87 x 33 mm (with lid).	Neon Blue*	E2396-1641	1	£5.04
		Neon Green*	E2396-1642	1	£5.04
		Neon Orange*	E2396-1643	1	£5.04
		Neon Pink*	E2396-1644	1	£5.04
		Neon Yellow*	E2396-1646	1	£5.04
		Mixed Neon**	E2396-9649	5	£23.42
	<b>Rack B only (Workstation Rack)</b> Holds 32 x 0.2ml PCR tubes, 16 x 0.5ml tubes (PCR or MCT), and 24 x 1.5/2.0 ml microcentrifuge tubes. Each rack supplied with its own transparent, lift-off lid. Dimensions (WxDxH): 215 x 115 x 50 mm (with lid).	Neon Blue*	E2396-1651	1	£11.13
		Neon Green*	E2396-1652	1	£11.13
		Neon Orange*	E2396-1653	1	£11.13
		Neon Pink*	E2396-1654	1	£11.13
		Neon Yellow*	E2396-1656	1	£11.13
		Mixed Neon**	E2396-9659	5	£52.29
	<b>Racks A &amp; B (complete PCR Workstation)</b> Rack A (without lid) can be inserted into the designated area of Rack B. Each rack supplied with its own transparent, lift-off lid.	Neon Blue*	E2396-9691	1+1	£16.17
		Neon Green*	E2396-9692	1+1	£16.17
		Neon Orange*	E2396-9693	1+1	£16.17
		Neon Pink*	E2396-9694	1+1	£16.17
		Neon Yellow*	E2396-9696	1+1	£16.17
		Mixed Neon**	E2396-9669	5+5	£75.71

\* Pack contains one rack with lid. \*\*Pack contains one rack of each colour and five lids.

PCR Lock-Rack					
	Description	Rack Colour	Cat. No.	Pack Size	Price
	<b>PCR Lock-Rack</b> Polypropylene racks which lock together to make larger racks. Transparent lid fits over two sections locked together. Each section holds 24 x 1.5/2.0ml tubes, 16 x 0.5ml tubes and 60 x 0.2ml tubes. Two sections locked together can hold a 96-Well PCR plate. Dimensions (WxDxH): 133 x 107 x 56mm (2 sections with lid).	Mixed (contains one section each of blue, green, red, violet, yellow)	E2344-2099	4 Racks, 2 Lids	£25.10



## Chiller Racks



### StarChill high performance chiller racks

Maintain a fridge environment on the benchtop or on your robot! The centre section of StarChill racks changes colour when frozen. It then gradually turns back to its original colour as it warms up, thus giving an instant, visual-indication of the temperature.

StarChill Chiller Racks					
	Description	Colour	Cat. No.	Pack Size	Price
	<b>StarChill PCR</b> 96-well rack with lid, for use with: 0.2ml tubes (single or strip) or 0.2ml 96-well PCR Plate Temperature colour change: 7°C. Estimated time at 4°C: 3+ hours* Dimensions (WxDxH): 141 x 99 x 44mm (with lid); 141 x 99 x 38mm (without lid)	Pink (warm) Purple (cold)	E2396-2004	2	£46.73
		Yellow (warm) Green (cold)	E2396-2006	2	£46.73
	<b>StarChill MCT</b> 24-well rack with lid, for use with: 0.5, 1.5 & 2.0ml microcentrifuge or screw cap tubes Temperature colour change: 7°C Estimated time at 4°C: 3+ hours* Dimensions (WxDxH): 146 x 105 x 70mm (with lid); 146 x 105 x 65mm (without lid)	Pink (warm) Purple (cold)	E2396-5634	1	£38.96
		Yellow (warm) Green (cold)	E2396-5636	1	£38.96
	<b>StarChill SBS</b> 96-well rack (no lid), for use on AUTOMATED SYSTEMS with 0.2ml tubes (single or strip) or a 0.2ml 96-well PCR Plate Temperature colour change: 7°C Estimated time at 4°C: 2+ hours* Dimensions (WxDxH): 128 x 85 x 26mm	Pink (warm) Purple (cold)	E2396-5654	2	£41.16
		Yellow (warm) Green (cold)	E2396-5656	2	£41.16

\*Time will vary, depending on ambient temperature. All StarChill racks must be frozen for a minimum of 8 hours at -20°C before use. Not Autoclavable.

## Cooler Containers



### Containers for temperature sensitive samples



Rigid moulded polyurethane containers for chilling your temperature sensitive samples. The Cooler Containers provide excellent insulation properties for very low temperature use with ice and ice-salt slurries. The snug-fitting lid minimises evaporation. Carrying handles. Handy pour spout for easy emptying. Tapered sides allow stacking when not in use. Temperature use: -196°C to 240°C.

Cooler Containers				
Cat. No.	Description	Dimensions (WxDxH)	Pack Size	Price
E2396-6008	4 Litre Round Cooler Container, Black	235 Ø x 180mm	1	£72.35
E2396-6002	1 Litre Square Cooler Container, Green	270 x 195 x 115mm	1	£50.09
E2396-6001	4 Litre Oblong Cooler Container, Blue	380 x 250 x 140mm	1	£72.35
E2396-6004	9 Litre Oblong Cooler Container, Red	521 x 295 x 165mm	1	£94.61

## Transport Cases & Coolers

Transport Cases & Coolers					
	Description	Colour	Cat. No.	Pack Size	Price
  <p>Protects valuable enzymes from temperature fluctuation due to frost-free cycles, power loss or open freezer doors</p>	<p><b>Benchtop Cooler / Transport Case</b></p> <p>Small, polypropylene, case-style holder filled with ice-gel, for use with 48 x 1.5/2.0ml tubes. Handy note panel inside the lid.</p> <p>Maintains temperatures of:                      -15°C or lower, for 4 hours if frozen to -20°C.                      -15°C or lower, for 6 hours if frozen to -23°C.</p> <p>Dimensions (WxDxH): 215 x 200 x 95mm.                      Weight 2.5kg.                      NOTE: Not Autoclavable.</p>	Black	16348-1515	1	£194.78
  <p>Protects cells &amp; biologicals stored in -70°C freezers. Use for added protection when shipping valuable samples on dry ice</p>	<p><b>Cryo Cooler / Transport Case</b></p> <p>Small, polypropylene, case-style holder filled with ice-gel, for use with 42 x 1.5/2.0ml tubes. Handy note panel inside the lid.</p> <p>When frozen to -70°C the Cryo Cooler will take up to 10 hours to raise to a temperature of -10°C.</p> <p>Dimensions (WxDxH): 215 x 200 x 95mm.                      Weight 2.5kg.                      NOTE: Must be frozen to -70°C for a minimum of 24 hours before use. Not autoclavable.</p>	Black	16342-4270	1	£194.78
  <p>Perfect for the transportation of a small number of samples</p>	<p><b>Mini Cooler</b></p> <p>Small rack filled with with ice-gel for 8 x 1.5/2.0ml tubes. Hinged, transparent lid with snap-catch.</p> <p>Maintains -15°C or below for up to 1 hour.</p> <p>Dimensions (WxDxH): 120 x 85 x 90mm.                      Weight: 750g.                      NOTE: Must be frozen to -20°C for a minimum of 24 hours before use. Not autoclavable.</p>	Silver	16308-1515	1	£67.94
  <p>Maintain low-temperature storage of reagents, cells and enzymes removed from the freezer</p>	<p><b>CryoSecure®</b></p> <p>Double-sided racks filled with ice-gel, for use with 20 x 0.5ml tubes on one side, or 20 x 1.5/2.0ml tubes on the other.</p> <p>White rack maintains 0°C for a minimum of 5 hours.                      Blue rack maintains -10°C to -20°C for up to 3 hours.</p> <p>Dimensions (WxDxH): 172 x 110 x 105mm with lid.                      NOTE: Not autoclavable.</p>	White (0°C Rack)	12312-2720	1	£59.01
		Blue (-20°C Rack)	12312-2721	1	£59.01

## Ice Bath / Floating Rack

Ice Bath / Floating Rack					
	Description	Colour	Cat. No.	Pack Size	Price
  <p>Use the rack in the hinged storage box supplied, and pack with ice for a mini, ice-bath, or remove the insert and use to float tubes in the waterbath!</p>	<p><b>Ice Bath / Floating Rack</b></p> <p>A versatile rack that can be used as a mini ice bath, or remove the insert and float tubes in the waterbath. Holds 24 x 1.5/2.0ml tubes, or 14 x 0.5ml tubes, or a combination of both</p> <p>Temperature use: -80°C to 121°C. Autoclavable.</p>	Blue	12324-5000	5	£37.38

# Stainless Steel Storage

## Stainless steel tube racks

A range of mirror-finish stainless steel (SS) tube racks for use on the bench or in the fridge or freezer.



Stainless Steel Tube Racks				
Cat. No.	Description	Max. Cap Ø	Rack Dimensions (WxDxH)	Price
I2671-7211	72-Place Single SS Rack for 11mm Tubes	20mm	252 x 125 x 30mm	£33.39
I2671-5013	50-Place Double SS Rack for Tall 13mm Tubes	20mm	207 x 108 x 60mm	£46.73
I2671-7814	78-Place Double SS Rack for 14mm Tubes	18mm	252 x 125 x 60mm	£52.29
I2671-5018	50-Place Double SS Rack for 18mm Tubes	23mm	252 x 125 x 80mm	£46.73
I2671-5020	50-Place Single SS Rack for 20mm Tubes	24mm	255 x 130 x 30mm	£40.11
I2671-2825	28-Place Double SS Rack for 25mm Tubes	35mm	252 x 145 x 80mm	£46.73
I2671-2830	28-Place Double SS Rack for 30mm Tubes	35mm	252 x 145 x 80mm	£46.73

### Examples of tubes suitable for use with the racks above:

- I2671-7211: Microcentrifuge Tubes, Screw Cap Microtubes
- I2671-5013: Taller Screw Cap Tubes, Cryovials, 12x75 FACS Tubes
- I2671-7814: Vacutainers (13mm)
- I2671-5018: 15ml Centrifuge Tubes, Culture Tubes, 12ml Tubes, Vacutainers (16mm)
- I2671-5020: 7.0ml Bijou Containers
- I2671-2825: 30ml Universal Tubes
- I2671-2830: 50ml Centrifuge Tubes

## Stainless steel petri dish racks

I2671-0057



I2671-0030

Petri dish racks with open or solid back. All racks have a card holder on the front and a fold-down carry handle. The two open racks are the same, except I2671-0060 is supplied with removable, stainless steel inserts which fit into each of the compartments to also enable the storage of 50mm/60mm dishes.

Stainless Steel Petri Dish Racks			
Cat. No.	Description	Ext. Dimensions (WxDxH)	Price
<b>Open Racks</b>			
I2671-0060	Petri Dish Rack for 30 x 100mm Ø Dishes or 60 x 50mm/60mm Ø Dishes	324 x 110 x 167mm	£70.25
I2671-0030	Petri Dish Rack for 30 x 100mm Ø Dishes	324 x 110 x 167mm	£45.57
<b>Solid Rack</b>			
I2671-0057	Petri Dish Rack for 57 x 100mm Ø Petri Dishes	324 x 110 x 314mm	£83.48

NOTE: Dish capacity per rack is based on 16.2mm high petri dishes.

## Stainless steel bins

Stainless steel bins offer an effective solution for storing a wide variety of samples. All bins have a lid, and a handle on the front. Can be used in -80°C freezers.



See also the bin racks on page 116.

Stainless Steel Bins			
Cat. No.*	Description	Ext. Dimensions (WxDxH)	Price
I2671-3911	139mm Wide Stainless Steel Bin with Lid (420 x 225)	139 x 420 x 225mm	£103.50
I2671-3912	139mm Wide Stainless Steel Bin with Lid (560 x 225)	139 x 560 x 225mm	£108.55
I2671-3913	139mm Wide Stainless Steel Bin with Lid (560 x 280)	139 x 560 x 280mm	£113.60
I2671-3914	139mm Wide Stainless Steel Bin with Lid (560 x 325)	139 x 560 x 325mm	£118.65
I2671-3915	139mm Wide Stainless Steel Bin with Lid (560 x 385)	139 x 560 x 385mm	£123.70
I2671-3916	139mm Wide Stainless Steel Bin with Lid (680 x 225)	139 x 680 x 225mm	£113.60
I2672-7811	278mm Wide Stainless Steel Bin with Lid (420 x 225)	278 x 420 x 225mm	£118.65
I2672-7812	278mm Wide Stainless Steel Bin with Lid (420 x 280)	278 x 420 x 280mm	£123.70
I2672-7813	278mm Wide Stainless Steel Bin with Lid (560 x 225)	278 x 560 x 225mm	£123.70
I2672-7814	278mm Wide Stainless Steel Bin with Lid (560 x 280)	278 x 560 x 280mm	£128.75
I2672-7815	278mm Wide Stainless Steel Bin with Lid (560 x 325)	278 x 560 x 325mm	£133.80
I2672-7816	278mm Wide Stainless Steel Bin with Lid (680 x 225)	278 x 680 x 225mm	£128.75

# Freezer Racking for Upright Freezers

## Stainless steel racking

Stainless steel provides the highest quality freezer racking. Stainless steel racks are available with side access or with pull-out shelves.

## New! Aluminium racking

Aluminium provides durable and light-weight racking at an economical price. Only racking with side access is available in aluminium.

## Measuring upright freezer racking

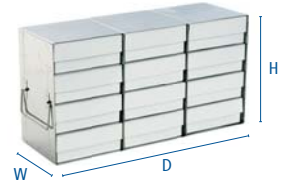

## Freezer racking for standard storage boxes up to 135 x 135 x 55mm

Suitable for use with:

- The 50mm high cardboard storage boxes, page 98
- The StarStore 130 x 130mm range of storage boxes, page 100
- The cryogenic storage boxes (except 25-place and 81-Place Tall), pages 103–104
- The expanding work rack on page 105
- StarRack 64, page 107
- Any storage box up to 135 x 135 x 55mm

I2602-3400  
Stainless steel rack  
with side access



I2612-4500  
Aluminium rack  
with side access

**New!**



### Stainless Steel Racks for Upright Freezers (130x130mm)

Cat. No.	Description	Boxes Deep	Boxes High	Rack Dimensions (WxDxH)	Price
I2602-3300	9-Place SS Rack	3	3	139 x 419 x 168 mm	£100.98
I2602-3400	12-Place SS Rack	3	4	139 x 419 x 221 mm	£103.50
I2602-3500	15-Place SS Rack	3	5	139 x 426 x 276 mm	£96.35
I2602-4300	12-Place SS Rack	4	3	139 x 558 x 168 mm	£103.50
I2602-4400	16-Place SS Rack	4	4	139 x 558 x 221 mm	£106.26
I2602-4500	20-Place SS Rack	4	5	139 x 558 x 276 mm	£108.55
I2602-4600	24-Place SS Rack	4	6	139 x 558 x 331 mm	£124.96
I2602-4700	28-Place SS Rack	4	7	139 x 558 x 386 mm	£130.01
I2602-5300	15-Place SS Rack	5	3	139 x 697 x 168 mm	£118.65
I2602-5400	20-Place SS Rack	5	4	139 x 697 x 221 mm	£122.44
I2602-5500	25-Place SS Rack	5	5	139 x 697 x 276 mm	£130.01
I2602-5600	30-Place SS Rack	5	6	139 x 697 x 331 mm	£135.06

### Aluminium Racks for Upright Freezers (130x130mm)

Cat. No.	Description	Boxes Deep	Boxes High	Rack Dimensions (WxDxH)	Price
I2612-3300	9-Place Aluminium Rack	3	3	139 x 419 x 168 mm	£85.83
I2612-3400	12-Place Aluminium Rack	3	4	139 x 419 x 221 mm	£88.36
I2612-3500	15-Place Aluminium Rack	3	5	139 x 426 x 276 mm	£90.88
I2612-4300	12-Place Aluminium Rack	4	3	139 x 558 x 168 mm	£88.36
I2612-4400	16-Place Aluminium Rack	4	4	139 x 558 x 221 mm	£90.88
I2612-4500	20-Place Aluminium Rack	4	5	139 x 558 x 276 mm	£92.14
I2612-4600	24-Place Aluminium Rack	4	6	139 x 558 x 331 mm	£106.03
I2612-4700	28-Place Aluminium Rack	4	7	139 x 558 x 386 mm	£111.08
I2612-5300	15-Place Aluminium Rack	5	3	139 x 697 x 168 mm	£100.98
I2612-5400	20-Place Aluminium Rack	5	4	139 x 697 x 221 mm	£103.50
I2612-5500	25-Place Aluminium Rack	5	5	139 x 697 x 276 mm	£111.08
I2612-5600	30-Place Aluminium Rack	5	6	139 x 697 x 331 mm	£114.86

# Freezer Racking for Upright Freezers

## Freezer racking for standard storage boxes up to 135 x 135 x 55mm (continued)

12632-4400  
Stainless steel rack  
with pull out shelves



Racks with pull out shelves  
have a 'stop' to prevent the  
shelves falling out

Stainless Steel Racks, Pull Out Shelves for Upright Freezers (130x130mm)					
Cat. No.	Description	Boxes Deep	Boxes High	Ext. Dimensions (WxDxH)	Price
12632-3300	9-Place SS Rack, Pull Out Shelves	3	3	140 x 421 x 171 mm	£171.25
12632-3400	12-Place SS Rack, Pull Out Shelves	3	4	140 x 421 x 228 mm	£174.19
12632-3500	15-Place SS Rack, Pull Out Shelves	3	5	140 x 421 x 285 mm	£186.81
12632-4300	12-Place SS Rack, Pull Out Shelves	4	3	140 x 558 x 171 mm	£171.67
12632-4400	16-Place SS Rack, Pull Out Shelves	4	4	140 x 558 x 228 mm	£176.72
12632-4500	20-Place SS Rack, Pull Out Shelves	4	5	140 x 558 x 285 mm	£186.81
12632-4600	24-Place SS Rack, Pull Out Shelves	4	6	140 x 558 x 340 mm	£196.91
12632-4700	28-Place SS Rack, Pull Out Shelves	4	7	140 x 558 x 398 mm	£207.01
12632-5300	15-Place SS Rack, Pull Out Shelves	5	3	140 x 696 x 171 mm	£186.81
12632-5400	20-Place SS Rack, Pull Out Shelves	5	4	140 x 696 x 228 mm	£196.91
12632-5500	25-Place SS Rack, Pull Out Shelves	5	5	140 x 696 x 285 mm	£207.01
12632-5600	30-Place SS Rack, Pull Out Shelves	5	6	140 x 696 x 340 mm	£217.11

### Freezer racking for other sizes of storage box

Freezer racking with side access or pull out shelves  
is also available for the 32mm, 75mm and 100mm  
high cardboard storage boxes on pages 98–99

Contact STARLAB for details



## Freezer racking for StarStore 100 storage boxes

Stainless steel racks for upright freezers for use with our most popular storage box, the StarStore 100, see page 101.

12610-1500  
Stainless steel rack  
with side access

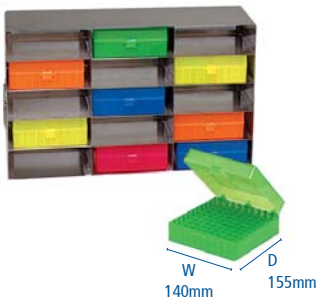

StarStore 100 storage boxes  
which fit inside this racking  
are available on page 101

Stainless Steel Racks for Upright Freezers (StarStore 100)					
Cat. No.	Description	Boxes Deep	Boxes High	Ext. Dimensions (WxDxH)	Price
12610-0800	8-Place SS Rack	2	4	160 x 300 x 240 mm	£111.30
12610-1200	12-Place SS Rack	3	4	160 x 452 x 240 mm	£133.56
12610-1500	15-Place SS Rack	3	5	160 x 452 x 300 mm	£159.13

Stainless Steel Racks, Pull Out Shelves for Upright Freezers (StarStore 100)					
Cat. No.	Description	Boxes Deep	Boxes High	Ext. Dimensions (WxDxH)	Price
12610-0920	9-Place SS Rack, Pull Out Shelves	3	3	165 x 450 x 187 mm	£166.95
12610-1220	12-Place SS Rack, Pull Out Shelves	3	4	165 x 450 x 248 mm	£200.34
12610-1620	16-Place SS Rack, Pull Out Shelves	4	4	165 x 596 x 248 mm	£222.60

NOTE: StarStore 100 boxes sit sideways on the shelves in the racking above (hinge to the side).

Stainless Steel Racks, Pull Out Shelves for Upright Freezers (StarStore 100)					
Cat. No.	Description	Boxes Deep	Boxes High	Ext. Dimensions (WxDxH)	Price
12611-1200	12-Place SS Rack, Shallow Pull Out Shelves	3	4	155 x 559 x 235 mm	£132.00
12611-1500	15-Place SS Rack, Shallow Pull Out Shelves	3	5	155 x 559 x 294 mm	£150.00
12611-1600	16-Place SS Rack, Shallow Pull Out Shelves	4	4	155 x 673 x 235 mm	£150.00
12611-2000	20-Place SS Rack, Shallow Pull Out Shelves	4	5	155 x 673 x 300 mm	£175.00
12611-2100	21-Place SS Rack, Shallow Pull Out Shelves	3	7	155 x 559 x 410 mm	£195.00
12611-2400	24-Place SS Rack, Shallow Pull Out Shelves	4	6	155 x 673 x 360 mm	£210.00

NOTE: StarStore 100 boxes sit forwards on the shelves in the racking above (hinge to the back).

## Freezer Racking for Upright Freezers

### Stainless steel bin racking

Versatile storage for upright freezers comprising a rack with two bin-style drawers with a lid.



### Freezer racking for 1.5/2.0ml tubes

These racks have pull out trays which contain polypropylene dividers for the direct storage of tubes up to 12.5mm diameter, eg. 1.5/2.0ml microcentrifuge or screw cap tubes.

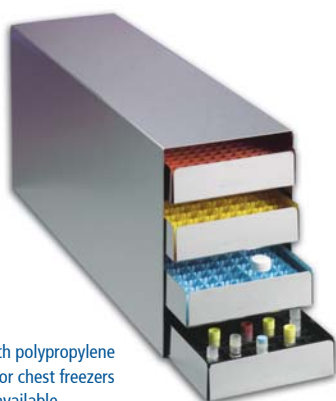

Racks with polypropylene dividers for chest freezers are also available. Contact STARLAB for details.

### Freezer racking for 15ml & 50ml centrifuge tubes



I2615-5000

Stainless Steel Bin Racks for Upright Freezers			
Cat. No.	Description	Rack Dimensions (WxDxH)	Price
I2671-3921	139mm Wide 2-Bin Stainless Steel Rack (420 x 225)	139 x 420 x 225mm	£174.19
I2671-3922	139mm Wide 2-Bin Stainless Steel Rack (560 x 225)	139 x 560 x 225mm	£184.29
I2671-3923	139mm Wide 2-Bin Stainless Steel Rack (560 x 280)	139 x 560 x 280mm	£196.91
I2671-3924	139mm Wide 2-Bin Stainless Steel Rack (560 x 385)	139 x 560 x 385mm	£217.11
I2671-3925	139mm Wide 2-Bin Stainless Steel Rack (680 x 280)	139 x 680 x 280mm	£204.48
I2672-7821	278mm Wide 2-Bin Stainless Steel Rack (420 x 225)	278 x 420 x 225mm	£220.89
I2672-7822	278mm Wide 2-Bin Stainless Steel Rack (560 x 225)	278 x 560 x 225mm	£233.52
I2672-7823	278mm Wide 2-Bin Stainless Steel Rack (560 x 280)	278 x 560 x 280mm	£233.52
I2672-7824	278mm Wide 2-Bin Stainless Steel Rack (560 x 385)	278 x 560 x 385mm	£271.38
I2672-7825	278mm Wide 2-Bin Stainless Steel Rack (680 x 280)	278 x 680 x 280mm	£258.76

Stainless Steel Racks for Upright Freezers (1.5/2.0ml Tubes)						
Cat. No.	Description	Trays High	Tubes per Rack	Max. Tube Height	Ext. Dimensions (WxDxH)	Price
I2670-1680	4-Tray SS Rack	4	1680	57mm	140 x 556 x 235mm	£234.15
I2670-2100	5-Tray SS Rack	5	2100	54mm	140 x 556 x 280mm	£275.73
I2670-2940	7-Tray SS Rack	7	2940	57mm	140 x 556 x 410mm	£373.17
I2670-1848	4-Tray SS Rack	4	1848	57mm	160 x 556 x 235mm	£246.96
I2670-2310	5-Tray SS Rack	5	2310	54mm	160 x 556 x 280mm	£291.06
I2670-3234	7-Tray SS Rack	7	3234	57mm	160 x 556 x 410mm	£393.65
I2670-1760	4-Tray SS Rack	4	1760	57mm	140 x 595 x 235mm	£238.67
I2670-2200	5-Tray SS Rack	5	2200	54mm	140 x 595 x 280mm	£281.61
I2670-3080	7-Tray SS Rack	7	3080	57mm	140 x 595 x 410mm	£378.21
I2670-1936	4-Tray SS Rack	4	1936	57mm	160 x 595 x 235mm	£254.21
I2670-2420	5-Tray SS Rack	5	2420	54mm	160 x 595 x 280mm	£300.72
I2670-3388	7-Tray SS Rack	7	3388	57mm	160 x 595 x 410mm	£404.04

IMPORTANT NOTE: The image on the left is for illustrative purposes only. All racks will be supplied with the same colour divider in each tray. Although the colour of dividers supplied may not be able to be guaranteed, please state your colour of choice when ordering – choose from: blue, green, red, orange, violet, yellow, white or black.

Stainless Steel (SS) racks for upright freezers, for the direct storage of 15ml or 50ml centrifuge tubes. Saves you the time of transferring the tubes to/from storage boxes.

Stainless Steel Racks for Upright Freezers (15ml & 50ml Tubes)				
Cat. No.	Description	Drawers	Ext. Dimensions (WxDxH)	Price
I2615-1000	60-Place SS Rack for 15ml Tubes	1	140 x 419 x 126mm	£100.17
I2615-3600	120-Place SS Rack for 15ml Tubes	2	140 x 419 x 252mm	£166.95
I2615-2600	160-Place SS Rack for 15ml Tubes	2	140 x 559 x 252mm	£183.65
I2650-3600	60-Place SS Rack for 50ml Tubes	2	140 x 419 x 252mm	£166.95
I2650-2600	78-Place SS Rack for 50ml Tubes	2	140 x 559 x 252mm	£183.65
I2615-5000	Combination SS Rack for 80 x 15ml and 39 x 50ml Tubes	2	140 x 559 x 252mm	£150.26

# Freezer Racking for Upright Freezers

## Freezer racking for plates



Plates can either be stored one plate per shelf or they can be stacked. For example, a rack with the shelf height of 45mm can be used to store one deepwell plate per shelf, or 4 x 10mm high plates

Stainless Steel (SS) and aluminium racks for upright freezers, ideal for storing a variety of plates. Plates can either be stored one to a shelf or stacked one on top of the other in deeper shelves.

Stainless Steel Racks for Upright Freezers (Plates)					
Cat. No.	Description	Shelf Height	Plates (DxH)	Rack Dimensions (WxDxH)	Price
I2652-4500	45-Place SS Rack for Low-Profile Plates	16mm	5 x 9	135 x 450 x 153 mm	£220.89
I2652-7800	78-Place SS Rack for Low-Profile Plates	16mm	6 x 13	135 x 540 x 221 mm	£239.83
I2652-1120	112-Place SS Rack for Low-Profile Plates	16mm	7 x 16	135 x 630 x 272 mm	£265.07
I2652-3000	30-Place SS Rack for Microplates	25mm	5 x 6	135 x 450 x 159 mm	£181.76
I2652-2000	20-Place SS Rack for Deepwell Plates	45mm	5 x 4	135 x 450 x 186 mm	£143.90

## New!

Aluminium Racks for Upright Freezers (Plates)					
Cat. No.	Description	Shelf Height	Plates (DxH)	Rack Dimensions (WxDxH)	Price
I2662-4500	45-Place Aluminium Rack for Low-Profile Plates	16mm	5 x 9	135 x 450 x 153mm	£176.72
I2662-7800	78-Place Aluminium Rack for Low-Profile Plates	16mm	6 x 13	135 x 540 x 221mm	£191.86
I2662-1120	112-Place Aluminium Rack for Low-Profile Plates	16mm	7 x 16	135 x 540 x 221mm	£212.06
I2662-3000	30-Place Aluminium Rack for Microplates	25mm	5 x 6	135 x 630 x 272mm	£145.16
I2662-2000	20-Place Aluminium Rack for Deepwell Plates	45mm	5 x 4	135 x 450 x 186mm	£114.86

## New!

Stainless Steel Racks, Pull Out Shelves for Upright Freezers (Plates)					
Cat. No.	Description	Shelf Height	Plates (DxH)	Ext. Dimensions (WxDxH)	Price
I2653-4500	45-Place SS Rack for Low-Profile Plates, Pull Out Shelves	16mm	5 x 9	135 x 450 x 153 mm	£397.61
I2653-7800	78-Place SS Rack for Low-Profile Plates, Pull Out Shelves	16mm	6 x 13	135 x 540 x 221 mm	£435.48
I2653-1120	112-Place SS Rack for Low-Profile Plates, Pull Out Shelves	16mm	7 x 16	135 x 630 x 272 mm	£479.66
I2653-3000	30-Place SS Rack for Microplates, Pull Out Shelves	25mm	5 x 6	135 x 450 x 159 mm	£309.25
I2653-2000	20-Place SS Rack for Deepwell Plates, Pull Out Shelves	45mm	5 x 4	135 x 450 x 186mm	£227.21



Racks with pull out shelves have a 'stop' to prevent the shelves falling out.

## Other sizes of freezer racking available!

The freezer racking shown in this catalogue is just a selection of those available. Contact STARLAB with the make and model of your freezer and the type of storage box or plate you wish to store.

# Freezer Racking for Chest Freezers

## Stainless steel racking

Stainless steel provides the highest quality freezer racking.

## *New!* Aluminium racking

Aluminium provides durable and light-weight racking at an economical price.

## Measuring chest freezer racking



## Freezer racking for standard storage boxes up to 135 x 135 x 55mm

Suitable for use with:

- The 50mm high cardboard storage boxes, page 98
- The StarStore 130 x 130mm range of storage boxes, page 100
- The cryogenic storage boxes (except 25-place and 81-Place Tall), pages 103–104
- The expanding work rack, page 105
- StarRack 64, page 107
- Any storage box up to 135 x 135 x 55mm

### Stainless Steel Racks for Chest Freezers (130x130mm)

Cat. No.	Description	Ext. Dimensions (WxDxH)	Price
I2602-3000	3-High SS Rack	140 x 140 x 170 mm	£71.95
I2602-5000	5-High SS Rack	140 x 140 x 280 mm	£74.47
I2602-6000	6-High SS Rack	140 x 140 x 335 mm	£75.74
I2602-7000	7-High SS Rack	140 x 140 x 390 mm	£79.52
I2602-8000	8-High SS Rack	140 x 140 x 445 mm	£82.05
I2602-9000	9-High SS Rack	140 x 140 x 500 mm	£83.31
I2602-1000	10-High SS Rack	140 x 140 x 555 mm	£84.57
I2602-1100	11-High SS Rack	140 x 140 x 610 mm	£85.83
I2602-1200	12-High SS Rack	140 x 140 x 665 mm	£87.10
I2602-1300	13-High SS Rack	140 x 140 x 720 mm	£89.85

I2602-6000

Stainless steel racking with locking rod to hold boxes in place



*New!*

Stainless steel racking with spring lock to hold boxes in place



### Stainless Steel Spring Lock Racks for Chest Freezers (130x130mm)

Cat. No.	Description	Ext. Dimensions (WxDxH)	Price
I2613-3000	3-High SS Rack, Spring Lock	140 x 140 x 170 mm	£78.26
I2613-5000	5-High SS Rack, Spring Lock	140 x 140 x 280 mm	£82.05
I2613-6000	6-High SS Rack, Spring Lock	140 x 140 x 335 mm	£84.57
I2613-7000	7-High SS Rack, Spring Lock	140 x 140 x 390 mm	£87.10
I2613-8000	8-High SS Rack, Spring Lock	140 x 140 x 445 mm	£92.14
I2613-9000	9-High SS Rack, Spring Lock	140 x 140 x 500 mm	£10.52
I2613-1000	10-High SS Rack, Spring Lock	140 x 140 x 555 mm	£97.19
I2613-1100	11-High SS Rack, Spring Lock	140 x 140 x 610 mm	£100.98
I2613-1200	12-High SS Rack, Spring Lock	140 x 140 x 665 mm	£104.77
I2613-1300	13-High SS Rack, Spring Lock	140 x 140 x 720 mm	£107.29

*New!*

### Aluminium Racks for Chest Freezers (130x130mm)

Cat. No.	Description	Ext. Dimensions (WxDxH)	Price
I2612-3000	3-High Aluminium Rack	140 x 140 x 170 mm	£61.85
I2612-5000	5-High Aluminium Rack	140 x 140 x 280 mm	£63.11
I2612-6000	6-High Aluminium Rack	140 x 140 x 335 mm	£64.37
I2612-7000	7-High Aluminium Rack	140 x 140 x 390 mm	£66.90
I2612-8000	8-High Aluminium Rack	140 x 140 x 445 mm	£69.42
I2612-9000	9-High Aluminium Rack	140 x 140 x 500 mm	£70.69
I2612-1000	10-High Aluminium Rack	140 x 140 x 555 mm	£71.95
I2612-1100	11-High Aluminium Rack	140 x 140 x 610 mm	£73.21
I2612-1200	12-High Aluminium Rack	140 x 140 x 665 mm	£74.47
I2612-1300	13-High Aluminium Rack	140 x 140 x 720 mm	£77.00

I2612-1100





# Freezer Racking for Chest Freezers

## Freezer racking for StarStore 100 storage boxes



Stainless steel racking, suitable for use in for chest freezers with our most popular storage box, the StarStore 100 (see page 101). Locking bar secures boxes in place.

Stainless Steel Racks for Chest Freezers (StarStore 100)			
Cat. No.	Description	Ext. Dimensions (WxDxH)	Price
I2610-1800	8-High SS Rack for StarStore 100	147 x 159 x 479mm	£94.61
I2610-1900	9-High SS Rack for StarStore 100	147 x 159 x 538mm	£100.17
I2610-2000	10-High SS Rack for StarStore 100	147 x 159 x 596mm	£105.74
I2610-2100	11-High SS Rack for StarStore 100	147 x 159 x 655mm	£111.30
I2610-2200	12-High SS Rack for StarStore 100	147 x 159 x 714mm	£116.87

## Freezer and liquid nitrogen racking for cryogenic storage boxes



Stainless steel racking, suitable for use in chest freezers with the 25-place or 81-place tall cryogenic storage boxes on page 103. Racking can be used in the freezer or submerged in liquid nitrogen.

Stainless Steel Racks for Chest Freezers (25-Place Cryo)			
Cat. No.	Description	Ext. Dimensions (WxDxH)	Price
I2602-1325	13-High SS Rack for 25-Place Cryogenic Storage Box	82 x 86 x 750mm	£105.74

Stainless Steel Racks for Chest Freezers (81-Place Tall Cryo)			
Cat. No.	Description	Ext. Dimensions (WxDxH)	Price
I2602-3081	3-High SS Rack for 81-Place Tall Cryogenic Storage Box	140 x 140 x 320mm	£75.74
I2602-4081	4-High SS Rack for 81-Place Tall Cryogenic Storage Box	140 x 140 x 425mm	£79.52
I2602-5081	5-High SS Rack for 81-Place Tall Cryogenic Storage Box	140 x 140 x 530mm	£84.57
I2602-6081	6-High SS Rack for 81-Place Tall Cryogenic Storage Box	140 x 140 x 635mm	£88.36

Stainless steel racking with locking rod to hold boxes in place

## Custom-Made Freezer Racking

We can manufacture any rack you may require for your upright or chest freezer. For custom designed racking, we need to have the exact overall dimensions of the boxes, plates or tubes which are to be used in the racking, plus the brand and model of the freezer in which the racking will be used.

Customised racking allows you optimise the space in your freezer when you have:

- standard size storage boxes but the racking offered does not fit well in your freezer
- smaller or larger storage boxes to the standard and you require racking to fit those boxes
- plates or racked tubes of a non-standard height that will not fit the shelf heights already offered

Contact STARLAB with your requirements and we will provide you with a competitive quote!



# Slide Storage Cabinets

**New!**

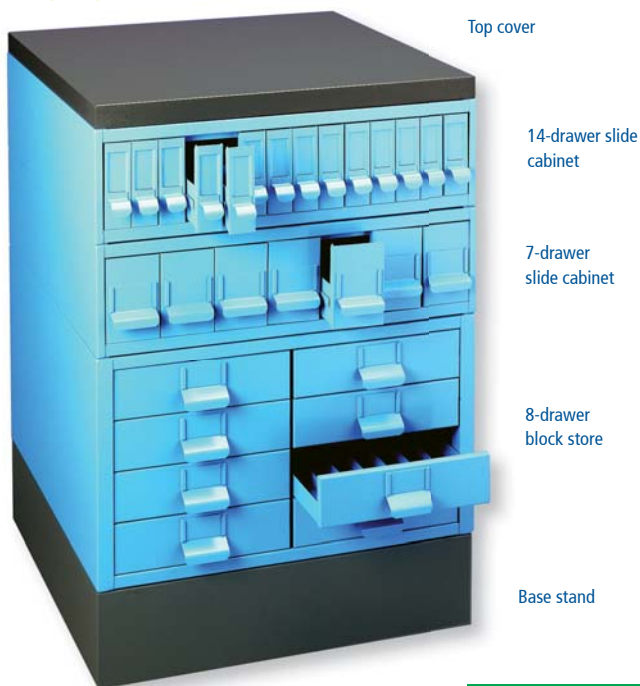

## Versatile, stackable slide cabinets

A range of powder-coated zintec steel cabinets with the same 480 x 480mm footprint. The cabinets can be used alone or stacked one on top of the other in order to make one cabinet with the components of your choice.

- **14-drawer slide cabinet**

Holds approximately 600 (76 x 26mm) microscope slides  
Height: 140mm

- **7-drawer cabinet**

Holds larger (76 x 50mm) slides or larger wax blocks  
Height: 140mm

- **8-drawer block store**

Holds blocks and cassettes (approx. 3000)  
Each drawer has seven rows of 30mm width sections  
Height: 280mm

Slide Storage Cabinets				
Cat. No.	Description	Colours Available	Pack Size	Price
E1500-10##	Top Cover for Slide Storage Cabinets	Blue, Green, Black	1	£60.00
E1500-11##	14-Drawer Slide Cabinet	Blue, Green	1	£290.00
E1500-12##	7-Drawer Slide Cabinet	Blue, Green	1	£270.00
E1500-13##	8-Drawer Block Store	Blue, Green	1	£345.00
E1500-1408	Base Stand	Black	1	£75.00

To order colour required, replace ## as last digits of Cat. No. with: 01 for Blue, 02 for Green, 08 for Black. See ordering table for colour availability.

# Slide Storage Trays

Cardboard Slide Storage Tray					
	Description	Capacity	Cat. No.	Pack Size	Price
	<b>Cardboard slide storage tray</b> Cardboard trays with horizontal, numbered recesses to protect your slide specimens with the tray cover is closed. Thumb cuts for easy slide removal. Index writing panel on the front.  Dimensions (WxDxH): 20-Place: 208 x 341 x 9mm. 30-Place: 281 x 328 x 10mm	20 Slides	E1500-2009	10	£25.62
		30 Slides	E1500-3009	10	£44.52

## Slide Storage Trays

StarFolder Slide Storage Tray					
	Description	Colour	Cat. No.	Pack Size	Price
	<b>StarFolder slide storage tray</b> Holds 20 standard slides in numbered, horizontal slots. Transparent doors cover the slides while still allow visual access and barcode reading. The doors can be swung round the back of the folder completely out of the way if required. Temperature use: -80°C to 80°C. (Not Autoclavable). Dimensions (WxDxH): 192 x 292 x 11mm.	Blue	E1500-0031	10	£73.50
		Green	E1500-0032	10	£73.50
		Yellow	E1500-0036	10	£73.50
		Grey	E1500-0038	10	£73.50
		White	E1500-0039	10	£73.50
		Mixed*	E1500-0099	10	£73.50

\*Mixed pack contains two of each colour.

## Slide Storage Boxes



### StarFile storage system

Stackable slide storage filing system, comprising slide box with a transparent, hinged lid and a removable draining rack. Made from impact resistant acetal polymer, the StarFile stores slides vertically for easy insertion and removal. Slides can be tilted forward/back for easy selection, or for the reading of barcodes without having to remove the slides. Each box is supplied with two index cards. Temperature use: -80°C to 80°C. Available in two sizes:

Slide Storage Boxes					
Cat. No.	Description	Colour	Pack Size	Price	
<b>StarFile</b>					
E1500-0011	StarFile Slide Box with Drain Rack	Blue	10	£72.35	
E1500-0012	StarFile Slide Box with Drain Rack	Green	10	£72.35	
E1500-0014	StarFile Slide Box with Drain Rack	Pink	10	£72.35	
E1500-0016	StarFile Slide Box with Drain Rack	Yellow	10	£72.35	
E1500-0019	StarFile Slide Box with Drain Rack	White	10	£72.35	
<b>StarFile Jr</b>					
E1500-0021	StarFile Jr Slide Box with Drain Rack	Blue	10	£53.45	
E1500-0022	StarFile Jr Slide Box with Drain Rack	Green	10	£53.45	
E1500-0024	StarFile Jr Slide Box with Drain Rack	Pink	10	£53.45	
E1500-0026	StarFile Jr Slide Box with Drain Rack	Yellow	10	£53.45	
E1500-0029	StarFile Jr Slide Box with Drain Rack	White	10	£53.45	

Dimensions (WxDxH): StarFile: 82 x 245 x 86mm (Drain Rack: 75 x 231 x 25mm).  
 StarFile Jr: 82 x 140 x 86mm (Drain Rack: 75 x 125 x 25mm). NOTE: These storage boxes are not autoclavable.

**StarFile:** Slide storage box with removable drain rack tray with 100 numbered slots. Stores slides vertically. Slots can hold two slides if required, or 400 slides can be stored in three rows in the box if the drain rack is removed.

**StarFile Jr:** Slide storage box with removable drain rack tray with 50 numbered slots. Stores slides vertically. Slots can hold two slides if required, or 200 slides can be stored in three rows in the box if the drain rack is removed.

## Slide Staining

### StarStain slide staining system

The StarStain slide staining system comprises two units available separately: slide staining jars and slide draining racks. A slide staining kit is also available.



### Slide staining jars

- Connect side by side to ensure they are kept in the same order
- Made from acetal plastic which resists most staining agents, including alcohol and xylene (but not phenol)
- Wide base for benchtop stability
- Internal recess for a smaller, more economical reagent volume (80ml)
- Temperature use: -170°C to 121°C
- Autoclavable

### Slide staining racks

- Rapid draining for up to 12 slides
- Slides are placed vertically – no staining of the writing area!
- Handle for easy insertion/removal into the Staining Jar, without fingers touching the solution
- Temperature use: -170°C to 121°C
- Autoclavable



Slide Staining				
Cat. No.	Description	Colour	Pack Size	Price
E1500-0041	StarStain Slide Staining Jar	Blue	6	£57.86
E1500-0042	StarStain Slide Staining Jar	Green	6	£57.86
E1500-0044	StarStain Slide Staining Jar	Pink	6	£57.86
E1500-0046	StarStain Slide Staining Jar	Yellow	6	£57.86
E1500-0049	StarStain Slide Staining Jar	White	6	£57.86
E1500-0058	StarStain Staining Rack	Grey	6	£63.42
E1500-0048	StarStain Slide Staining Kit Comprises: 5 x Slide Staining Jars, 1 x Staining Rack	Various	6	£61.22

## Slide Mailers

### Polypropylene slide mailers for standard (75 x 25mm) slides

#### Holds 5 slides

Internal slotted channels keep slides separated



#### Holds 2 slides

Internal recess keeps slides secure



### End-Opening Slide Mailers

Cat. No.	Description	Colour	Pack Size	Price
E1500-4000	End-Opening Slide Mailer	Natural	25	£13.34
E1500-4099	End-Opening Slide Mailer	Mixed*	25	£13.34

\*Mixed pack contains five each of: Blue, Orange, Red, Violet, Yellow. Dimensions (WxDxH): 43 x 88 x 24mm.

### 2-Place Slide Mailers

Cat. No.	Description	Colour	Pack Size	Price
E1400-2099	2-Place Slide Mailer	Mixed*	25	£12.60

\*Mixed pack contains five each of: Blue, Orange, Red, Violet, Yellow. Dimensions (WxDxH): 68 x 93 x 5mm.



# *Equipment*

## **PCR CABINETS**

AirClean® PCR Cabinets..... 124–125

## **MAGNETIC STIRRERS**

Ultra Flat Magnetic Stirrer ..... 126

Magnetic Stirrer with Heater ..... 126

## **ORBITAL SHAKER**

Digital Orbital Shaker ..... 127

## **DRY BATH INCUBATORS**

Single & Dual Block Systems ..... 128

## **VORTEX MIXERS**

Vortex Wizard with Infra-Red ..... 129

STARLAB Vortex..... 130

## **MICROCENTRIFUGES**

Plate Centrifuge ..... 131

MiniFuge ..... 132

# AirClean® PCR Cabinets

## Minimise cross-contamination!

AirClean® Systems PCR Workstations are designed as application solutions for the manipulation and amplification of DNA and RNA. Cross-contamination during amplification of DNA and RNA can lead to results that are inaccurate — results that cost you your valuable time and consume expensive reagents!

AirClean® Systems PCR Workstations offer a controlled environment for PCR applications to improve the odds for getting accurate results.

### Dead Air Cabinets

Provides a circulation-free environment with UV light sterilisation.

### Laminar Flow Cabinets

Combines a Class 100 (ISO 5) vertical laminar flow environment with UV light sterilisation.

Both types of cabinet are available in two sizes, and incorporate the following features:

- UVTect™ microprocessor
- Polycarbonate design to reflect UV energy. Polycarbonate does not break down under UV like acrylic cabinets
- Folding sash for full and easy access
- Fluorescent light
- UV light
- Safety interlock switch that automatically cuts off the UV light when the sash is opened
- One piece plastic construction ensures no UV energy escapes during sterilisation
- PCR Cabinets are supplied ready-assembled – just plug and play!

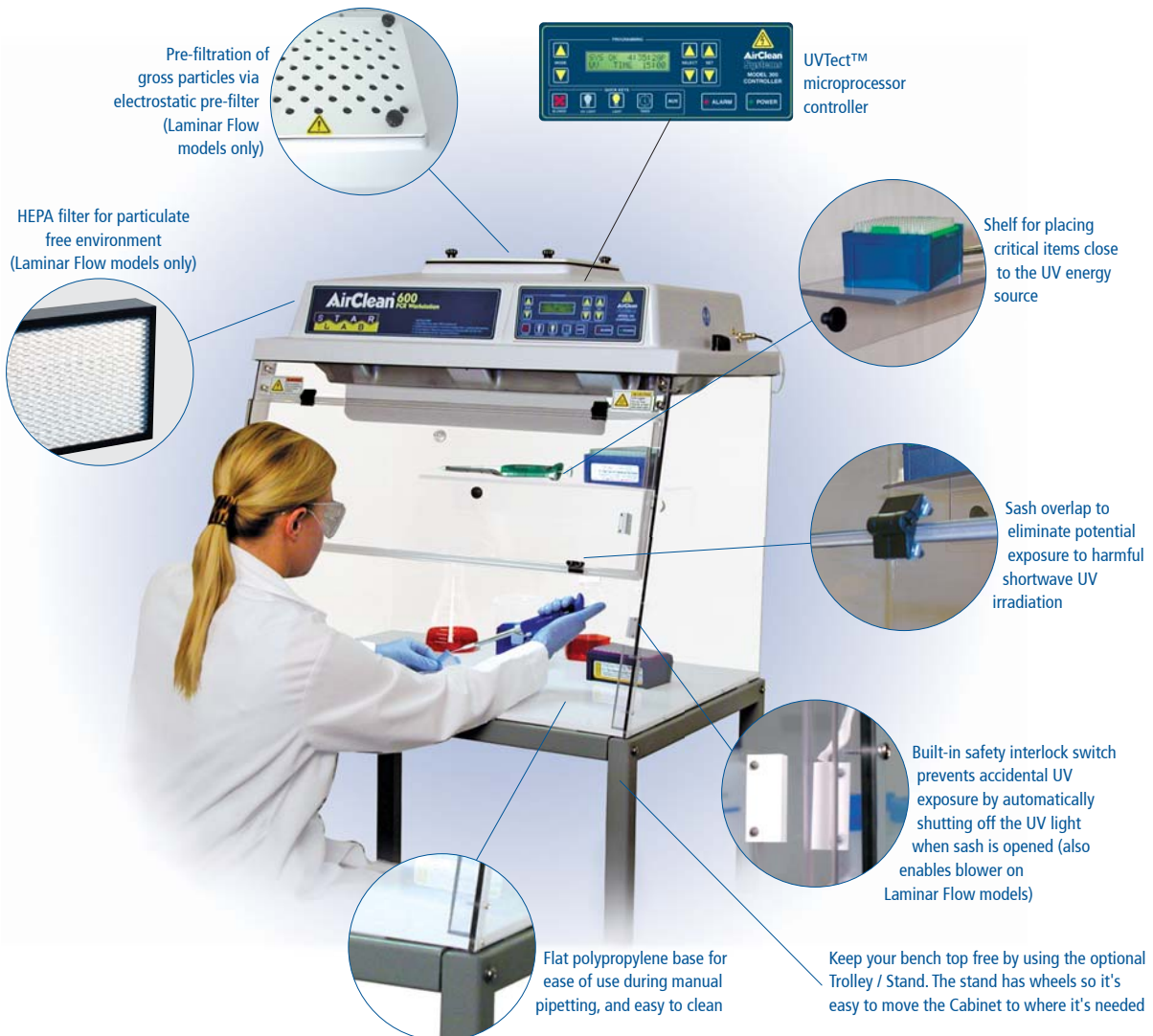

# AirClean® PCR Cabinets



## What does the UVTect™ do?

- Time and date display
- Digital UV timer
- Lab event timer
- UV bulb monitor to check the effectiveness of the bulb, and alert you when bulb life is getting low
- HEPA filter monitor to alert you when the filter needs changing (Laminar Flow models only)
- Variable speed blower control allows manual adjustment to the airflow to accommodate even the most fragile of samples (Laminar Flow models only)

## How the "Laminar Flow" works

- Room air enters at **A**
- The air is forced through the HEPA filter to create a laminar flow
- Clean, laminar flow air enters at **B**, and exits at **C**
- UV light sterilises pipettes, pipette tips, tubes and flasks

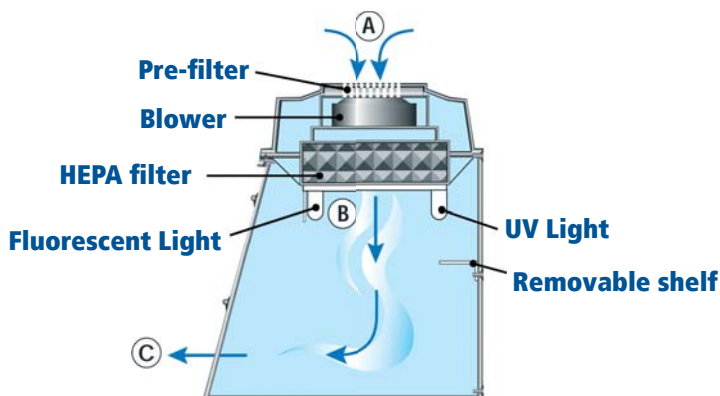

	Dead Air Cabinets		Class 100 Laminar Flow Cabinets	
	32" Cabinet	48" Cabinet	32" Cabinet	48" Cabinet
<b>Features and Specifications</b>				
UVTect Controller	✓	✓	✓	✓
Lab Event Timer	✓	✓	✓	✓
Pre-Filter	✗	✗	✓	✓
HEPA Filter	✗	✗	✓	✓
HEPA Filter Life Monitor	✗	✗	✓	✓
Variable Speed Blow Control	✗	✗	✓	✓
Fluorescent Bulb	✓	✓	✓	✓
UV Bulb	x 1	x 2	x 1	x 2
UV Light Timer	0 – 60 mins (digital)	0 – 60 mins (digital)	0 – 60 mins (digital)	0 – 60 mins (digital)
UV Bulb Life Monitor	✓	✓	✓	✓
UV Safety Interlock Switch	✓	✓	✓	✓
Ext. Dimensions (wxdxh)	825 x 616 x 775mm	1239 x 622 x 787mm	825 x 616 x 775mm	1239 x 622 x 787mm
Ship Weight (approx)	46kg	68 kg	57kg	82kg
Noise Level	n/a	n/a	<49 dba	<53 dba
Voltage	110V or 220V	110V or 220V	110V or 220V	110V or 220V
UV Light	15W, 254nm	2 x 15W, 254nm	15W, 254nm	2 x 15W, 254nm
Air Velocity	n/a	n/a	Digital	Digital
<b>Cabinet Ordering Info</b>				
PCR Cabinets	N2540-8400 £1869.84	N2540-8500 £2863.77	N2530-8200 £2781.35	N2530-8300 £3763.10
<b>Accessories Ordering Info</b>				
Pre Filters (Pack of 10)	n/a	n/a	N3942-7500 £166.95	N3952-7518 £200.34
HEPA Filters (Each)	n/a	n/a	N3942-7000 £255.99	N3952-7018* £222.60
UV Bulbs (Pack of 4)	N2530-1500 £189.21	N2530-1500 £189.21	N2530-1500 £189.21	N2530-1500 £189.21
Trolley / Stand	N2520-3200 £559.86	N2520-4800 £667.80	N2520-3200 £559.86	N2520-4800 £667.80

\*2 required



## Ultra Flat Magnetic Stirrer



### Features

- Microprocessor controlled
- Gentle start-up offers optimum progression of the stirring speed
- Maintenance free
- Made from chemically resistant materials

### Ultra flat, ultra modern!

The ultra flat magnetic stirrer has no moving mechanical components, so it's maintenance free!

The stirring system, adjustable by means of a microprocessor, is made up of coils that induce a rotating magnetic field. The modern, ergonomic structure is made of materials that guarantee high resistance to the aggression of chemical reagents.

### Specifications

Stirring Speed	Up to 1100 rpm
Stirring Volume	Up to 5 l (H <sub>2</sub> O)
Operating Temperature	-10°C – 60°C
Unit Material	Technopolymer
Power	5W
Power Supply	100V – 240V , 50 – 60Hz
Weight	0.9kg
Dimensions	160 x 230 x 33mm

### Ultra Flat Magnetic Stirrer

Cat. No.	Description	Pack Size	Price
N2400-2000	Magnetic Stirrer, ESP, Ultra Flat	1	£175.88

## Magnetic Stirrer with Heater



### Features

- Electronic speed control
- Even heat distribution
- Made from chemically resistant materials

### Stir up some heat!

The magnetic stirrer with heating is equipped with an advanced, electronic speed control.

The stirrer's heating plate is made of aluminium alloy and has a special protective coating that ensures an even heat distribution across the entire surface, as well as providing excellent chemical resistance.

### Specifications

Stirring Speed	Up to 1200 rpm
Stirring Volume	Up to 15 litres (H <sub>2</sub> O)
Stirring System	High-power driving magnet type 'PCM' operated by monophase motor for continuous operation
Programmable Temp. Range	50 – 370°C
Temperature Regulation	Room temp. to 370°C
Unit Material	Epoxy painted aluminium
Power	630W
Power Supply	230V / 50 Hz
Weight	2.9kg
Heating Plate	155mm Ø
Dimensions	165 x 280 x 115mm

### Magnetic Stirrer with Heater

Cat. No.	Description	Pack Size	Price
N2400-3000	Magnetic Stirrer with Heater	1	£280.46



# Digital Orbital Shaker



## Shake it all about!

The STARLAB digital orbital shaker tracks timed runs, continuous usage and rpm settings for improved test procedure repeatability. The non-stop optical motor feedback provides instantaneous speed adjustment – turn the speed knob for gentle agitation or vigorous orbital motion. The slow start motion decreases the risk of spills. Low speeds provide gentle shaking for molecular biology and immunology applications.

## Features

- Skid-free rubber mat with unique wave design
- Sturdy anodised aluminium platform
- Supplied with elastic ties (bungee cords) to stabilise flasks and beakers
- Optical motor feedback
- Soft rubber feet to minimise 'walking' during use
- Timer can be set to continuous, or up to 49 hours and 23 minutes
- Instant speed adjustment, from 20 to 300 rpm
- LCD shows speed and time remaining
- Audible beep indicates ending time



Specifications	
Display	LCD
Speed	20 – 300 rpm
Orbit Diameter	19mm
Platform Size:	28 x 28mm
Maximum Load	4.5kg
Timer	0 – 49 hours and 23 minutes, or continuous
Operating Temp.	4°C – 40°C
Unit Material	Anodised Aluminium
Voltage	100V or 220V AC, 50/60 Hz
Dimensions	31.5 x 18 x 30mm



Digital Orbital Shaker			
Cat. No.	Description	Pack Size	Price
N2400-7000	STARLAB Digital Orbital Shaker*	1	£550.94
Accessories			
N2400-7001	Replacement Rubber Mat	1	£36.75
N2400-7002	Replacement Bungee Cords	8	£36.75
N2400-7003	Replacement Universal Power Adaptor	1	£36.75

\*Supplied with a power adaptor and eight bungee cords.



# Dry Bath Heating Systems



N2400-4002  
(with 2 x N2400-4101)

## Dry bath, wet bath!

Designed for a wide variety of applications, including restriction digests, denaturing DNA, NUB, melting agar, coagulation studies, in-situ hybridisation, and Hot Start thermocycler reactions, as well as having the additional function of a water bath.

## Features

- Microprocessor controlled timer and temperature
- Digital display
- Easy, user calibration
- Can also be used as a waterbath
- 2-year warranty

Specifications	
Controller	Digital microprocessor
Display	Digital
Operating Temp	5°C above ambient to 150°C
Temp. Increase	0.1°C
Temp. Calibration	Yes
Temp. Uniformity	±0.2°C
Temp. Accuracy	±0.2°C
Timer	0 – 999 minutes
Safety Device	Leak-proof heating chamber
Heating Chamber Material	Teflon-coated aluminium
Block Material	Aluminium
Block Dimensions	80 x 105 x 50mm (except N2400-4108)
Water Bath Volume	400ml (single) / 800ml (dual)
Voltage	110 V or 220 V
Weight	2.6kg (single) / 2.8kg (dual)
Dimensions	200 x 270 x 80mm



N2400-4001  
(with N2400-4103)



N2400-4002  
as a waterbath

Dry Bath Heating Systems			
Cat. No.	Description	Pack Size	Price
N2400-4001	Dry Bath Heating System, Single Block, Digital*	1	£266.70
N2400-4002	Dry Bath Heating System, Dual Block, Digital*	1	£405.30

\* Metal blocks are not included and must be purchased separately, see below.

## Metal Blocks



For 64 x 0.2ml  
PCR Tubes

Cat. No: N2400-4100  
£72.77 each



For 20 x 1.5/2.0ml  
Microcentrifuge Tubes

Cat. No: N2400-4101  
£72.77 each



For 12 x 15ml  
Centrifuge Tubes

Cat. No: N2400-4102  
£72.77 each



For 4 x 50ml  
Centrifuge Tubes

Cat. No: N2400-4103  
£72.77 each



All metal blocks are supplied with a screw-in handle for easy insertion and removal



For 20 x 1.5/2.0ml Microcentrifuge Tubes (V-Bottoms)

Cat. No: N2400-4104  
£72.77 each



For 20 x 0.5ml PCR or Microcentrifuge Tubes

Cat. No: N2400-4105  
£72.77 each



For 20 x 13mm  
Tubes

Cat. No: N2400-4106  
£72.77 each

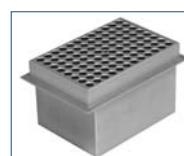

For 96-Well Plate (Single Block)

Cat. No: N2400-4107  
£121.28 each

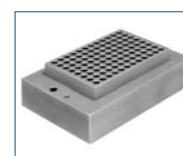

For 96-Well Plate (Dual Block)

Cat. No: N2400-4108  
£173.25 each

# Vortex Wizard with Infrared

## Simple, but revolutionary!

Vortex Wizard incorporates an optional Infrared (IR) motion detector which automatically starts the vibration when a tube crosses the sensor field.

The variable vibration speed allows low speeds for the gentle mixing of samples or higher speeds for vigorous vortex mixing and resuspending cells or chemical pellets.

## Features

- Ergonomic, low-profile design and anti-slide feet for bench stability
- ‘Sensor’ mode: Infrared detects the presence of the test tube and automatically starts vibration
- ‘Continuous’ mode: with the possibility to combine with the wide range of accessories to suit the most diverse of needs
- No pressure needed to maintain vibration
- Use in cold rooms or incubators



The Vortex Mixer can be set to Sensor Mode so the Infra-Red detects the presence of the tube and automatically starts vibrating

Specifications	
Speed Range	0–3000 rpm
Speed Setting	Analogic
Speed Control	Electronic
Operating Temp. Range	5°C – 40°C (max. humidity 80%)
Operational Modes	Two: sensor or continuous
Type of Movement	Orbital
Orbital Ø	4,5mm
Max. Load	0.5kg
Unit Material	Epoxy painted zinc alloy
Power	30 W
Power Supply	90 – 260 V / 50 –60 Hz
Safety	Electronic Protection Degree CEI EN 60529: IP42
Weight	2.4kg
Dimensions	180 x 220 x 70mm

Vortex Wizard with Infrared			
Cat. No.	Description	Pack Size	Price
N2400-0001	STARLAB Vortex Wizard	1	£228.17
N2400-1008	Replacement Cup for Single Test Tube	1	£13.34

The vortex wizard is supplied with a cup (N2400-1008) for single test tube (see main image).

## Vortex Accessories



For 19 x 1.5ml Microcentrifuge Tubes

Cat. No: N2400-1001  
£47.88 each



For 5 x 15 ml (16mm Ø) Centrifuge Tubes

Cat. No: N2400-1002  
£47.88 each



For 4 x 50 ml (29mm Ø) Centrifuge Tubes

Cat. No: N2400-1003  
£47.88 each



For Microtitre Plates

Cat. No: N2400-1004  
£47.88 each



Universal Foam Attachment (50mm Ø)

Cat. No: N2400-1005  
£26.67 each



Customisable Soft Foam Attachment

Cat. No: N2400-1006  
£38.96 each

# STARLAB Vortex



### Economical mixing!

A value for money vortexer with two modes: touch, where the motion is activated by pressure, or continuous, where it will operate continuously until turned off.

The small footprint and portability of the STARLAB vortex allows it to be used almost anywhere. The unit is safe for use in temperature controlled environments.

Specifications	
Speed Range	0 – 2850 rpm
Operating Modes	Two: Touch or Continuous
Ambeint Operating Range	4 – 65°C
Power	230V, 50Hz, 0.3A
Weight	2.2kg
Dimensions	140 x 160 x 130mm

Vortex			
Cat. No.	Description	Pack Size	Price
N2400-6000	STARLAB Vortex	1	£163.59
N2400-6001	Head for 24 x 1.5ml, 0.5ml and 32 x 0.2ml Tubes	1	£36.75
N2400-6002	Head for 1 Microplate or 64 x 0.2ml Tubes	1	£36.75
N2400-6003	Head for 8 x 15ml and 8 x 12/13mm Ø Tubes	1	£36.75
N2400-6004	Head for 6 x 50ml Tubes	1	£36.75

### STARLAB Tubes

See pages 58–67 for STARLAB's range of tubes.



# Plate Centrifuge

**New!**



## Compact and economical plate centrifuge

A compact and economical microcentrifuge for plates, and tubes if the . Small enough for personal use on your bench. Holds two plates.

## Features

- Quickly spin down droplets and condensation
- Use before and after thermal cycling to improve PCR yield
- Accepts all PCR plates – skirted, semi-skirted and non-skirted
- Adapter plate available for use with 0.2ml PCR tubes and strips

Plate Centrifuge			
Cat. No.	Description	Pack Size	Price
N2631-0008	STARLAB Plate Centrifuge	1	£510.00
N2631-0018	STARLAB Plate Centrifuge Adapter	1	£36.00

Specifications	
Spin Speed	2500 rpm
Rotor	Vertical, Fixed
Capacity	Two PCR Plates
Power	230V, 50-60Hz
Weight	3kg
Dimensions	190 x 210 x 183mm

## STARLAB PCR Plates

See pages 72–75 for STARLAB's range of skirted and non-skirted PCR plates.



## Minifuge



### Get in a spin!

Small enough to fit on your bench top for your own personal use. The strip rotor accepts either 16 single or two 8-strip 0.2ml tubes; the standard rotor accepts six 0.5ml or 1.5/2.0ml microcentrifuge tubes. The rotors can be changed easily and quickly.

### Features

- Supplied with two, interchangeable rotors, one for single and one for strip tubes
- Ideal for quick spin downs and microfiltration
- Starts and stops in seconds



Specifications	
Speed	6000 rpm
RCF Standard Rotor	2000 x g
RCF Strip Rotor	1177 x g
Power	115V, 60Hz, 130mA, or 240V, 50/60Hz, 65mA
Fuse	0.5A, 250V (F)
Dimensions	150 x 150 x 117mm

Microcentrifuge			
Cat. No.	Description	Pack Size	Price
N2631-0007	Microcentrifuge	1	£200.34

The microcentrifuge is supplied with: One power cord, two rotors ('Standard' for use with 1.5/2.0 ml tubes, and 'Strip' for use with 0.2ml tubes), six adaptors (to convert the Standard rotor for use with 0.5 ml tubes), and a wrench for changing the rotors.

### STARLAB Tubes

STARLAB has a full range of microcentrifuge tubes (pages 58–59) and PCR tubes (pages 68–71).

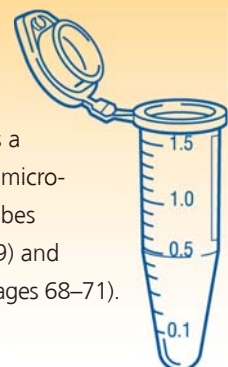



# *Protection*

## **DISPOSABLE GLOVES**

Microflex® Gloves Overview .....	134–135
Nitrile Gloves .....	136–137
Latex Gloves.....	138
Chloroprene Gloves.....	138
Vinyl Gloves .....	139
Glove Dispenser.....	139

## **LABORATORY DISINFECTANT**

Distel® Laboratory Disinfectant.....	140
--------------------------------------	-----

## **BENCHTOP SAFETY**

Safety Spill Trays & Liners .....	141
-----------------------------------	-----

## **DISPOSAL**

Autoclavable Sweet Jars .....	142
Autoclave Bags .....	142
Autoclave Tape.....	142
Radiation Disposal Bags .....	142
Self-Adhesive Radiation Labels .....	142

# Microflex® Gloves Overview



## STARLAB – hand in hand with MICROFLEX®

MICROFLEX® is a world-wide manufacturer and leader in disposable examination gloves. Their commitment to manufacturing consistent and reliable quality products and continuous research and innovation has helped them earn the reputation of being “The Most Trusted Name in Gloves®”.



## Passionate about advancing protection

MICROFLEX® has an uncompromising mission to research, design and manufacture the most secure, reliable, and comfortable disposable gloves. Their state of the art laboratory allows them to continually evolve and improve barrier protection standards.

## Protection that matters today and tomorrow

MICROFLEX® offers a range of gloves for different applications and user preferences. Glove comfort is essential to allow you to do your job well. MICROFLEX® continually researches and develops innovative products where comfort and hand health is at the forefront, in order to combat hand fatigue in the workplace.



Hand fatigue does not just impact on the work you do today. Over time, hand fatigue can lead to painful injuries, reduced productivity and even lost wages and shortened careers. Without compromising on superior barrier protection, MICROFLEX® has developed the XCEED® glove to reduce muscle fatigue. XCEED® has been recognised as the first Ergonomic Certified disposable glove.

## What does ergonomic certification mean?

According to US Ergonomics, a product that has received certification provides measurable ergonomic benefits to the users by improving comfort and fit and by **minimising the risk factors that may contribute to the development of ergonomic injuries.**<sup>1</sup>

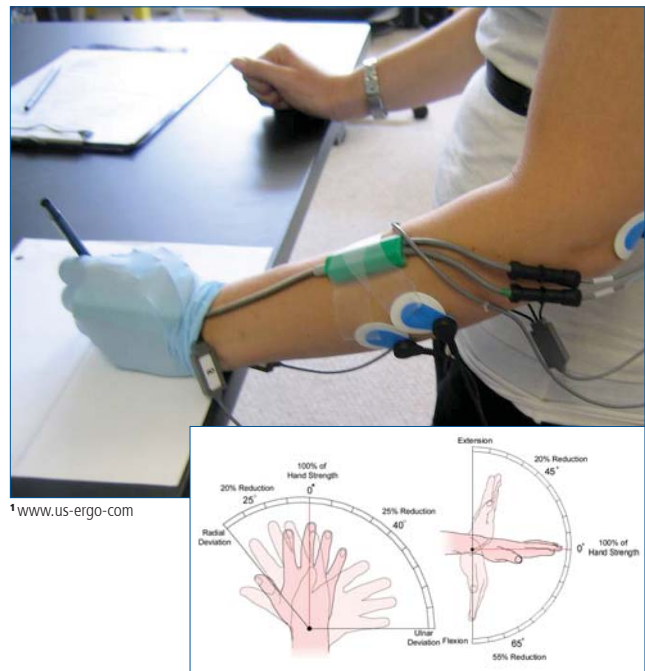

## Avantex™

- Avantex™ is an exclusive combination of MICROFLEX® advanced polymer manufacturing technology and proprietary formulation
- Avantex™ is the combination of comfort, protection and strength in a thin gauge disposable glove



# Microflex® Gloves Overview

Glove Material Specifications				
Material	Nitrile	Latex	Chloroprene	Vinyl
Properties	Synthetic rubber	Natural rubber	Synthetic rubber	Synthetic
Characteristics	<p><b>GOOD FOR:</b> Chemical splash protection, barrier protection against biohazards, water miscible substances, weak acids and alkalis (pH 4–10), aliphatic solvents, oil and grease, allergy sufferers.</p> <p><b>POOR FOR:</b> Direct contact with ketones.</p>	<p><b>GOOD FOR:</b> Barrier protection against blood-borne pathogens and other biohazards, water miscible substances, weak acids and alkalis (pH 4–10).</p> <p><b>POOR FOR:</b> Organic solvents, oils and grease, allergy sufferers.</p>	<p><b>GOOD FOR:</b> Puncture resistance, water miscible substances, strong alkalis (pH 11–14) and phenols, allergy sufferers.</p> <p><b>POOR FOR:</b> Organic solvents.</p>	<p><b>GOOD FOR:</b> Light duty tasks, water miscible substances, weak acids and alkalis (pH 4–10), allergy sufferers</p> <p><b>POOR FOR:</b> Organic solvents.</p>
Elasticity	Good	Best	Good	Poor
Strength	Best	Good	Best	Poor
Puncture resistance	Best	Good	Best	Poor
Chemical resistance	Best	Good	Best	Poor

## MICROFLEX® gloves tested twice for quality

All PPE Category III gloves must go through independent testing. MICROFLEX® puts their gloves through an additional internal QC procedure where every glove undergoes 12 tests to receive MICROFLEX's own Certificate of Compliance. Those 12 tests are: weight, length, palm width, cuff width, cuff thickness, palm thickness, fingertip thickness, modulus, ultimate elongation, tensile strength, powder content and protein content.

## Providing valuable protection in the laboratory

- PPE Category III, EC Directive 89/686/EEC
- EN 420
- EN 374-2: 2003 protection against chemical splashes
- EN 374-3: 2003 protection against chemical permeation
- European Medical Device Directive 93/42/EEC, CE Class 1
- Medical Gloves Standard ISO 11193-1
- EN 455 Parts 1, 2 & 3
- ASTM F1671 protection against penetration by blood-borne pathogens
- Manufactured under ISO 13485 standards



IMPORTANT: See the standards which apply for each glove on the following pages.



**Product Data Sheets**  
Download a copy from the STARLAB website

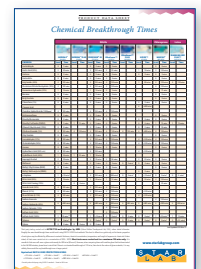

**Chemical Breakthrough Times**  
Download a copy from the STARLAB website



### Global impact of smart packaging

Smart packaging (2500 gloves per case) helps conserve the environment by reducing consumption of:

- Trees and packaging materials
- Energy and fuel
- Storage Space

# Nitrile Gloves

## XCEED®

### PPE Cat. III Complex Design. AQL 0.65

Blue Nitrile Glove. Powder-Free. Textured Fingers. Length: 240mm

Made from Microflex's exclusive **Avantex™** advanced polymer technology, these **unbelievably soft** gloves provide improved tactile sensitivity to help reduce hand fatigue. XCEED® sets a new standard in strength and durability – up to **60% stronger** than leading brands! Supplied in boxes of 250 gloves, the larger pack size **helps to conserve the environment** by reducing packaging materials, transport costs and storage space.

Recommended for use when:

- Work demands great dexterity and you need a glove to reduce hand fatigue
- You are looking for significantly stronger protection
- Working in environments that demand consistent grip and reliability
- Using Ethidium Bromide (Breakthrough: >480 mins)



### XCEED<sup>M</sup>

Cat. No.	Sizes Available	Pack Size	Price
XC-INT-#	XS, S, M, L, XL	10 x 250*	£306.08



XCEED® is the first glove to receive an award for ergonomics!

\*Pack size for XL gloves: 10 x 230.

## SUPRENO®

### PPE Cat. III Complex Design. AQL 0.65

Blue Nitrile Glove. Powder-Free. Textured Fingers. Length: 245mm

Recommended for use when:

- Contact with chemicals is a standard activity each day – Supreno provides excellent chemical splash protection!
- Strength and protection are of great importance
- Day to day hazards require the best combination of durability and security
- Working in environments that demand consistent grip and reliability



### SUPRENO®

Cat. No.	Sizes Available	Pack Size	Price
SU-INT-#	XS, S, M, L, XL	10 x 100	£132.83

## SUPRENO® PLUS

### PPE Cat. III Complex Design. AQL 0.65. Extended Cuff

Blue Nitrile Glove. Powder-Free. Textured Fingers. Length: 295mm

Recommended for use when:

- Contact with specific chemicals is a standard activity each day – Supreno Plus provides excellent chemical splash protection!
- Increased protection is needed over the wrist and forearm for enhanced safety – extended cuff!
- Day to day hazards require the best combination of durability and security



### SUPRENO® PLUS

Cat. No.	Sizes Available	Pack Size	Price
SP-INT-#	S, M, L, XL	10 x 50	£117.81

# Nitrile Gloves

## FREEFORM SE®

### PPE Cat. III Complex Design. AQL 1.5

Blue Nitrile Glove. Powder-Free. Textured Fingers. Length: 240mm.

Recommended for use when:

- Working in wet environments that demand a reliable grip
- Light to mid-duty tasks require a combination of comfort and durability
- Precise contact and softness require enhanced tactile sensitivity

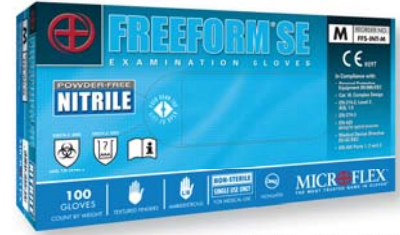

### FREEFORM® SE

Cat. No.	Sizes Available	Pack Size	Price
FFS-INT-#	XS, S, M, L, XL	10 x 100	£167.48

## UltraSense®

### PPE Cat. III Complex Design. AQL 1.5

Dark Blue Nitrile Glove. Powder-Free. Textured Fingers. Length: 240mm

Recommended for use when:

- Handling small instruments, where fit and feel is key
- Light tasks require excellent grip
- Performing extended or repetitive duties that may cause hand fatigue
- When your day to day duties require a glove that is resistant to tapes and adhesives



### UltraSense™

Cat. No.	Sizes Available	Pack Size	Price
US-INT-#	XS, S, M, L, XL	10 x 100	£132.83

## UltraSense® PLUS

### PPE Cat. III Complex Design. AQL 1.5. Extended Cuff

Dark Blue Nitrile Glove. Powder-Free. Textured Fingers. Length: 290mm

Recommended for use when:

- Strength and protection are of great importance
- Working in environments that demand consistent grip and reliability
- Increased protection is needed over the wrist and forearm for enhanced safety – extended cuff!
- When your day to day duties require a glove that is resistant to tapes and adhesives



### UltraSense™ PLUS

Cat. No.	Sizes Available	Pack Size	Price
USP-INT-#	XS, S, M, L, XL	10 x 100	£167.48

**FREE SAMPLE**  
**TRY**  
before you  
**BUY**  
available on request

## Latex Gloves

### DIAMOND GRIP PLUS®

#### PPE Cat. III Complex Design. AQL 1.5

Natural Latex Glove. Powder-Free. Fully Textured. Length: 245mm

Recommended for use when:

- Durable comfort is required for lasting wear
- Working with blood-borne pathogens
- Consistent grip is necessary for handling small instruments on a day to day basis
- Tactile sensitivity is important when working with a number of different instruments



#### DIAMOND GRIP PLUS™

Cat. No.	Sizes Available	Pack Size	Price
DGP-INT-#	XS, S, M, L, XL	10 x 100	£83.16

### SYNETRON® PLUS

#### MDD 93/42/EEC, Class 1. AQL 1.5. Extended Cuff

Natural Latex Glove. Powder-Free. Textured Fingers. Length: 290mm

Recommended for use when:

- Increased protection is required over the wrist – extended cuff!
- Working with blood-borne pathogens
- A thicker glove is needed



#### SYNETRON® PLUS

Cat. No.	Sizes Available	Pack Size	Price
SYP-INT-#	S, M, L, XL	10 x 50	£80.85

## Chloroprene Gloves

### NEOPRO®

#### PPE Cat. III Complex Design. AQL 1.5

Green Chloroprene Glove. Powder-Free. Textured Fingers. Length: 245mm

Recommended for use when:

- Contact with specific chemicals is a standard activity each day – NeoPro provides excellent chemical splash protection!
- You require the strength of a synthetic and desire the comfort of latex
- Working in wet environments, where an enhanced grip and tactile sensitivity are essential
- A synthetic alternative to nitrile is required



#### NEOPRO®

Cat. No.*	Sizes Available	Pack Size	Price
NPG-INT-#	XS, S, M, L, XL	10 x 100	£145.53

# Vinyl Gloves

## Derma Free®

### ASTM Medical Grade. AQL 1.5

Clear Vinyl Glove. Powder-Free. Smooth Exterior. Length: 290mm

Recommended for use when:

- Undertaking non-hazardous work
- Working with weak acids and alkalis (pH 4–10)
- You require economical hand protection for light duty tasks



Derma Free®			
Cat. No.*	Sizes Available	Pack Size	Price
DF-850-#	XS, S, M, L, XL	10 x 100	£55.44

**FREE SAMPLE**  
**TRY**  
before you  
**BUY**  
available on request

Product Data Sheets  
Download a copy from  
the STARLAB website



Chemical  
Breakthrough Times  
Download a copy from  
the STARLAB website

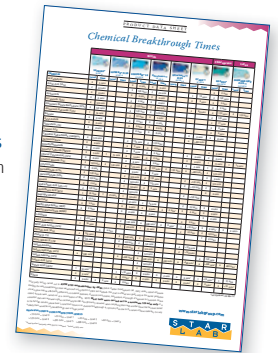

# Glove Dispenser



Free up your valuable bench space by keeping your gloves tidy in this wall-mounted dispenser. The epoxy-coated steel wire rack holds three boxes of gloves and is suitable for use with most brands and sizes of box.

Glove Dispenser			
Cat. No.	Description	Pack Size	Price
E3099-3100	Wire Glove Dispenser	1	£26.67

# Laboratory Disinfectant

Formally known as Trigene Advance

						
	<b>Concentrate</b>			<b>Ready to Use Spray</b>	<b>Cloth Wipes</b>	
Packaging:	1 Litre Self-Dosing Bottle	5 Litre Pump Container*	5 Litre Pump Container*	500ml Trigger Bottle	Dispensing Drum of 100 Wipes	Individually Wrapped Sachets
Formulation:	Clear, Unfragranced	Clear, Unfragranced	Blue, Eucalyptus	Clear, Unfragranced	Clear, Unfragranced	Clear, Unfragranced
Solution:	100%	100%	100%	1:100	1:10	1:100
CASE Ordering Info:	TM305-C £91.35 / 6 bottles	TM309-C £163.49 / 3 bottles	TM308-C £163.49 / 3 bottles	TM301-C £43.50 / 6 bottles	TM353-C £95.76 / 12 drums	n/a
PACK Ordering Info:	TM305 £30.45 / 2 bottles	TM309 £54.50 / 1 bottle	TM308 £54.50 / 1 bottle	TM301 £7.25 / 1 bottle	TM353 £7.98 / 1 drum	TM351 £77.91 / 250 sachets

\*Reusable pump for use with the 5 Litre Containers are supplied separately: Cat. No: TR021. £6.20 Each

# Distel

## Multi-purpose, multi-surface!

Distel® is an all purpose, multi-surface, non-alcohol base laboratory disinfectant that provides safe, simple and secure disinfecting. Economical to use, the synergistic blend of active ingredients produces the fastest acting and most efficient virucidal and sporicidal disinfectant available in non-oxidising technology.

## Product Summary

- Biodegradable
- Non-irritant
- Non-fuming
- Non-hazardous
- Non-corrosive
- Long shelf life! Diluted concentrate has a shelf life of up to 6 months

## Applications

Distel® can be used on most surfaces. It is ideal for cleaning laboratory benches, shelves, floors, fridges and most laboratory equipment, including pipettes, centrifuges and water baths.

- 1:200 for general pre-cleaned areas
- 1:100 for heavy soil and high risk areas
- 1:10 in the presence of blood and bio-hazard spillage

## Microbiological efficacy summary

### Viruses

Adenovirus Type 5.  
Human Coronavirus (SARS).  
Feline Calcivirus.  
Hepatitis B.  
Hepatitis C.  
HIV.  
Norovirus.

### Mycobacteria

*Mycobacterium avium.*  
*Mycobacterium bovis.*  
*Mycobacterium fortuitum.*  
*Mycobacterium terrae.*

### Fungi

*Aspergillus niger.*  
*Candida albicans.*  
*Pencillium verrucosum.*  
*Tirchophyton rubrum.*  
*Chrysonilias itophila.*

### Bacteria

*Pseudomonas aeruginosa.*  
*Staphylococcus aureus.*  
*Escherichia coli.*  
*Enterococcus hirae.*  
MRSA.

# Safety Spill Trays & Liners



## Define a safe working area!

Define your work area so you and your colleagues are safe. Unlike disposable paper bench protectors, these Safety Trays are reusable. This reduces running costs and drastically reduces contaminated waste volume. The APET tray liner is anti-static with a non-porous surface which, unlike absorbent paper protectors, allows valuable samples to be retrieved.

## Features

- Reusable! Saves on costs and reduces waste
- Raised edge contains any spills
- Provides a defined work area
- Rigid PVC spill tray bases designed for easy cleaning
- Allows you to retrieve valuable samples

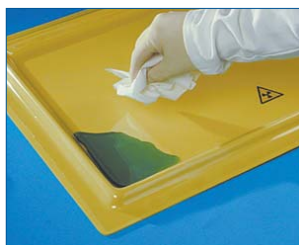

1. Spillages are easily cleared or retrieved

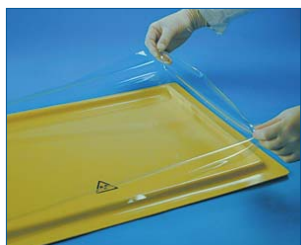

2. the Tray Liners lift off the Spill Tray... just stretch...



3. ...and roll up for disposal



4. Volume of waste is drastically reduced

Safety Spill Trays					
	Cat. No.	Description	Size	Pack Size	Price
<b>General Purpose Trays</b>					
	E3446-2609	General Purpose Tray, White	450 x 250mm	1	£29.72
	E3454-3409	General Purpose Tray, White	530 x 330mm	1	£35.60
	E3457-5409	General Purpose Tray, White	570 x 540mm	1	£46.73
	E3468-5409	General Purpose Tray, White	670 x 530mm	1	£75.71
	E3470-4609	General Purpose Tray, White	690 x 450mm	1	£60.06
	E3411-3549	General Purpose Tray, White	1120 x 530mm	1	£75.92
<b>Radiation Hazard Trays</b>					
	E3446-2606	Radiation Hazard Trays, Yellow	450 x 250mm	1	£29.72
	E3454-3406	Radiation Hazard Trays, Yellow	530 x 330mm	1	£35.60
	E3457-5406	Radiation Hazard Trays, Yellow	570 x 540mm	1	£46.73
	E3468-5406	Radiation Hazard Trays, Yellow	670 x 530mm	1	£60.06
	E3470-4606	Radiation Hazard Trays, Yellow	690 x 450mm	1	£60.06
	E3411-3546	Radiation Hazard Trays, Yellow	1120 x 530mm	1	£73.82
<b>Biohazard Trays</b>					
	E3646-2609	Biohazard Trays, White	450 x 250mm	1	£56.18
	E3654-3409	Biohazard Trays, White	530 x 330mm	1	£33.60
	E3657-5409	Biohazard Trays, White	570 x 540mm	1	£44.52
	E3668-5409	Biohazard Trays, White	670 x 530mm	1	£56.18
	E3670-4609	Biohazard Trays, White	690 x 450mm	1	£56.18
	E3611-3549	Biohazard Trays, White	1120 x 530mm	1	£69.83

Tray Liners		
Cat. No.	Pack Size	Price
E3546-2600	25	£47.36
E3554-3400	25	£65.00
E3557-5400	25	£66.99
E3568-5400	25	£94.40
E3570-4600	25	£91.46
E3511-3540	25	£111.30
<hr/>		
E3546-2600	25	£47.36
E3554-3400	25	£65.00
E3557-5400	25	£66.99
E3568-5400	25	£94.40
E3570-4600	25	£91.46
E3511-3540	25	£111.30

## Safe Disposal



### Autoclavable sweet jars

Portable waste containers, ideal for use either as a benchtop bin or for use in the laminar flow cabinet. Use for the safe disposal and storage of contaminated plasticware prior to autoclaving. When autoclaved, the polypropylene lid remains intact whilst the PET jar deforms to allow the steam inside to disinfect the contaminated material. The waste can then be safely disposed of.

Autoclavable Sweet Jars			
Cat. No.	Description	Pack Size	Price
E1412-0000	Small (2.5L) PET Sweet Jar with PP Lid with Handle	30	£65.63
E1412-0001	Large (4.25L) PET Sweet Jar with PP Lid	30	£65.63

Dimensions (WxDxH): Small 105 x 105 x 215mm (with handle down, flush on lid). Large 145 x 115 x 215mm



### Autoclave bags

- Polypropylene bags for autoclaving up to 136°C
- Printed with the Biohazard Symbol
- Use for contaminated waste disposal
- White write-on panel

Autoclave Bags			
Cat. No.	Description	Pack Size	Price
E3300-3166	Autoclave Bag, 310mm x 660mm	200	£35.60
E3300-4070	Autoclave Bag, 415mm x 600mm	200	£38.96
E3300-6078	Autoclave Bag, 610mm x 810mm	200	£72.35

**New!**

25mm wide tape now available

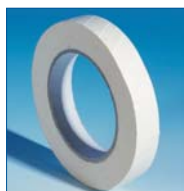

### Autoclave tape

Autoclave Tape			
Cat. No.	Description	Pack Size	Price
E3300-0000	Autoclave Tape (50m x 18mm)	4	£22.26
E3300-0001	Autoclave Tape (50m x 25mm)	4	£25.00



### Radiation disposal bags

Heavy-duty, double heat-sealed 500 gauge PE bags with double string neck pull.

Radiation Disposal Bags			
Cat. No.	Description	Pack Size	Price
E3317-0010	Bag with Radiation Hazard Symbol, 120 x 120 x 120mm	25	£32.34
E3331-0020	Bag with Radiation Hazard Symbol, 290 x 210 x 210mm	25	£58.80
E3335-0015	Bag with Radiation Hazard Symbol, 330 x 120 x 120mm	25	£63.74
E3340-0025	Bag with Radiation Hazard Symbol, 370 x 210 x 240mm	25	£44.42
E3342-0030	Bag with Radiation Hazard Symbol, 400 x 490 x 270mm	25	£48.30
E3360-0035	Bag with Radiation Hazard Symbol, 610 x 280 x 280mm	25	£60.06



Self-Adhesive Radiation Hazard Labels			
Cat. No.	Description	Pack Size	Price
E3825-0010	Radiation Hazard Labels (Small: 25 x 25mm)	25	£11.55
E3850-0015	Radiation Hazard Labels (Large: 50 x 50mm)	25	£12.60



# Alphabetical Index

## A

AirClean® PCR Cabinets ..... 124–125  
 Alpha-Numeric Coded Tubes .....62  
 Assay Plates .....84  
 Autoclave Bags .....87  
 Autoclavable Sweet Jars .....142  
 Autoclave Tape .....87, 142

## B

Bijou Containers.....66  
 Benchtop Coolers..... 111–112

## C

Calibration, Pipettes..... 50–54  
 Capp® Multi-Channel Pipettes .....44  
 Capp® Origami Reservoirs.....88  
 Cardboard Storage Boxes..... 98–99  
 Cell Scrapers .....89  
 Centrifuge Tubes .....61  
 Chloroprene Gloves.....138  
 Chiller Racks .....111  
 Containers  
   5ml to 250ml ..... 66–67  
   Bijou .....66  
   Cooler .....111  
   Universal .....67  
 Cryogenic Labels.....92  
 Cryogenic Storage  
   Canes.....63  
   Storage Racks.....104  
   Vials.....63  
 Culture Tubes .....66  
 Cuvettes .....87  
 Cuvette Storage Box .....102

## D

Dead Air Box ..... 124–125  
 Deepwell Plates ..... 80–82  
 DermaFree® Vinyl Gloves.....139  
 Diamond Grip Plus® Latex Gloves .....138  
 Disinfectant.....140  
 Dispenser Tips .....24  
 Disposal Products.....142  
 Disposable Gloves..... 134–139  
 Distel Disinfectant .....140  
 Dry Bath Incubators .....128

## E

ErgoOne® Pipettes ..... 40–43  
 Electronic Pipettes.....45  
 Extended Length Tips .....19

## F

Filter Tips, 300µl .....18  
 Filter Tips, TipOne® ..... 14–15

FreeForm® SE Nitrile Gloves .....137  
 Freezer Racking..... 114–119

## G

Gel-Xtraction Tool .....22  
 Gel-Loading Tips .....23  
 Gloves  
   Dispenser.....139  
   Chloroprene.....138  
   Latex.....138  
   Nitrile ..... 136–137  
   Vinyl .....139

## H / I

Heat Sealing Films.....85  
 Ice Bath / Floating Rack .....112  
 ID Tape .....94

## L

Label Printers & Labels..... 95–96  
 Laminar-Flow Cabinet..... 124–125  
 Large Volume Tips ..... 20–21  
 Latex Gloves .....  
 Loops .....89

## M

Magnetic Stirrers.....126  
 Microcentrifuge.....132  
 Microcentrifuge Tubes ..... 58–59  
 Microcentrifuge Tube Cap Locks.....60  
 Microflex® Gloves ..... 134–139  
 Microplates  
   Polypropylene .....83  
   Polystyrene .....84  
 Microtube Openers .....60  
 Microtube Pestles.....60  
 Microtubes in Racks..... 61–62

## N / O

NeoPro® Chloroprene Gloves .....138  
 Nitrile Gloves ..... 136–137  
 Orbital Shaker .....127

## P

Parafilm.....86  
 Parafilm Dispenser .....86  
 Pasteur Pipettes ..... 90–91  
 PCR  
   Cabinets ..... 124–125  
   Plate–Cycler Compatibility ..... 76–77  
   Plate–Sealing Overview.....78  
   Plates..... 72–75  
   Seals & Foils .....85  
   Strips ..... 69–71  
   Tubes .....68

Pestles, Microtube .....60  
 Petri Dish Racks .....113  
 Pipette Tips

  384-Format.....18  
   Extended Length.....19  
   Gel-Loading.....23  
   Large Volume..... 20–21  
   TipOne® ..... 6–17  
   Wide Orifice.....22

## Pipettes

  Aspiration.....47  
   Capp® .....44  
   Calibration..... 50–54  
   Electronic.....45  
   ErgoOne® ..... 40–43  
   Multi-Channel..... 43–45  
   Pasteur..... 90–91  
   Serological.....47  
   Single-Channel .....42, 45  
   Spares..... 55–56  
   Stands.....43  
   StarPet E .....45

Pipette Controllers .....46  
 Plate Microcentrifuge .....131  
 Pipette Servicing ..... 50–54

## Plates

  Assay, Polypropylene .....84  
   Deepwell ..... 80–82  
   Freezer Racking .....117  
   Lid for all SBS Plates .....82  
   Microplates, Polystyrene .....84  
   PCR..... 72–75  
   PlateOne® Deepwell .....79  
   PlateOne® Microplates .....84  
   Sealing Accessories.....86  
   Seals & Foils ..... 85

## R

Racks and Storage Boxes ..... 98–110  
 Radiation Disposal Bags.....142  
 Recycling.....11  
 Repeat Dispenser Tips .....24  
 RepeatOne® Dispenser.....48  
 Reservoirs  
   Reagent .....88  
   Robotic .....38  
 Robot–Tip Compatibility .....37  
 Robotic Tips  
   for Beckman® ..... 27–29  
   for Biotek® .....30  
   for Caliper®/Zymark® .....30  
   for Packard® .....31  
   for Perkin Elmer® ..... 32–33  
   for Qiagen® .....33  
   for Tecan® ..... 34–36

# Alphabetical Index

**S**

Safety Spill Trays & Liners.....141  
 Seal Applicators .....86  
 Seals .....85  
 Self-Adhesive  
     Lab Labels..... 92–93  
     Radiation Labels.....142  
 Serological Pipettes.....47  
 Shaker, Digital Orbital .....127  
 Slide  
     Mailers .....122  
     Staining .....122  
     Storage Boxes & Trays ..... 120–121  
 Spares  
     for ErgoOne® Pipettes.....55  
     for Gilson® Pipettes .....56  
 Scrapers .....89  
 Screw Cap Microtubes ..... 64–65  
 Spatulas .....92  
 Spray, Disinfectant .....140  
 Spreaders .....89  
 Stainless Steel  
     Storage .....113  
     Freezer Racking ..... 114–119  
 StarChill .....111  
 StarPet  
     Electronic Pipettes .....45  
     Pipette Controllers.....46  
 StarRacks .....107  
 StarSeals .....85  
 StarStore Storage Boxes..... 100–101

StarTags .....93  
 Stirrers, Magnetic.....126  
 Storage Boxes ..... 98–104  
 Supreno® Nitrile Gloves .....136  
 Supreno® Plus Nitrile Gloves.....136  
 Sweet Jars, Autoclavable.....142  
 Synetron® Plus Latex Gloves .....138

**T**

Tape  
     Autoclave .....87  
     ID.....94  
 TipOne®  
     Pipette Tip System ..... 6–17  
     Recycling .....11  
     Tips ..... 12–13  
     Filter Tips ..... 14–15  
     TipOne® RPT ..... 16–17  
     TipOne® Repeat .....24  
 Tubes  
     Centrifuge.....61  
     Cryogenic Vials .....63  
     Culture.....66  
     Microcentrifuge ..... 58–59  
     Microtubes in Racks ..... 61–62  
     PCR.....68  
     Preparation .....60  
     Screw Cap Microtubes..... 64–65  
     Storage..... 98–110  
     TubeOne® .....58  
 Transport Cases & Coolers .....112

**U**

UKAS Pipette Servicing .....54  
 UltraSense™ Nitrile Gloves .....137  
 UltraSense™ Plus Nitrile Gloves.....137  
 Universal Containers .....67

**V**

Vinyl Gloves .....139  
 Vortexers..... 129–130

**W**

Water Bath / Dry Bath Incubator .....128  
 Weigh Boats .....92  
 Wipes, Disinfectant .....140

**X**

Xceed™ Nitrile Gloves .....136  
 Xtracta™ Gel Tool .....22

## Index by Catalogue Number

<b>A</b>	A9623-8101 .....98	A9625-4902.....99	A9627-3104.....99	A9632-2566.....98	CC7600-0250.....89
A1188-0700.....36	A9623-8102 .....98	A9625-4904.....99	A9627-3106.....99	A9632-2569.....98	CC7600-0320.....89
A1188-0701.....36	A9623-8104 .....98	A9625-4906.....99	A9627-3100.....99	A9650-1361 .....99	
A1402-3700.....70	A9623-8106 .....98	A9625-4949.....99	A9627-4901.....99	A9650-1362.....99	<b>D</b>
A1402-3800.....70	A9623-8181 .....98	A9625-8101.....99	A9627-4902.....99	A9650-1364.....99	DF-850-M.....139
A9623-1601.....98	A9625-1601.....99	A9625-8102.....99	A9627-4904.....99	A9650-1366.....99	DF-850-L .....139
A9623-1602.....98	A9625-1602.....99	A9625-8104.....99	A9627-4906.....99	A9650-1369.....99	DF-850-S .....139
A9623-1604.....98	A9625-1604.....99	A9625-8106.....99	A9627-4949.....99		DF-850-XL.....139
A9623-1606.....98	A9625-1606.....99	A9625-8181.....99	A9627-8101.....99	<b>B</b>	DF-850-XS.....139
A9623-1616.....98	A9625-1616.....99	A9627-1601.....99	A9627-8102.....99	B1402-0595.....72	DGP-INT-M.....138
A9623-2525.....98	A9625-2501.....99	A9627-1602.....99	A9627-8104.....99	B1494-1005.....72	DGP-INT-L.....138
A9623-3101.....98	A9625-2502.....99	A9627-1604.....99	A9627-8106.....99	B1494-1024.....79	DGP-INT-S.....138
A9623-3102.....98	A9625-2504.....99	A9627-1606.....99	A9627-8181.....99	B1494-1124.....79	DGP-INT-XL.....138
A9623-3104.....98	A9625-2506.....99	A9627-1616.....99	A9632-1961.....98	B1494-1224.....79, 83	DGP-INT-XS.....138
A9623-3106.....98	A9625-2525.....99	A9627-2501.....99	A9632-1962.....98		
A9623-3100.....98	A9625-3101.....99	A9627-2502.....99	A9632-1964.....98	<b>C</b>	<b>E</b>
A9623-4901.....98	A9625-3102.....99	A9627-2504.....99	A9632-1966.....98	C-10-48.....44	E1009-5000 .....20
A9623-4902.....98	A9625-3104.....99	A9627-2506.....99	A9632-1969.....98	C-10-64.....44	E1009-5700 .....20
A9623-4904.....98	A9625-3106.....99	A9627-2525.....99	A9632-2561.....98	CA-40505.....88	E1009-5718 .....20
A9623-4906.....98	A9625-3100.....99	A9627-3101.....99	A9632-2562.....98	CA-40510.....88	E1009-7000 .....20
A9623-4949.....98	A9625-4901.....99	A9627-3102.....99	A9632-2564.....98	CC7600-0220.....89	E1009-7001 .....20

# Index by Catalogue Number

E1011-0921 .....19	E1075-4488-C.....27	E1171-0402 .....35	E1178-6418 .....32	E1412-4450 .....87	E1420-2850 .....59
E1011-1002 .....19	E1076-0400 .....28	E1171-0402-C.....35	E1178-6418-C .....32	E1412-4451 .....87	E1420-5100 .....59
E1011-1008 .....19	E1076-0400-C.....28	E1171-0410 .....35	E1178-6428 .....32	E1412-5012 .....89	E1420-5108 .....59
E1011-1420 .....19	E1076-0410 .....28	E1171-0410-C.....35	E1178-6428-C .....32	E1412-6000 .....67	E1450-0000 .....60
E1011-1430 .....19	E1076-0410-C.....28	E1171-0412 .....35	E1178-6488 .....32	E1412-6004 .....67	E1450-0001 .....60
E1011-8000 .....22	E1076-0418 .....28	E1171-0412-C.....35	E1178-6488-C .....32	E1412-6104 .....67	E1450-0002 .....60
E1011-8400 .....22	E1076-0418-C.....28	E1171-0418 .....35	E1250-0000 .....20	E1412-6200 .....66	E1450-0004 .....60
E1011-8410 .....22	E1076-0700 .....29	E1171-0418-C.....35	E1250-0700 .....20	E1412-6201 .....66	E1450-0006 .....60
E1011-8800 .....22	E1076-0700-C.....29	E1171-0488 .....35	E1250-0710 .....20	E1412-6300 .....66	E1450-0008 .....60
E1011-9000 .....22	E1076-0710 .....29	E1171-0488-C.....35	E1250-0718 .....20	E1412-7000 .....66	E1450-0200 .....61
E1011-9500 .....22	E1076-0710-C.....29	E1172-1400 .....35	E1400-2099 .....122	E1412-7100 .....67	E1450-0500 .....61
E1011-9510 .....22	E1076-0800 .....29	E1172-1400-C.....35	E1403-0000 ... 72, 73, 74, 75	E1412-7200 .....92	E1450-0800 .....61
E1011-9600 .....22	E1076-0800-C.....29	E1172-1402 .....35	E1403-0100 .....72	E1412-7201 .....92	E1450-1000 .....60
E1011-9601 .....22	E1076-0810 .....29	E1172-1402-C.....35	E1403-0200 .....72	E1412-7202 .....92	E1480-0100 .....64
E1011-9611 .....22	E1076-0810-C.....29	E1172-1410 .....35	E1403-0208 .....72	E1412-7203 .....92	E1480-0101 .....64
E1011-9618 .....22	E1076-1400 .....28	E1172-1410-C.....35	E1403-0209 .....72	E1412-7204 .....92	E1480-0102 .....64
E1015-1801 .....30, 36	E1076-1400-C.....28	E1172-1412 .....35	E1403-1200 .....72	E1412-7205 .....92	E1480-0103 .....64
E1015-1801-C .....30, 36	E1076-1410 .....28	E1172-1412-C.....35	E1403-1208 .....72	E1414-0100 .....90	E1480-0104 .....64
E1015-2000 .....36	E1076-1410-C.....28	E1172-1418 .....33, 35	E1403-1209 .....72	E1414-0110 .....90	E1480-0105 .....64
E1015-2000-C .....36	E1076-2400 .....28	E1172-1418-C .....33, 35	E1403-2200 .....73	E1414-0111 .....90	E1480-0106 .....64
E1015-2010 .....36	E1076-2400-C.....28	E1172-1488 .....35	E1403-3200 .....73	E1414-0300 .....90	E1480-0107 .....64
E1015-2010-C .....36	E1076-2410 .....28	E1172-1488-C.....35	E1403-4200 .....73	E1414-0310 .....90	E1480-0108 .....64
E1015-2810 .....36	E1076-2410-C.....28	E1173-2400 .....35	E1403-5200 .....75	E1414-0311 .....90	E1480-0199 .....64
E1015-2810-C .....36	E1076-2418 .....28	E1173-2400-C.....35	E1403-5200-BC.....73	E1414-0500 .....90	E1480-0200 .....64
E1015-5800 .....30, 36	E1076-2418-C.....28	E1173-2402 .....35	E1403-5208 .....75	E1414-0700 .....90	E1480-0201 .....64
E1015-5800-C .....30, 36	E1076-3400 .....28	E1173-2402-C.....35	E1403-5209 .....75	E1414-1100 .....90	E1480-0202 .....64
E1015-5810 .....30, 36	E1076-3400-C.....28	E1173-2410 .....35	E1403-5300 .....75	E1414-1300 .....90	E1480-0203 .....64
E1015-5810-C .....30, 36	E1076-3410 .....28	E1173-2410-C.....35	E1403-6200 .....74	E1414-1310 .....90	E1480-0204 .....64
E1021-0618 .....23	E1076-3410-C.....28	E1173-2412 .....35	E1403-6208 .....74	E1414-1311 .....90	E1480-0205 .....64
E1022-0008 .....23	E1076-3810 .....28	E1173-2412-C.....35	E1403-6209 .....74	E1414-2500 .....90	E1480-0206 .....64
E1025-1810 .....30, 36	E1076-3810-C.....28	E1173-2418 .....33, 35	E1403-7200 .....74	E1415-0200 .....61	E1480-0207 .....64
E1025-1810-C .....30, 36	E1076-4400 .....28	E1173-2418-C .....33, 35	E1403-7709 .....74	E1415-0301 .....65	E1480-0208 .....64
E1025-1811 .....30, 36	E1076-4400-C.....28	E1173-2488 .....35	E1403-8200 .....74	E1415-0302 .....65	E1480-0299 .....64
E1025-1811-C .....30, 36	E1076-4410 .....28	E1173-2488-C.....35	E1403-8200-BC.....73	E1415-0303 .....65	E1480-0300 .....64
E1025-5810 .....30, 36	E1076-4410-C.....28	E1175-3400 .....35	E1403-8209 .....74	E1415-0306 .....65	E1480-0301 .....64
E1025-5810-C .....30, 36	E1076-4418 .....28	E1175-3400-C.....35	E1405-030# .....65	E1415-0311 .....65	E1480-0302 .....64
E1042-2350 .....75	E1076-4418-C.....28	E1175-3402 .....35	E1405-0600 .....58	E1415-0312 .....65	E1480-0303 .....64
E1042-2500 .....75	E1076-4700 .....29	E1175-3402-C.....35	E1405-0610 .....58	E1415-0314 .....65	E1480-0304 .....64
E1042-3000 .....75	E1076-4710 .....29	E1175-3410 .....35	E1405-2120 .....64	E1415-0316 .....65	E1480-0305 .....64
E1042-3840 .....75	E1076-4710-C.....29	E1175-3410-C.....35	E1405-2127 .....64	E1415-0800 .....61	E1480-0306 .....64
E1042-3849 .....75	E1076-4800 .....29	E1175-3412 .....35	E1405-2130 .....64	E1415-1500 .....58	E1480-0309 .....64
E1042-9909 .....75	E1076-4800-C.....29	E1175-3412-C.....35	E1405-2140 .....64	E1415-1510 .....58	E1480-0399 .....64
E1074-2100 .....30	E1076-4810 .....29	E1175-3418 .....35	E1405-2141 .....65	E1415-2210 .....64	E1494-6001 .....63
E1074-2100-C .....30	E1076-4810-C.....29	E1175-3418-C.....35	E1405-2142 .....65	E1415-2220 .....64	E1494-6002 .....63
E1074-2110 .....30	E1076-5401 .....28	E1175-3488 .....35	E1405-2143 .....65	E1415-2227 .....64	E1494-6003 .....63
E1074-2110-C .....30	E1076-5401-C.....28	E1175-3488-C.....35	E1405-2600 .....59	E1415-2230 .....64	E1494-6004 .....63
E1074-2118 .....30	E1076-5411 .....28	E1178-2400 .....32	E1405-5100 .....59	E1415-2231 .....65	E1494-6104 .....63
E1074-2118-C .....30	E1076-5411-C.....28	E1178-2400-C.....32	E1405-9000 .....60	E1415-2232 .....65	E1494-6005 .....63
E1074-2200 .....30	E1076-5810 .....28	E1178-2408 .....32	E1410-1025 .....89	E1415-2233 .....65	E1494-6006 .....63
E1074-2200-C .....30	E1076-5810-C.....28	E1178-2408-C.....32	E1412-0000 .....142	E1415-2237 .....64	E1494-6007 .....63
E1074-2210 .....30	E1078-2400 .....33	E1178-2410 .....32	E1412-0001 .....142	E1415-2240 .....64	E1494-6108 .....63
E1074-2210-C .....30	E1078-2400-C.....33	E1178-2410-C.....32	E1412-0111 .....89	E1415-2241 .....65	E1494-6009 .....63
E1074-2218 .....30	E1078-2410 .....33	E1178-2418 .....32	E1412-0112 .....89	E1415-2242 .....65	E1494-6099 .....63
E1074-2400 .....30	E1078-2410-C.....33	E1178-2418-C.....32	E1412-0710 .....66	E1415-2243 .....65	E1500-0011 .....121
E1074-2400-C .....30	E1078-2810 .....33	E1178-5400 .....32	E1412-0711 .....66	E1415-2600 .....59	E1500-0012 .....121
E1074-2410 .....30	E1078-2810-C.....33	E1178-5400-C.....32	E1412-1000 .....67	E1415-2850 .....59	E1500-0014 .....121
E1074-2410-C .....30	E1078-5400 .....33	E1178-5408 .....32	E1412-1001 .....89	E1420-030# .....65	E1500-0016 .....121
E1074-2418 .....30	E1078-5400-C.....33	E1178-5408-C.....32	E1412-1005 .....89	E1420-031# .....65	E1500-0019 .....121
E1074-2418-C .....30	E1078-5410 .....33	E1178-5410 .....32	E1412-1011 .....89	E1420-2000 .....58	E1500-0021 .....121
E1074-2500 .....30	E1078-5410-C.....33	E1178-5410-C.....32	E1412-1012 .....89	E1420-2010 .....58	E1500-0022 .....121
E1074-2500-C .....30	E1078-5418 .....33	E1178-5418 .....32	E1412-1200 .....66	E1420-2320 .....64	E1500-0024 .....121
E1074-2510 .....30	E1078-5418-C.....33	E1178-5418-C.....32	E1412-1500 .....67	E1420-2330 .....64	E1500-0026 .....121
E1074-2510-C .....30	E1078-6400 .....33	E1178-5428 .....32	E1412-2500 .....67	E1420-2331 .....65	E1500-0029 .....121
E1074-2518 .....30	E1078-6400-C.....33	E1178-5428-C.....32	E1412-3010 .....67	E1420-2332 .....65	E1500-0031 .....121
E1074-2518-C .....30	E1078-6410 .....33	E1178-5488 .....32	E1412-3011 .....67	E1420-2333 .....65	E1500-0032 .....121
E1075-3700 .....27	E1078-6410-C.....33	E1178-5488-C.....32	E1412-3012 .....67	E1420-2337 .....64	E1500-0036 .....121
E1075-3700-C .....27	E1078-6418 .....33	E1178-6400 .....32	E1412-3020 .....67	E1420-2340 .....64	E1500-0038 .....121
E1075-3710 .....27	E1078-6418-C.....33	E1178-6400-C.....32	E1412-3021 .....67	E1420-2341 .....65	E1500-0039 .....121
E1075-3710-C .....27	E1130-8810 .....18	E1178-6408 .....32	E1412-3022 .....67	E1420-2342 .....65	E1500-0041 .....122
E1075-3810 .....27	E1130-8810-C.....18	E1178-6408-C.....32	E1412-3025 .....87	E1420-2343 .....65	E1500-0042 .....122
E1075-3810-C .....27	E1171-0400 .....35	E1178-6410 .....32	E1412-4160 .....87	E1420-2347 .....64	E1500-0044 .....122
E1075-4488 .....27	E1171-0400-C.....35	E1178-6410-C.....32	E1412-4250 .....87	E1420-2641 .....65	E1500-0046 .....122

# Index by Catalogue Number

E1500-0048 .....122	E2340-4043 .....107	E2382-6002 .....103	E2796-0714 .....85	E3300-0000 .....87	E9025-1650 .....102
E1500-0049 .....122	E2340-4044 .....107	E2382-6003 .....103	E2796-0793 .....85	E3300-0001 .....142	E9025-3615 .....102
E1500-0058 .....122	E2340-4046 .....107	E2382-6004 .....103	E2796-0794 .....85	E3300-0001 .....87	E9026-0000 .....94
E1500-0099 .....121	E2344-1099 .....108	E2382-6006 .....103	E2796-0796 .....85	E3300-0010 .....92	E9026-2005 .....94
E1500-1001 .....120	E2344-2099 .....110	E2382-6099 .....103	E2796-3005 .....85	E3300-0011 .....92	E9055-1270 .....94
E1500-1002 .....120	E2345-1000 .....108	E2383-5001 .....103	E2796-3015 .....85	E3300-0025 .....92	E9055-1271 .....94
E1500-1008 .....120	E2345-1041 .....108	E2383-5002 .....103	E2796-3020 .....85	E3300-0030 .....92	E9055-1272 .....94
E1500-1101 .....120	E2345-1042 .....108	E2383-5003 .....103	E2796-3060 .....85	E3300-0050 .....92	E9055-1273 .....94
E1500-1102 .....120	E2345-1043 .....108	E2383-5004 .....103	E2796-3070 .....85	E3300-0070 .....92	E9055-1274 .....94
E1500-1201 .....120	E2345-1044 .....108	E2383-5006 .....103	E2796-3090 .....85	E3300-3166 .....142	E9055-1275 .....94
E1500-1202 .....120	E2345-1046 .....108	E2383-5099 .....103	E2796-9792 .....85	E3300-3166 .....87	E9055-1276 .....94
E1500-1301 .....120	E2345-1099 .....108	E2384-1000 .....82	E2796-9793 .....85	E3300-4070 .....142	E9055-1278 .....94
E1500-1302 .....120	E2346-1000 .....108	E2384-2000 .....82	E2796-9795 .....85	E3300-4070 .....87	E9055-1279 .....94
E1500-1408 .....120	E2346-1041 .....108	E2384-2400 .....82	E2824-0000 .....82	E3300-6078 .....142	E9055-1910 .....94
E1500-2009 .....120	E2346-1042 .....108	E2390-5000 .....105	E2824-0001 .....82	E3300-6078 .....87	E9055-1911 .....94
E1500-3009 .....120	E2346-1043 .....108	E2396-0010 .....107	E2848-0000 .....82	E3317-0010 .....142	E9055-1912 .....94
E1500-4000 .....122	E2346-1044 .....108	E2396-0011 .....107	E2848-5010 .....82	E3331-0020 .....142	E9055-1913 .....94
E1500-4099 .....122	E2346-1046 .....108	E2396-0012 .....107	E2896-0110 .....80	E3335-0015 .....142	E9055-1914 .....94
E1702-8400 .....61	E2346-1099 .....108	E2396-0013 .....107	E2896-0120 .....80	E3340-0025 .....142	E9055-1915 .....94
E1702-8410 .....61	E2347-1001 .....108	E2396-0014 .....107	E2896-0210 .....81	E3342-0030 .....142	E9055-1916 .....94
E1703-9400 .....61	E2347-1002 .....108	E2396-0015 .....107	E2896-0220 .....81	E3360-0035 .....142	E9055-1918 .....94
E1703-9410 .....61	E2347-1003 .....108	E2396-0016 .....107	E2896-0320 .....80	E3411-3546 .....141	E9055-1919 .....94
E1710-0000 .....61	E2347-1004 .....108	E2396-0018 .....107	E2896-0600 .....80	E3411-3549 .....141	E9055-2500 .....94
E1720-8000 .....61	E2347-1005 .....108	E2396-0041 .....107	E2896-1100 .....80, 81, 84	E3446-2606 .....141	E9055-2501 .....94
E1730-9000 .....61	E2347-1099 .....108	E2396-0042 .....107	E2896-1110 .....80, 81, 84	E3446-2609 .....141	E9055-2502 .....94
E1750-0400 .....61	E2349-5009 .....100	E2396-0043 .....107	E2896-1200 .....81	E3454-3406 .....141	E9055-2503 .....94
E1750-0410 .....61	E2350-4001 .....104	E2396-0044 .....107	E2896-1801 .....79, 81	E3454-3409 .....141	E9055-2504 .....94
E1760-8400 .....61	E2350-4002 .....104	E2396-0046 .....107	E2896-1810 .....81	E3457-5406 .....141	E9055-2505 .....94
E1760-8410 .....61	E2350-4005 .....104	E2396-0599 .....109	E2896-1820 .....81	E3457-5409 .....141	E9055-2506 .....94
E1770-9400 .....61	E2350-5009 .....101	E2396-1200 .....102	E2896-2100 .....81	E3468-5406 .....141	E9055-2508 .....94
E1770-9410 .....61	E2364-1000 .....105	E2396-1515 .....106	E2896-2110 .....81	E3468-5409 .....141	E9055-2509 .....94
E1780-2100 .....62	E2364-1010 .....107	E2396-1550 .....106	E2896-2200 .....80, 81, 84	E3470-4606 .....141	E9127-1270 .....94
E1780-2700 .....62	E2364-1011 .....107	E2396-1612 .....106	E2896-2500 .....81	E3470-4609 .....141	E9127-1271 .....94
E1780-3100 .....62	E2364-1012 .....107	E2396-1641 .....110	E2896-2501 .....81	E3511-3540 .....141	E9127-1272 .....94
E1780-3700 .....62	E2364-1013 .....107	E2396-1642 .....110	E2996-0500 .....84	E3546-2600 .....141	E9127-1273 .....94
E1780-8400 .....62	E2364-1014 .....107	E2396-1643 .....110	E2996-0510 .....84	E3554-3400 .....141	E9127-1274 .....94
E1780-8500 .....62	E2364-1015 .....107	E2396-1644 .....110	E2996-1500 .....84	E3557-5400 .....141	E9127-1275 .....94
E2005-5000 .....63	E2364-1016 .....107	E2396-1646 .....110	E2996-1510 .....84	E3568-5400 .....141	E9127-1276 .....94
E2100-1100 .....100	E2364-1018 .....107	E2396-1650 .....106	E2996-1600 .....84	E3570-4600 .....141	E9127-1278 .....94
E2100-1101 .....100	E2364-1041 .....107	E2396-1651 .....110	E2996-1610 .....84	E3611-3549 .....141	E9127-1279 .....94
E2100-1102 .....100	E2364-1042 .....107	E2396-1652 .....110	E2996-1700 .....84	E3646-2609 .....141	E9127-1910 .....94
E2100-1104 .....100	E2364-1043 .....107	E2396-1653 .....110	E2996-1710 .....84	E3654-3409 .....141	E9127-1911 .....94
E2100-1108 .....100	E2364-1044 .....107	E2396-1654 .....110	E2996-1800 .....84	E3657-5409 .....141	E9127-1912 .....94
E2100-5000 .....102	E2364-1046 .....107	E2396-1656 .....110	E2996-1810 .....84	E3668-5409 .....141	E9127-1913 .....94
E2100-5001 .....102	E2364-6048 .....107	E2396-1712 .....106	E2996-1900 .....84	E3670-4609 .....141	E9127-1914 .....94
E2100-5002 .....102	E2364-6099 .....107	E2396-1750 .....106	E2996-1910 .....84	E3825-0010 .....142	E9127-1915 .....94
E2100-5004 .....102	E2380-5000 .....105	E2396-2004 .....111	E2999-0000 .....38	E3840-3000 .....18	E9127-1916 .....94
E2100-5006 .....102	E2380-5001 .....105	E2396-2006 .....111	E2999-0000 .....82	E3840-3010 .....18	E9127-1918 .....94
E2100-5008 .....102	E2380-5008 .....105	E2396-5240 .....109	E2999-0901 .....38	E3840-5000 .....18	E9127-1919 .....94
E2105-5000 .....105	E2380-5041 .....105	E2396-5634 .....111	E2999-2112 .....38	E3840-5010 .....18	E9127-2500 .....94
E2105-5001 .....105	E2380-5042 .....105	E2396-5636 .....111	E2999-2384 .....38	E3841-5000 .....18	E9127-2501 .....94
E2105-5002 .....105	E2380-5043 .....105	E2396-5654 .....111	E2999-2496 .....38	E3841-5010 .....18	E9127-2502 .....94
E2105-5004 .....105	E2380-5044 .....105	E2396-5656 .....111	E2999-2908 .....38	E3850-0015 .....142	E9127-2503 .....94
E2105-5006 .....105	E2380-5046 .....105	E2396-6001 .....111	E2999-2912 .....38	E4266-0030 .....46	E9127-2504 .....94
E2115-5000 .....102, 105	E2380-5048 .....105	E2396-6002 .....111	E2999-3208 .....38	E4266-0040 .....46	E9127-2505 .....94
E2115-5001 .....102, 105	E2380-6000 .....109	E2396-6004 .....111	E2999-8008 .....38	E4266-0050 .....46	E9127-2506 .....94
E2115-5002 .....102, 105	E2380-6001 .....109	E2396-6008 .....111	E2999-8412 .....38	E4266-0890 .....46	E9127-2508 .....94
E2115-5004 .....102, 105	E2380-6002 .....109	E2396-9649 .....110	E2999-8696 .....38	E4860-0100 .....47	E9127-2509 .....94
E2115-5006 .....102, 105	E2380-6003 .....109	E2396-9659 .....110	E2999-9238 .....38	E4860-0111 .....47	E9127-2940 .....86
E2200-1000 .....102	E2380-6004 .....109	E2396-9669 .....110	E3090-6212 .....63	E4860-0200 .....47	E9185-0001 .....93
E2200-1008 .....102	E2380-6006 .....109	E2396-9691 .....110	E3090-6222 .....63	E4860-0211 .....47	E9185-0002 .....93
E2300-5005 .....100	E2381-5001 .....103	E2396-9692 .....110	E3090-6242 .....63	E4860-0500 .....47	E9185-0003 .....93
E2301-5309 .....104	E2381-5002 .....103	E2396-9693 .....110	E3090-6321 .....63	E4860-0511 .....47	E9185-0004 .....93
E2305-6009 .....101	E2381-5003 .....103	E2396-9694 .....110	E3099-0000 .....43	E4860-1000 .....47	E9185-0006 .....93
E2310-1000 .....88	E2381-5004 .....103	E2396-9696 .....110	E3099-0001 .....43	E4860-1011 .....47	E9185-0009 .....93
E2310-1010 .....88	E2381-5006 .....103	E2396-9759 .....104	E3099-3100 .....139	E4860-1211 .....47	E9185-0159 .....93
E2310-1200 .....88	E2381-5099 .....103	E2396-9769 .....106	E3110-6112 .....63	E4860-2500 .....47	E9185-0509 .....93
E2310-1812 .....88	E2382-5001 .....103	E2396-9779 .....106	E3110-6121 .....63	E4860-2511 .....47	E9185-2240 .....93
E2310-2000 .....88	E2382-5002 .....103	E2450-5000 .....101	E3110-6122 .....63	E4860-5012-C .....47	E9186-9987 .....93
E2313-1009 .....109	E2382-5003 .....103	E2450-5001 .....101	E3110-6131 .....63	E4866-0021 .....46	E9187-1009 .....93
E2340-3099 .....107	E2382-5004 .....103	E2450-5002 .....101	E3110-6132 .....63	E4866-1000 .....46	E9187-2016 .....93
E2340-4000 .....107	E2382-5006 .....103	E2450-5004 .....101	E3110-6141 .....63	E4866-2000 .....46	E9188-1009 .....93
E2340-4041 .....107	E2382-5099 .....103	E2450-5006 .....101	E3110-6142 .....63	E8800-0500 .....44	E9188-7925 .....93
E2340-4042 .....107	E2382-6001 .....103	E2450-5099 .....101	E3300-0000 .....142	E8800-0600 .....44	E9188-8699 .....93

# Index by Catalogue Number

E9189-0099.....63, 92	I1050-0728.....21	I1409-5700.....69, 71	I2602-7081.....119	I2652-7800.....117	N0082-4999.....96
E9189-1009.....93	I1052-0000.....21	I1412-7400.....62	I2602-8000.....118	I2653-1120.....117	N0086-4619.....96
E9189-2009.....93	I1052-0001.....21	I1412-7410.....62	I2602-9000.....118	I2653-2000.....117	N0097-4889.....96
E9189-3009.....63, 92	I1052-0010.....21	I1415-1000.....59	I2610-0800.....115	I2653-3000.....117	N0108-4619.....96
E9199-0000.....93	I1053-0000.....20	I1415-1007.....59	I2610-0920.....115	I2653-4500.....117	N0117-4999.....96
<b>F</b>	I1053-0700.....20	I1415-1508.....60	I2610-1200.....115	I2653-7800.....117	N0118-4999.....96
FFS-INT-M.....137	I1053-0710.....20	I1415-5100.....59	I2610-1220.....115	I2662-1120.....117	N0119-4619.....96
FFS-INT-L.....137	I1053-0728.....20	I1415-5390.....60	I2610-1500.....115	I2662-2000.....117	N2000-0025.....22
FFS-INT-S.....137	I1054-0000.....21	I1420-2600.....59	I2610-1620.....115	I2662-3000.....117	N2000-0100.....22
FFS-INT-XL.....137	I1054-0001.....21	I1420-2700.....59	I2610-1800.....119	I2662-4500.....117	N2400-0001.....129
FFS-INT-XS.....137	I1054-0011.....21	I1420-2707.....59	I2610-1900.....119	I2662-7800.....117	N2400-1001.....129
	I1054-0028.....21	I1485-0810.....66	I2610-2000.....119	I2670-1680.....116	N2400-1002.....129
	I1060-2400.....27	I1485-2810.....66	I2610-2100.....119	I2670-1760.....116	N2400-1003.....129
<b>G</b>	I1060-2400-C.....27	I1494-1400.....62	I2610-2200.....119	I2670-1760.....116	N2400-1004.....129
G8965-8000.....43	I1060-2410.....27	I1494-1410.....62	I2610-2200.....119	I2670-1848.....116	N2400-1005.....129
G9900-0010.....45	I1060-2410-C.....27	I2310-5800.....101	I2611-1500.....115	I2670-1936.....116	N2400-1006.....129
G9900-0020.....45	I1060-2810-C.....27	I2310-5841.....101	I2611-1600.....115	I2670-2100.....116	N2400-1008.....129
G9900-0200.....45	I1060-5400.....27	I2310-5842.....101	I2611-2000.....115	I2670-2200.....116	N2400-1008.....129
G9900-1200.....45	I1060-5400-C.....27	I2310-5843.....101	I2611-2100.....115	I2670-2310.....116	N2400-2000.....126
G9908-0010.....45	I1060-5410.....27	I2310-5844.....101	I2611-2400.....115	I2670-2420.....116	N2400-3000.....126
G9908-0020.....45	I1060-5410-C.....27	I2310-5846.....101	I2612-1000.....118	I2670-2940.....116	N2400-4001.....128
G9908-0200.....45	I1060-5810.....27	I2310-5848.....101	I2612-1100.....118	I2670-3080.....116	N2400-4002.....128
G9908-1200.....45	I1060-5810-C.....27	I2312-2720.....112	I2612-1200.....118	I2670-3234.....116	N2400-4100.....128
G9912-0010.....45	I1062-0400.....27	I2312-2721.....112	I2612-1300.....118	I2670-3388.....116	N2400-4101.....128
G9912-0020.....45	I1062-0400-C.....27	I2324-5000.....112	I2612-1300.....118	I2671-0030.....113	N2400-4102.....128
G9912-0200.....45	I1062-0410.....27	I2344-1000.....108	I2612-3000.....118	I2671-0057.....113	N2400-4103.....128
G9912-1200.....45	I1062-0410-C.....27	I2344-1040.....108	I2612-3300.....114	I2671-0060.....113	N2400-4104.....128
G9999-0003.....45	I1062-0810.....27	I2349-1025.....100	I2612-3500.....114	I2671-2825.....113	N2400-4105.....128
G9999-0006.....45	I1062-0810-C.....27	I2350-1025.....101	I2612-4300.....114	I2671-2830.....113	N2400-4106.....128
	I1400-0800.....69	I2350-5800.....101	I2612-4400.....114	I2671-3911.....113	N2400-4107.....128
<b>I</b>	I1400-0808.....69	I2350-5841.....101	I2612-4500.....114	I2671-3912.....113	N2400-4108.....128
I1016-0400.....30	I1400-0900.....69	I2350-5842.....101	I2612-4600.....114	I2671-3913.....113	N2400-6000.....130
I1016-0410.....30	I1400-1008.....60	I2350-5843.....101	I2612-4700.....114	I2671-3914.....113	N2400-6001.....130
I1016-0810.....30	I1400-1200.....69	I2350-5844.....101	I2612-5000.....118	I2671-3915.....113	N2400-6002.....130
I1051-0000.....21	I1400-1208.....69	I2350-5846.....101	I2612-5300.....114	I2671-3916.....113	N2400-6003.....130
I1051-0350.....21	I1400-1290.....69	I2350-5848.....101	I2612-5400.....114	I2671-3917.....113	N2400-6004.....130
I1051-0360.....21	I1402-0400.....71	I2381-1025.....100, 104	I2612-5500.....114	I2671-3922.....116	N2400-7000.....127
I1052-0028.....21	I1402-1200.....69	I2381-2305.....104	I2612-5600.....114	I2671-3923.....116	N2400-7001.....127
I1008-9000.....20	I1402-1208.....69	I2381-5040.....100	I2612-6000.....118	I2671-3924.....116	N2400-7002.....127
I1010-3000.....23	I1402-2700.....70	I2381-5041.....100	I2612-7000.....118	I2671-3925.....116	N2400-7003.....127
I1010-3600.....23	I1402-2800.....70	I2381-5042.....100	I2612-8000.....118	I2671-5013.....113	N2520-3200.....125
I1010-3610.....23	I1402-2900.....70	I2381-5043.....100	I2612-9000.....118	I2671-5018.....113	N2520-4800.....125
I1010-3800.....23	I1402-2908.....70	I2381-5044.....100	I2613-1000.....118	I2671-5020.....113	N2530-1500.....125
I1011-0020.....19	I1402-3500.....69	I2381-5046.....100	I2613-1100.....118	I2671-7211.....113	N2530-8200.....125
I1011-0830.....19	I1402-3508.....69	I2381-5048.....100	I2613-1200.....118	I2671-7814.....113	N2530-8300.....125
I1011-0920.....19	I1402-3509.....69	I2381-5049.....100	I2613-1300.....118	I2672-7811.....113	N2540-8400.....125
I1011-2600.....23	I1402-3700.....71	I2396-5048.....107	I2613-2000.....118	I2672-7812.....113	N2540-8500.....125
I1011-3000.....19	I1402-3800.....71	I2396-5099.....107	I2613-3000.....118	I2672-7813.....113	N2631-0007.....132
I1011-3010.....19	I1402-4300.....68	I2510-5005.....104	I2613-5000.....118	I2672-7814.....113	N2631-0008.....131
I1011-4600.....23	I1402-4308.....68	I2602-1000.....118	I2613-6000.....118	I2672-7815.....113	N2631-0018.....131
I1011-5830.....19	I1402-4700.....69	I2602-1100.....118	I2613-7000.....118	I2672-7816.....113	N3000-0000.....95
I1011-8000.....22	I1402-5700.....69	I2602-1200.....118	I2613-8000.....118	I2672-7821.....116	N3000-0001.....95
I1012-2600.....23	I1402-8100.....68	I2602-1300.....118	I2613-9000.....118	I2672-7822.....116	N3795-4391.....95, 96
I1012-3600.....23	I1402-8108.....68	I2602-1325.....119	I2615-1000.....116	I2672-7823.....116	N3795-4392.....95, 96
I1012-3610.....23	I1402-8200.....68	I2602-3000.....118	I2615-2600.....116	I2672-7824.....116	N3795-4393.....95, 96
I1012-4600.....23	I1402-9700.....74	I2602-3081.....119	I2615-3600.....116	I2928-7355.....86	N3795-4394.....95, 96
I1012-6400.....20	I1402-9708.....74	I2602-3300.....114	I2615-5000.....116	I3080-0001.....86	N3795-4396.....95, 96
I1012-6410.....20	I1402-9709.....74	I2602-3400.....114	I2632-3300.....115	I3080-0002.....86	N3795-4399.....95, 96
I1015-6810.....18	I1402-9800.....74	I2602-3500.....114	I2632-3400.....115	I3080-0004.....86	N3795-4619.....95, 96
I1015-6810-C.....18	I1402-9800-BC.....73	I2602-4081.....119	I2632-3500.....115	I3080-0500.....86	N3942-7000.....125
I1016-0400-C.....30	I1402-9809.....74	I2602-4300.....114	I2632-4400.....115	I3080-1075.....86	N3942-7500.....125
I1016-0410-C.....30	I1402-9909.....74	I2602-4400.....114	I2632-4500.....115	I3080-1075.....86	N3952-7018.....125
I1016-0810-C.....30	I1402-9909-BC.....73	I2602-4500.....114	I2632-4600.....115	I3080-5075.....86	N3952-7518.....125
I1022-0000.....23	I1405-1500.....59	I2602-4600.....114	I2632-4700.....115	I6308-1515.....112	N5127-4619.....95, 96
I1022-0600.....23	I1405-1507.....59	I2602-4700.....114	I2632-5300.....115	I6342-4270.....112	N7519-4889.....95, 96
I1022-0610.....23	I1405-4390.....60	I2602-5000.....118	I2632-5400.....115	I6348-1515.....112	NPG-INT-M.....138
I1022-0810.....23	I1405-8100.....68	I2602-5081.....119	I2632-5500.....115	I9023-1615.....99	NPG-INT-L.....138
I1022-2600.....23	I1405-8108.....68	I2602-5300.....114	I2632-5600.....115	I9023-1650.....99	NPG-INT-S.....138
I1022-4600.....23	I1405-8200.....68	I2602-5400.....114	I2650-2600.....116		NPG-INT-XL.....138
I1026-7800.....19	I1405-8208.....68	I2602-5500.....114	I2650-3600.....116	<b>N</b>	NPG-INT-XS.....138
I1026-7810.....19	I1409-2700.....71	I2602-5600.....114	I2652-1120.....117	N0072-4619.....96	
I1050-0000.....21	I1409-3700.....71	I2602-6000.....118	I2652-2000.....117	N0074-4619.....96	
I1050-0700.....21	I1409-3800.....71	I2602-6081.....119	I2652-3000.....117	N0081-4889.....96	
I1050-0710.....21	I1409-4700.....69, 71	I2602-7000.....118	I2652-4500.....117	N0082-4993.....96	
				N0082-4996.....96	
					<b>P</b>
					P1112-0021.....56
					P1112-0101.....56
					P1112-0201.....56

# Index by Catalogue Number

P1112-1001 .....56	R1081-3709 .....31, 34	S1111-0000-C .....12	S1111-3701-C .....13	S1182-1830 .....17	S7200-0000 .....43
P1112-1101 .....56	R1081-5700 .....31, 34	S1111-0006 .....12	S1111-3800 .....12	S1182-1830-C .....17	S9999-0002 .....13
P1112-1501 .....56	R1081-5709 .....31, 34	S1111-0006-C .....12	S1111-3800-C .....12	S1602-2900 .....70	SL02-16AZ .....44
P1112-2001 .....56	R1128-0810 .....31, 34	S1111-0200 .....13	S1111-3810 .....12	S1602-4300 .....68	SL02-FZ-2 .....44
P1122-0021 .....56	R1128-0819 .....31, 34	S1111-0200-C .....13	S1111-3810-C .....12	S1605-0000 .....58	SL10-12AZ .....44
P1122-0101 .....56	R1128-2810 .....31, 32, 34	S1111-0206 .....13	S1111-4000 .....12	S1605-0099 .....58	SL10-16AZ .....44
P1122-0201 .....56	R1128-2819 .....31, 32, 34	S1111-0206-C .....13	S1111-4000-C .....12	S1615-5500 .....58	SL10-8AZ .....44
P1122-1001 .....56	R1128-3810 .....31, 34	S1111-0210 .....13	S1111-4800 .....12	S1615-5510 .....58	SL10-FZ-10 .....44
P1122-1101 .....56	R1128-3819 .....31, 34	S1111-0210-C .....13	S1111-4800-C .....12	S1615-5550 .....58	SL200-12AZ .....44
P1122-1501 .....56	R1128-5810 .....31, 34	S1111-0700 .....13	S1111-4810 .....12	S1615-5599 .....58	SL200-8AZ .....44
P1122-2001 .....56	R1128-5819 .....31, 34	S1111-0700-C .....13	S1111-4810-C .....12	S1620-2700 .....58	SL200-FZ-200 .....44
P1132-0021 .....56	R1129-1810 .....36	S1111-0706 .....13	S1112-1020 .....12	S1620-2799 .....58	SL300-12AZ .....44
P1132-0101 .....56	R1129-1810-C .....36	S1111-0800 .....12	S1112-1020-C .....12	S1823-8400 .....83	SL300-8AZ .....44
P1132-0201 .....56	R1181-0700 .....31, 34	S1111-0800-C .....12	S1112-1720 .....13	S1823-8410 .....83	SL300-FZ-300 .....44
P1132-1001 .....56	R1181-0709 .....31, 34	S1111-0806 .....12	S1112-1720-C .....13	S1830-9600 .....83	SL50-12AZ .....44
P1132-1101 .....56	R1181-2700 .....31, 32, 34	S1111-0806-C .....12	S1112-1721 .....13	S1830-9610 .....83	SL50-16AZ .....44
P1132-2001 .....56	R1181-2709 .....31, 32, 34	S1111-0810 .....12	S1112-1721-C .....13	S1833-9600 .....83	SL50-8AZ .....44
P1142-0021 .....56	R1181-3700 .....31, 34	S1111-0810-C .....12	S1112-1820 .....12	S1833-9610 .....83	SL50-FZ-50 .....44
P1142-0101 .....56	R1181-3709 .....31, 34	S1111-0816 .....12	S1112-1820-C .....12	S1837-9600 .....83	SP-INT-M .....136
P1142-0201 .....56	R1181-5700 .....31, 34	S1111-0816-C .....12	S1112-1830 .....12	S1837-9610 .....83	SP-INT-L .....136
P1142-1001 .....56	R1181-5709 .....31, 34	S1111-1000 .....12	S1112-1830-C .....12	S1843-8400 .....83	SP-INT-S .....136
P1142-1101 .....56	R1188-1700 .....36	S1111-1000-C .....12	S1120-1810 .....15	S1843-8410 .....83	SP-INT-XL .....136
P1142-2001 .....56	R1188-1700-C .....36	S1111-1006 .....12	S1120-1810-C .....15	S1884-2000 .....79	SU-INT-M .....136
P1151-0021 .....56		S1111-1006-C .....12	S1120-1840 .....15	S1884-2400 .....79	SU-INT-L .....136
P1151-0101 .....56	<b>S</b>	S1111-1200 .....13	S1120-1840-C .....15	S1884-2410 .....79	SU-INT-S .....136
P1151-0201 .....56	S0000-0002 .....13	S1111-1200-C .....13	S1120-2810 .....15	S1896-1000 .....79	SU-INT-XL .....136
P1151-1001 .....56	S1110-1000 .....12	S1111-1206 .....13	S1120-2810-C .....15	S1896-1110 .....79	SU-INT-XS .....136
P1151-1101 .....56	S1110-1000-C .....12	S1111-1206-C .....13	S1120-3810 .....15	S1896-1800 .....79	SYP-INT-S .....138
P1151-2001 .....56	S1110-1006 .....12	S1111-1210 .....13	S1120-3810-C .....15	S1896-2000 .....79	SYP-INT-M .....138
P1162-0001 .....56	S1110-1006-C .....12	S1111-1210-C .....13	S1120-8810 .....15	S1896-2110 .....79	SYP-INT-L .....138
P1191-5000 .....56	S1110-1200 .....13	S1111-1700 .....13	S1120-8810-C .....15	S1896-2800 .....79	SYP-INT-XL .....138
P2131-0002 .....46	S1110-1200-C .....13	S1111-1700-C .....13	S1120-9810 .....15	S1896-5000 .....79	
P2311-1001 .....55	S1110-1206 .....13	S1111-1701 .....13	S1120-9810-C .....15	S1896-5110 .....79	<b>T</b>
P2311-1101 .....55	S1110-1206-C .....13	S1111-1701-C .....13	S1121-3810 .....15	S1896-5800 .....79	TM301 .....140
P2311-2001 .....55	S1110-1700 .....13	S1111-1706 .....13	S1121-3810-C .....15	S4026-1500 .....48	TM301-C .....140
P2331-0021 .....55	S1110-1700-C .....13	S1111-1706-C .....13	S1121-4810 .....15	S4026-1525 .....24	TM305 .....140
P2331-0101 .....55	S1110-1800 .....12	S1111-1800 .....12	S1121-4810-C .....15	S4026-1525 .....48	TM305-C .....140
P2331-0201 .....55	S1110-1800-C .....12	S1111-1800-C .....12	S1122-1830 .....15	S4026-5806 .....88	TM308 .....140
P2331-0211 .....55	S1110-1806 .....12	S1111-1806 .....12	S1122-1830-C .....15	S4770-0050 .....24	TM308-C .....140
P2331-1001 .....55	S1110-1806-C .....12	S1111-1806-C .....12	S1160-3700 .....17	S4772-0125 .....24	TM309 .....140
P2331-1101 .....55	S1110-1810 .....12	S1111-1810 .....12	S1160-3700-C .....17	S4774-0250 .....24	TM309-C .....140
P2331-1501 .....55	S1110-1810-C .....12	S1111-1810-C .....12	S1160-3800 .....17	S4776-0500 .....24	TM351 .....140
P2331-2001 .....55	S1110-1816 .....12	S1111-1816 .....12	S1160-3800-C .....17	S4778-1250 .....24	TM353 .....140
P2351-0021 .....55	S1110-1816-C .....12	S1111-1816-C .....12	S1160-9700 .....17	S4780-2500 .....24	TM353-C .....140
P2351-0101 .....55	S1110-3000 .....12	S1111-2020 .....12	S1160-9700-C .....17	S4782-5000 .....24	TRO21 .....140
P2351-0211 .....55	S1110-3000-C .....12	S1111-2020-C .....12	S1160-9800 .....17	S4784-0050 .....24	
P2351-1001 .....55	S1110-3700 .....13	S1111-2021 .....12	S1160-9800-C .....17	S4786-0125 .....24	<b>U</b>
P2351-1101 .....55	S1110-3700-C .....13	S1111-2021-C .....12	S1161-1700 .....17	S4788-0250 .....24	US-INT-L .....137
P2351-1501 .....55	S1110-3800 .....12	S1111-2720 .....13	S1161-1700-C .....17	S4790-0500 .....24	US-INT-M .....137
P2351-2001 .....55	S1110-3800-C .....12	S1111-2720-C .....13	S1161-1720 .....17	S4792-1250 .....24	US-INT-S .....137
P2391-1001 .....55	S1110-3810 .....12	S1111-2721 .....13	S1161-1720-C .....17	S4794-2500 .....24	US-INT-XL .....137
P2391-1101 .....55	S1110-3810-C .....12	S1111-2721-C .....13	S1161-1800 .....17	S4796-5000 .....24	US-INT-XS .....137
P2391-1501 .....55	S1110-8000 .....12	S1111-2820 .....12	S1161-1800-C .....17	S5000-7000 .....11	USP-INT-M .....137
P2421-1001 .....55	S1110-8000-C .....12	S1111-2820-C .....12	S1161-1820 .....17	S5000-7200 .....11	USP-INT-L .....137
	S1110-8700 .....13	S1111-2821 .....12	S1161-1820-C .....17	S5000-7600 .....11	USP-INT-S .....137
<b>R</b>	S1110-8700-C .....13	S1111-2821-C .....12	S1161-3700 .....17	S7100-0125 .....42	USP-INT-XL .....137
R1028-0810 .....31, 34	S1110-8800 .....12	S1111-2830 .....12	S1161-3700-C .....17	S7100-0220 .....42	USP-INT-XS .....137
R1028-0819 .....31, 34	S1110-8800-C .....12	S1111-2830-C .....12	S1180-1810 .....17	S7100-0221 .....42	
R1028-2810 .....31, 32, 34	S1110-8810 .....12	S1111-2831 .....12	S1180-1810-C .....17	S7100-0510 .....42	<b>X</b>
R1028-2819 .....31, 32, 34	S1110-8810-C .....12	S1111-2831-C .....12	S1180-1840 .....17	S7100-1100 .....42	XC-INT-M .....136
R1028-3810 .....31, 34	S1110-9000 .....12	S1111-3000 .....12	S1180-1840-C .....17	S7100-2200 .....42	XC-INT-L .....136
R1028-3819 .....31, 34	S1110-9000-C .....12	S1111-3000-C .....12	S1180-3810 .....17	S7108-0510 .....43	XC-INT-S .....136
R1028-5810 .....31, 34	S1110-9700 .....13	S1111-3200 .....13	S1180-3810-C .....17	S7108-1100 .....43	XC-INT-XL .....136
R1028-5819 .....31, 34	S1110-9700-C .....13	S1111-3200-C .....13	S1180-8810 .....17	S7108-3300 .....43	XC-INT-XS .....136
R1081-0700 .....31, 34	S1110-9800 .....12	S1111-3210 .....13	S1180-8810-C .....17	S7110-1000 .....42	
R1081-0709 .....31, 34	S1110-9800-C .....12	S1111-3210-C .....13	S1180-9810 .....17	S7112-0510 .....43	
R1081-2700 .....31, 32, 34	S1110-9810 .....12	S1111-3700 .....13	S1180-9810-C .....17	S7112-1100 .....43	
R1081-2709 .....31, 32, 34	S1110-9810-C .....12	S1111-3700-C .....13	S1181-3810 .....17	S7112-3300 .....43	
R1081-3700 .....31, 34	S1111-0000 .....12	S1111-3701 .....13	S1181-3810-C .....17	S7150-5000 .....42	





[www.starlabgroup.com](http://www.starlabgroup.com)

**STARLAB (UK), Ltd**

4 Tanners Drive  
Milton Keynes MK14 5NA  
United Kingdom

T: +44 (0)1908 283800  
F: +44 (0)1908 283802  
infoline@starlab.co.uk  
www.starlab.co.uk

**STARLAB International GmbH**

Neuer Höltingbaum 38  
22143 Hamburg  
Germany

T: +49 (0)40 675 99 39 0  
F: +49 (0)40 675 99 39 20  
info@starlab.de  
www.starlabgroup.com

**STARLAB GmbH**

Neuer Höltingbaum 38  
22143 Hamburg  
Germany

T: +49 (0)40 675 99 39 0  
F: +49 (0)40 675 99 39 20  
info@starlab.de  
www.starlab.de

**STARLAB FRANCE SARL**

38 Avenue Henri Barbusse  
92220 Bagneux  
France

T: +33 (0)1 45 3652 80  
F: +33 (0)1 45 3604 86  
info@starlab-france.com  
www.starlabgroup.com

**STARLAB S.r.l.**

Via Corelli 36/5  
20134 Milano  
Italy

T: +39 02 7020 1040  
F: +39 02 7020 1033  
info@starlabitalia.it  
www.starlabitalia.it