

fixing

There are 3 different methods to wall or surface mount these panel fixings.

The **Micro, Mini and Maxi** fixings may be secured by METHOD 1 only.

Fixings **PSD.1 - PSD.5** and **PE.1 - PE.6** may be secured by METHODS 2 or 3 only.

Please state your preference at time of order.

METHOD 1 - SCREW FIXED

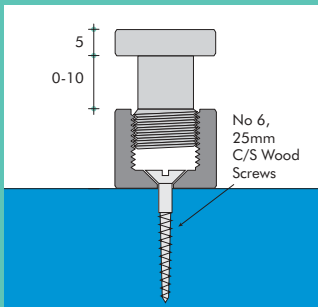

For fixing **Micro 15.35, Mini 15.27** and **Maxi 3.26**.

METHOD 2 - BOLT FIXED

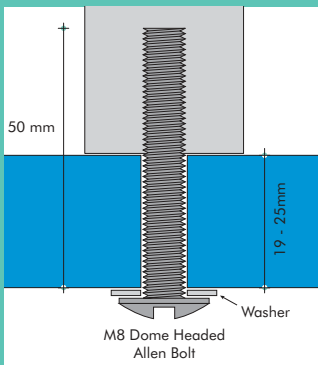

Fixings **PSD.1 - PSD.5** and **PE.1 - PE.6** can be fixed on to M8 bolt or stud fixing.

METHOD 3 - OLIVE FIXED

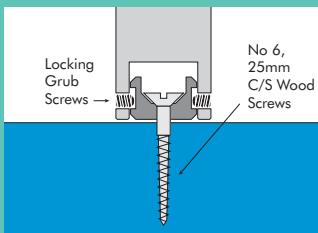

Fixings **PSD.1 - PSD.5** and **PE.1 - PE.6** may also be fixed using this alternative method.

panel fixings

signage

counter tops

glass

solid panels

SHOPKIT DESIGNS LIMITED

100 Cecil Street, Watford, Hertfordshire
WD24 5AD England

Tel: 01923 818282 Fax: 01923 818280

email: sales@shopkit.com

www.shopkit.com

SHOPKIT
DESIGNS LIMITED

www.shopkit.com

panel fixings

Shopkit introduces two new ranges of high quality panel fixings to our existing components range.

They provide an easy method to wall-mount sign panels, or create a raised counter top.

2 methods of fixing the panel are provided: either by clamping *through* the panel with holes drilled accordingly, or by clamping the edge of the panel.

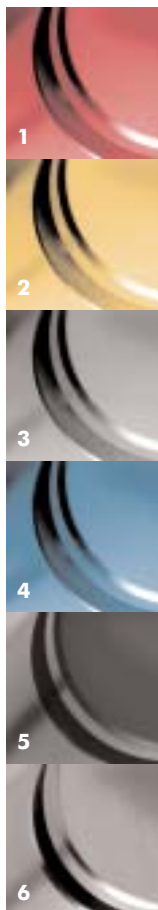

A wide variety of materials and finishes are offered, with other finishes available to special order.

Pick a colour:

- 1 red anodised aluminium
- 2 gold anodised aluminium
- 3 satin anodised aluminium
- 4 blue anodised aluminium
- 5 black anodised aluminium
- 6 satin/mirror polished stainless steel



Standard sizes are available in either version, with other sizes available to special order.



Optional
Vandal Proof
fixing head

panel supports

for drilled sheets



Micro 15.35

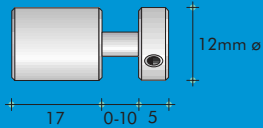

Mini 15.27

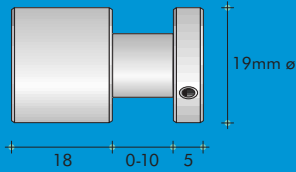

Maxi 3.26

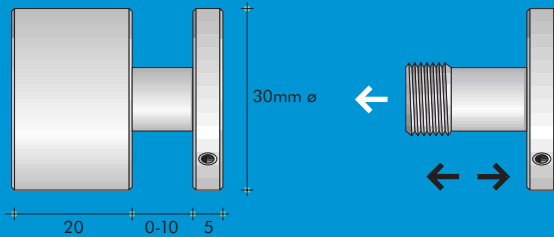

PSD.4 in satin anodised aluminium, clamped through 8mm toughened glass



optional Vandal Proof fixing head

These **panel supports** provide an easy method to wall-mount sign panels, or create a raised counter top, and can be produced to hold glass or solid panels up to 25mm thick.

The **Micro** wall fixed panel support holds panels up to 10mm thick and screws down to zero. Panels require drilling with 9mm holes.

The **Mini and Maxi** wall fixed panel supports hold panels between 0-10mm thick. Panels require drilling with 13mm holes.

The standard size components **PSD.1 to PSD.5** (inclusive) will hold panels between 6mm and 10mm thick. Panels of up to 25mm thick can be accommodated by specifying made-to-order versions of components PSD.1 to PSD.5.

The size of the hole required to be drilled in the panel will depend on its thickness - please contact our technical department on 01923 818282 to discuss further.

Tightening down onto the panel material is aided by the small hole on the side of the top button: **see diagrams left** - or choose the Vandal Proof option **see photograph above**.

6 material and colour finishes are available (see introduction page for details) with specials available on request.

The **Micro, Mini and Maxi** panel supports are wall / surface mounted via fixing METHOD 1. Panel supports **PSD.1 - PSD.5** may be fixed by METHODS 2 or 3 only. See **back cover** for details.

PSD.1

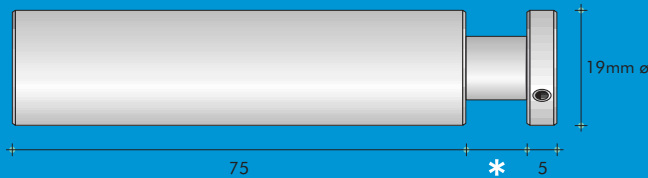

PSD.2

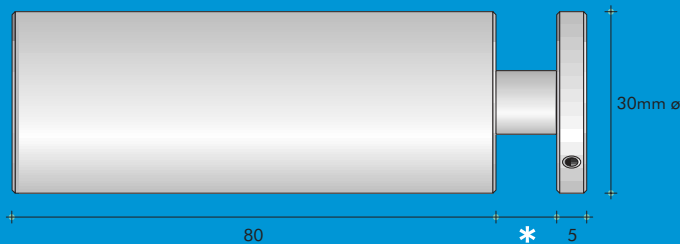

PSD.3

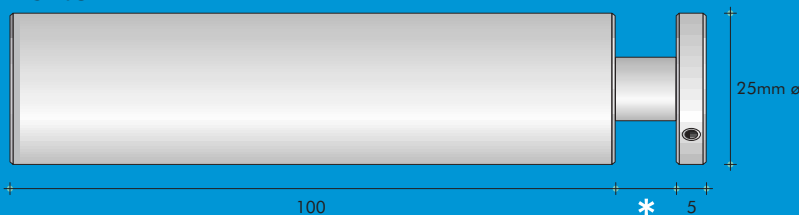

PSD.4

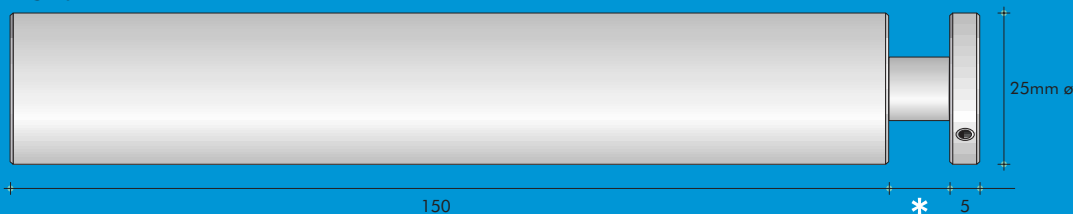

PSD.5

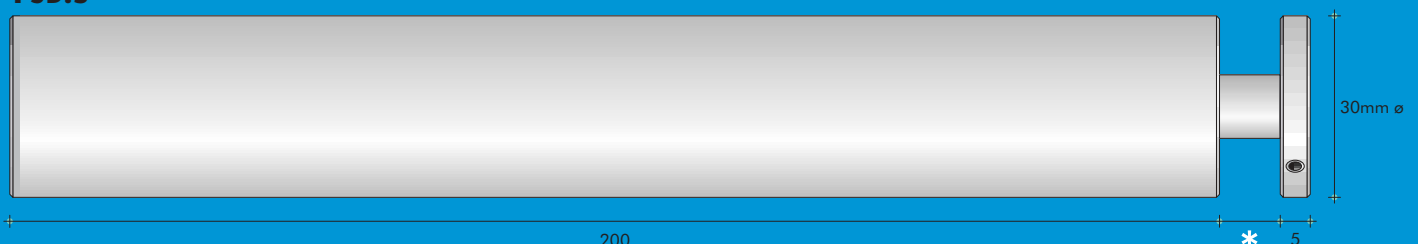

* STANDARD SIZE WILL HOLD PANELS BETWEEN 6MM AND 10MM THICK
FIXINGS CAN BE SUPPLIED FOR PANELS OF UP TO 25MM THICK ON A MADE-TO-ORDER BASIS

edge fixed panel supports



PE.4 in chrome

PE.1*

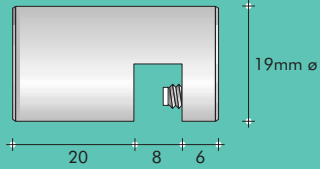

PE.2

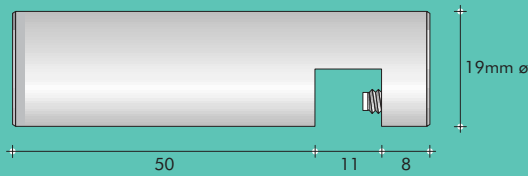

PE.3



PE.4

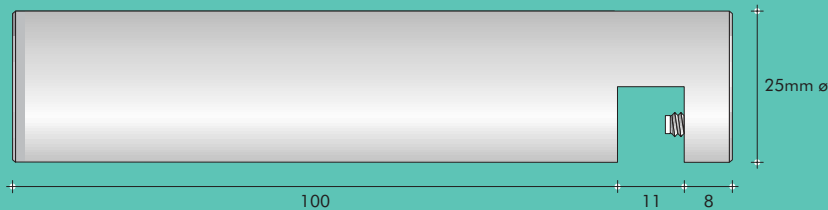

PE.5

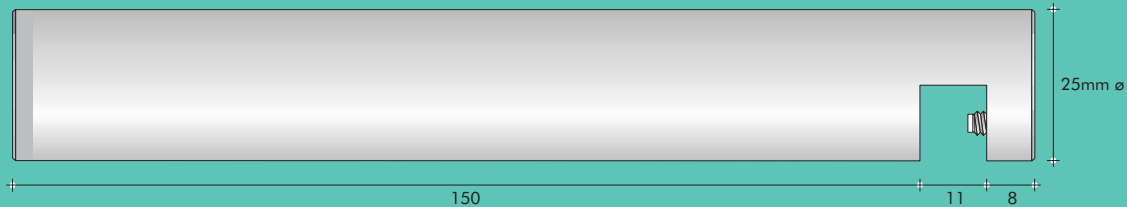

PE.6

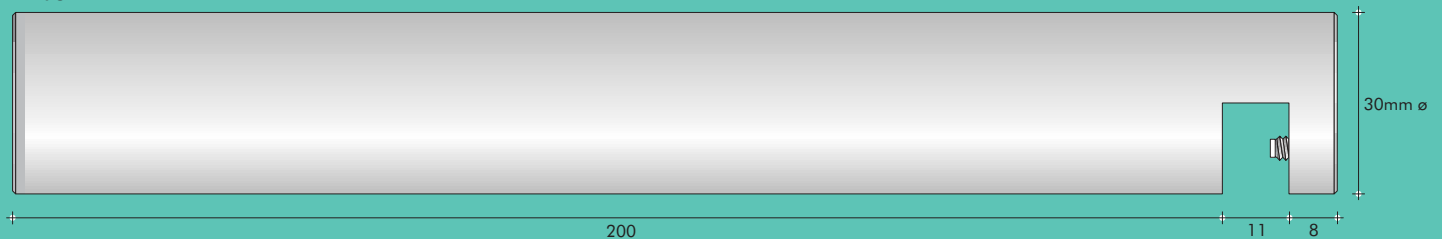

The nylon-tipped grub screw in components **PE.2 to PE.6** (inclusive) is designed to hold panels **6-10mm** thick.

*Please note that component **PE.1** will hold panels between **3-6mm** thick.

These **edge fixed panel supports** provide an easy method to wall-mount sign panels, or create a raised counter top, they are designed for glass or solid panels ranging in thickness from **3 - 10mm** depending on which component is used. IF DOUBT CHECK WITH THE TECHNICAL SUPPORT TEAM ON 01923 818282

6 material and colour finishes are available (see **introduction page for details**) with specials available on request.

These **edge fixed panel supports** may be fixed using **METHODS 2 or 3** only: See **back cover** for details.

