

COMPONENTS

THE DEFINITIVE RANGE
CABLE + ROD ACCESSORIES
PANEL + SHELF FIXINGS

1.5 mm CABLE

3 mm CABLE

6.0 mm ROD

12.0 mm ROD

TRACK

FIN

PANEL FIXINGS

SHELF FIXINGS

LIGHTING

ACRYLICS

ACCESSORIES

COMPOC

ONENENTS

COMPONENTS

The Shopkit Group designs, manufactures and distributes the most comprehensive range of components available for tensioned cables, rods, panel fixing and glass supports. While this brochure illustrates our standard product range, Shopkit can both assist with design and then manufacture a component that is not included in the standard range. Working with the highest quality materials Shopkit's commitment to quality is second to none, whether working in stainless steel, brass or aluminium our fabrications and engineering works use state of the art machines to ensure the excellent finish that Shopkit products are renowned for.

Shopkit has showrooms in the UK, Europe and US where our products can be seen and any questions answered by our technical sales personnel. Our full product range can be viewed on our website – www.shopkit.com or visit our e.commerce site on <http://shop.shopkit.com> for the best prices on the best product.



“Should a particular requirement not be met by the existing product range Shopkit offer a bespoke design and manufacturing service to meet individual needs.”

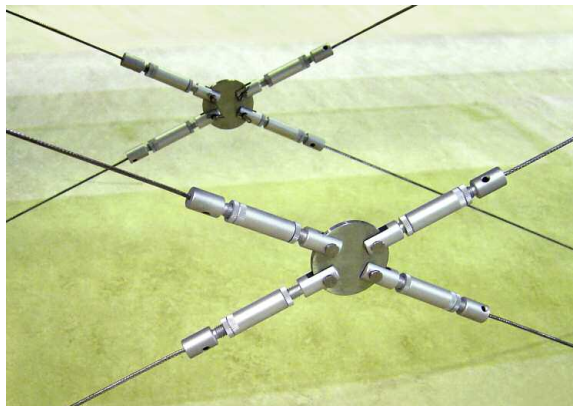

Contents

- 01** Cable setups
- 03** Mini Cable 1.5mm
- 09** Maxi Cable 3mm
- 13** Rod 6mm
- 17** Rod 12mm
- 21** Fin Mini and Maxi Shelving
- 23** Panel Supports
- 27** Glass Supports
- 31** Lighting
- 35** Point of Sale
- 37** Banners
- 39** Acrylics
- 40** Accessories

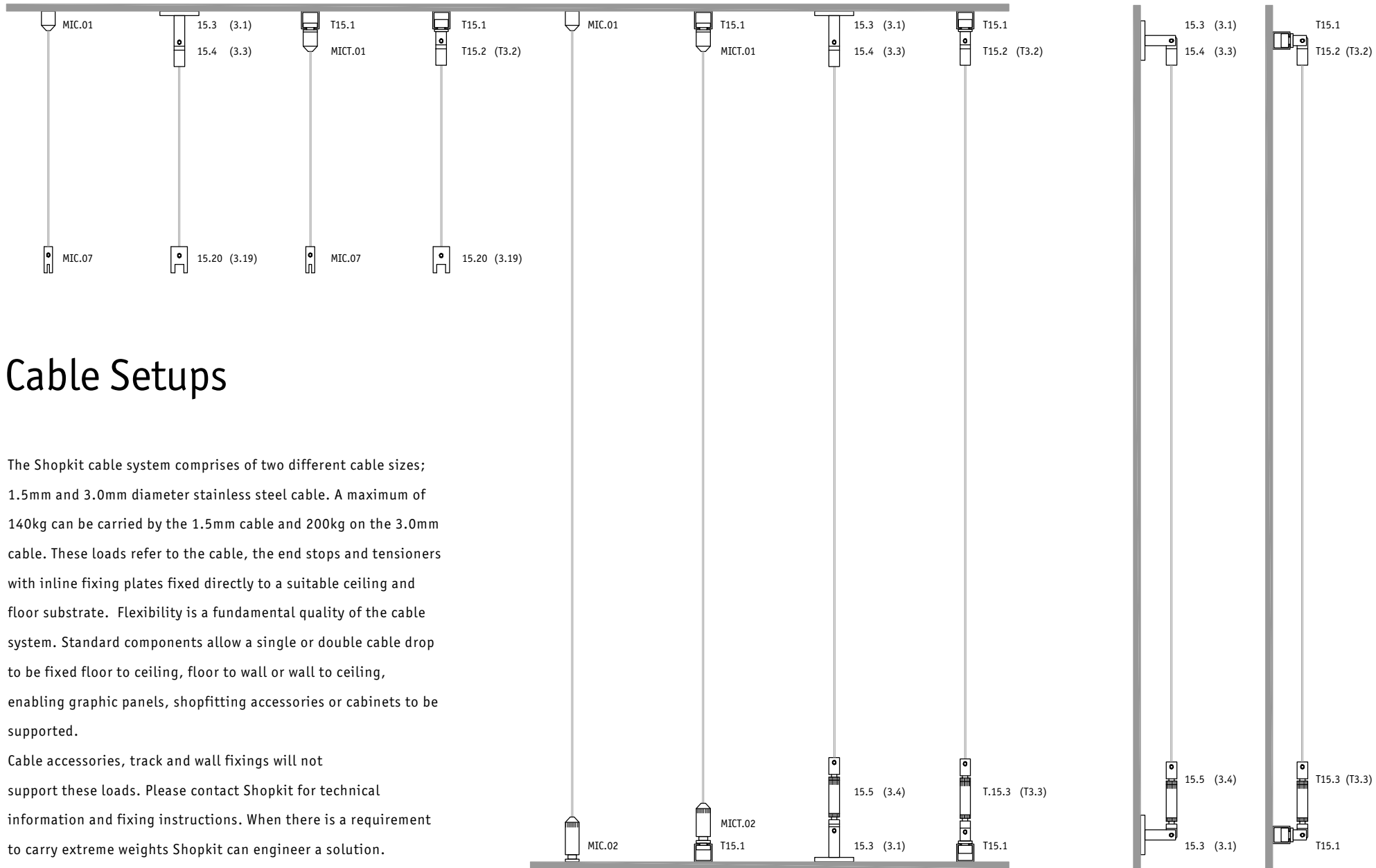

Cable Setups

The Shopkit cable system comprises of two different cable sizes; 1.5mm and 3.0mm diameter stainless steel cable. A maximum of 140kg can be carried by the 1.5mm cable and 200kg on the 3.0mm cable. These loads refer to the cable, the end stops and tensioners with inline fixing plates fixed directly to a suitable ceiling and floor substrate. Flexibility is a fundamental quality of the cable system. Standard components allow a single or double cable drop to be fixed floor to ceiling, floor to wall or wall to ceiling, enabling graphic panels, shopfitting accessories or cabinets to be supported.

Cable accessories, track and wall fixings will not support these loads. Please contact Shopkit for technical information and fixing instructions. When there is a requirement to carry extreme weights Shopkit can engineer a solution.

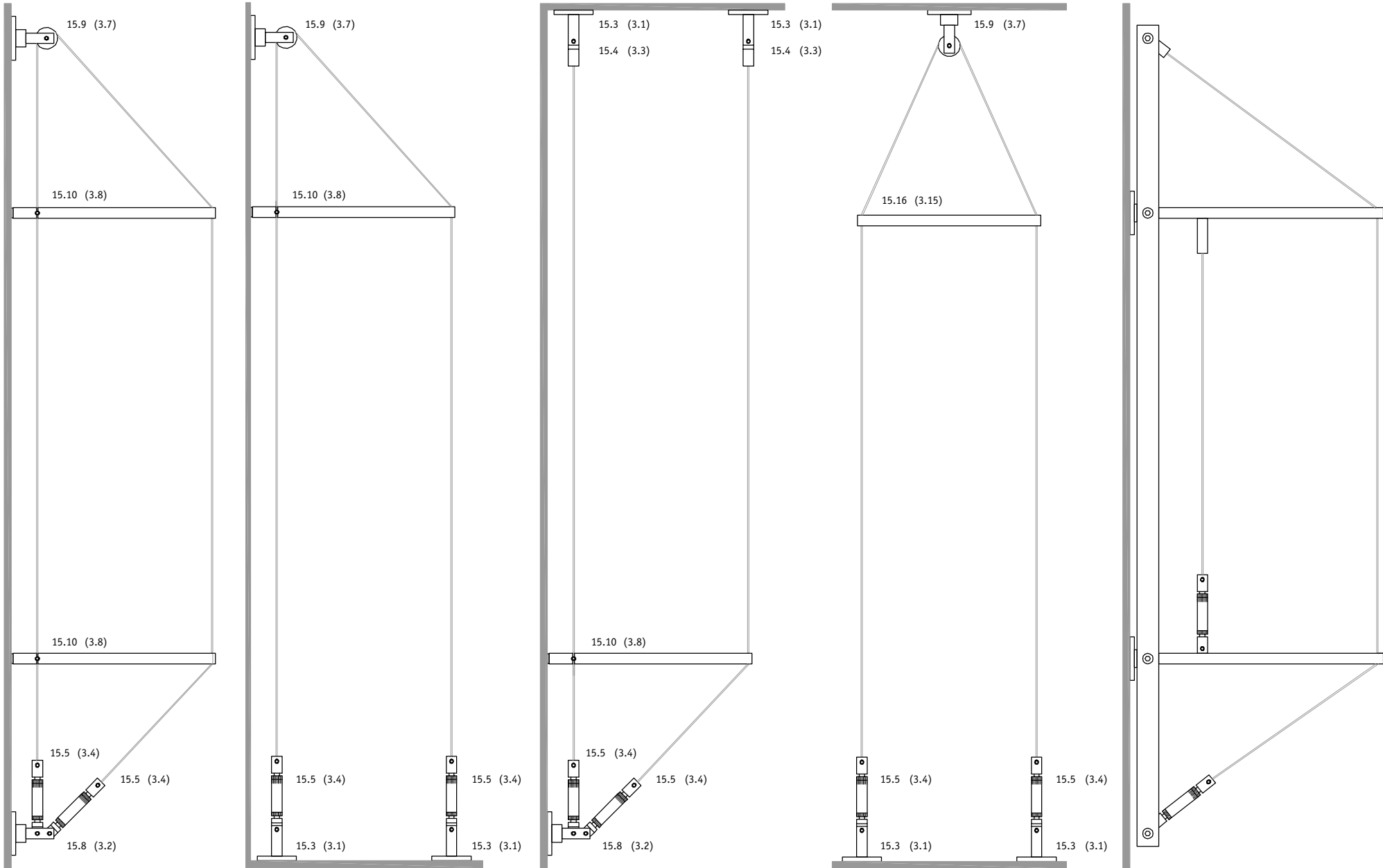

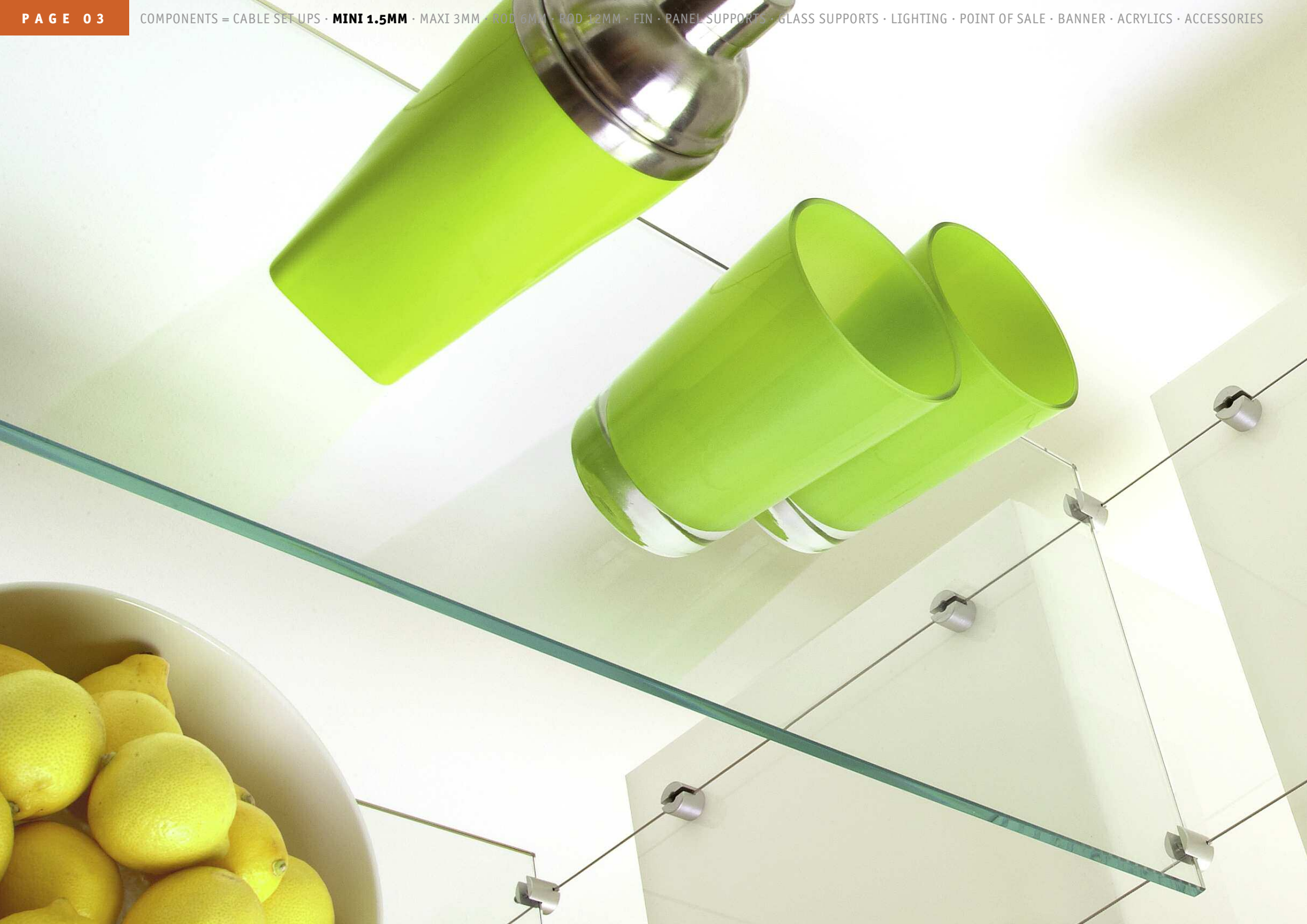



Mini Cable 1.5mm

The Mini system is based on a 1.5mm diameter stainless steel cable and when correctly installed between ceiling and floor the maximum load on each cable assembly is 140kg.

For light weight displays and graphic panels the Mini system offers a Micro tensioner (MIC.02) and end stop (MIC01) which are available as individual components or as cable kits. The standard Mini tensioner (15.5) and end stop (15.4) offer greater load capacity (140kg) and are supplied as individual components only.

All components are supplied as standard in satin anodised aluminium but are also available in brass, chromed brass and stainless steel. A full range of accessories from acrylic, graphic and brochure holders, to shelving and retail equipment are available.

Instruction for installation as well as technical advice is available from any of the Shopkit showrooms or website.



Mini Cable 1.5mm

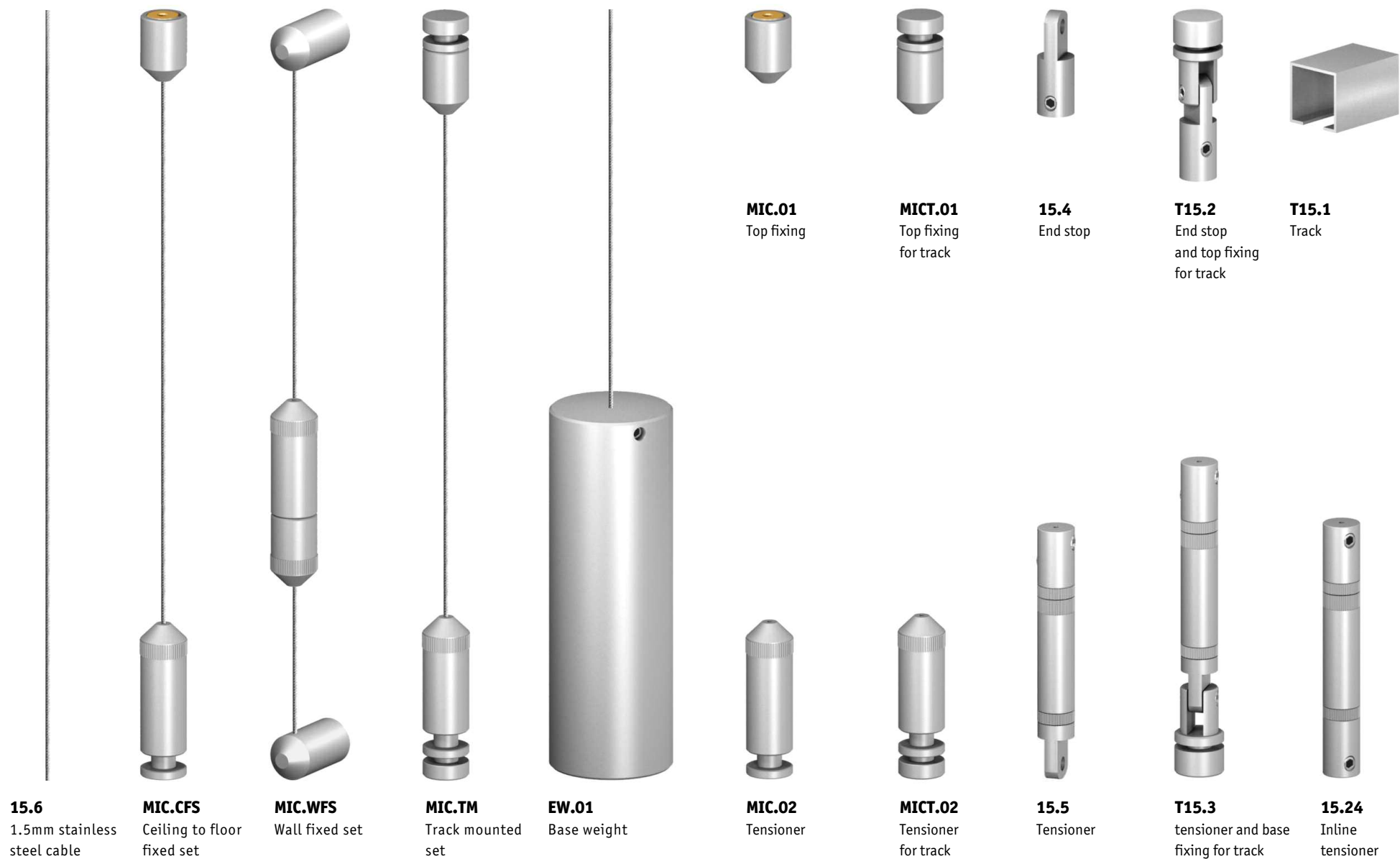

Mini Cable 1.5mm



MIC.05
Single sided 3mm
glass shelf support



MIC.06
Double sided 3mm
glass shelf support



15.34
Single sided 6mm
glass shelf support



15.32
Double sided 6mm
glass shelf support



15.18
Single sided 10mm
glass shelf support



15.26
Double sided 10mm
glass shelf support



MIC.03
Single sided 3mm
picture/panel grip



MIC.04
Double sided 3mm
picture/panel grip



15.28
Single sided 6mm
picture/panel grip



15.29
Double sided 6mm
picture/panel grip



15.13
Single sided 10mm
picture/panel grip



15.14
Double sided 10mm
picture/panel grip



15.3
Fixing plate

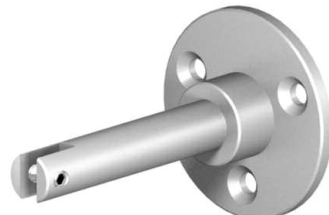

15.25
Extended fixing plate



15.8
Twin fixing plate



15.9
Pulley wheel fixing plate

Mini Cable 1.5mm



15.19

Single sided timber panel or shelf support



15.31

Wall fixed shelf/panel grip



15.30

Swivel grip for shelves



15.11

general purpose support



15.12

Shelf support



15.30

Swivel grip for panels



MIC.07

3mm top edge grip



15.33

6mm top edge grip



15.20

10mm top edge grip



15.22

Picture hook



15.23

Panel support

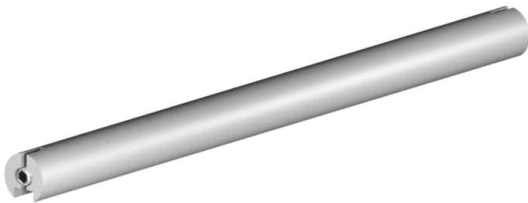

15.21

Continuous channel, various lengths

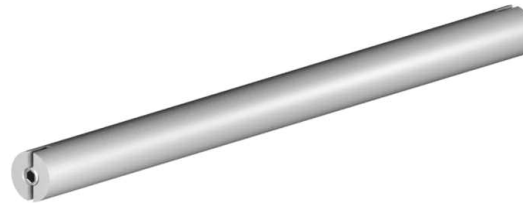

15.16

Spacer bar, 200mm cable centres

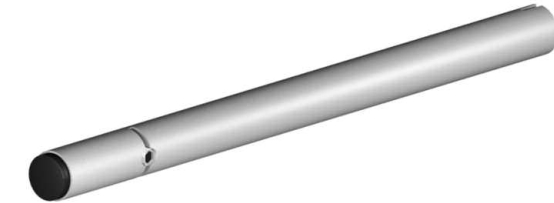

15.10

Spacer rod, 200mm cable centres

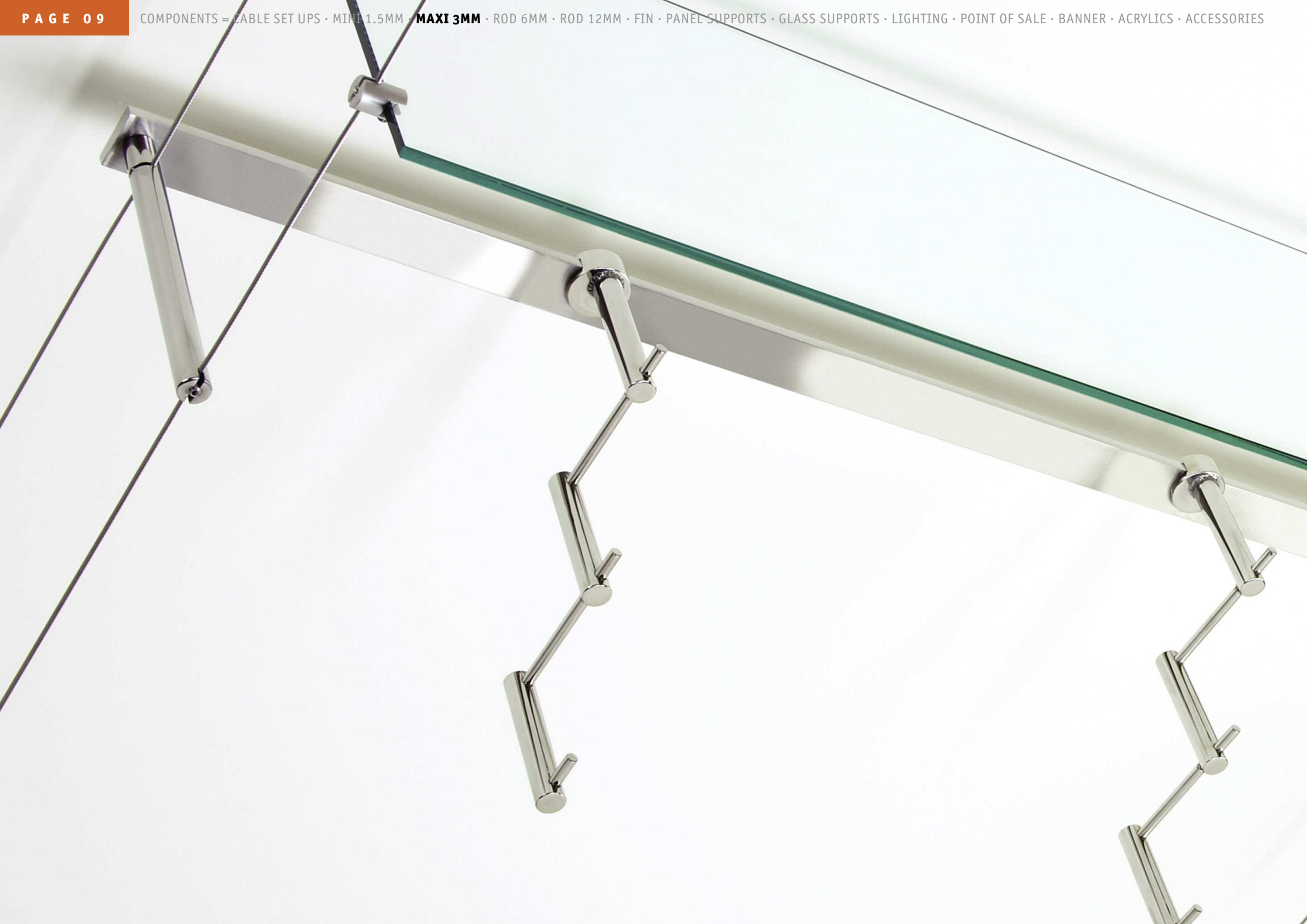

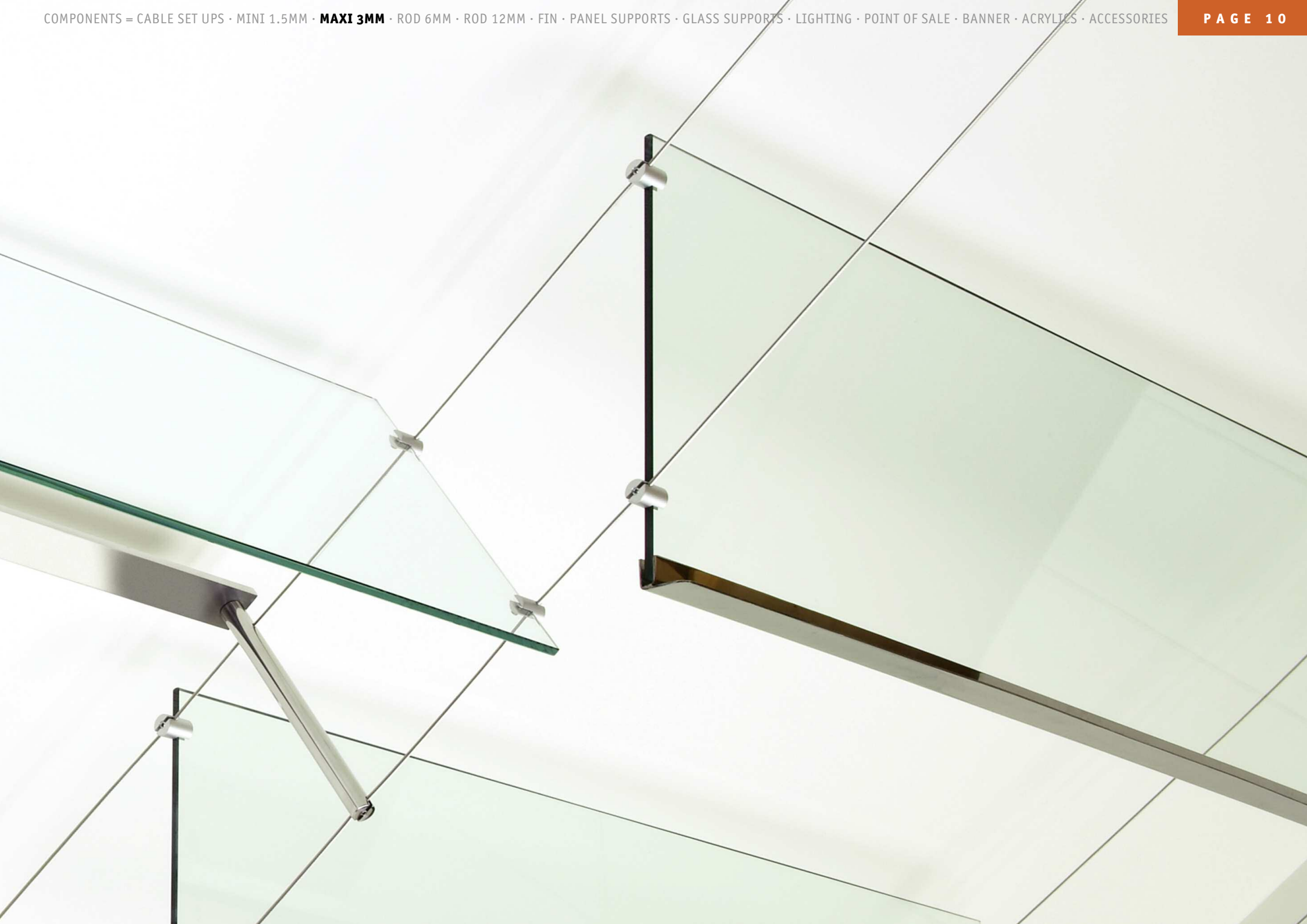

Maxi Cable 3mm

The Maxi system is based on a 3.0mm diameter stainless steel cable with slightly larger components than the Mini system, the Maxi system offers an increased loading on each cable assembly when fitted from floor to ceiling of 200kg. As with all cable installations it is the clients' responsibility to assess the suitability of the substrate being fixed to. Instructions for installation as well as technical advice are available from any of the Shopkit showrooms or website.

The full range of Shopkit's merchandising equipment including glass cabinets can be supported on the 3.0mm stainless steel Maxi system. Due to the wide range of components and the strength of the system the Maxi system offers the greatest creative freedom of any cable system. From staircase balustrading, tensioned canopies and external banners to suspended displays, the Maxi cable is the solution.

All components are supplied as standard in satin anodised aluminium but are also available in bright polished or brushed stainless steel.



3.5
3mm stainless steel cable



3.3
End stop



T3.2
End stop + top fixing for track

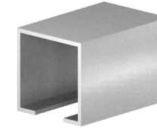

T15.1
track

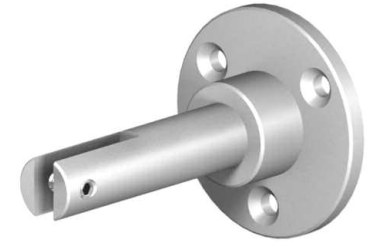

3.9
Fixing plate with extended arm



3.1
Fixing plate



3.4
Tensioner



T3.3
Tensioner + bottom fixing for track



3.24
Inline tensioner

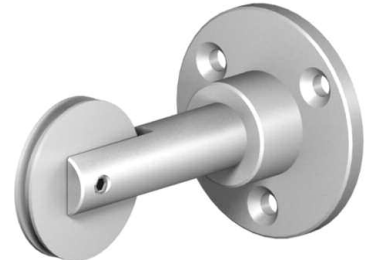

3.7
Pulley wheel fixing plate



3.2
Twin fixing plate

Maxi Cable 3mm



3.17
Single sided 10mm
glass shelf support



3.25
Double sided 10mm
glass shelf support



3.18
Single sided timber
panel or shelf support



3.28
Wall fixed 10mm
shelf/panel grip



3.27
10mm Swivel grip
for shelves



3.10
General purpose
support



3.11
Shelf support



3.12
Single sided 10mm
picture/panel grip



3.13
Double sided 10mm
picture/panel grip



3.27
10mm Swivel grip
for panels



3.19
10mm top edge grip



3.22
Picture hook



3.23
Glass or solid
panel support



3.21
End fixing

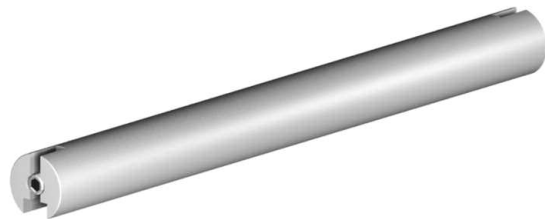

3.20
Continuous channel, various lengths

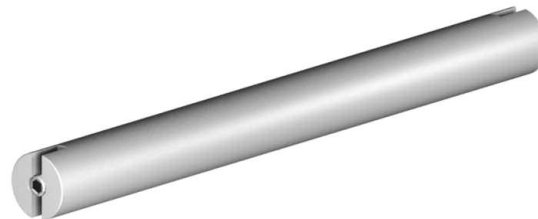

3.15
Spacer bar, 200mm cable centres



3.8
Spacer rod, 200 cable centres

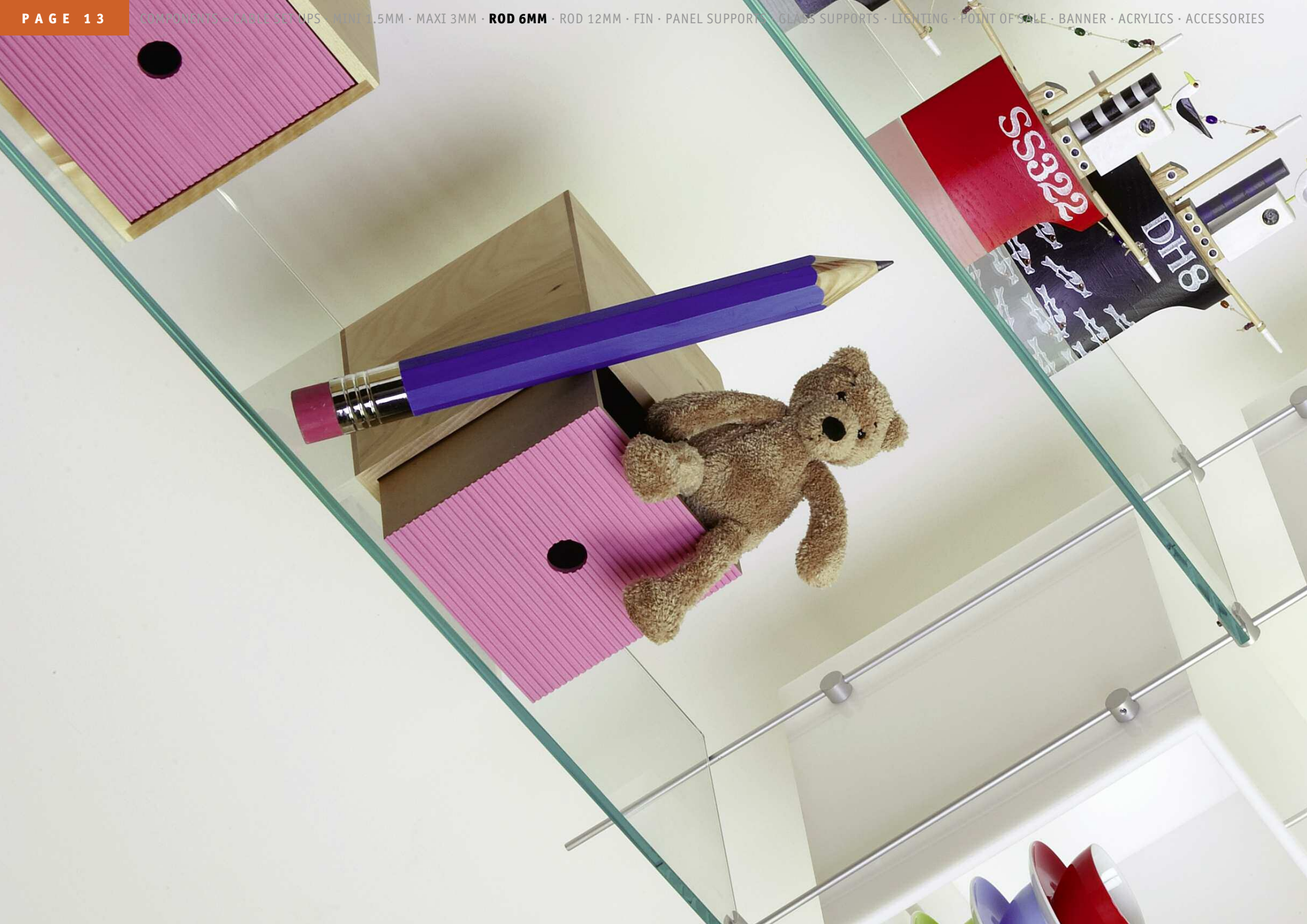

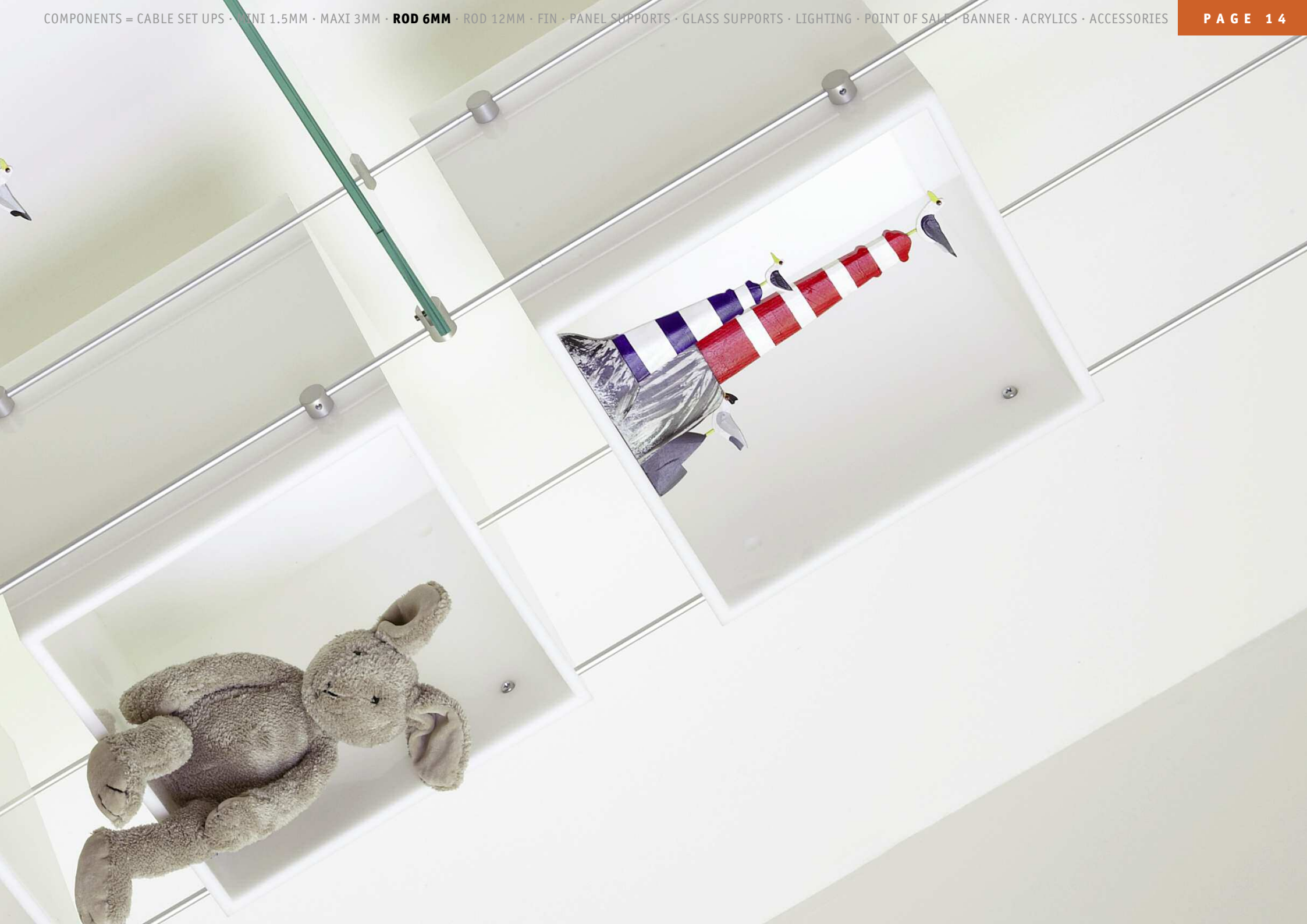

Rod 6mm

The rod system can be fixed floor to ceiling, wall to wall and from track to track. The range of components allow the rod to be fixed vertically, horizontally or in a grid with crossover connectors. This is a highly flexible and adaptable system for display shelves and graphic panels, and while strong, this system is not suitable for hanging rails for clothing in a retail environment.

Rods are available in 1m lengths, simply screw one into another to make up required lengths, with the excess being cut off at the base.

The rod range of components are available in satin anodised aluminium as standard but are also available in black anodised aluminium, brass, chromed brass and stainless steel.

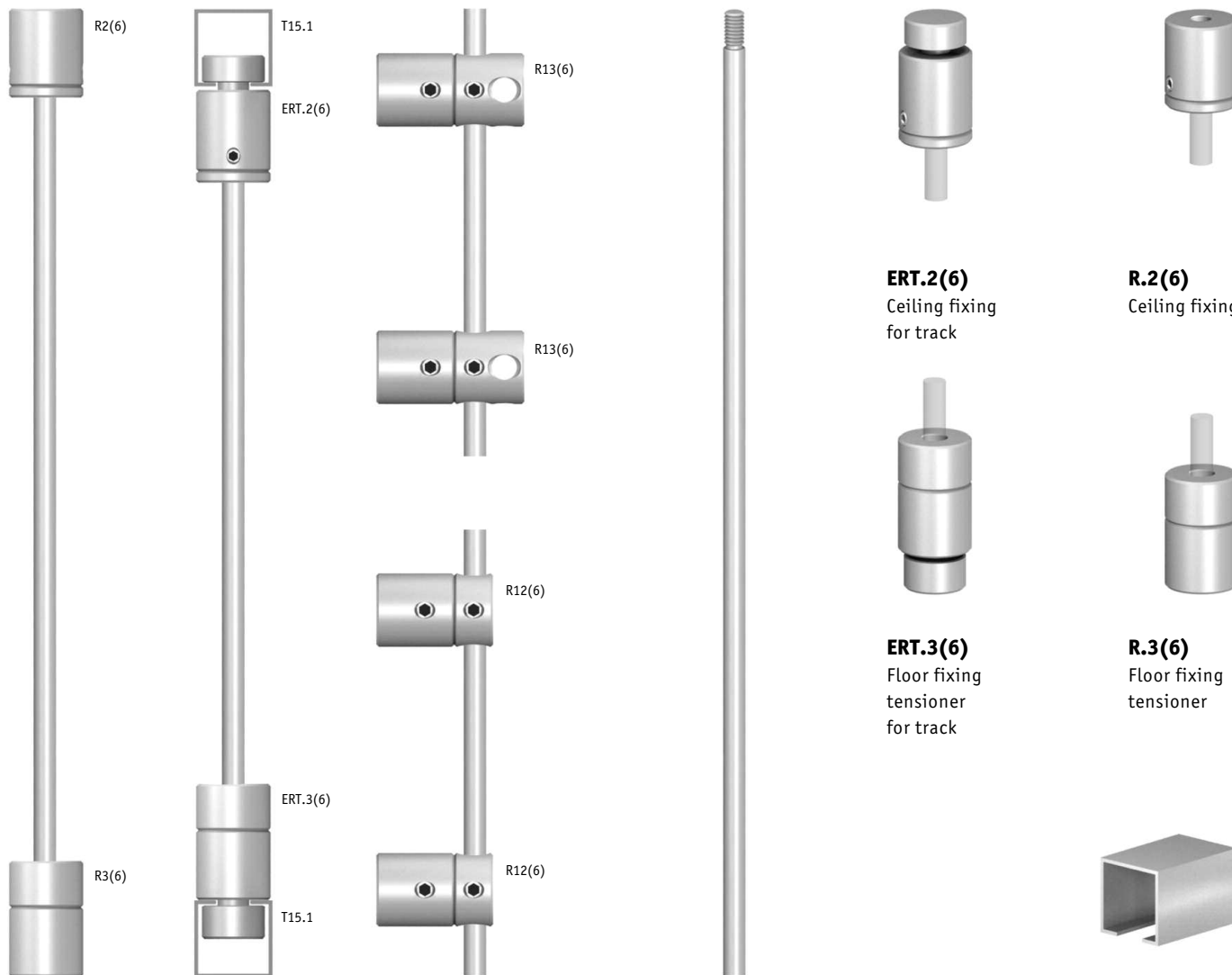

R.1(6) 6mm rod, 500mm long
R.1(6) 6mm rod, 1000mm long

T15.1
 Track

Rod 6mm



ER.4(6)
10mm glass shelf support



R.4(6)
10mm glass shelf support
(2 piece component)



ER.5(6)
Double sided 10mm glass shelf support



R.5(6)
Double sided 10mm glass shelf support
(2 piece component)



ER.6(6)
10mm panel grip



R.6(6)
10mm panel grip
(2 piece component)



R.7(6)
Double sided 10mm panel grip



R.8(6)
Cross Fixing



R.9(6)
Shelf support
(2 piece component)



R.10(6)
Double sided
Shelf support
(2 piece component)



R11(6)
Picture Hook
(2 piece component)



R.12(6)
Wall mounting



R.13(6)
Double rod wall mounting



R.14(6)
Wall end fixing



R.15(6)
Panel Support

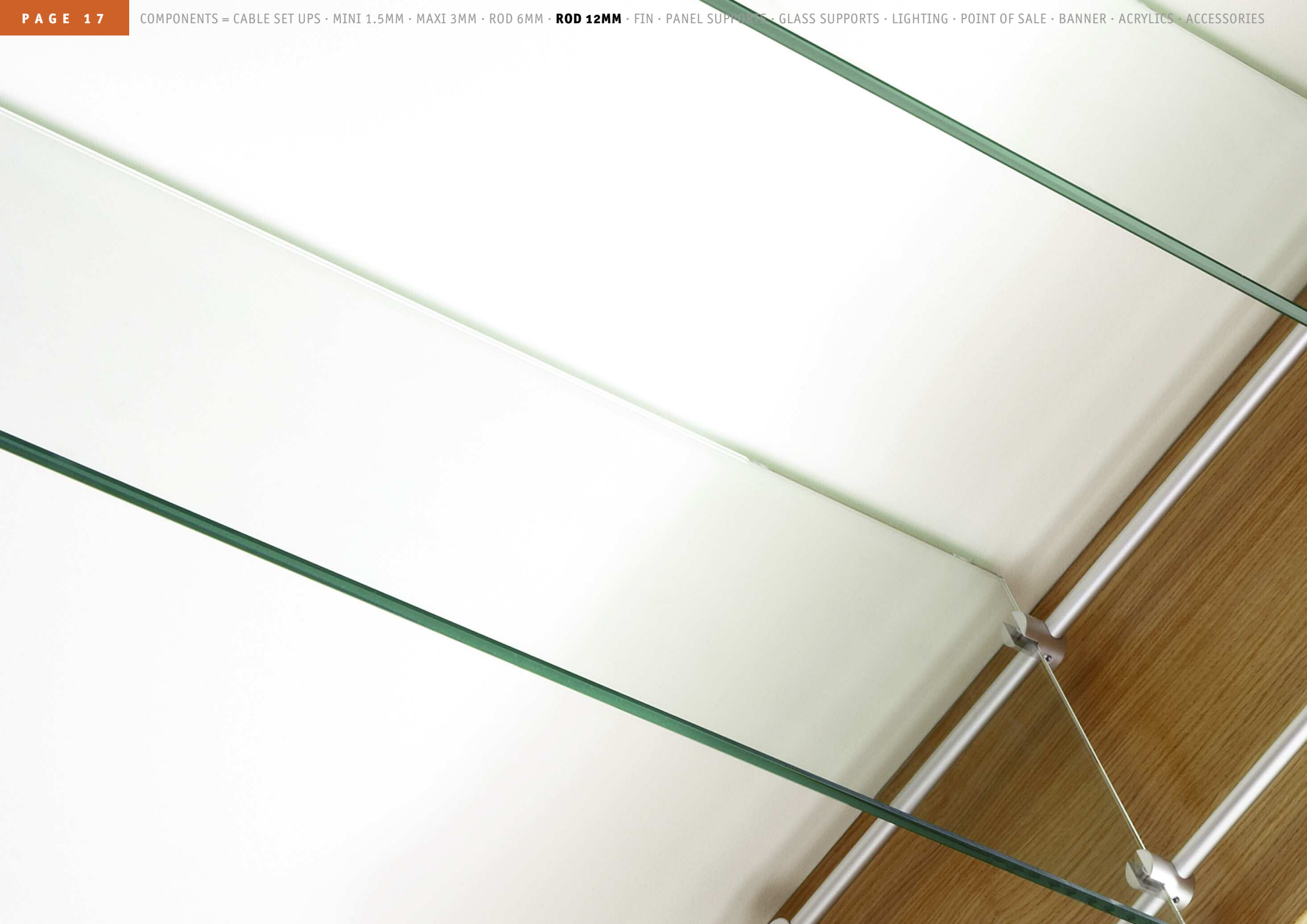

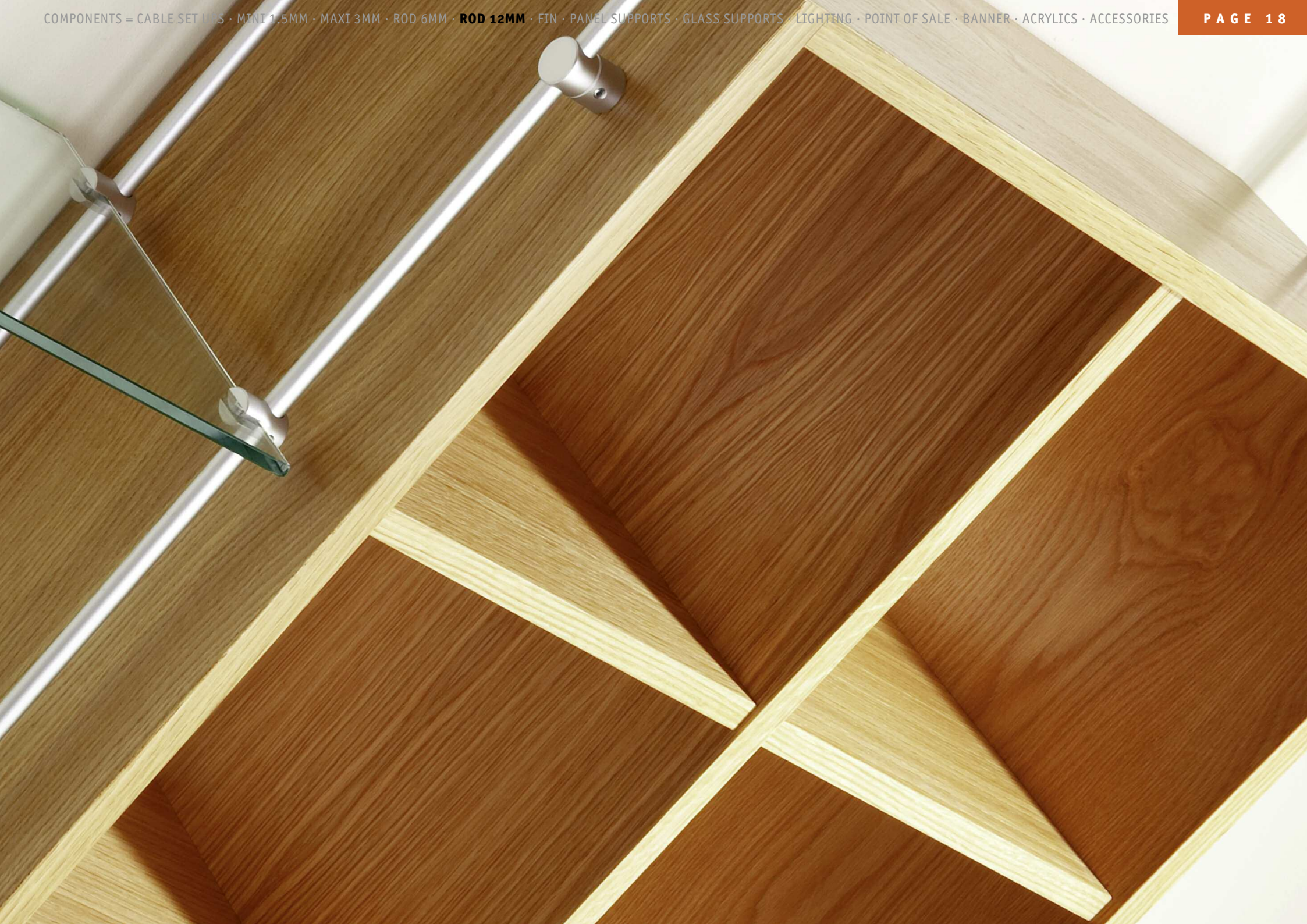

Rod 12mm

The rod system can be fixed floor to ceiling and wall to wall. The range of components allow the rod to be fixed vertically, horizontally or in a grid with crossover connectors. As with the 6mm rod this is a highly flexible and adaptable system for display shelving and graphic panels, it is not suitable for supporting hanging rails for clothing in a retail environment.

Rods are available in 1m lengths, simply screw one into another to make up required lengths, with the excess being cut off at the base.

The rod range of components are available in satin anodised aluminium as standard and are also available in black anodised aluminium and stainless steel.

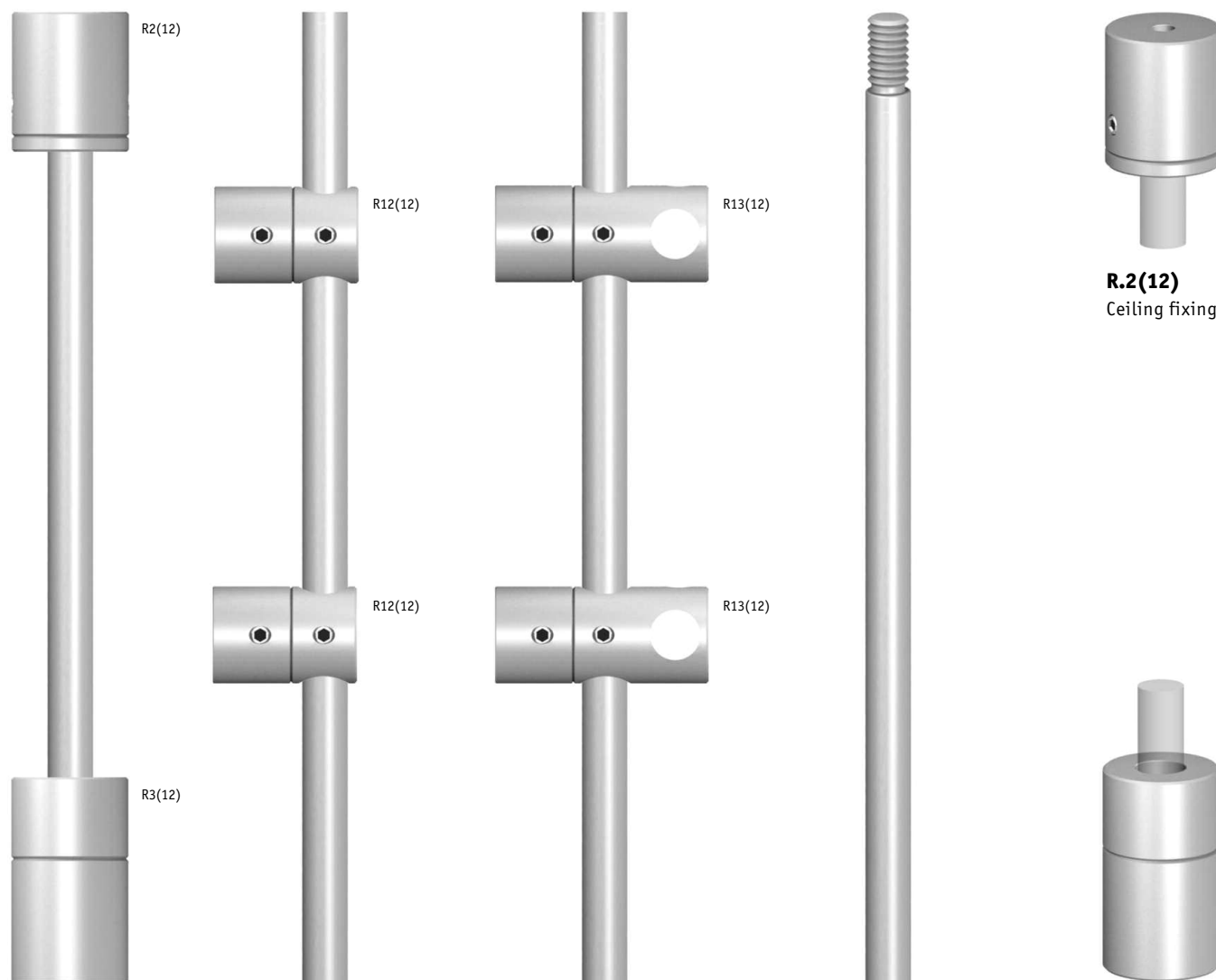

R.1(12) 12mm rod, 500mm long
R.1(12) 12mm rod, 1000mm long

R.3(12)
 Floor fixing
 tensiometer

Rod 12mm



R.6(12)
10mm panel grip



R.7(12)
Double sided 10mm panel grip



R.4(12)
10mm glass shelf support



R.5(12)
Double sided
10mm glass shelf support



R.9(12)
Shelf support



R.10(12)
Double sided shelf support



R.11(12)
Picture support hook



R.15(12)
Panel support

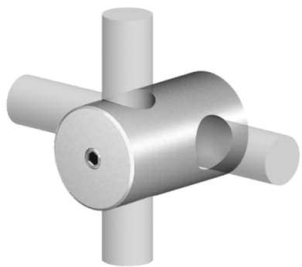

R.8(12)
Cross fixing



R.12(12)
Wall mounting

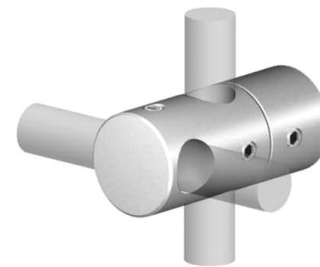

R.13(12)
Double rod wall mounting

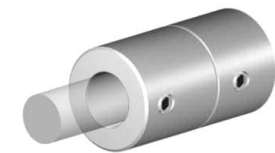

R.14(12)
Wall end fixing

Fin Mini and Maxi

(Pat No 227494)

Fin is a pre-tensioned wall fixed cable shelving system available using the Mini 1.5mm cable system or the 3.0mm Maxi cable system. The wall fixed fins are 25mm x 6mm with the Mini system, or 32mm x 6mm with the Maxi system. Both are available with fins either 1630mm or 2000mm long. If using standard accessories the distance between cables is 1175mm, however any distance up to 1200mm between cables is possible.

The advantage of a pre-tensioned cable system is that it removes the tensioned loading so only the weight of the system and what it carries is borne by the wall. This is a beautifully engineered product in satin anodised aluminium with stainless steel cables. While all of Shopkit's accessories can be used, the specially designed aluminium or wood slatted shelves complement a unique and patented design.



Mini style Fin

Shelving setup shown here with 1630 uprights

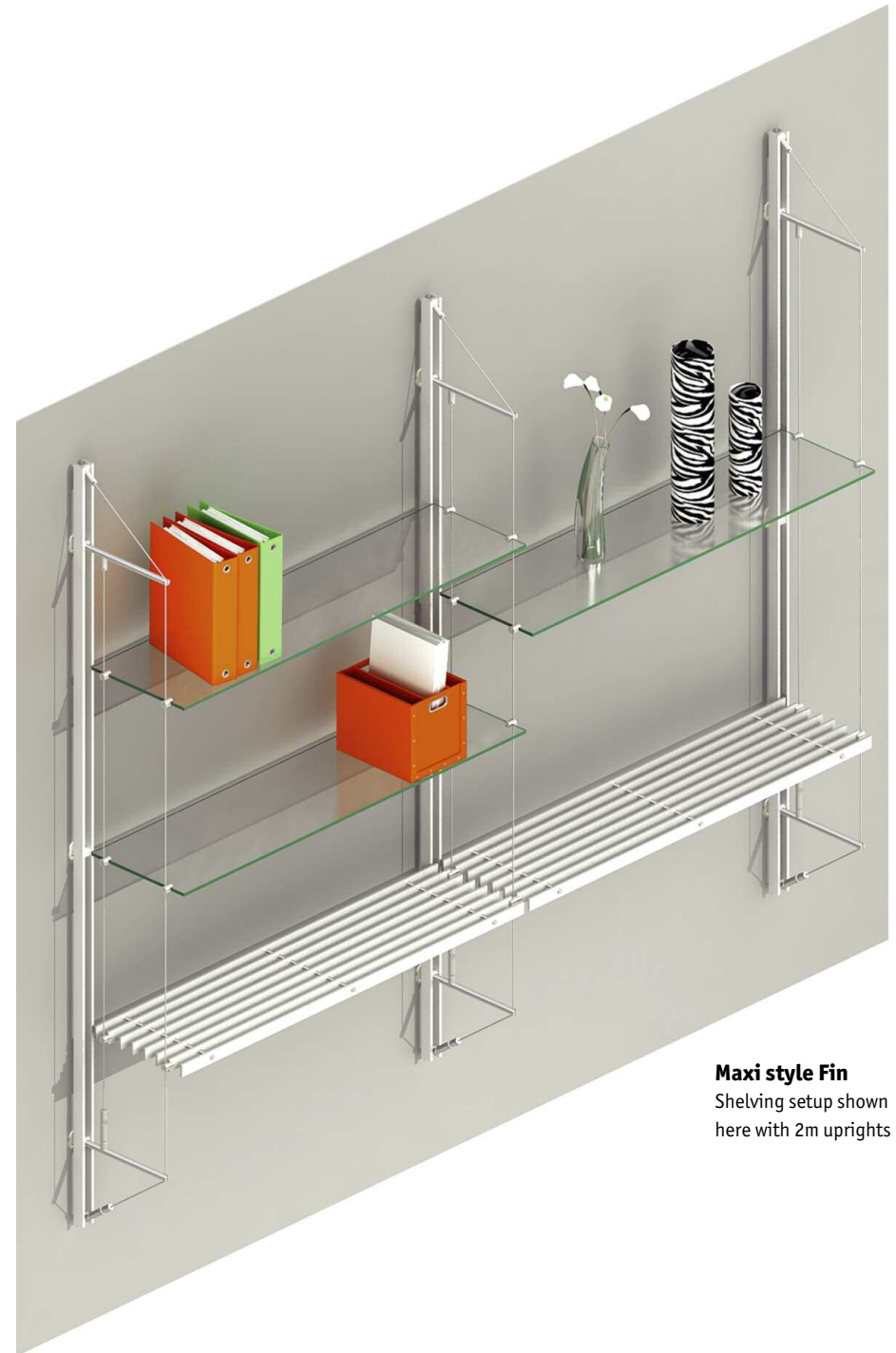

Maxi style Fin

Shelving setup shown here with 2m uprights

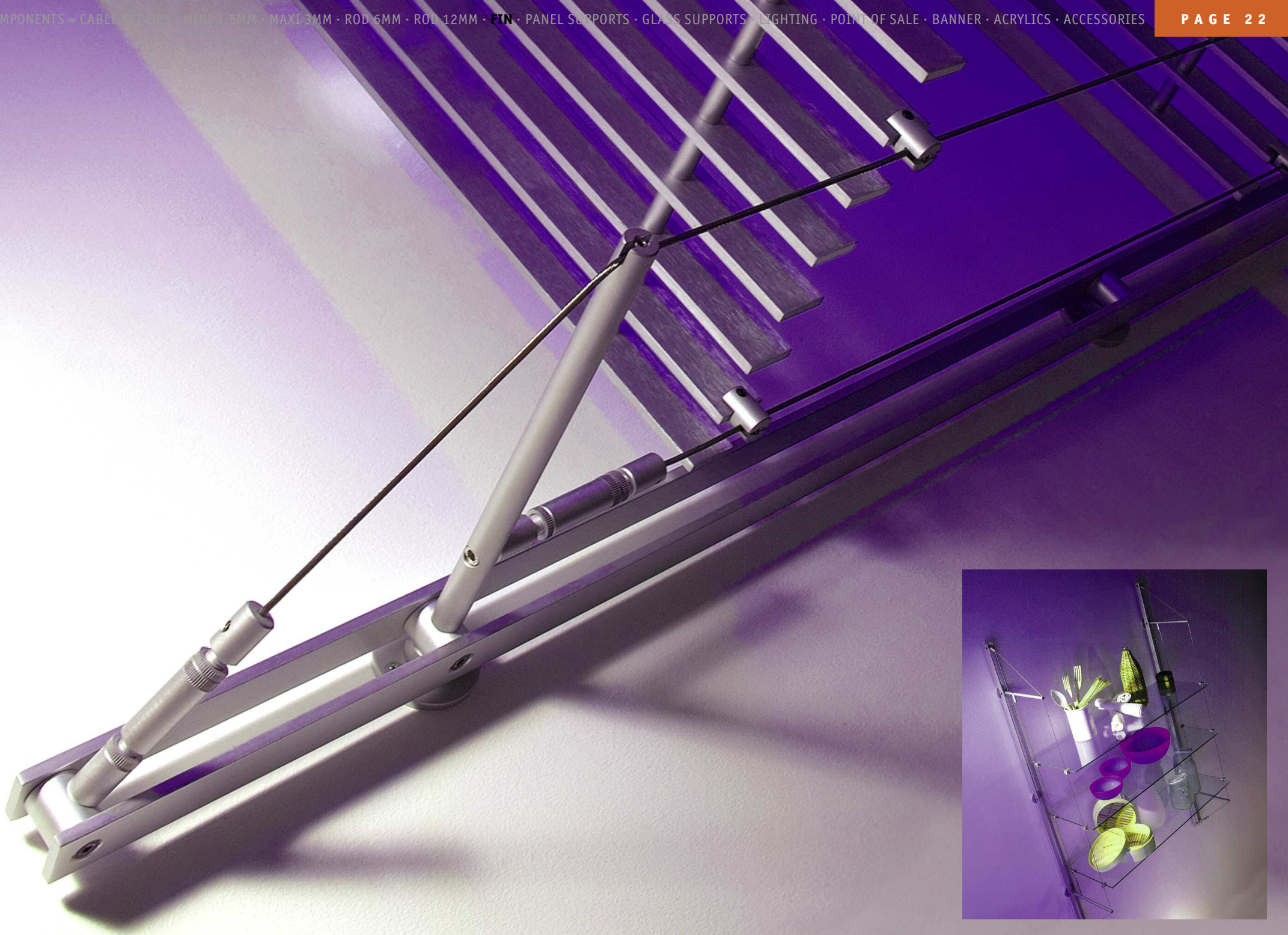



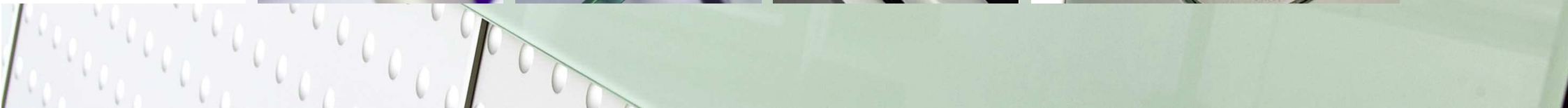

Panel Supports

For Drilled Panels

These panel supports provide an easy method to wall mount sign panels or create a raised counter top, and can be produced to hold glass or solid panels up to 25mm thick. The Micro panel support holds panels up to 10mm thick. Panels require drilling with 9mm holes. The Mini and Maxi panel supports hold panels up to 10mm thick. Panels require drilling with 13mm holes. Panels up to 25mm thick can be accommodated by specifying 'made to order' versions of components PSD.0 to PSD.5.

The standard fixing disc can be replaced by a vandal proof fixing using a countersunk allen screw. Please contact Shopkit for information and fixing details. Panel supports are available in satin anodised aluminium, brass and bright polished or brushed stainless steel.

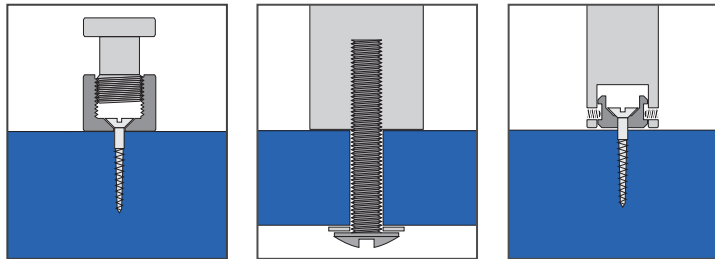

Screw fixed option

Bolt fixed option

Olive fixed option



15.35
Panel support
for drilled sheet

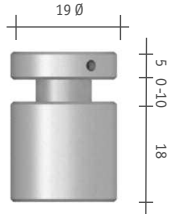

15.27
Panel support
for drilled sheet

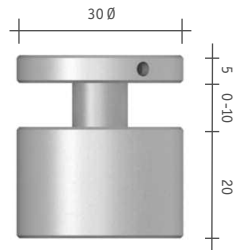

3.26
Panel support
for drilled sheet



PSD.0
Panel support
for drilled sheet



PSD.1
Panel support
for drilled sheet

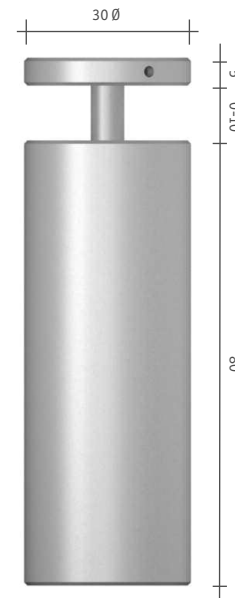

PSD.2
Panel support
for drilled sheet

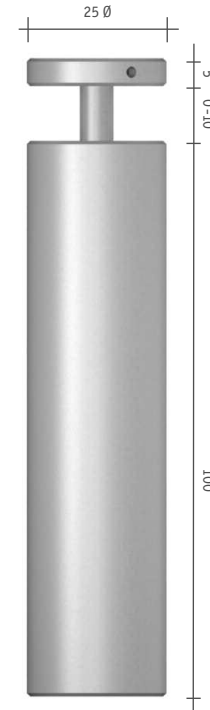

PSD.3
Panel support
for drilled sheet



PSD.4
Panel support
for drilled sheet



PSD.5
Panel support
for drilled sheet



PE.6
Edge grip
panel support



PE.5
Edge grip
panel support



PE.4
Edge grip
panel support

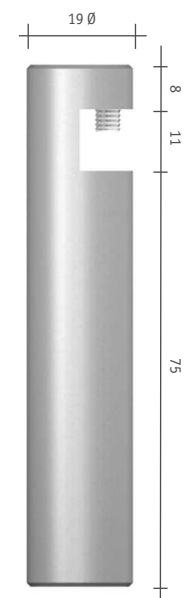

PE.3
Edge grip
panel support

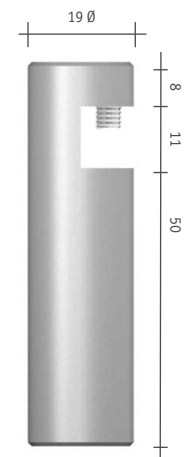

PE.2
Edge grip
panel support

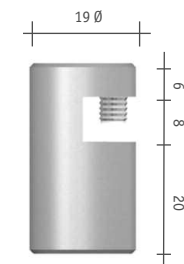

PE.1
Edge grip
panel support

Panel Supports

- Edge Fixed

The edge fixed panel supports provide an easy method to mount sign panels or create a raised counter top. They are designed for glass or solid panels ranging in thickness from 3mm to 6mm for component PE.1 and to 10mm for components PE.2 to PE.6 inclusive. Panel supports are available in satin anodised aluminium, brass and bright polished or brushed stainless steel. Fixing details are available from Shopkit.

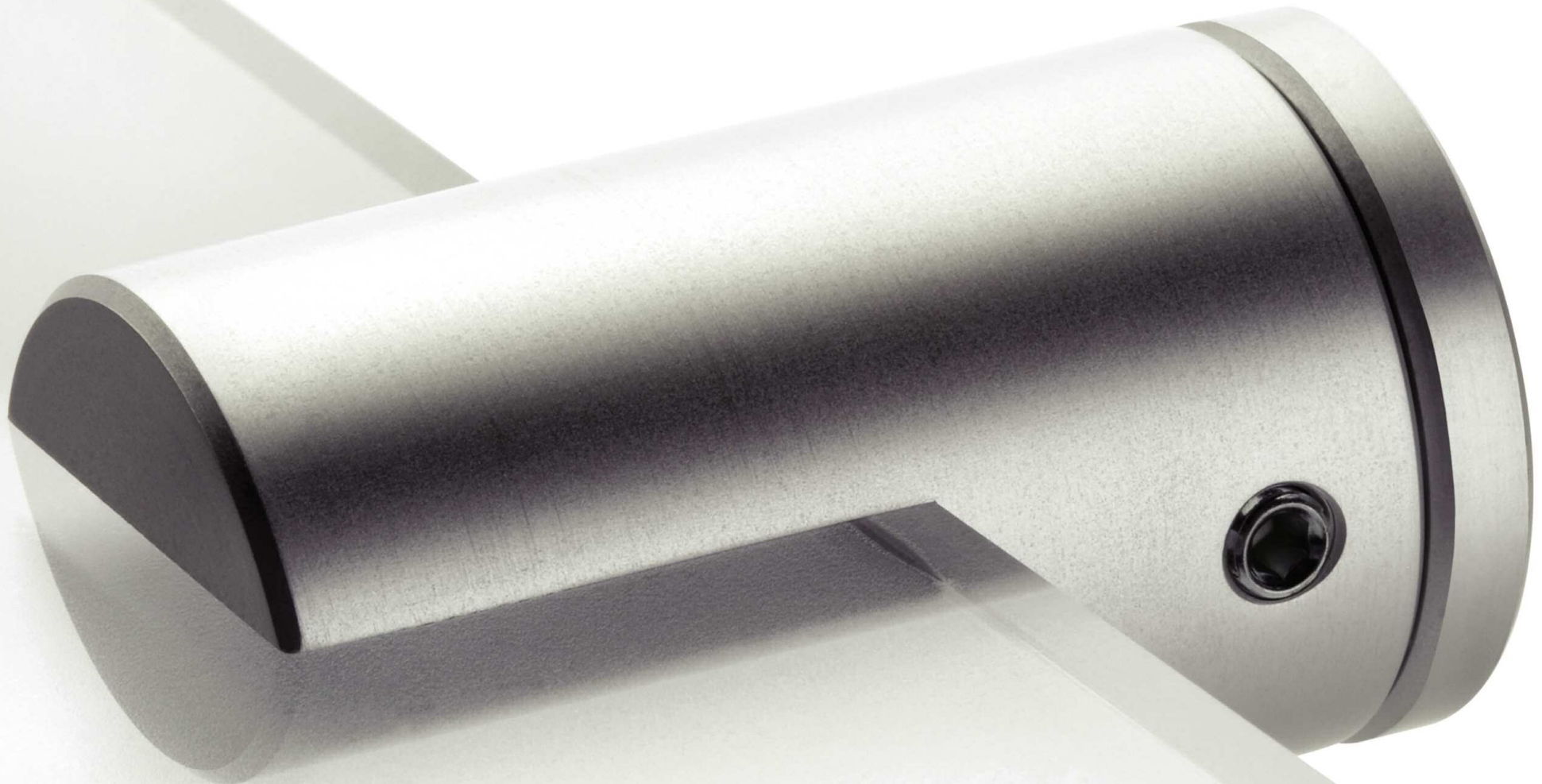



Glass Supports

Whether supporting a glass shelf panel or partition Shopkit offers two simple solutions, the first is a grip (GSC/SA) in satin anodised aluminium or (GSC/CB) in chromed brass which can be fixed to any suitable substrate whether wall, ceiling or floor. Glass up to 10mm thick can be supported. When cantilevering a shelf, wall grips should be no further apart than 1000mm and the shelf no deeper than 200mm. When supporting a sign and used vertically, it is recommended to drill a hole in the sign so the allen screw locates through the panel.

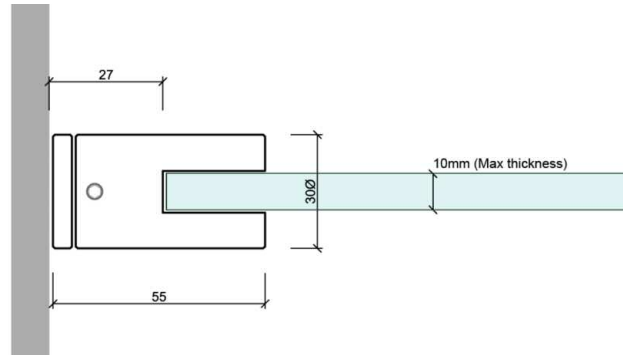

GSC/SA
Wall fixed shelf / panel clamp

The second panel or partition support is available with an adjustable leg (GPS/A) to account for uneven surfaces and a fixed leg (GPS) support, both with a 40mm diameter disc to secure the glass to the leg. These can be ordered individually or as pairs, and are produced in bright polished or brushed stainless steel.

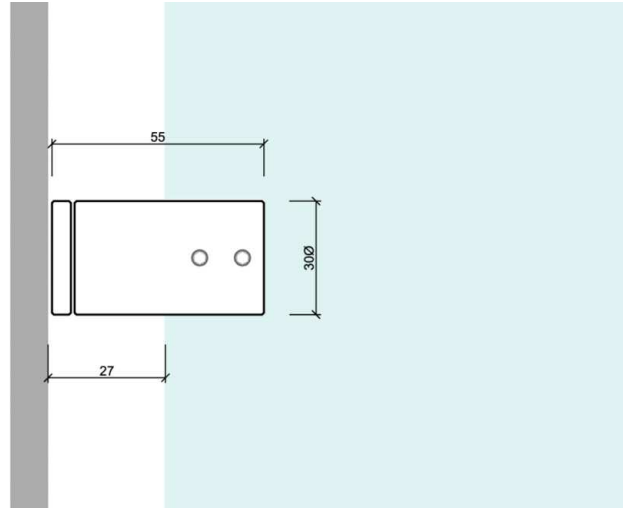

GSC/SA
Wall fixed shelf / panel clamp



GPS/A
Adjustable glass Panel Support



GPS
Glass Panel Support



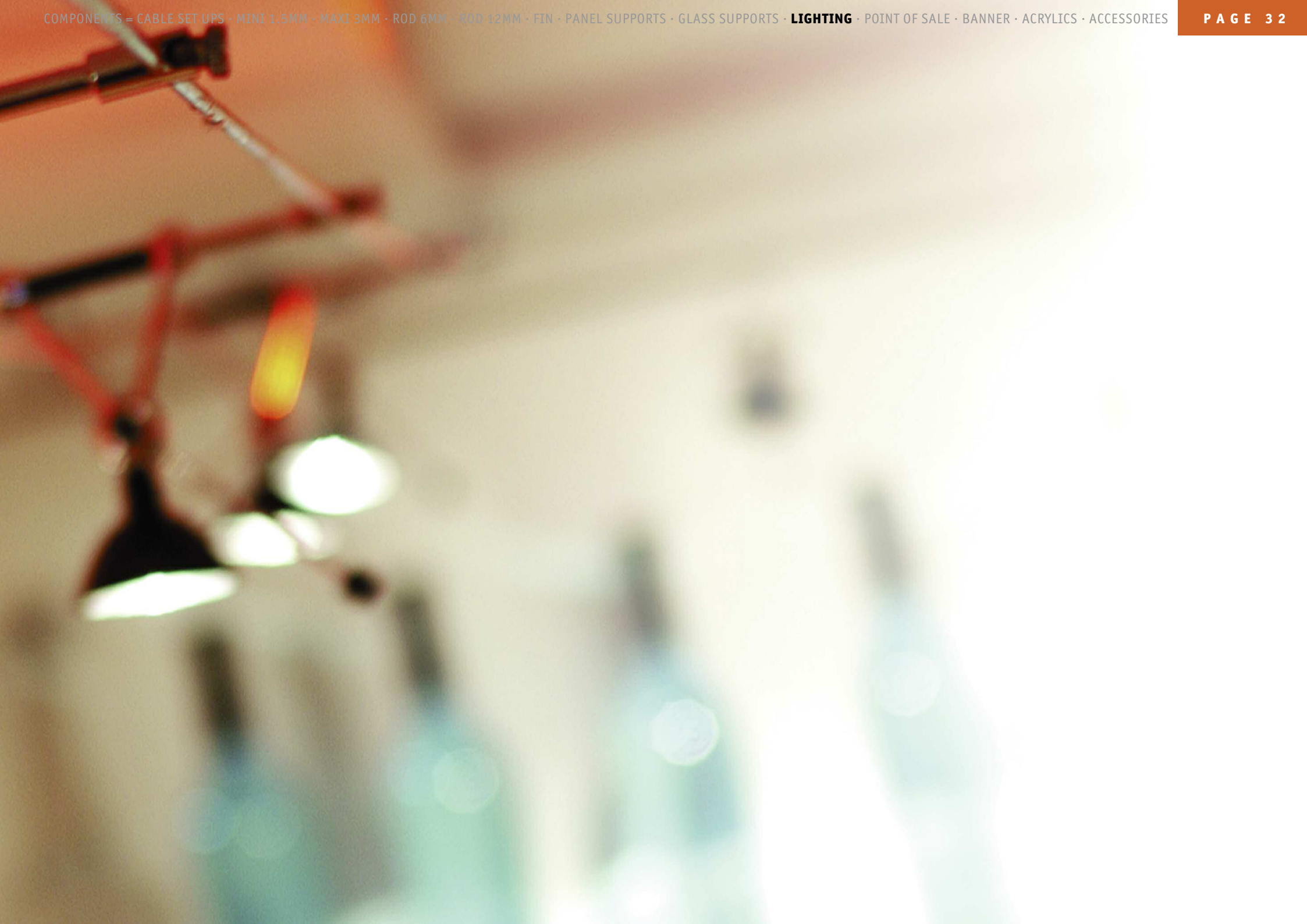

Lighting

Shopkit offers a low voltage lighting system that can be incorporated with display shelving or stand alone as required. The system comprises a special PVC coated cable combining tinned copper and stainless steel. Special nylon end stops and tensioners with a nylon barrel give isolation from the substrate they may be fixed to. Standard fixing plates are in satin anodised aluminium. The inline tensioner is also isolated and serves to break up runs of 6M giving extra tension and allowing each 6M run to have up to a maximum of 6 x 50watt bulbs when using a 300VA transformer.

TZ lamp holders are available in a variety of designs. For full details of this system and the full range of lighting components refer to the TZ lighting brochure from the Shopkit website on www.shopkit.com.

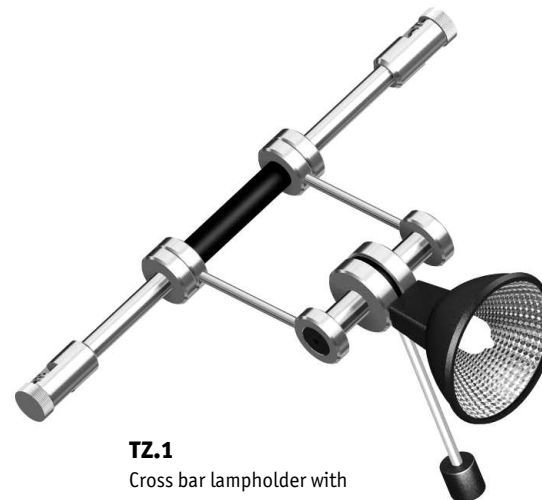

TZ.1
Cross bar lampholder with
rotating head and
150mm cable centres

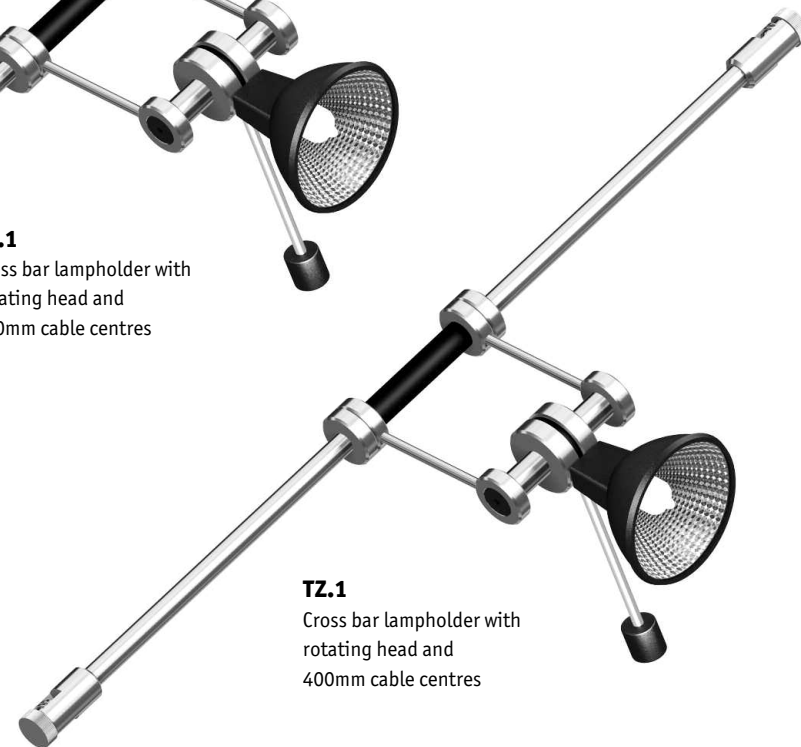

TZ.1
Cross bar lampholder with
rotating head and
400mm cable centres



L.18.20 20 watt diachroic lamp
L.18.50 50 watt diachroic lamp



L1.200
3mm PVC coated
lighting cable



L1.400
4.5mm PVC coated
lighting cable



L4
Nylon end stop



L13
Secondary power
feed cable



L14
End connector for power cable



L12.100
100VA transformer



L12.200 200VA transformer
L12.300 300VA transformer



3.1
Fixing plate



L3
Isolated tensioner



L7
Inline tensioner



Point of sale

Banners, brochures, lecterns

FSB/01/S – FSB/01/D

A tensioned single or double sided freestanding banner stand. The frame is mild steel powder coated silver with four stainless steel adjustable feet.

Banner size: 1050mm wide x 1966mm high.

FSB/02/S – FSB/02/D

A single or double sided freestanding banner stand. The frame is mild steel powder coated silver with three stainless steel adjustable feet.

Banner size: 600mm wide x 1800mm high.

FSB/03/S – FSB/03/D

A tensioned single or double sided freestanding tensioned cable banner stand. The frame is mild steel powder coated silver with three stainless steel adjustable feet.

Banner size: 500mm wide x 1400mm high.

BRS/01

Brochure display stand can accommodate up to 8 x A4 acrylic brochure holders. The mild steel frame is powder coated silver with four stainless steel adjustable feet.





FSB/01/S – Single sided banner
FSB/01/D – Double sided banner



FSB/02/S – Single sided banner
FSB/02/D – Double sided banner



FSB/03/S – Single sided banner
FSB/03/D – Double sided banner

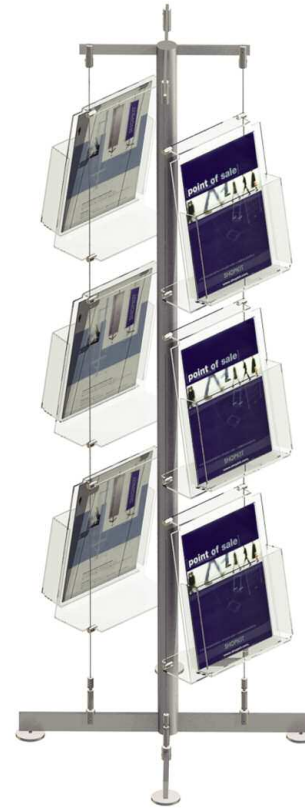

BRS/01
 Brochure holder stand



LECT/01 A4. Port
LECT/01 A3. Land
 A4 or A3 Lectern stand



POS/01
 Card holder

LECT/01 A4. Port & LECT/01 A3. Land

Manufactured from satin anodised aluminium the lectern stand is available in A4 portrait or A3 landscape format. A clear acrylic sheet sandwiches a printed graphic sheet against a satin aluminium back plate.

POS/01

A stainless steel point of sale stand in a brushed finish allows cards of different sizes to be gripped in an angled horizontal slot.

Banners

Using the principle of tensioned cables Shopkit offer a range of stainless steel components. Illustrated are five typical installations, A, B, C, D and E. Options A, B and C are wall fixed projecting banners, and options D and E are wall fixed and flat to the wall.

Banners can be manufactured to virtually any size and Shopkit will advise on individual requirements. It should be noted that banner types C and E can only be fitted to interior locations, while types A, B, and D can be used internally or externally.

It is important to assess the suitability and condition of any wall before fixing any of the banner systems. It is advisable to consult a Structural Engineer in most instances when fixing to old buildings or in exposed and windy conditions.

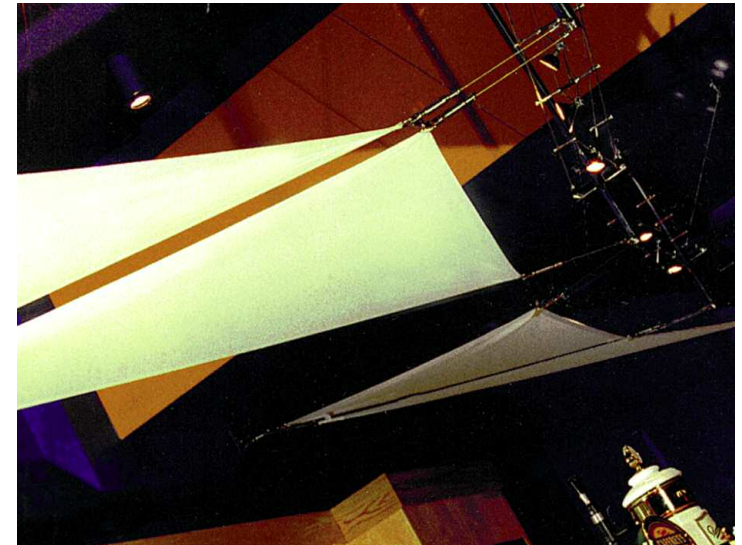



Type A
Exterior or interior



Type B
Exterior or interior

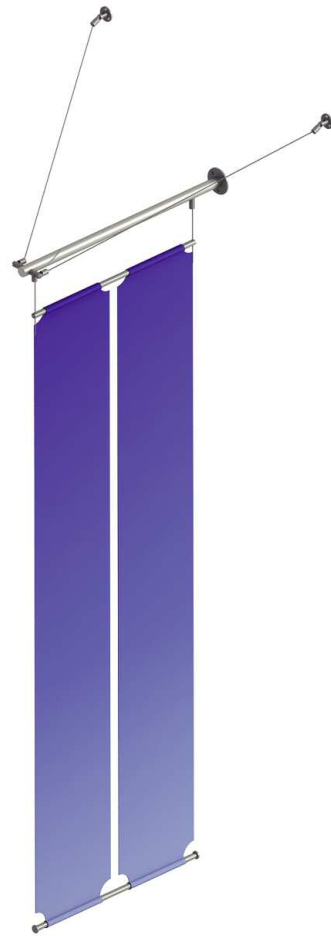

Type C
Interior



Type D
Exterior or interior



Type E
Interior

Acrylics

Illustrated are the basic range of acrylic holders, frames and pockets which are available from A1 to A4. All acrylic products are manufactured by Shopkit who offer a design and production service to meet individual requirements. All acrylic products are available in a wide range of colours and finishes. Please contact Shopkit for further details.

1) Wall fixed acrylic holder with removable front panel, available in various sizes.

2) Desk standing acrylic holder, with removable front panel, available in various sizes.

3 and 4) Cable or rod fixed easy access acrylic holder in portrait or landscape format available from A4 to A0.

5 and 6) Wall fixed easy access acrylic holder in portrait or landscape format, available from A4 to A1.

7 and 8) cable or rod fixed acrylic brochure holders, vertical or angled, various sizes available on request.



1



2



3

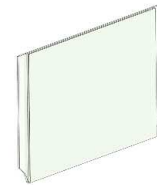

4



5



6



7



8

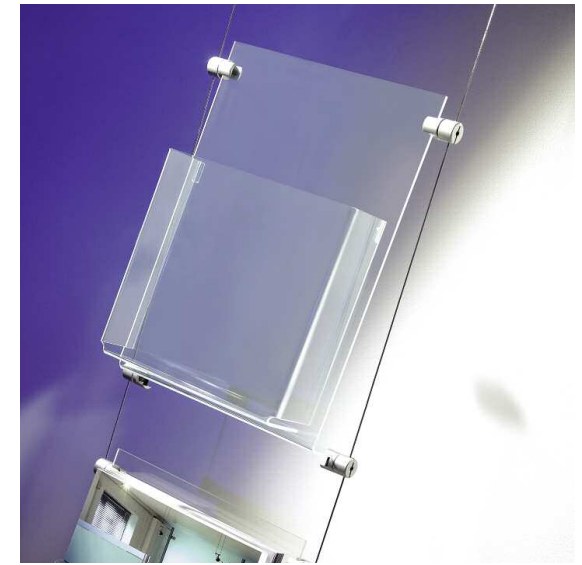

Accessories

Glass Cabinets

Cabinets 600mm h x 1150mm w x 300mm deep.
Lighting optional.
Cabinet 1200mm h x 1150mm w x 300mm deep.
Lighting optional.

Hanging Rails

Polished stainless steel hanging rail.
Polished stainless steel twin front appraisal arms
Polished stainless steel twin stepped front
Appraisal arms.
All supplied with cable grips.

Shelving

Standard shelving 300mm x 1150mm
8mm toughened glass with 50mm s/steel lip.
8mm toughened glass.
40mm timber. Choice of veneers.
40mm timber. Choice of spray colours.
30mm satin anodised aluminium slats.
All shelves supplied with cable grips.

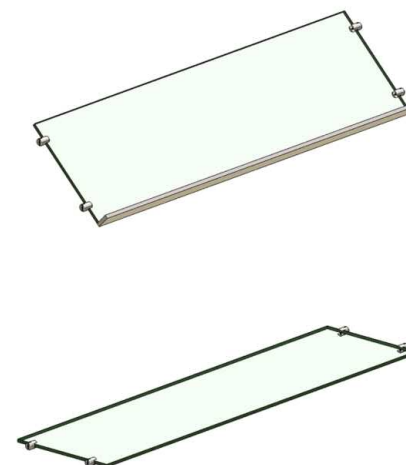

Hanging Rails

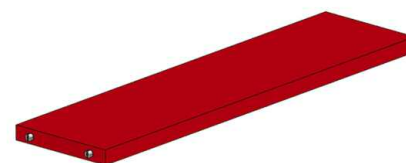
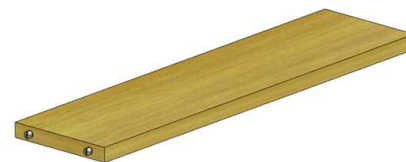

Cabinets



Shelving

Bespoke
Contact Shopkit technical support for
individual design solutions and product details.

COMPO

ONENENTS

COMPONENTS

THE DEFINITIVE RANGE
CABLE + ROD ACCESSORIES
PANEL SHELF FIXINGS

SHOPKIT GROUP LIMITED

100 Cecil Street · North Watford · Hertfordshire WD24 5AD · England

Tel: +44 (0)1923 818282 Fax: +44 (0)1923 818280 email: sales@shopkit.com web: www.shopkit.com

SHOPKIT EXPORT LIMITED

100 Cecil Street · North Watford · Hertfordshire WD24 5AD · England

Tel: +44 (0)1923 818282 Fax: +44 (0)1923 818280 email: sales@shopkit.com web: www.shopkit.com

SHOPKIT EXPORT LIMITED - GERMANY

Ader Str. 64 · 40215 Düsseldorf · Germany

Fon: +49(0)211/38 69 6-0 Fax: +49(0)211/38 69 6-24 email: info@shopkit.de web: www.shopkit.de