

06

## GRP Canopies & Architectural Mouldings





**Wetherby Building Systems Ltd manufacture and supply a wide range of GRP door canopies and architectural feature mouldings.**

**What is GRP?**

An abbreviation for 'glassfibre reinforced plastic', GRP is also referred to as 'fibreglass'.

An amazingly versatile material, GRP has great potential across a wide variety of applications and has successfully been used for decades as a strong, lightweight construction material on ocean going yachts, racing cars, swimming pools etc. In essence, GRP is a 'plastic', but it displays very few of the less favourable properties of the conventional 'thermoplastics' that we use everyday.

**What are the benefits of GRP?**

- **Superb Strength**  
GRP is very strong and has almost seven times the flexural strength of steel.
- **Amazing Flexibility**  
As the finished effect of a GRP structure is achieved by pouring molten material into a specially formulated mould, the final finish can be made to emulate a number of naturally occurring textures, such as timber, tile or stone.
- **Extremely Lightweight**  
The material is extremely lightweight which makes installation of the canopies much simpler than its traditional timber counterparts.
- **Easy to Maintain**  
GRP is very easy to clean and maintain. Simply wash down with soap and warm water to help maintain a bright, fresh look – best of all, no more painting!
- **Water, Heat & U-V Resistant**  
Offers high levels of water resistance and will not buckle or distort in high temperatures.

Should you require further details on our standard range of canopies, up to date prices, or if you would like to discuss a bespoke project, please call

**WBS TECHNICAL SUPPORT on 08458 382380.**

Alternatively, further information can be found on our website [www.wbs-ltd.co.uk](http://www.wbs-ltd.co.uk).

# WBS Canopy Range

## ASCOT



A realistic, rolled, lead-effect GRP door canopy, manufactured with a smooth or scalloped edge.

The Ascot is available in lead-grey as standard and in a number of sizes to suit site conditions.

Suitable gallows: GB5, GB6, GB7, GB8

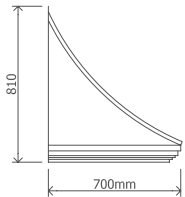

Side Elevation

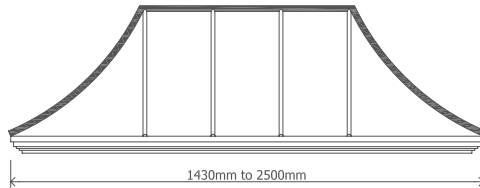

Front Elevation

**Overall Width:** 1430mm - 2500mm  
**Projection:** 700mm  
**Overall Height:** 810mm

**Standard Widths Available:**  
 1400mm / 2000mm / 2400mm

## ASCOT BAY 45

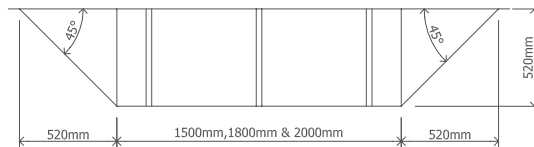

Plan

Devised especially for bay windows and based on the standard Ascot, the Ascot Bay 45 incorporates a 45° splay at both ends.

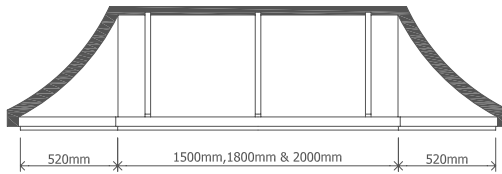
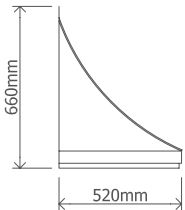

Front Elevation

**Overall Width:** 2540mm to 3040mm  
**Projection:** 520mm  
**Overall Height:** 660mm

**Standard Widths Available:**  
 1500mm (2540mm overall)  
 1800mm (2840mm overall)  
 2000mm (3040mm overall)

## ASCOT BAY 90



Another canopy perfect for bay windows, the Ascot Bay 90 is a realistic, rolled, lead-effect GRP canopy, manufactured with a smooth or scalloped edge.

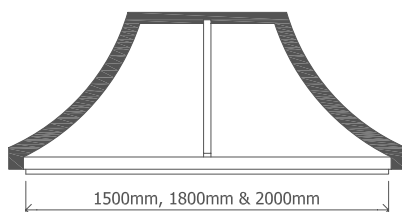
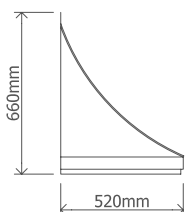

**Overall Width:** 1500mm, 1800mm & 2000mm  
**Projection:** 520mm  
**Overall Height:** 660mm

**Standard Widths Available:**  
 1500mm / 1800mm / 2000mm

# WBS Canopy Range

## WOODSTOCK



A traditional, cottage style canopy with timber grain effect sides and fascia. Fabricated entirely from GRP.

Available with a straight or decorative fascia and tile effect roof in slate-grey, red-brown or terracotta.

The application of sand to the front seam and ridge, in a complimentary or contrasting colour, gives this canopy a realistic mortar effect.

Suitable gallows: GB1, GB2

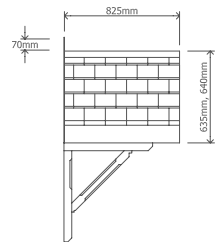

Side Elevation

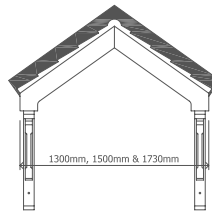

Front Elevation (Straight Fascia)

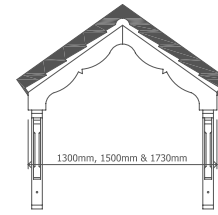

Front Elevation (Decorative Fascia)

**Overall Width:** 1300mm, 1500mm & 1730mm

**Projection:** 825mm

**Overall Height:** 1300mm = 635mm / 1500mm = 640mm / 1730mm = 740mm

## TIMBERVALE



The Timbervale is a traditional style, mono-pitch canopy, with a timber panelled effect solid fascia board (with straight or decorative fascia detailing) and a tile effect roof available in slate-grey, red-brown or terracotta.

The application of sand to the front seam and ridge, in a complimentary or contrasting colour, gives this canopy a realistic mortar effect.

Suitable gallows: GB1, GB2

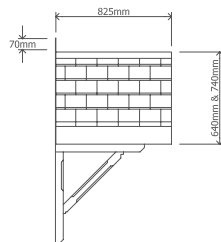

Side Elevation

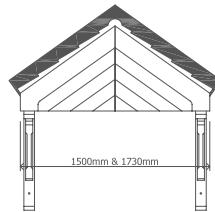

Front Elevation (Straight Fascia)

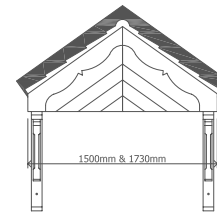

Front Elevation (Decorative Fascia)

Available with tile or slate effect roof

**Overall Width:** 1500mm & 1730mm

**Projection:** 825mm

**Overall Height:** 1500mm = 640mm / 1730mm = 740mm



# WINCANTON



Based on the Woodstock canopy, the Wincanton is a traditional, cottage style, mono pitch canopy, with a straight fascia and the added addition of a decorative tri-bar feature.

The Wincanton has a tile effect roof and is available in slate-grey, red-brown or terracotta.

The application of sand to the front seam and ridge, in a complimentary or contrasting colour, gives this canopy a realistic mortar effect.

Suitable gallows: GB1, GB2

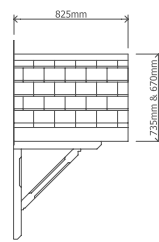

Side Elevation

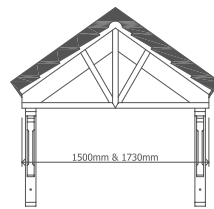

Front Elevation (Straight Fascia)

**Overall Width:** 1500mm & 1730mm

**Projection:** 825mm

**Overall Height:** 1500mm = 640mm / 1730mm = 740mm

# GOODWOOD



Based on the Timbervale canopy, the Goodwood is a traditional cottage style, mono-pitch canopy, with a straight or decorative fascia and a tile effect roof, available in slate-grey, red-brown or terracotta.

The front panel, however, is constructed using a Bluclad building board, which allows the application of pebble dash, render, brick slip or masonry paint to compliment the rest of the property.

The application of sand to the front seam and ridge, in a complimentary or contrasting colour, gives this canopy a realistic mortar effect.

Suitable gallows: GB1, GB2

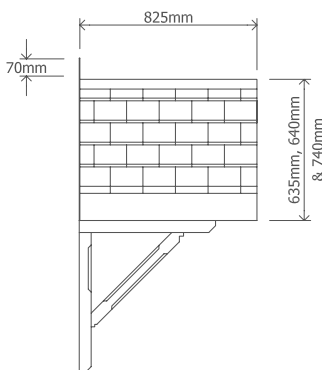

Side Elevation

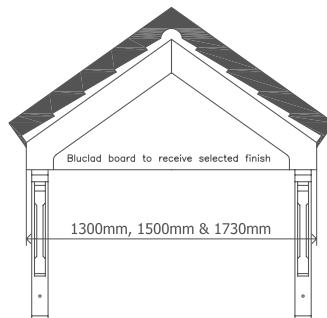

Front Elevation

**Overall Width:** 1300mm, 1500mm & 1730mm

**Projection:** 825mm

**Overall Height:** 1300mm = 635mm

1500mm = 640mm

1730mm = 740mm



# WBS Canopy Range

## HAYMARKET



A traditional, elegantly styled, single GRP door canopy. The lead-effect roof on this canopy is available with a smooth or scalloped edge in lead-grey or white.

Suitable gallows: GB5, GB7, GB8

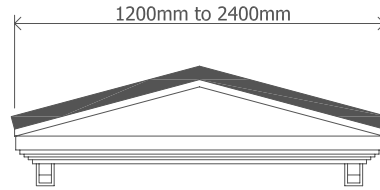

Front Elevation

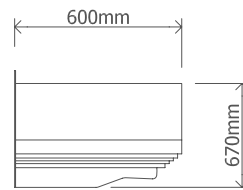
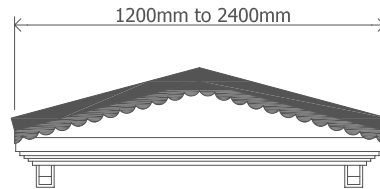

Side Elevation

**Overall Width:**  
1200mm to 2400mm

**Projection:**  
600mm

**Overall Height:**  
670mm

## WESTBERRY



A traditional style, mono-pitch canopy constructed entirely from GRP, with a tile effect roof available in slate-grey, red-brown or terracotta.

The application of sand to the side seams, in a complimentary or contrasting colour, gives this canopy a realistic mortar effect.

Suitable gallows: GB1, GB2, GB5, GB6, GB7, GB8

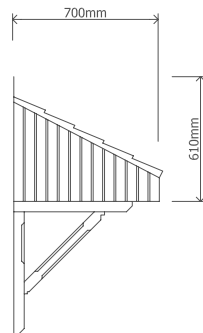

Side Elevation

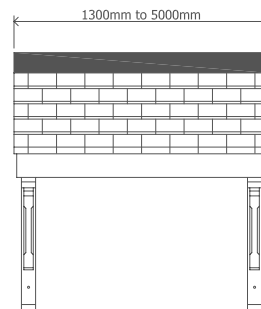

Front Elevation

**Overall Width:**  
1300mm to 5000mm

**Projection:**  
700mm

**Overall Height:**  
610mm

**Standard Widths Available:**

- 1300mm
- 1400mm
- 1500mm
- 1800mm
- 2000mm
- 2500mm
- 3000mm



# HOPBERRY



A variable width, mono-pitch canopy with timber grain effect sides and fascia. Tile or slate effect roof available in slate-grey, red-brown or terracotta. The application of sand to the side seams in a complimentary or contrasting colour, gives the canopy a realistic mortar effect.

The maximum width of this canopy is a generous 5 metres, making it ideal for use over multiple door widths.

Suitable gallows: GB3, GB4

**Overall Width:** 1220mm to 5000mm

**Projection:** 550mm & 700mm

**Overall Height:** 780mm

**Standard Widths Available:**

1300mm	2000mm
1400mm	2500mm
1500mm	3000mm
1800mm	

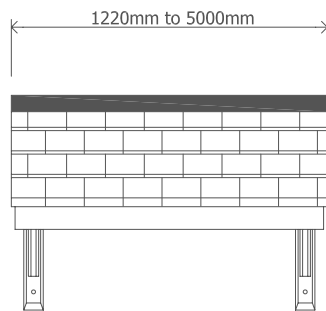
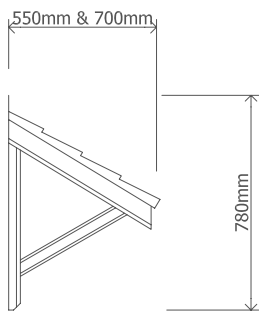

# AINTREE



A 760mm deep, flat roofed canopy, with a grey lead-effect scalloped edge and a smooth timber effect body. The Aintree is suitable for both corner applications and as a stand alone unit.

Also available with a straight or merlon (saw tooth) effect edge.

Suitable gallows: GB5, GB6, GB7, GB8

**Overall Width:** 1500 to 2400mm

**Projection:** 760mm

**Overall Height:** 150mm

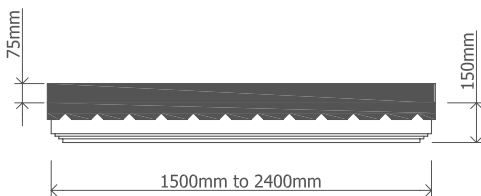

Front Elevation with V edging

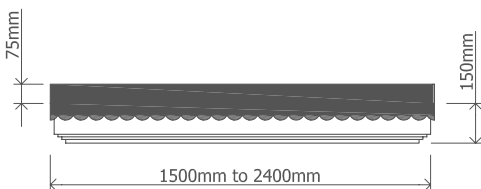

Front Elevation with scalloped edge

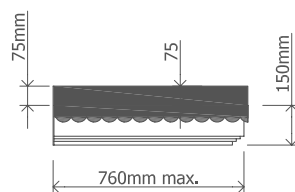

Side Elevation

# WBS Canopy Range

## LUDLOW



A classic, semi-circular, smooth bodied canopy with feature mouldings, and with a lead-effect roof available in lead-grey or white.

The Ludlow is 1500mm wide and is available in variable depths of between 300mm and 600mm.

This canopy can be mounted on gallows but is also ideal for mounting on pilasters to give a grander effect.

**Overall Width:** 1500mm

**Projection:** 300mm to 600mm

**Overall Height:** 880mm

Suitable gallows: GB7, GB8

Suitable Pilasters: PIL 1

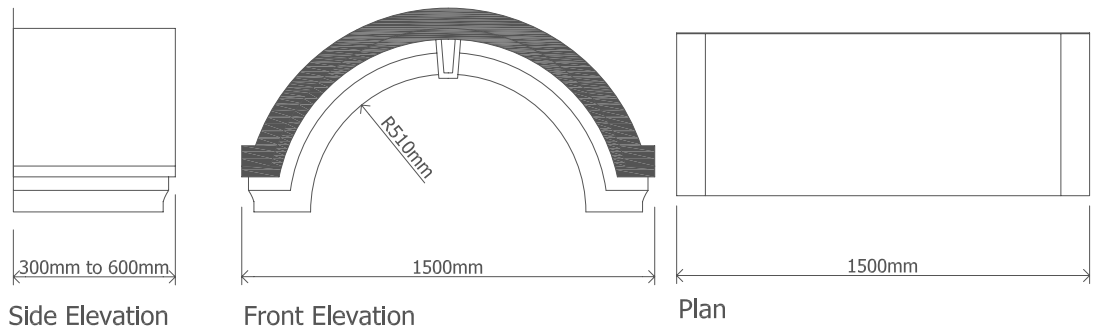

## KEMPTON



A three sided, pitched roof canopy with a ridge tile effect to front and sides, along with a textured timber effect body.

The roof of the Kempton is available in slate-grey, red-brown or terracotta.

The application of sand to the ridge of this canopy, in a complimentary or contrasting colour, gives a realistic mortar effect.

Suitable gallows: GB1, GB2

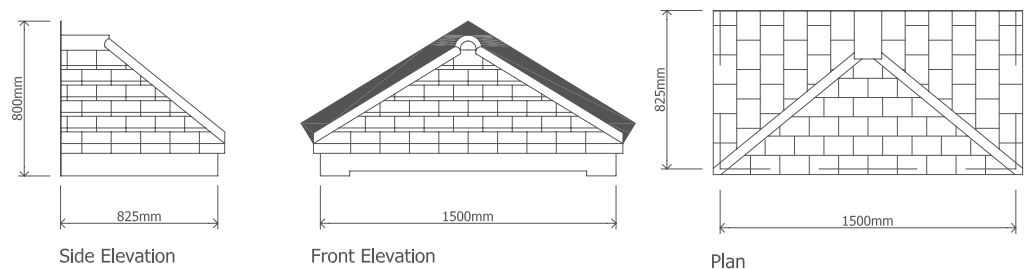

**Overall Width:** 1500mm

**Projection:** 825mm

**Overall Height:** 800mm



## THIRSK



A three sided, pitched roof canopy with a tile effect to front and sides, the Thirsk canopy is available in variable set lengths, determined by a single tile width (please call for details).

Available with a tile effect roof in slate-grey, red-brown or terracotta.

Suitable gallows: GB1, GB2, GB5, GB6, GB7, GB8

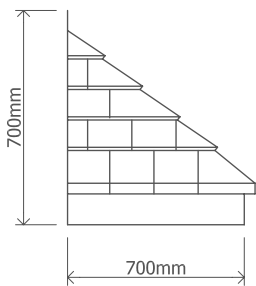

Side Elevation

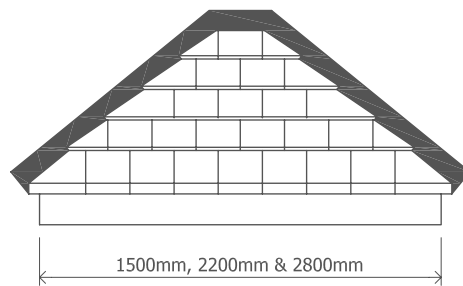

Front Elevation

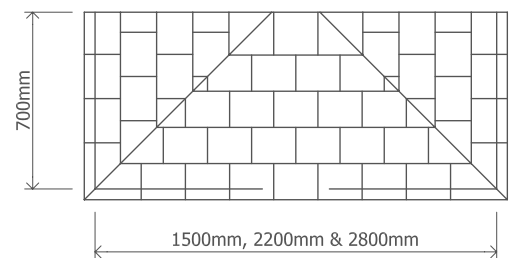

Plan

**Overall Width:** 1500mm, 2200mm, 2800mm    **Projection:** 700mm    **Overall Height:** 700mm

## NEWMARKET



A variable width, flat topped, lead-look canopy with a smooth or scalloped edge detail.

The main body of the canopy has a smooth white finish and the scalloped edging can be supplied in lead-grey or white.

This canopy may be adapted to fit over existing pre-cast concrete canopies.

Suitable gallows: GB5, GB7, GB8

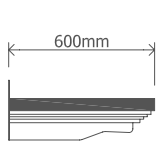

Side Elevation

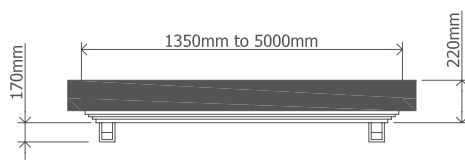

Front Elevation (Straight Fascia)

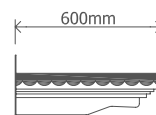

Side Elevation

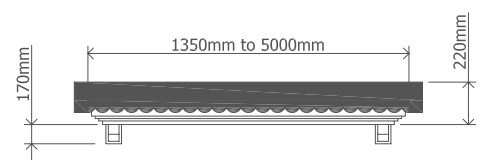

Front Elevation (Scalloped Fascia)

**Overall Width:** 1350mm to 5000mm

**Standard Widths Available:**

1500mm (2540mm overall)

1800mm (2840mm overall)

2000mm (3040mm overall)

**Projection:** 600mm

**Overall Height:** 220mm

# WBS Canopy Range

## ROOF OPTIONS



slate-grey



red-brown



terracotta



smooth-brown



lead-grey



# GALLOWS BRACKETS & PILASTERS

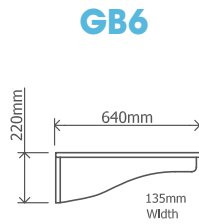
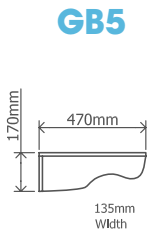
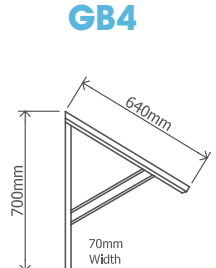
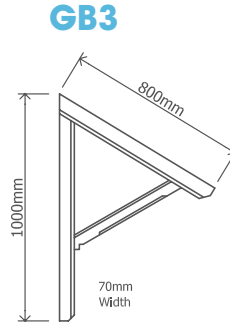
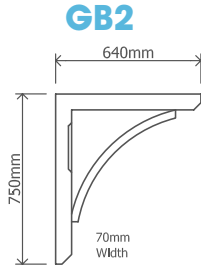
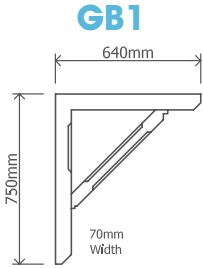

**PIL1**

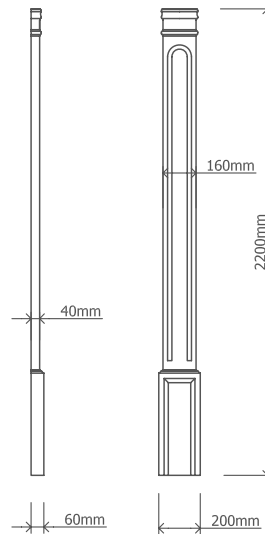

**PIL2**

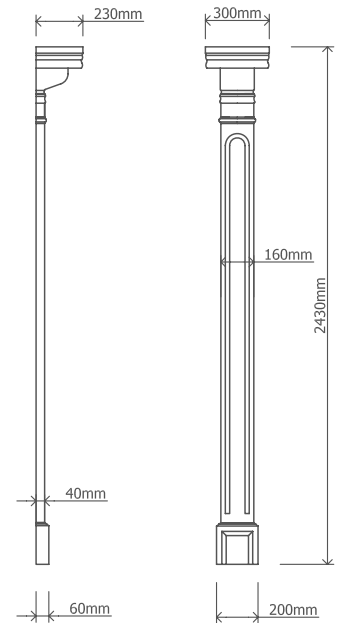

**GB7**

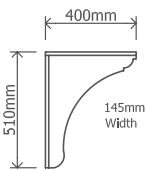

**GB8**

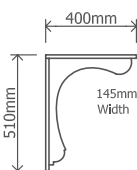

**GB9**

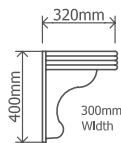

## CANOPY FIXING KITS

Fixing kits containing screws, wall plugs, washers and screw caps are available for both masonry and externally insulated installations. For further information – please contact **WBS TECHNICAL SUPPORT** on **08458 382380**.



For further details, please contact  
**WBS TECHNICAL SUPPORT** on **08458 382380**



01

**Insulated Render Systems**  
// New Build



02

**Flexible Silicone & Acrylic Finishes**



03

**WBS Brick Slip Cladding Systems**



04

**Insulated Render Systems**  
// Refurbishment



05

**Polymer Modified Renders  
& Specialist Finishes**



06

**GRP Canopies &  
Architectural Mouldings**



**head office**

1 kid glove road  
golborne enterprise park  
golborne  
greater manchester  
wa3 3gs

tel: 01942 717100  
fax: 01942 717101

**scotland**

block 14  
unit a11 coltness lane  
queenslie industrial estate  
glasgow  
g33 4dr

tel: 0141 766 1767  
fax: 0141 766 1768

**kidderminster**

unit 17a  
hartlebury trading estate  
kidderminster  
worcestershire  
dy10 4jb

tel: 01299 251666  
fax: 01299 251003

**south wales**

unit 6  
heol ty gwyn industrial estate  
maesteg  
mid glamorgan  
cf34 0bq

tel: 08450 946397  
fax: 08450 946398



[www.wbs-ltd.co.uk](http://www.wbs-ltd.co.uk)  
[info@wbs-ltd.co.uk](mailto:info@wbs-ltd.co.uk)