

**URBACO**

# Technical sheet

**Pneumatic automatic retractable bollard  
CYLINDER Model Ø250/10", Height 500/20"**

**Réf. BPCLPF50**



Impact resistance	Tested durability	Weight
9,000 joules	4.5 Million operation cycles	122 Kg/268.96 lb
Material	Thickness	Colors
Cast steel	11 mm/0.4"	Standard URBACO paint RAL colors (optional)
Fittings		Functioning
- Lower limit switch - I.P.67 air distribution set (with valve, 25m/27 years air tube and connections).		According to PLC program. The user will lower the bollard with a proximity card, remote control, digital keypad etc. The bollard will automatically or manually rise again.

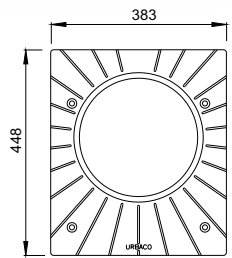

**LEGEND :**  
**1** - Casing  
**2** - cover  
**3** - bollard head  
**4** - reflecting tape

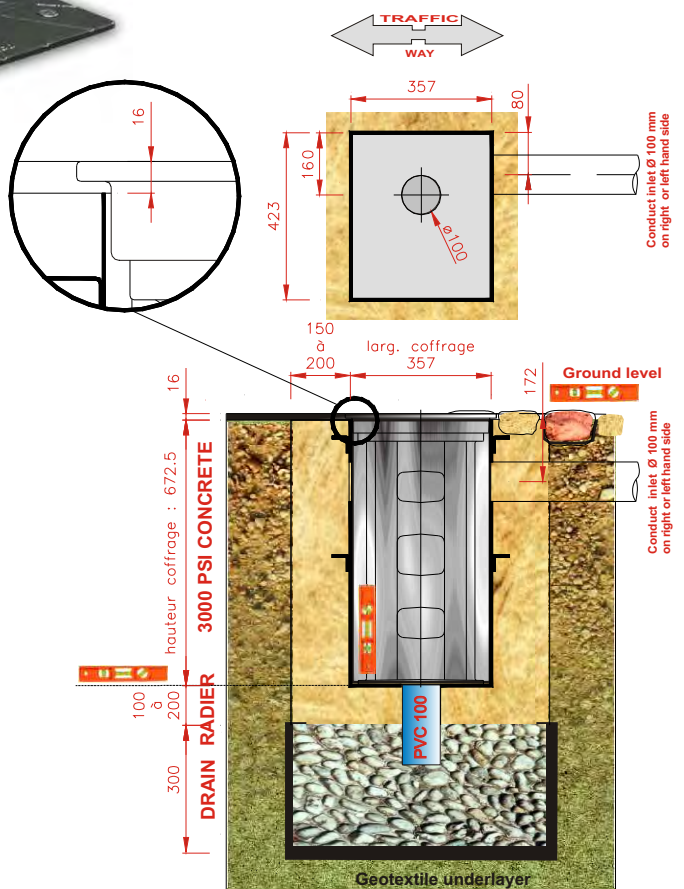
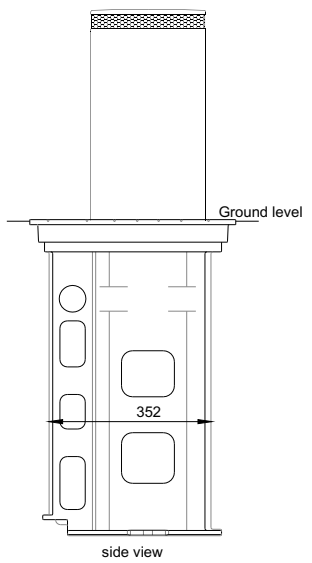
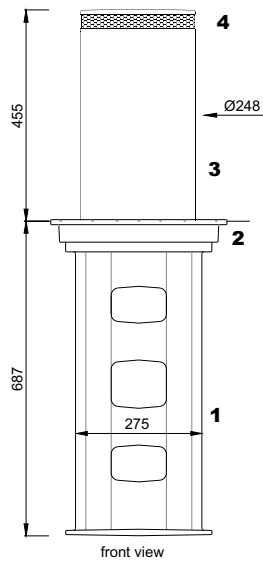

**NOTA : Natural permeable soil for drainage.**  
 (otherwise PVC tube should be connected to rainwater or sewage pipes)

**INSTALLATION PLAN**  
 for lost casing réf. BOCOFF671

**Z.A. Du Couquiou - 84320 ENTRAIGUES - FRANCE**  
 Tél. : (33) 04 90 48 08 08 - Fax : (33) 04 90 48 00 88  
 e-mail : urbaco@urbaco.fr

Propriété intellectuelle de URBACO - Ne peut être copié - Spécifications non contractuelles - Modifications possibles sans préavis



# Technical sheet

**Pneumatic Automatic retractable bollard**  
**CYLINDER Model Ø 120/5", Height 500/20"**

**Ref. BPCLPD50**



<b>Impact resistance</b>	<b>Tested durability</b>	<b>Weight</b>
2,400 joules	4 Million operation cycles	58 Kg/127.87 lb
<b>Material</b>	<b>Thickness</b>	<b>Colors</b>
Cast steel	11 mm/0.4"	Standard URBACO paint RAL colors (optional)
<b>Fittings</b>		<b>Functioning</b>
- Lower limit switch - I.P.67 air distribution set (with valve 25m/27.3 years air tube and connections).		According to PLC program The user will lower the bollard with a proximity card, remote control, radio beeper, etc. The bollard will automatically or manually rise again

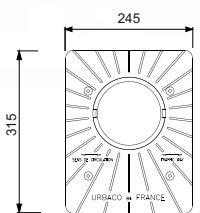

LEGEND :  
 1 - casing  
 2 - cover  
 3 - bollard head  
 4 - reflecting tape

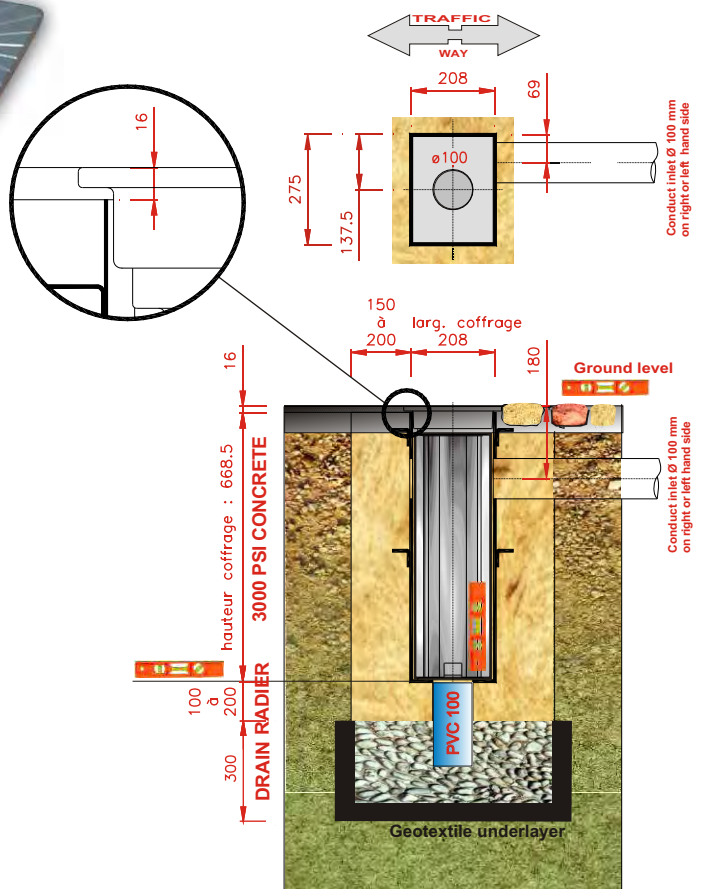
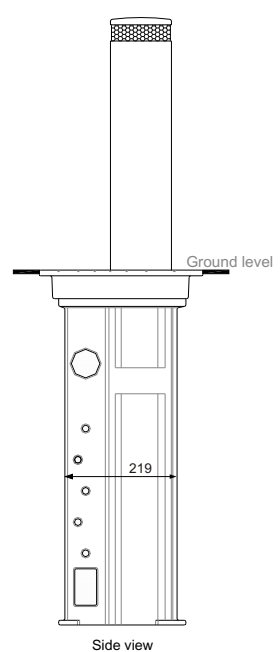
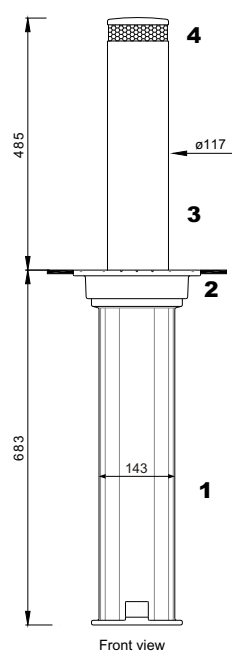

NOTA : Natural permeable soil for drainage.  
 (otherwise PVC tube should be connected to rainwater or sewage pipes)

**INSTALLATION PLAN**  
 for lost casinf ref. BOCOFD667

Z.A. Du Couquiou - 84320 ENTRAIGUES - FRANCE  
 Tél. : (33) 04 90 48 08 08 - Fax : (33) 04 90 48 00 88  
 e-mail : urbaco@urbaco.fr

Propriété intellectuelle de URBACO - Ne peut être copié - Spécifications non contractuelles - Modifications possibles sans préavis

# Technical sheet

**Pneumatic Automatic retractable bollard**  
**CYLINDER Model Ø 120/5", Height 750/30"**

Ref. BPCLPD75



Impact resistance	Tested durability	Weight
2,400 joules	4 Million operation cycles	73 Kg/160.94 lb
Material	Thickness	Colors
Cast steel	11 mm/0.4"	Standard URBACO paint RAL colors (optional)
Fittings		Functioning
- Lower limit switch - I.P.67 air distribution set (with valve 25m/27.3 yards air tube and connections).		According to PLC program The user will lower the bollard with a proximity card, remote control, radio beeper, etc. The bollard will automatically or manually rise again.

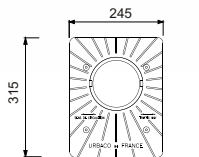

LEGEND :  
 1 - casing  
 2 - cover  
 3 - bollard head  
 4 - reflecting tape

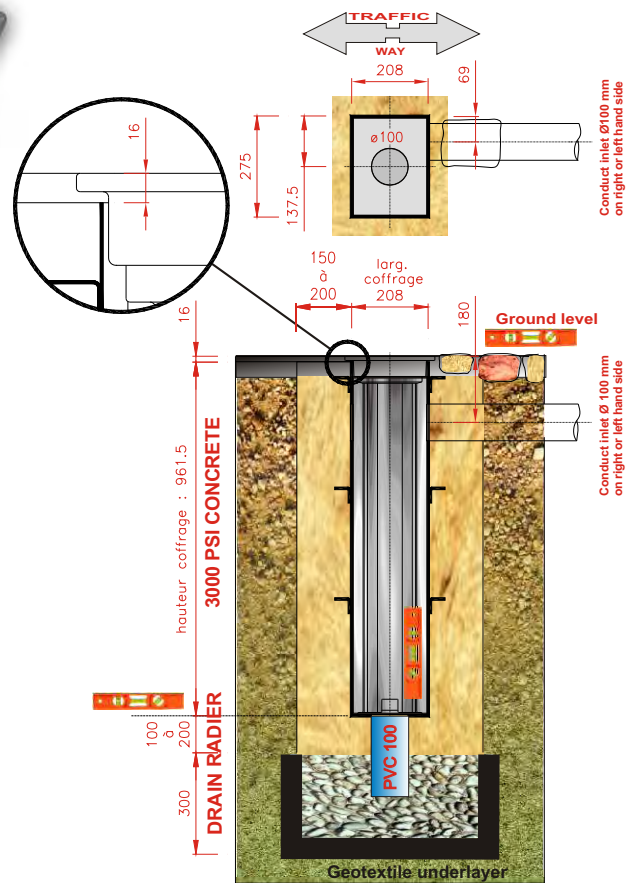
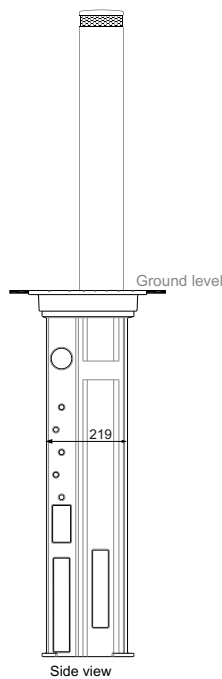
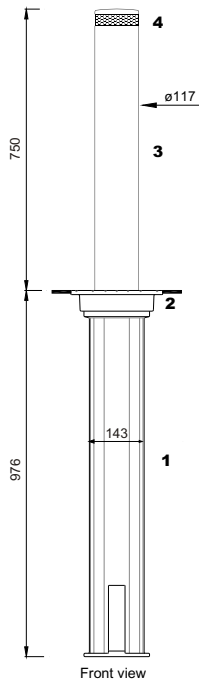

NOTA : Natural permeable soil for drainage.  
 (otherwise PVC tube should be connected to rainwater or sewage pipes)

**INSTALLATION PLAN**  
 for lost casing ref. BOCOFD960

Z.A. Du Couquiou - 84320 ENTRAIGUES - FRANCE  
 Tél. : (33) 04 90 48 08 08 - Fax : (33) 04 90 48 00 88  
 e-mail : urbaco@urbaco.fr

Propriété intellectuelle de URBACO - Ne peut être copié - Spécifications non contractuelles - Modifications possibles sans préavis

URBACO

# Technical sheet

Pneumatic mechanical retractable bollard

**CYLINDER Model Ø200/8", Height 500/20"**

Réf. BMCLPE50



Impact resistance	Weight	
5,000 joules	85 Kg/187.93 lb	
Material	Thickness	Colors
Cast steel	11 mm/0.4"	Standard URBACO paint RAL colors (optional)
Opening of Access		Closing of Access
1- Unlock with the key 2- With the push of a foot the bollard retracts in the casing		1- Turn the key back The bollard raises and automatically locks in the up position.

Z.A. Du Couquiou - 84320 ENTRAIGUES - FRANCE  
Tél. : (33) 04 90 48 08 08 - Fax : (33) 04 90 48 00 88  
e-mail : urbaco@urbaco.fr

URBACO

# Technical sheet

**Pneumatic automatic retractable bollard**

**CYLINDER Model Ø200/8", Height 500/20"**



Réf. BPCLE50

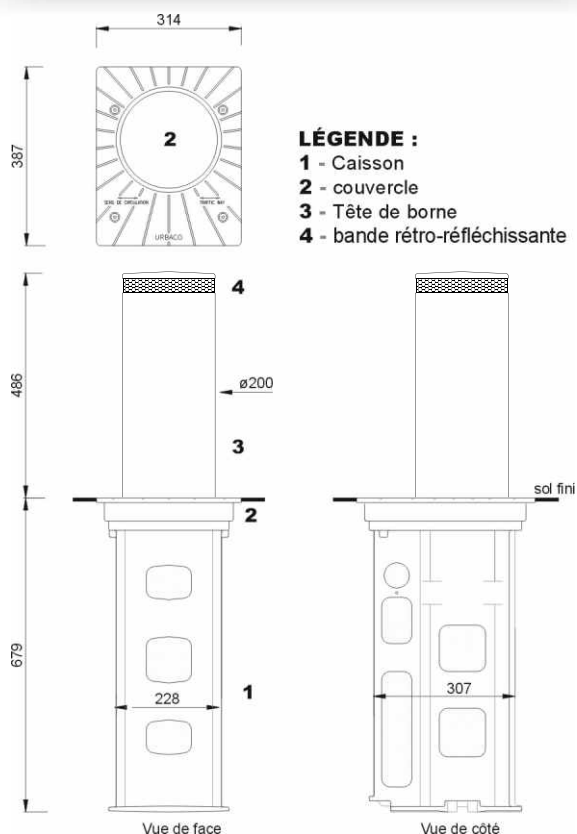

Impact resistance	Tested durability	Weight
5,000 joules	4.5 Million operation cycles	87 Kg/192 lb
Material	Thickness	Colors
Cast steel	11 mm/0.4"	Standard URBACO paint RAL colors (optional)
Fittings		Functioning
<ul style="list-style-type: none"> <li>- Lower limit switch</li> <li>- I.P.67 air distribution set (with valve 25m/27.3 yards air tube and connections).</li> </ul>		According to PLC program. The user will lower the bollard with a proximity card, remote control, digital keypad, etc. The bollard will automatically or manually rise again.

Z.A. Du Couquiou - 84320 ENTRAIGUES - FRANCE  
 Tél. : (33) 04 90 48 08 08 - Fax : (33) 04 90 48 00 88  
 e-mail : urbaco@urbaco.fr



# Technical sheet

Pneumatic automatic retractable bollard

**CYLINDER Model Ø 200/8", Height 750/30"**

Ref. BPCLPE75



Impact resistance	Tested durability	Weight
5,000 joules	4.5 Million operation cycles	115 Kg/253.53 lb
Material	Thickness	Colors
Cast steel	11 mm/0.4"	Standard URBACO paint RAL colors (optional)
Fittings		Functioning
<ul style="list-style-type: none"> <li>- Lower limit switch</li> <li>- I.P.67 air distribution set (with valve 25m/23.7yars air tube and connections).</li> </ul>		According to PLC program. The user will lower the bollard with aproximity card, remote control, digital keypad, etc. The bollard will automatically or manually rise again.

Z.A. Du Couquiou - 84320 ENTRAIGUES - FRANCE  
 Tél. : (33) 04 90 48 08 08 - Fax : (33) 04 90 48 00 88  
 e-mail : urbaco@urbaco.fr



# Technical sheet

**Pneumatic automatic retractable bollard**  
**CYLINDER Model Ø 200/8", Height 750/30"**



Ref. BPCLE75

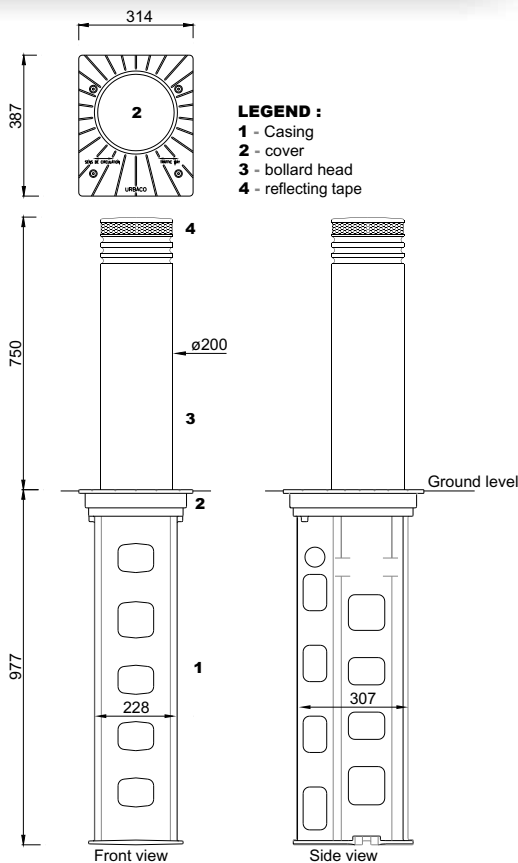

<b>Impact resistance</b>	<b>Tested durability</b>	<b>Weight</b>
5,000 joules	4.5 Million operation cycles	115 Kg/253.53 lb
<b>Material</b>	<b>Thickness</b>	<b>Colors</b>
Cast steel	11 mm/0.4"	Standard URBACO paint RAL colors (optional)
<b>Fittings</b>		<b>Functioning</b>
- Lower limit switch - I.P.67 air distribution set (with valve 25m/27.3 yars air tube and connections).		According to PLC program. The user will lower the bollard with a proximity card, remote control, digital keypad, etc. The bollard will automatically or manually rise again.

Z.A. Du Couquiou - 84320 ENTRAIGUES - FRANCE  
 Tél. : (33) 04 90 48 08 08 - Fax : (33) 04 90 48 00 88  
 e-mail : urbaco@urbaco.fr

Propriété intellectuelle de URBACO - Ne peut être copié - Spécifications non contractuelles - Modifications possibles sans préavis

**URBACO**

# Technical sheet

**Pneumatic automatic retractable bollard**  
**CYLINDER Model Ø250/10", Height 500/20"**

**Réf. BPCLPF50T**



Tilted cover

Impact resistance	Tested durability	Weight
9,000 joules	4.5 Million operation cycles	142 Kg/313.06 lb
Material	Thickness	Colors
Cast steel	11 mm/0.4"	Standard URBACO paint RAL colors (optional)
Fittings		Functioning
<ul style="list-style-type: none"> <li>- Lower limit switch.</li> <li>- I.P.67 air distribution set (with valve 25m/27 years air tube and connections).</li> </ul>		According to PLC program. The user will lower the bollard with a proximity card, remote control, digital keypad etc. The bollard will automatically or manually rise again.

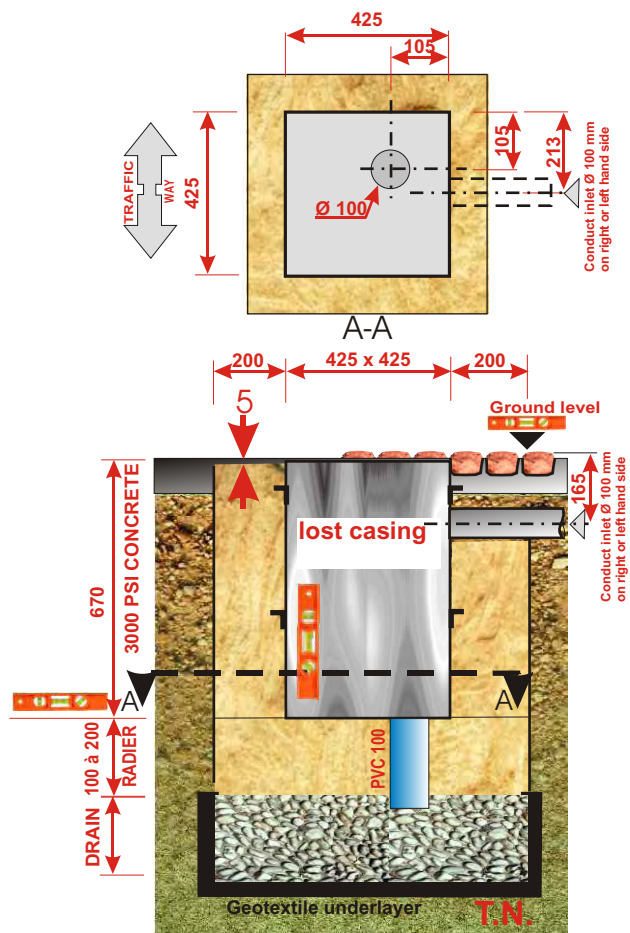
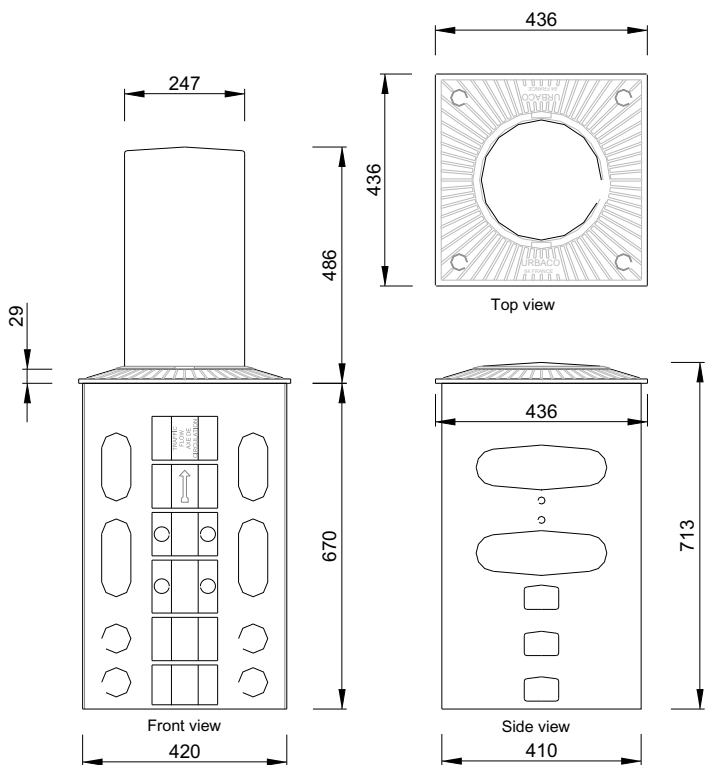

**NOTA : Natural permeable soil for drainage.**  
 (otherwise PVC tube should be connected to rainwater or sewage pipes)

**INSTALLATION PLAN**  
 for lost casing réf. BOCOFF700

Propriété intellectuelle de URBACO - Ne peut être copié - Spécifications non contractuelles - Modifications possibles sans préavis





# Technical sheet

**Pneumatic Automatic retractable bollard**

**Modèle CYLINDER Ø 250 / H 600 lumineuse**

**Ref. BPCLPF60C**



Impact resistance	Tested durability	Weight
9,000 joules	4,5 Million operation cycles	191 Kg/421.08 lb
Material	Thickness	Colors
Cast steel	11 mm/0.4"	Standard URBACO paint RAL colors (optional)
Fittings		Functioning
- Lower limit switch - I.P.67 air distribution set (with valve 25m/27.3 years air tube and connections). - bollard head with LED ring		According to PLC program The user will lower the bollard with a proximity card, remote control, radio beeper, etc. The bollard will automatically or manually rise again

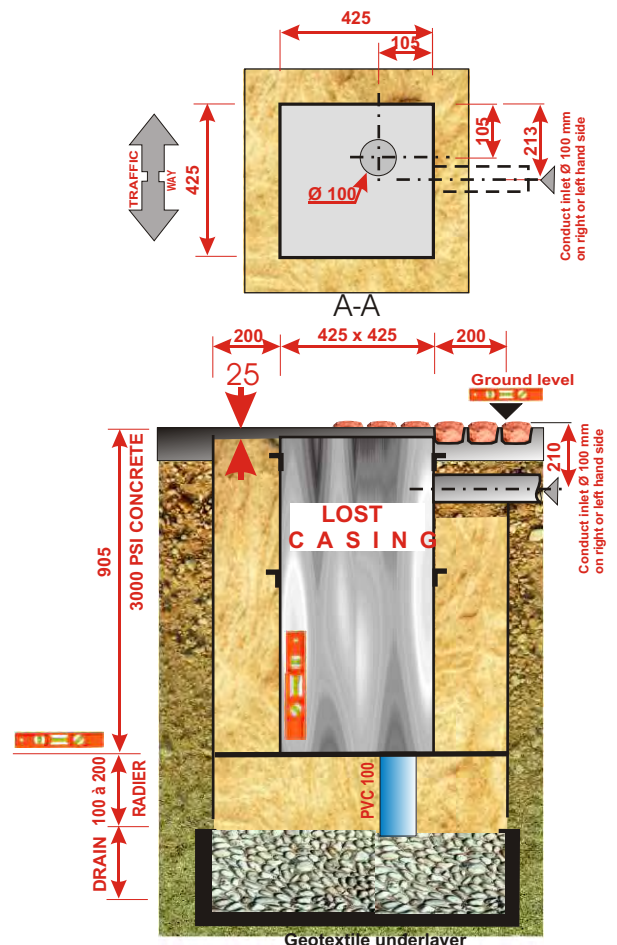
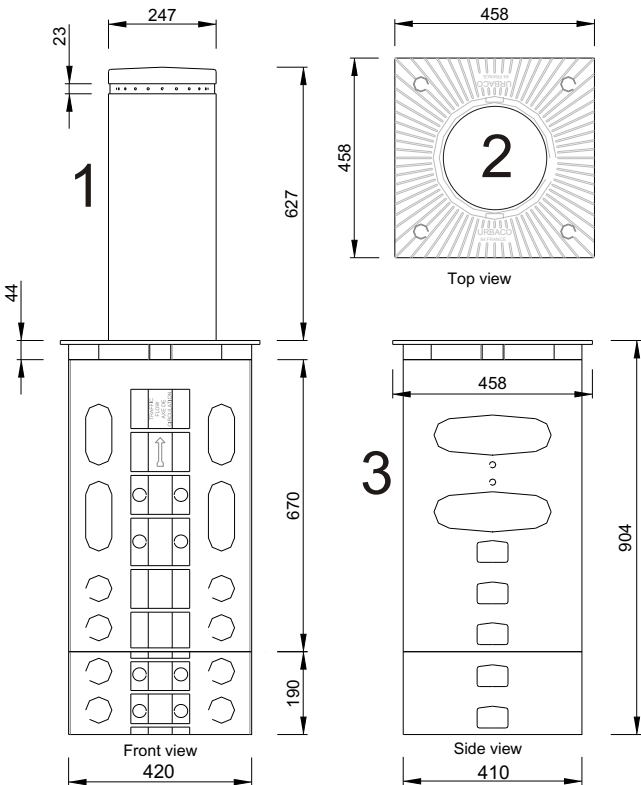

**Z.A. Du Couquiou - 84320 ENTRAIGUES - FRANCE**  
 Tél. : (33) 04 90 48 08 08 - Fax : (33) 04 90 48 00 88  
 e-mail : urbaco@urbaco.fr

**NOTA : Natural permeable soil for drainage.**  
 (otherwise PVC tube should be connected to rainwater or sewage pipes)

Propriété intellectuelle de URBACO - Ne peut être copié - Spécifications non contractuelles - Modifications possibles sans préavis

**URBACO**

# Technical sheet

**Pneumatic automatic retractable bollard**  
**CYLINDER Model Ø250/10", Height 750/30"**

**Ref. BPCLPF75**



<b>Impact resistance</b>	<b>Tested durability</b>	<b>Weight</b>
9,000 joules	4.5 Million operation cycles	160 Kg/352.74 lb
<b>Material</b>	<b>Thickness</b>	<b>Colors</b>
Cast steel	11 mm/0.4"	Standard URBACO paint RAL colors (optional)
<b>Fittings</b>	<b>Functioning</b>	
- Lower limit switch - I.P.67 air distribution set (with valve, 25m/27.3 years air tube and connections).	According to PLC program. The user will lower the bollard with a proximity card, remote control, digital keypad, etc. The bollard will automatically or manually rise again	

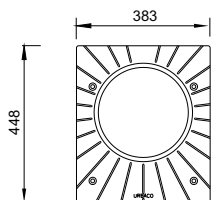

**LEGEND :**  
**1 - Casing**  
**2 - cover**  
**3 - bollard head**  
**4 - reflecting tape**

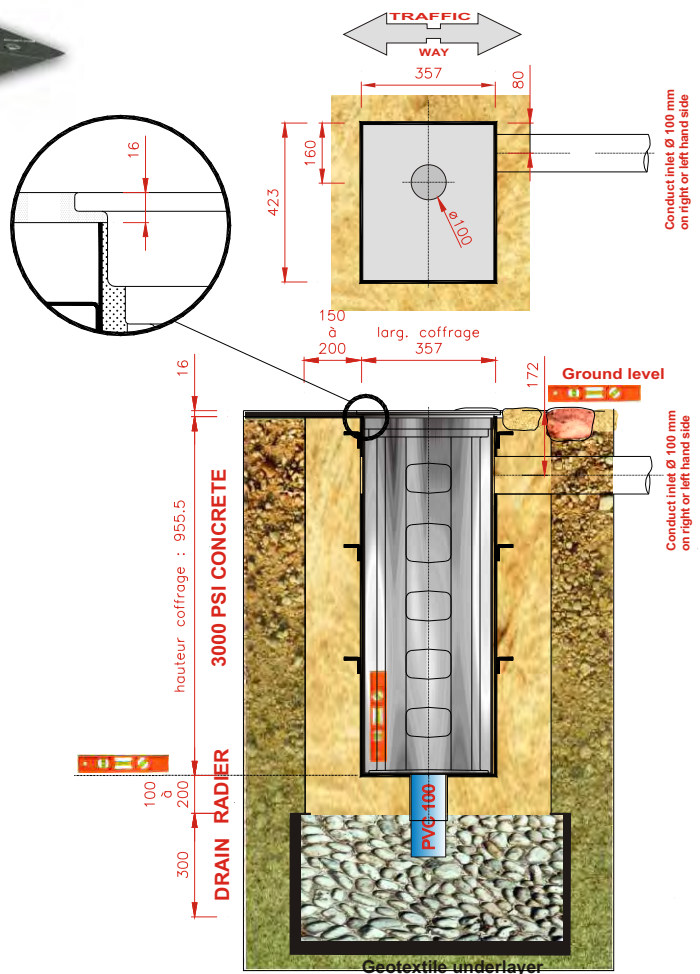
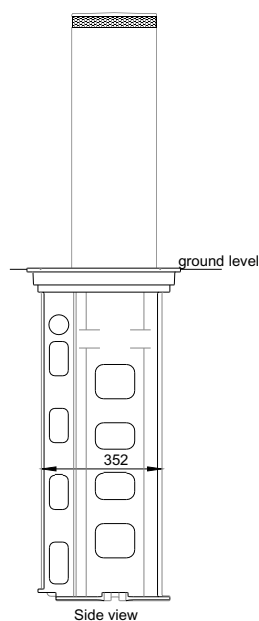
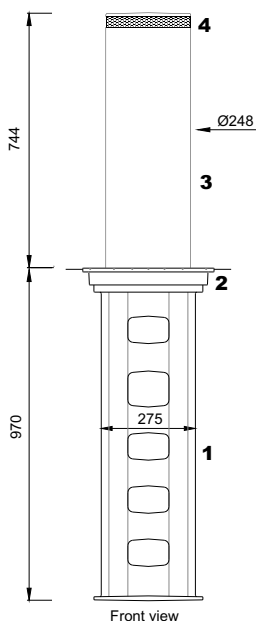

**NOTA : Natural permeable soil for drainage.**  
 (otherwise PVC tube should be connected to rainwater or sewage pipes)

**INSTALLATION PLAN**  
 for lost casing ref. BOCOFF954

**Z.A. Du Couquiou - 84320 ENTRAIGUES - FRANCE**  
**Tél. : (33) 04 90 48 08 08 - Fax : (33) 04 90 48 00 88**  
**e-mail : urbaco@urbaco.fr**

Propriété intellectuelle de URBACO - Ne peut être copié - Spécifications non contractuelles - Modifications possibles sans préavis