



# BALCONY

## Balcony Balustrade System 2 Installation Instructions

©Balcony Systems 2011

[www.balconette.co.uk](http://www.balconette.co.uk)

Tel: +44 1342 410411

Fax: +44 1342 410412

Unit 6, Systems House,  
Eastbourne Road,  
Blindley Heath, Lingfield,  
Surrey, RH7 6JP,  
United Kingdom

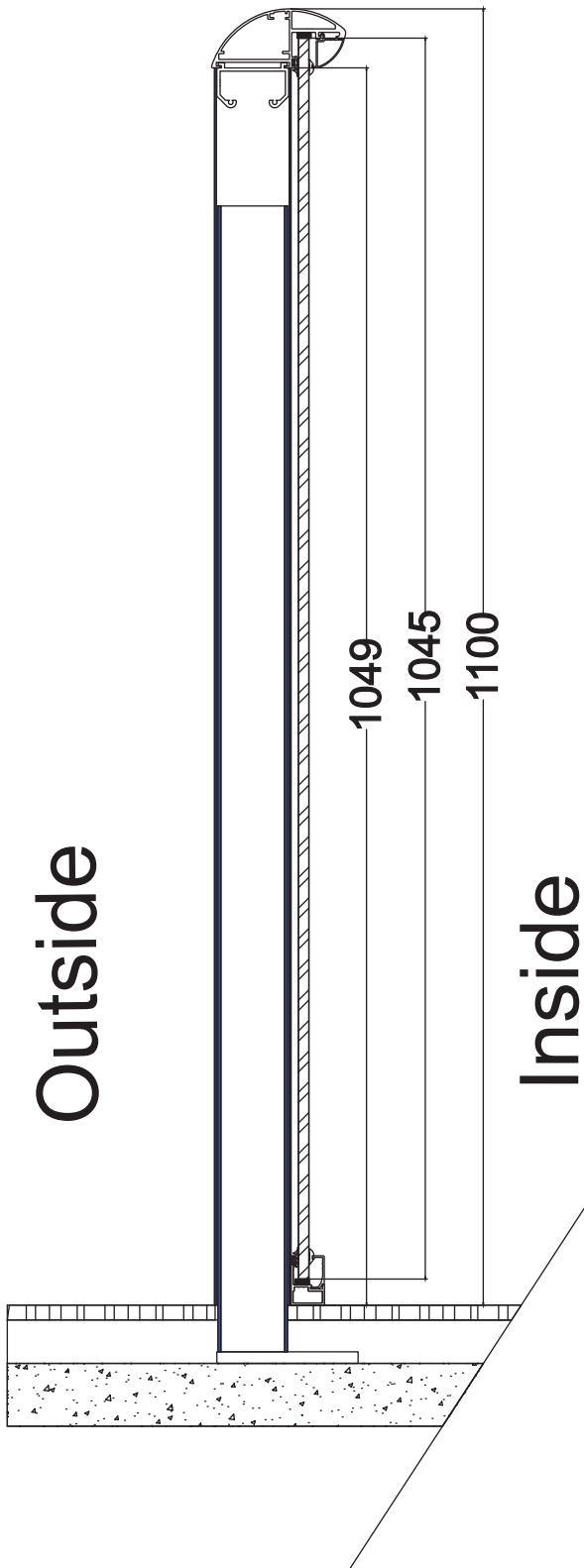

- 1) Check you have all the parts of the order.
- 2) Check the height of the glass
- 3) Check the height of the posts
- 4) Check both these heights against the required height on site making sure they are correct before assembling

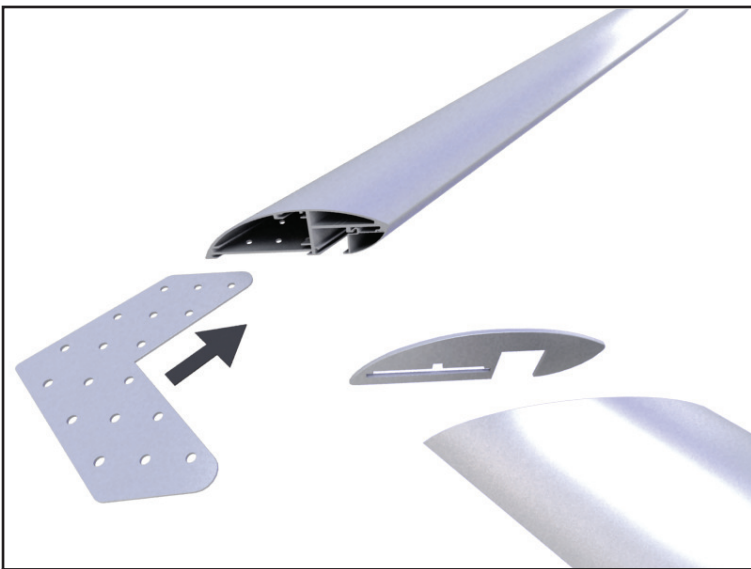

5 Prepare to assemble the handrail corner

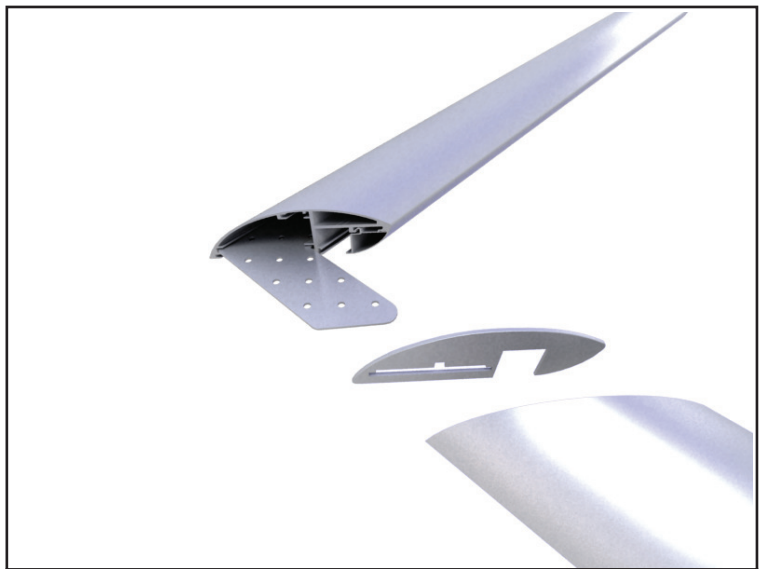

6 Slide corner joint plate into one of the handrails

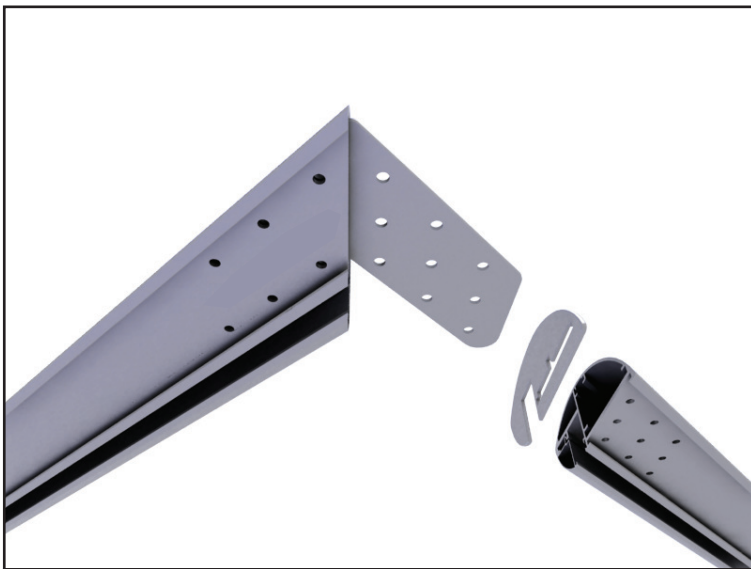

7 Tighten the screws

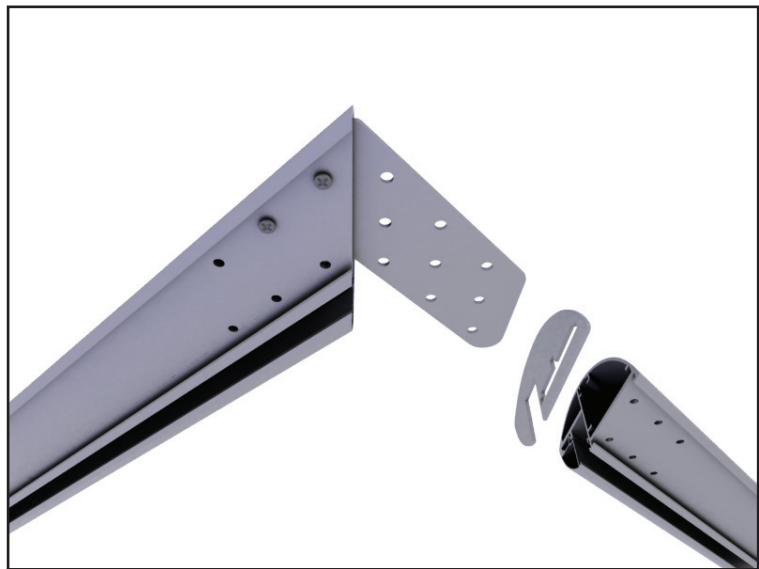

8 Tighten the screws

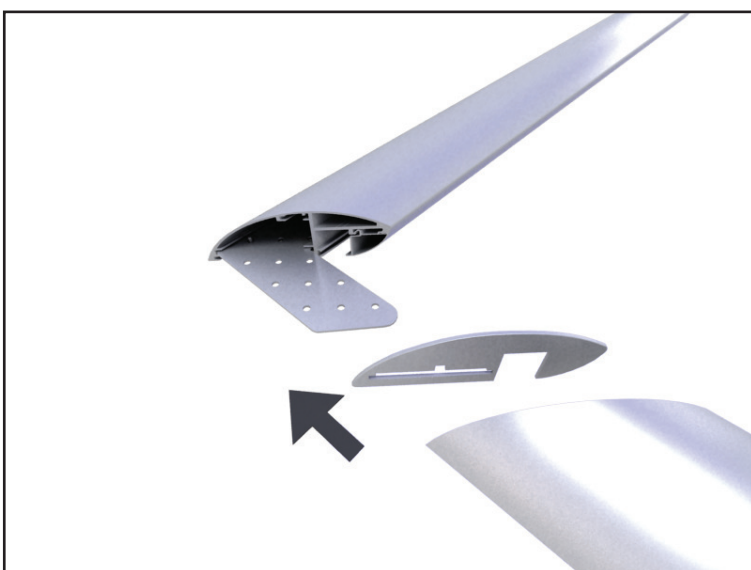

9 Slide mitre plate onto corner plate

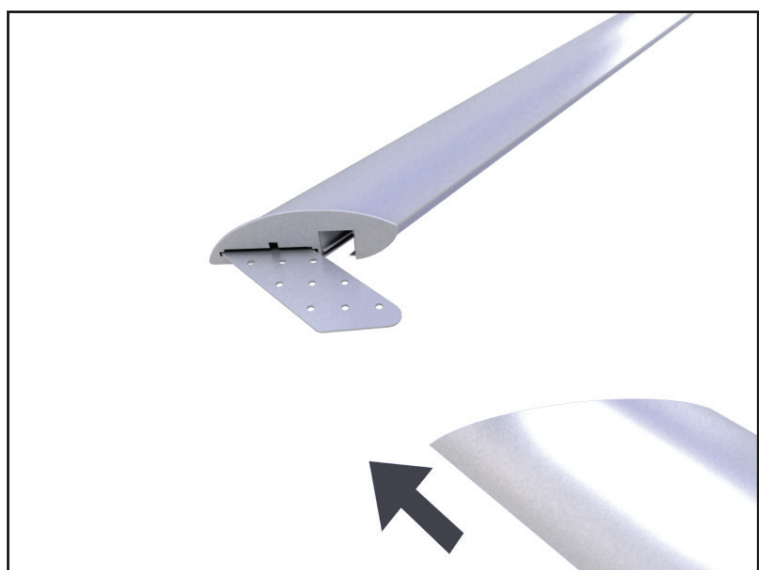

10 Bring handrail to butt up to mitre plate

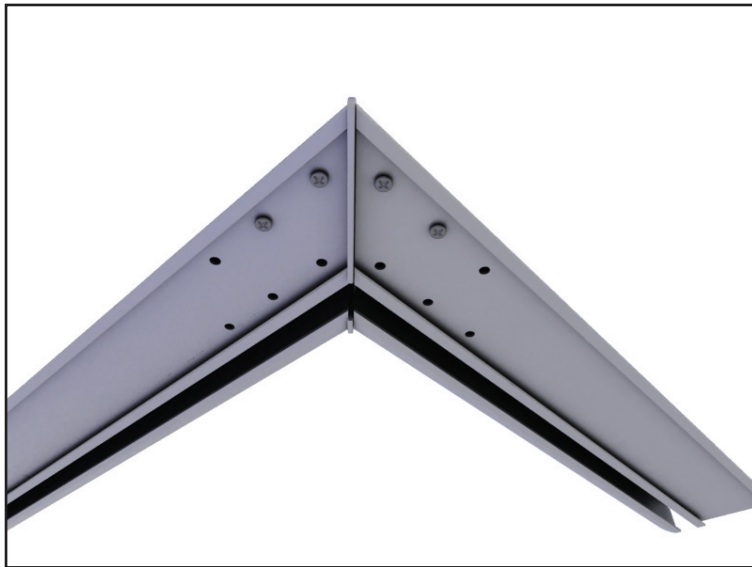

11 Tighten all screws

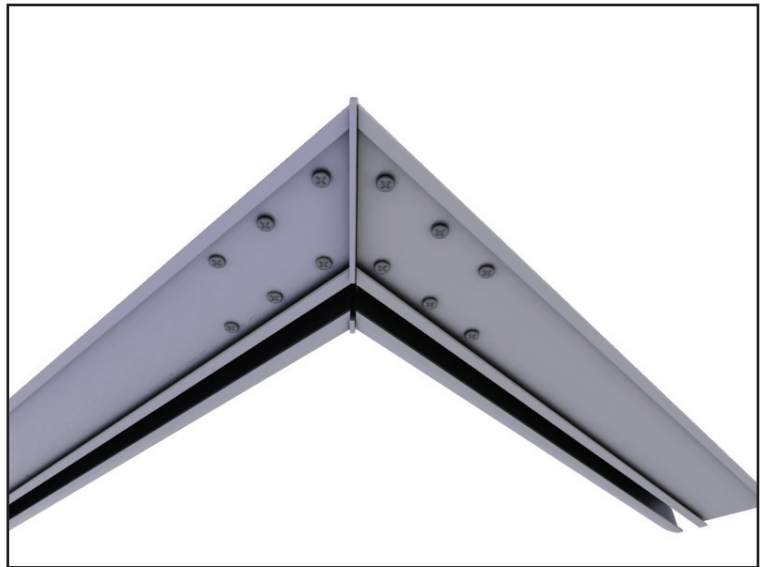

12 Tighten all screws. In this fashion join all handrail parts together.



13 Place handrail on the floor in position to make sure the dimension and shape fit

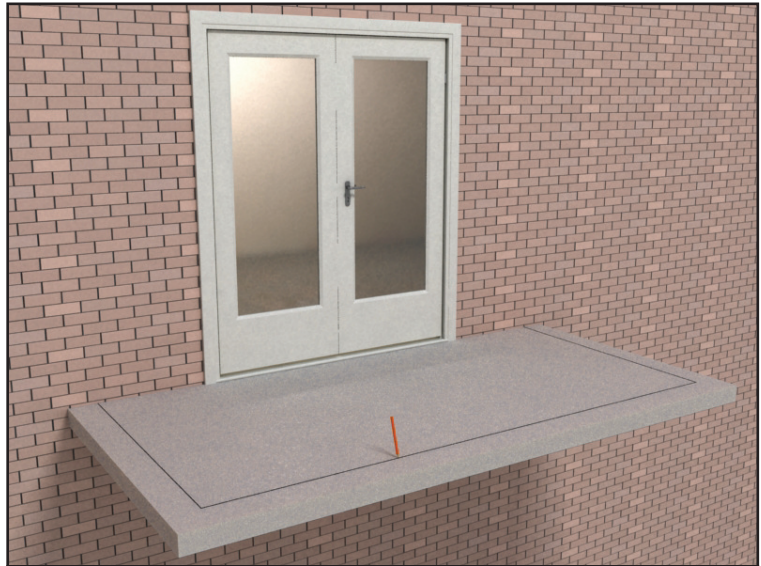

14 Mark lines for later positioning of bottom track



15 Position the primary steel post in the correct position

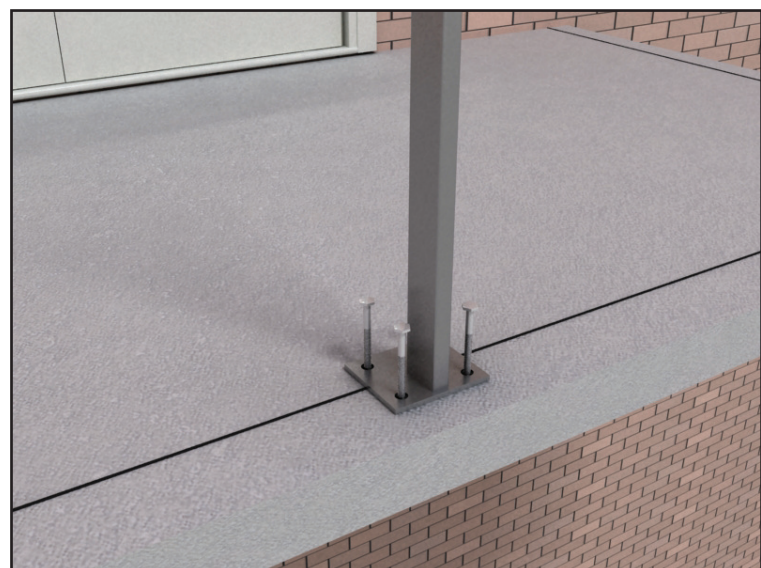

16 If vertical posts are required Position the primary steel post/s in the correct position/s

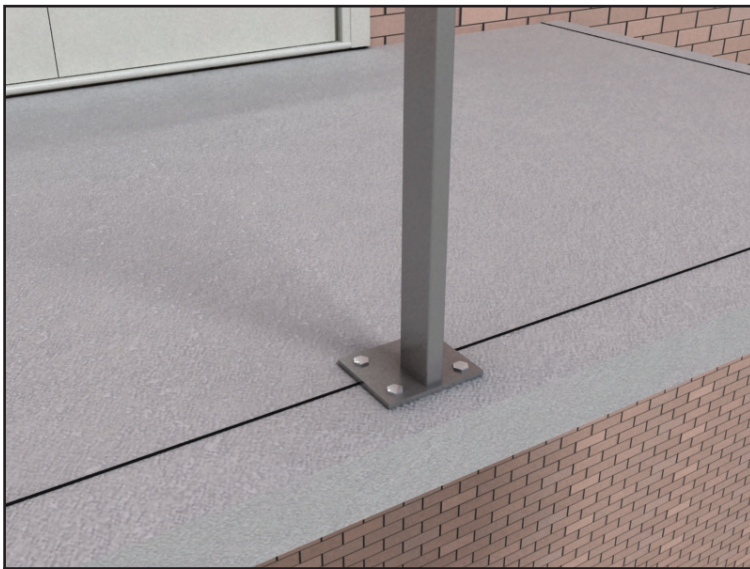

Use the appropriate fixings (Post fixing 17 can be done at primary stage by locating the posts using measurements)



Finish the flooring, decking, screed, floor finish etc. to the required height. This should conceal the base plate and bolts



Apply a thick bead of silicone sealant around the primary steel post in a spiral fashion



Slide the system cover post onto the primary post



Check that the system cover post is sitting on finished floor level.



Aluminium post in position

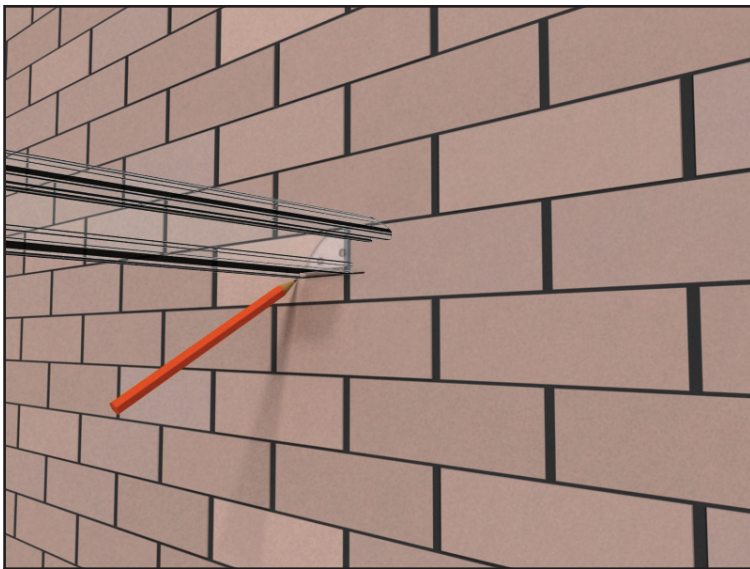

23 Using a level mark the position required to fix the wall fixing bracket.



24 Use the appropriate fixings.

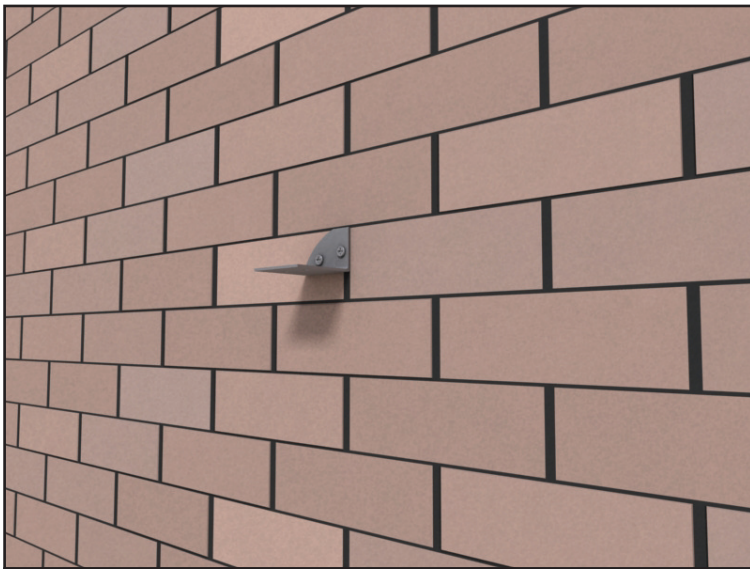

25 Secure the wall bracket to the wall.



26 Bring the handrail into position



27 Drop the handrail onto the angle bracket



28 Drill 4mm holes through brackets in the handrail. Fix the handrail to the wall bracket using the No. 10 x 3/4" S/tapping screws

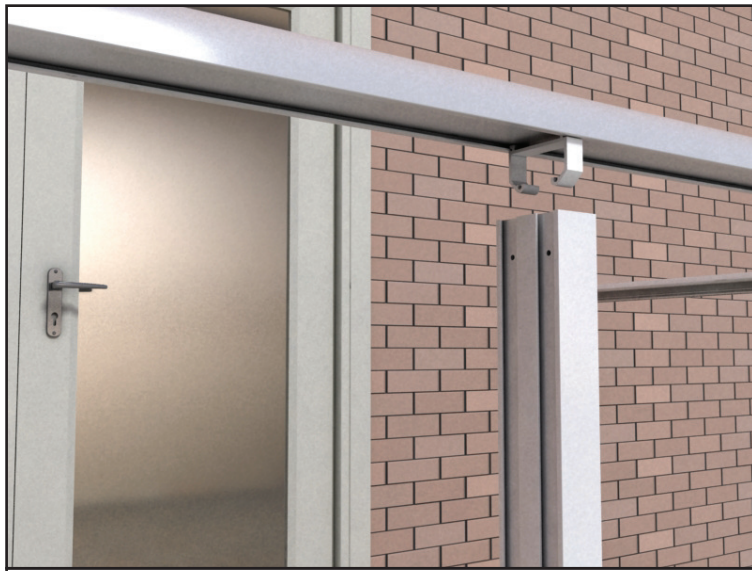

29 Handrail connector fits into top of post

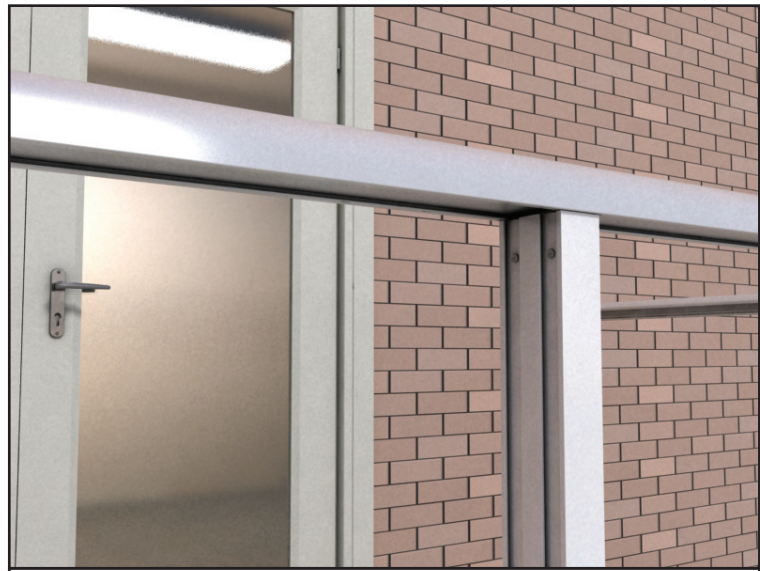

30 Fix the post into the post connector the No. 8 x1/2" S/tapping screws provided

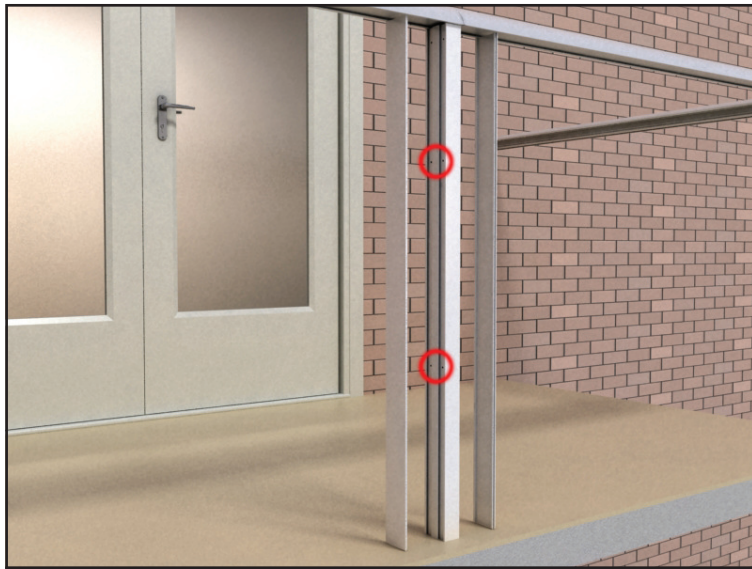

31 Drill and screw a few screws to fix the aluminum post to the primary post

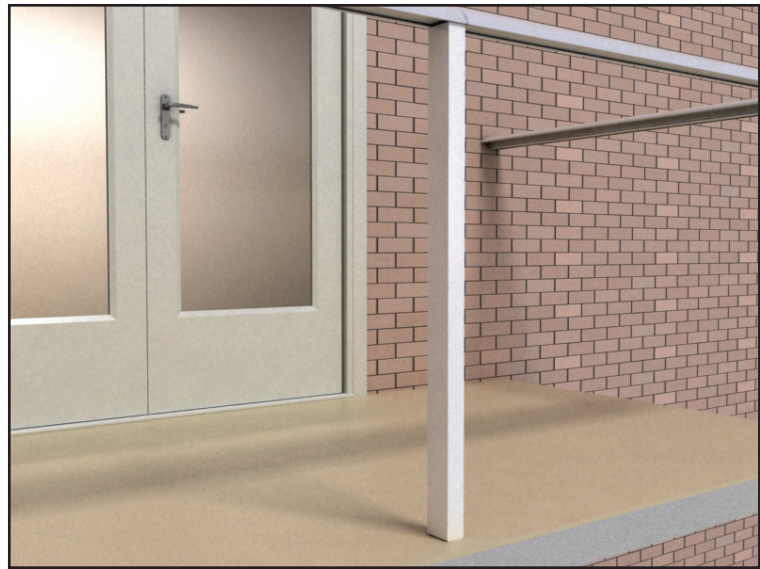

32 Place the aluminium post covers in position

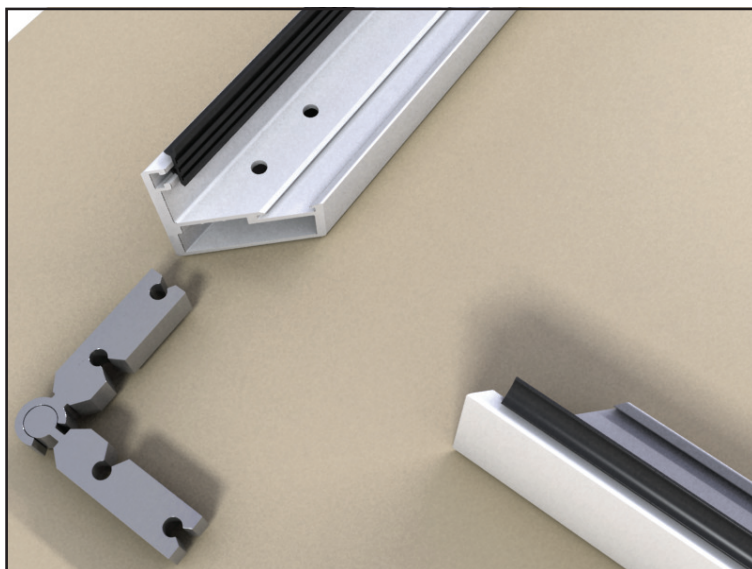

33 Prepare to assemble the bottom track

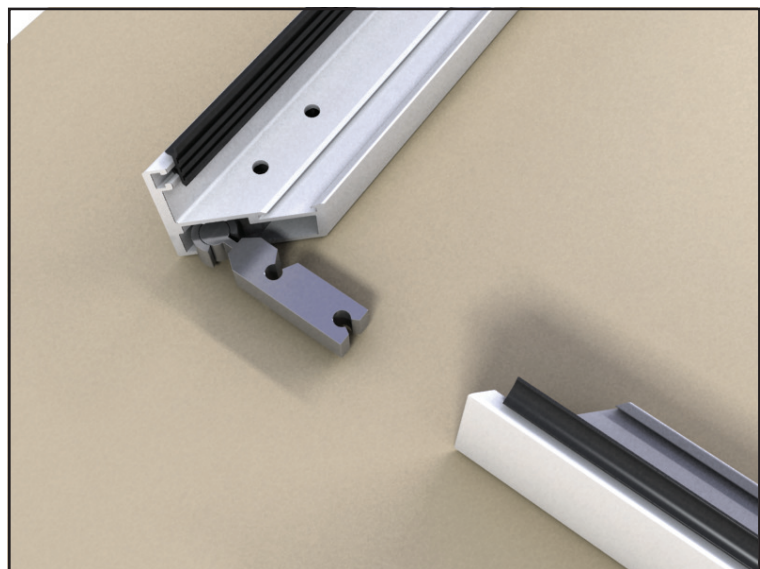

34 Slide the corner joint in one of the bottom rails. (the bottom rail corner joint is suitable on angles of 75' to 139')

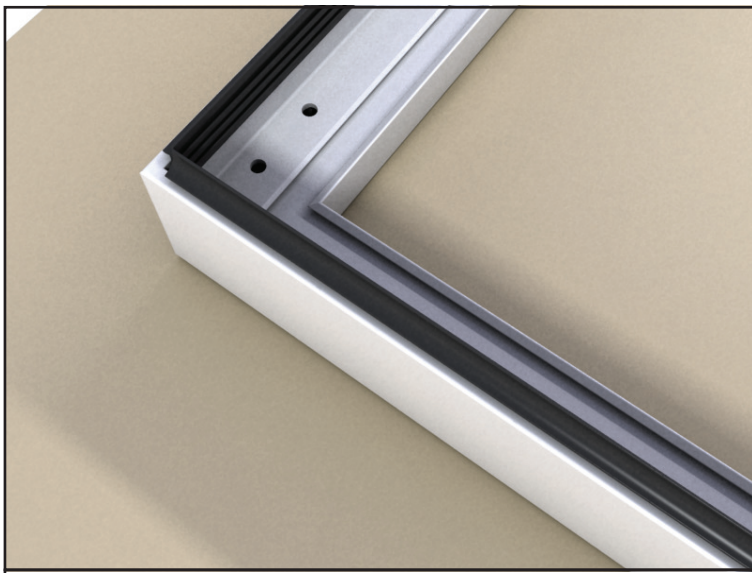

35 Insert into the other bottom rail corner

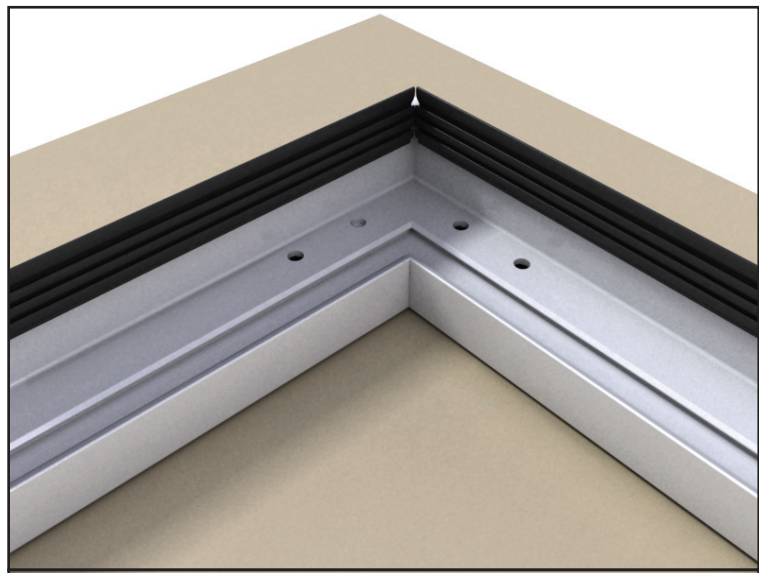

36 and tighten the screws

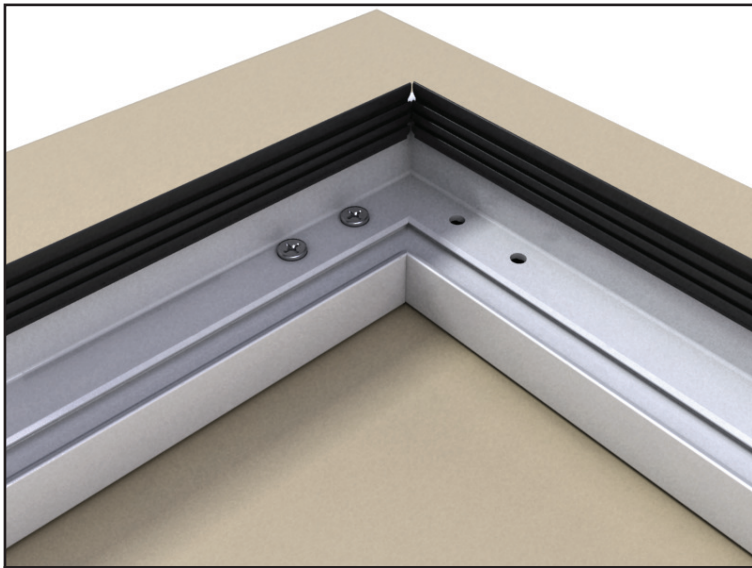

37

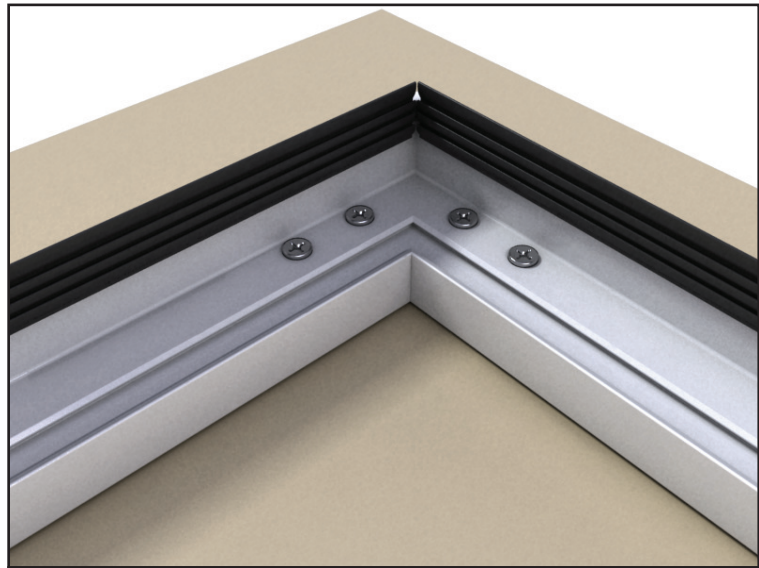

38

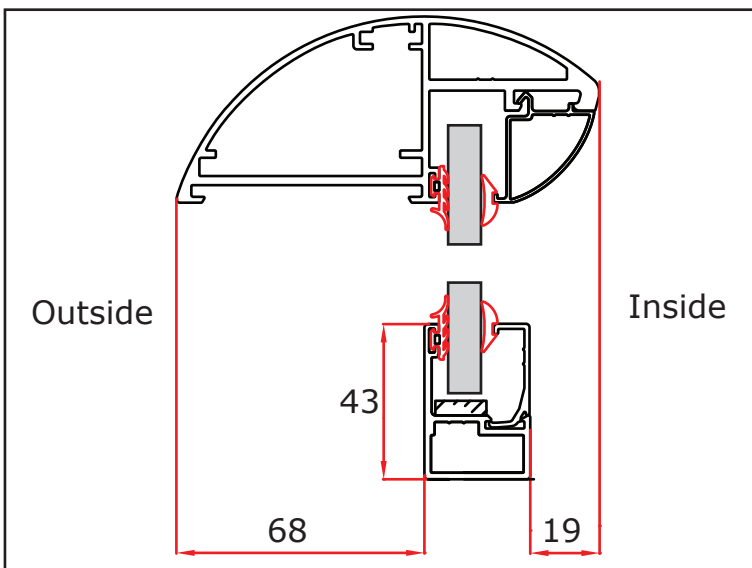

39 Use these dimensions to correctly line up handrail and bottom rail.



40 Place the bottom track into position.

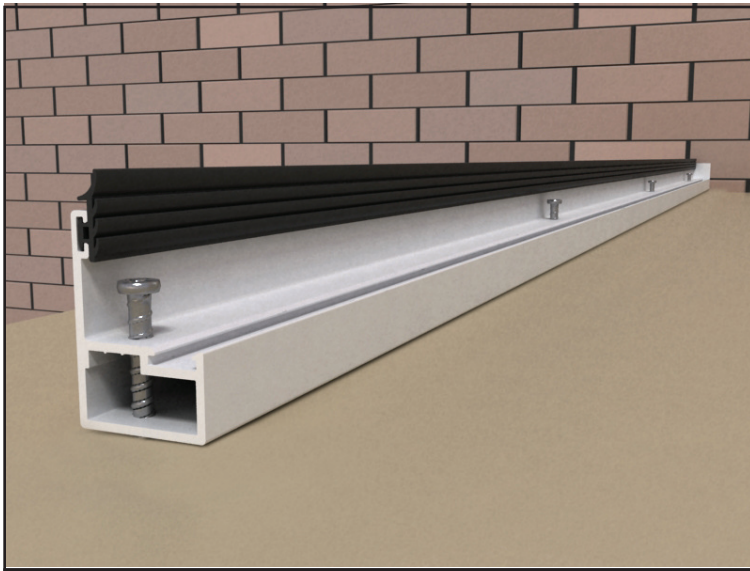

41 Drill into the floor/structure through the bottom rail to fix it.

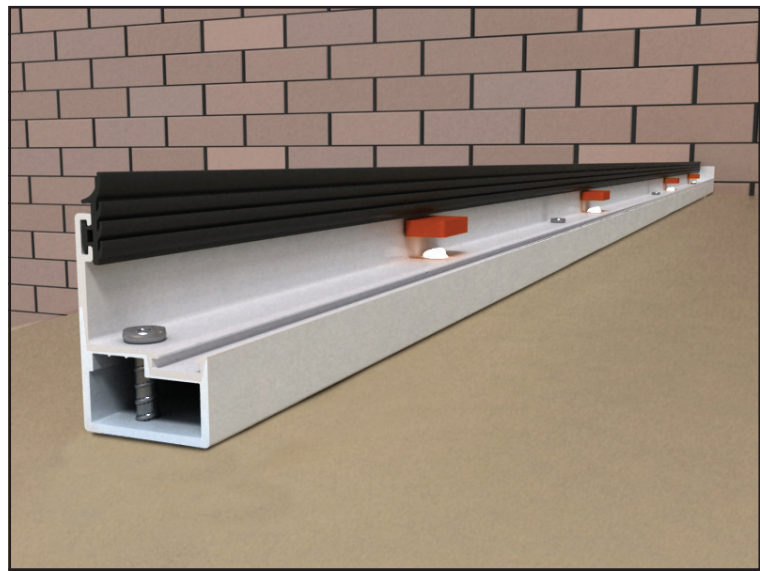

42 Place two 5mm (orange) spacers per required glass panel onto the bottom rail

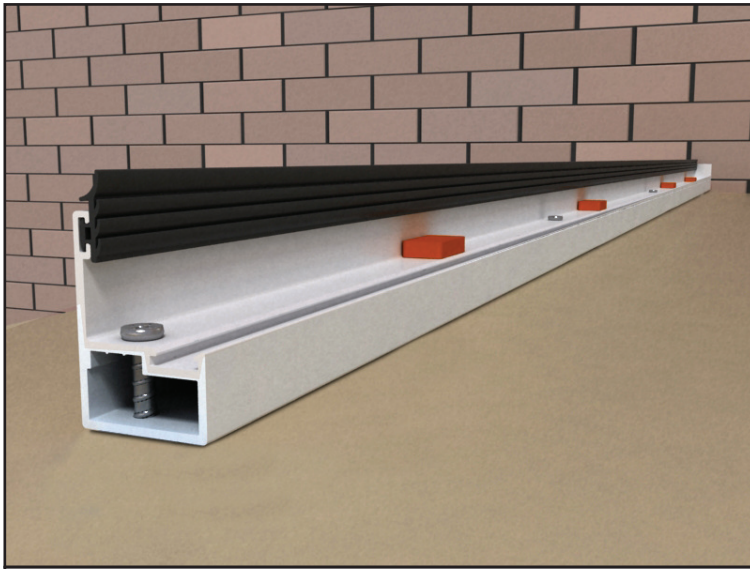

43 Use silicone to stick them to the bottom rail

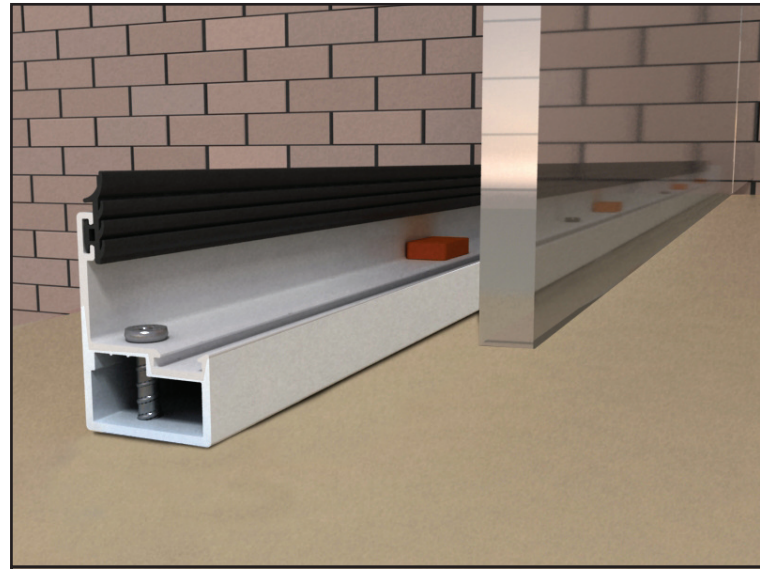

44 Identify glass sizes and where they are to go

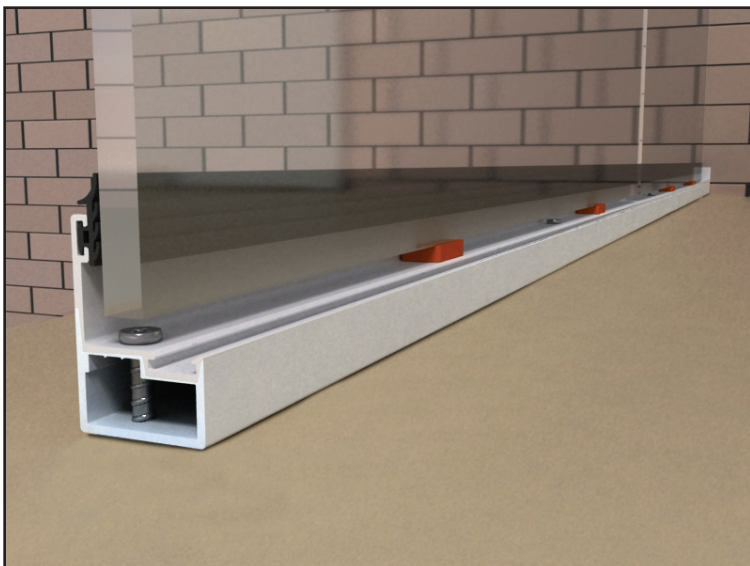

45 Place one glass panel at a time into position

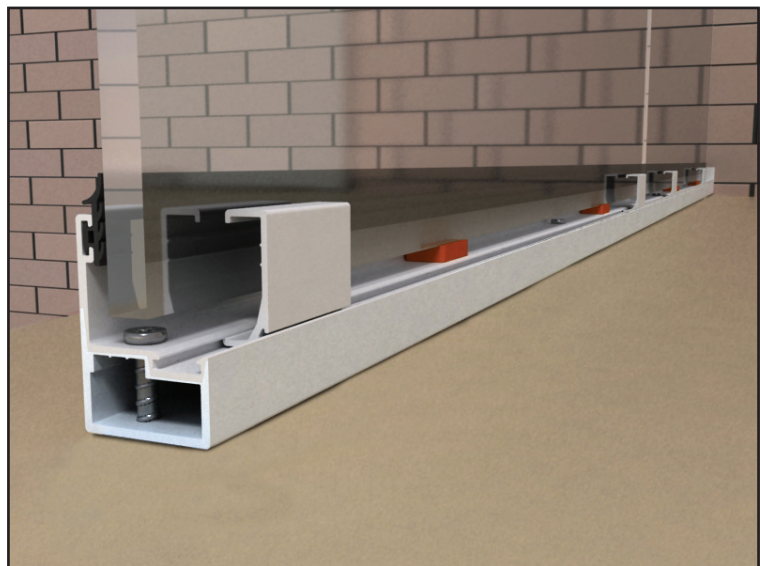

46 Use the short pieces of glazing bead to temporarily hold the glass in position



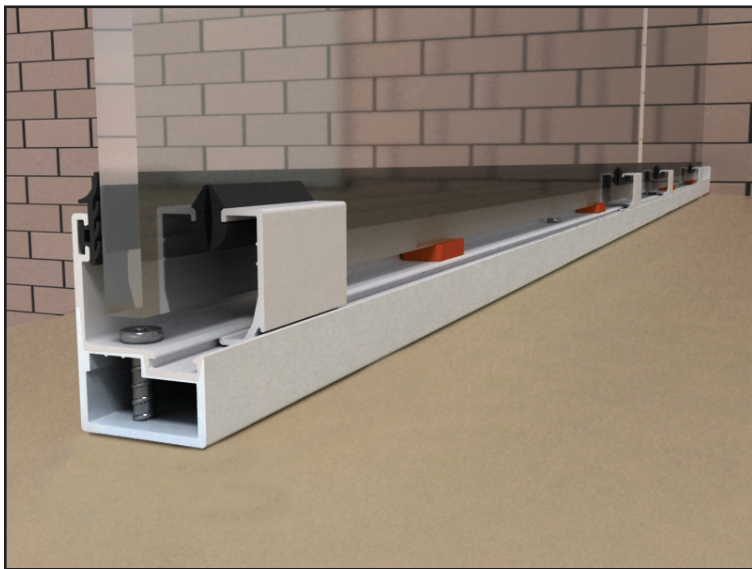

47 Use 3mm rubber gaskets to hold the glass against the small bead pieces



48 Place one glass panel at a time into position



49 Place the spacers so the handrail doesn't sit on the glass



50 Use the short pieces of glazing bead to temporarily hold the glass in position



51 Use 3mm rubber gaskets to hold the glass against the small bead pieces



52 Use 3mm rubber gaskets to hold the glass against the small bead pieces



53 Align all the glass panels to have correct gaps. Use the glazing packers to lift one side or the other if needed

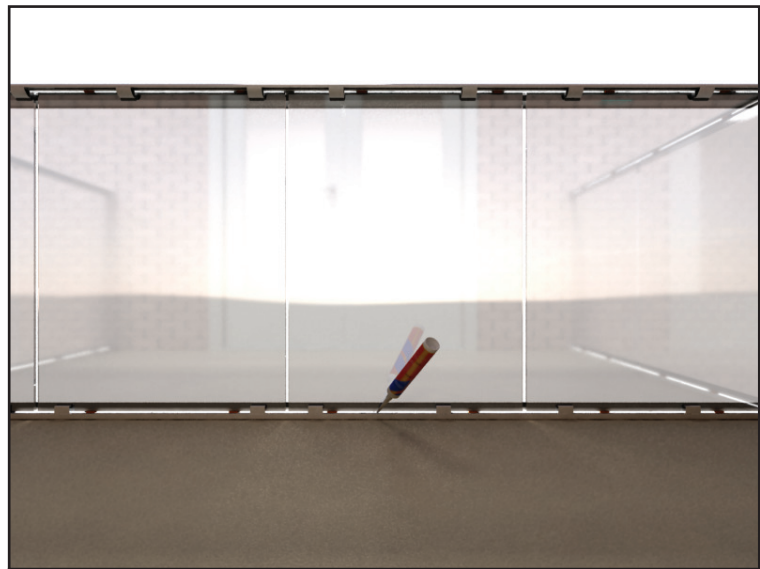

54 When everything lines up and all correct silicone it all.

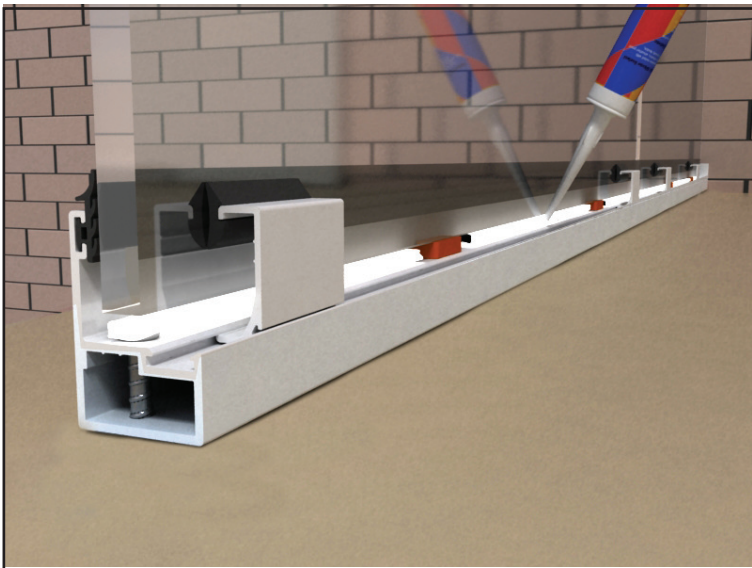

55 Apply a thick bead of high quality silicone sealant to continuously fill the gap between bottom of glass and bottom rail



56 Apply a thick bead of high quality silicone sealant to continuously fill the gap between top of glass and handrail

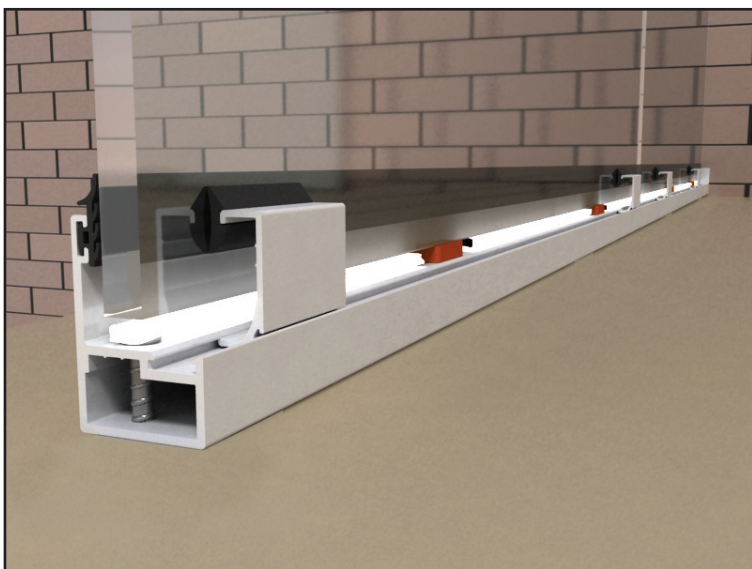

57 Wait until the silicone is completely dry



58 Wait until the silicone is completely dry

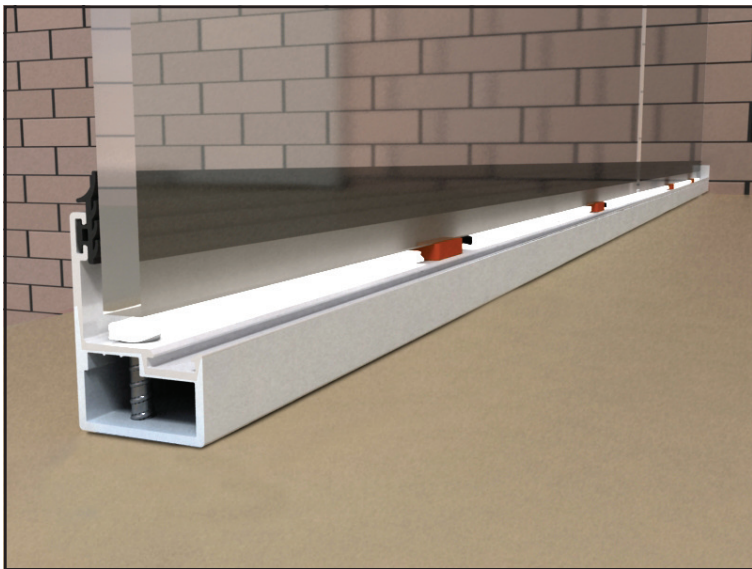

59 Remove the temporary glazing beads and rubber gaskets



60 Remove the temporary glazing beads and rubber gaskets

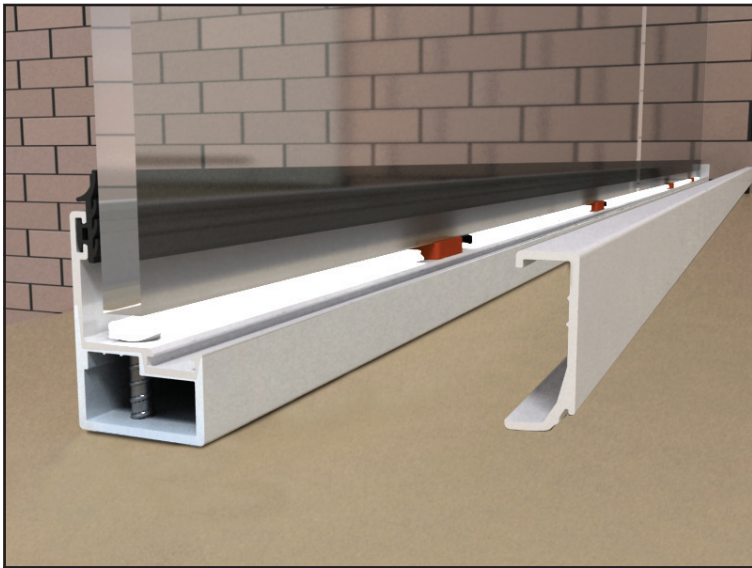

61 Replace the full length glazing beads



62 Replace the full length glazing beads

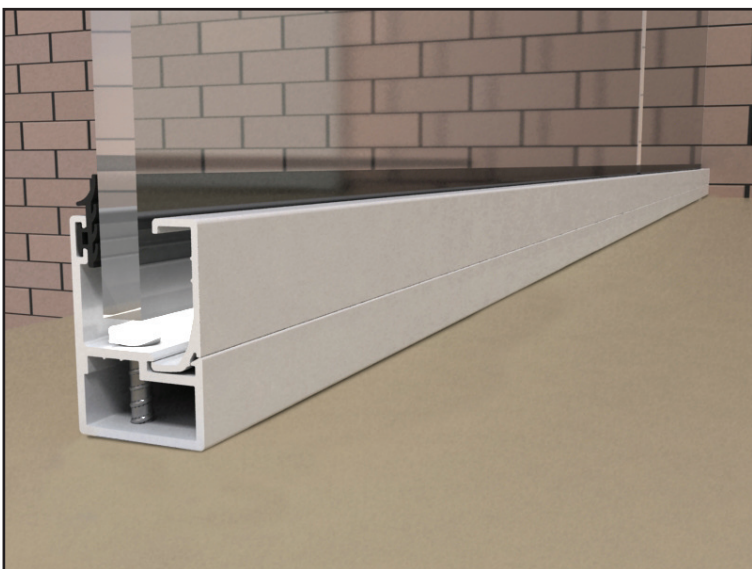

63 Replace the full length glazing beads



64 Replace the full length glazing beads

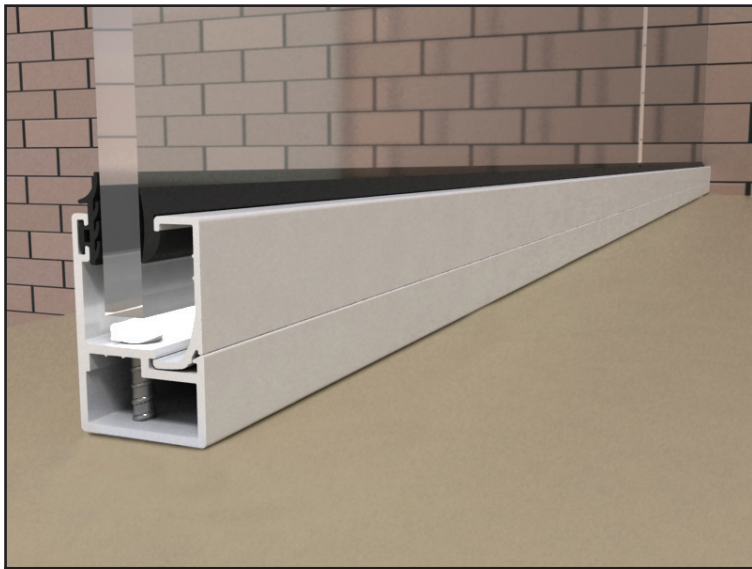

65 Strengthen the grip with rubber gaskets



66 Strengthen the grip with rubber gaskets

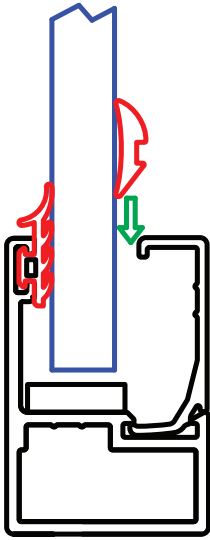

67 Using soapy water can make it easier to push rubber in

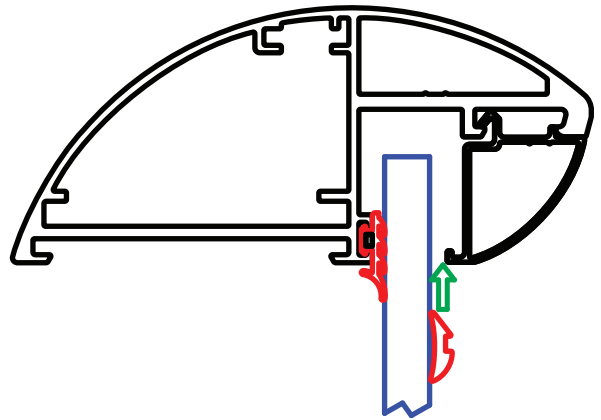

68 Using soapy water can make it easier to push rubber in

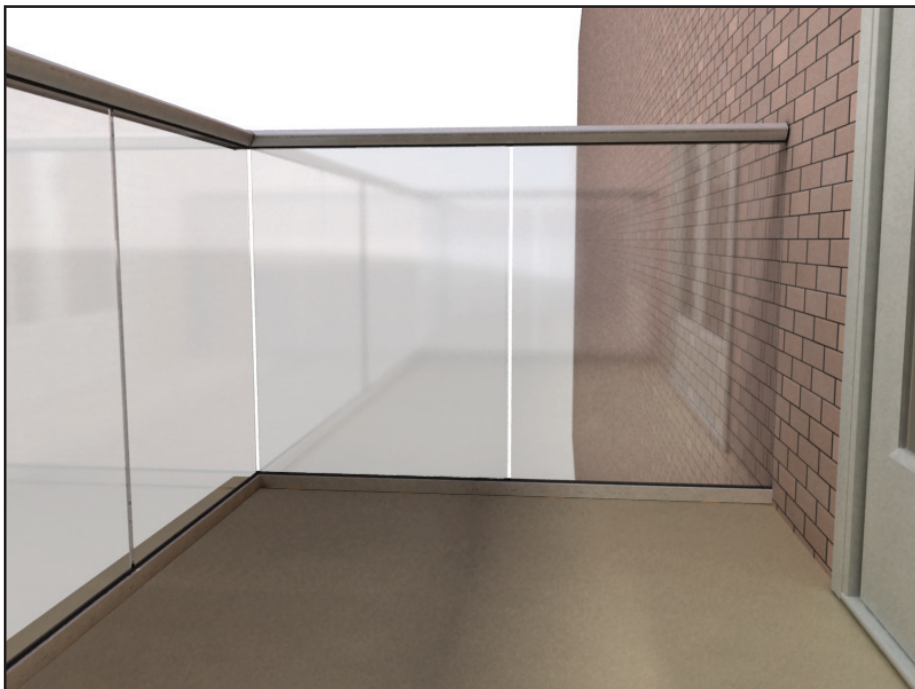

## Additional options

5mm packers under bottom rail

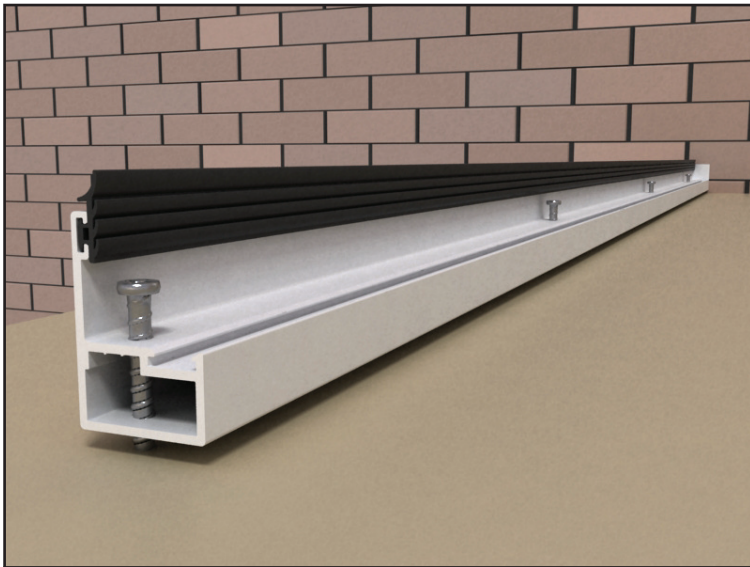

69\* Drill into the floor/structure through the bottom rail to fix it.

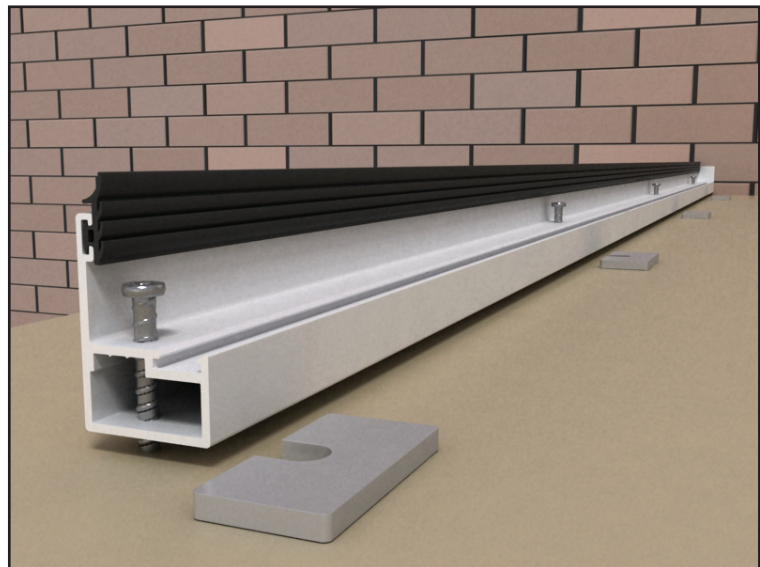

70\* If required, place 5mm aluminium spacers under the bottom rail

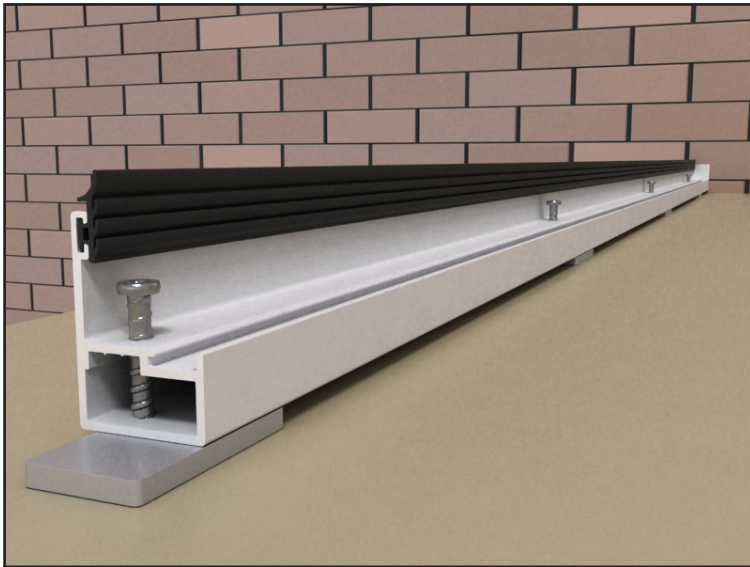

71\* Place the spacers so they meet up the screws

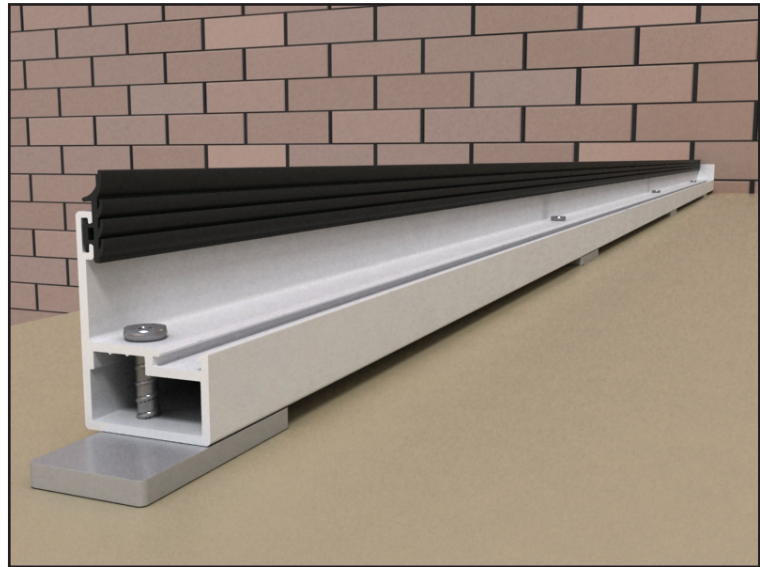

72\* Tighten bottom rail to the floor

## Additional options

### Curved handrails/balustrades

On occasion it is difficult or not possible to remove the glazing bead, in these cases follow this procedure

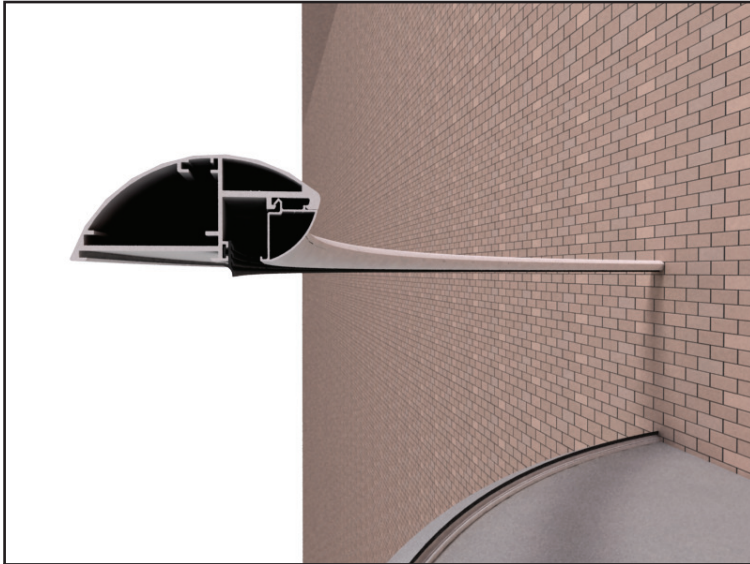

73\* Leave the handrail glazing bead in position

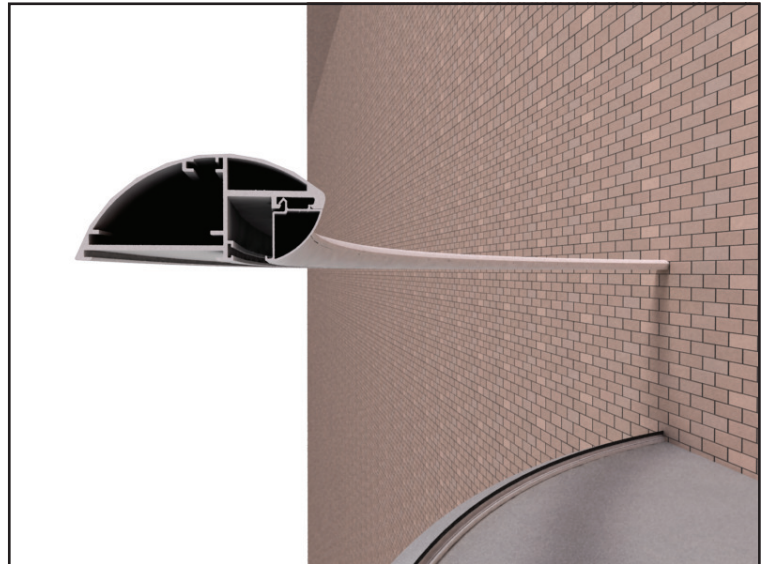

74\* Remove the rear fixed rubber from the handrail

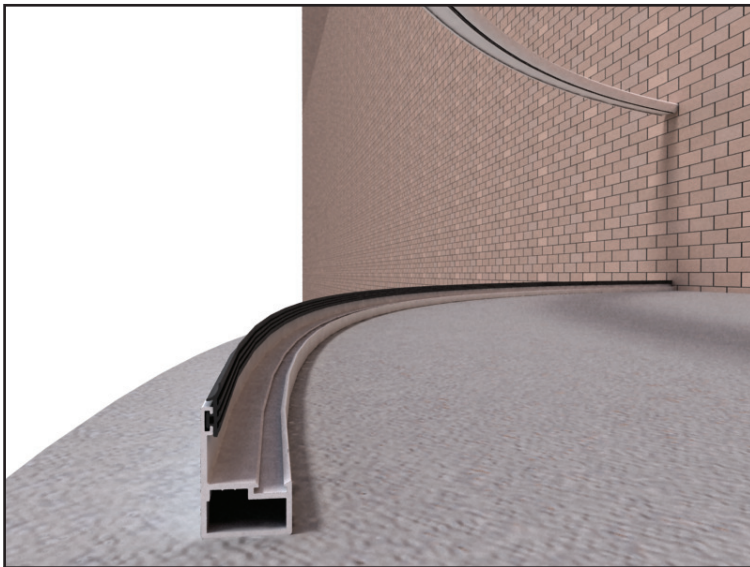

75\* Remove the glazing bead from the bottom rail

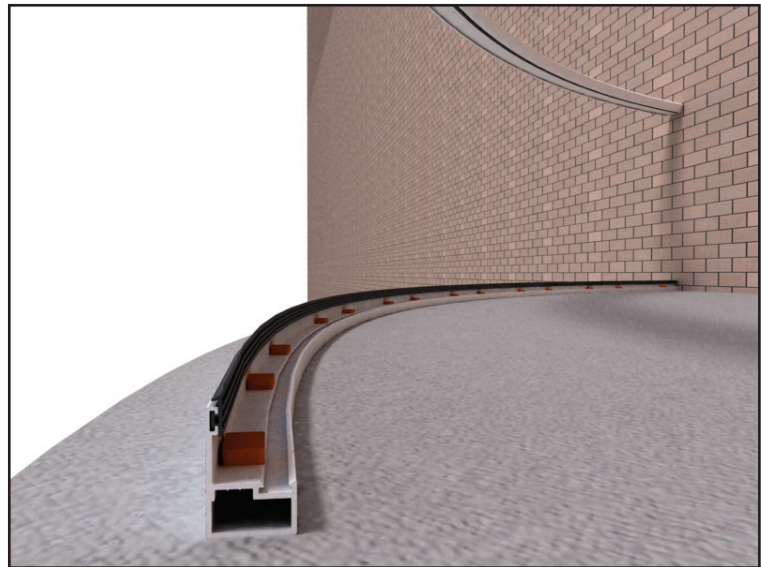

76\* Place two orange 5mm packers per glass on the bottom rail



77\* Identify the glass panels and where they should go



78\* Taking one glass at a time insert the panel upwards into the gap between the glazing bead and handrail

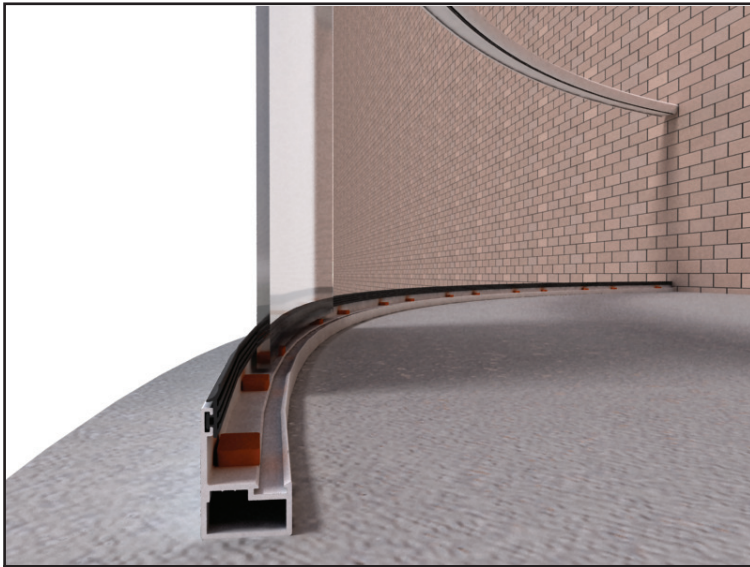

79\* Lower the glass back down onto the orange packers

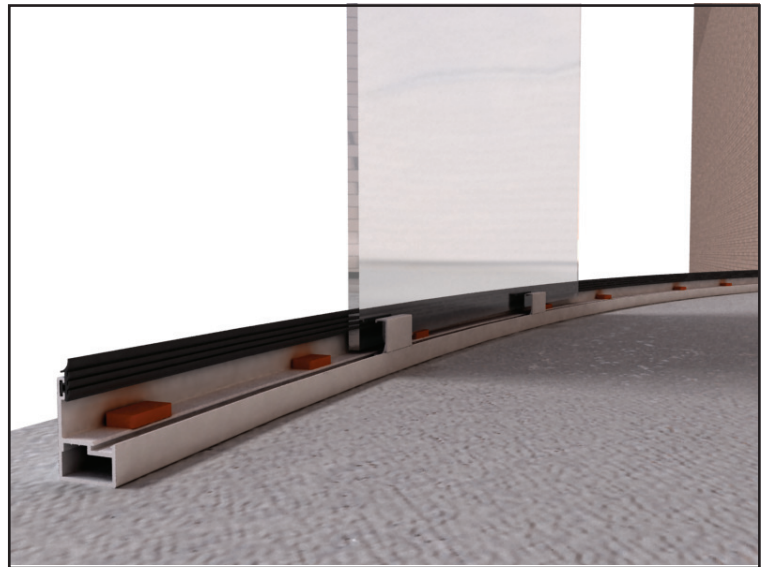

80\* Place small temporary glazing beads on the bottom rail, two per glass panel

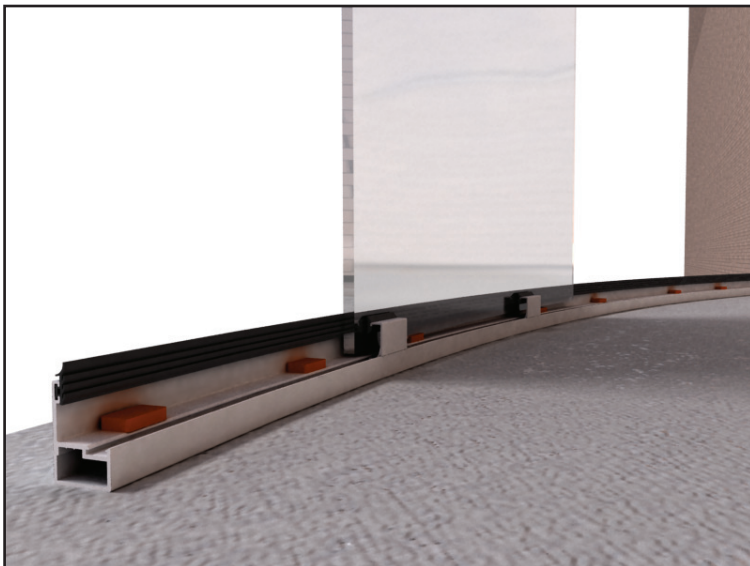

81\* Push in 3mm rubber to hold them firmly against the glass



82\* In this fashion, one at a time insert all the glass panels

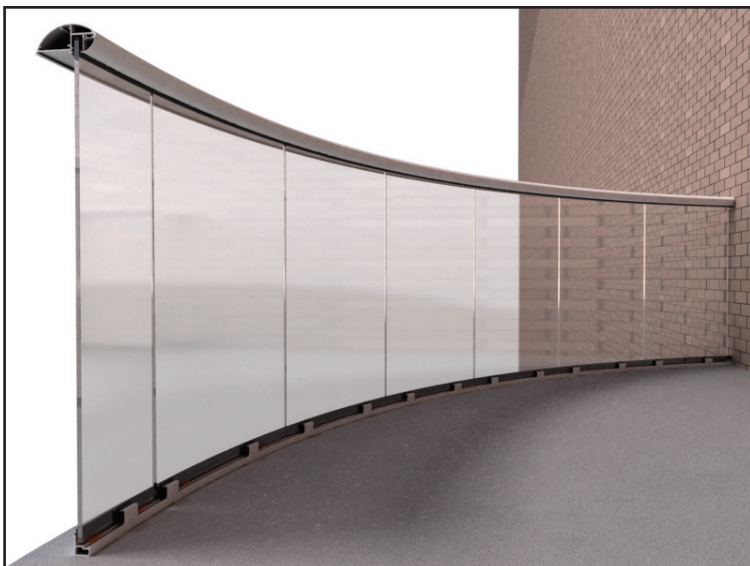

83\* Align all the panels and gaps

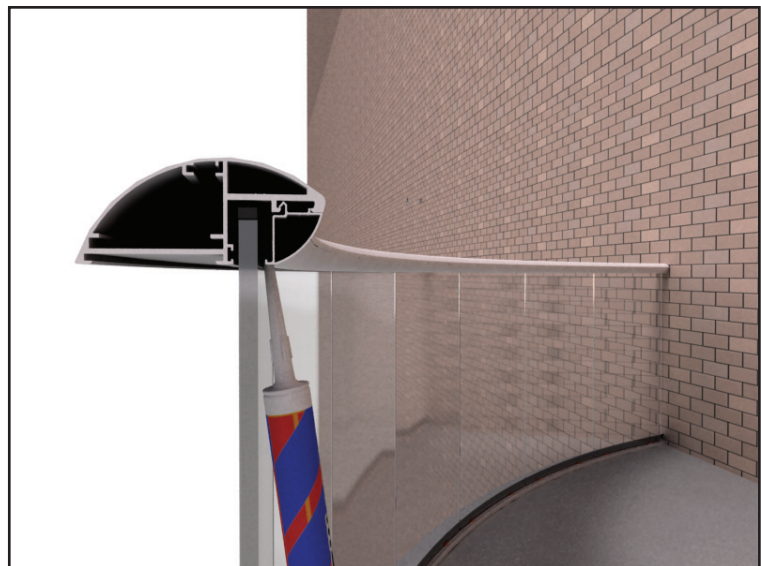

84\* Inject silicone by pushing the silicone nozzle into the gap between the bead and glass and pushing silicone upwards into the cavity

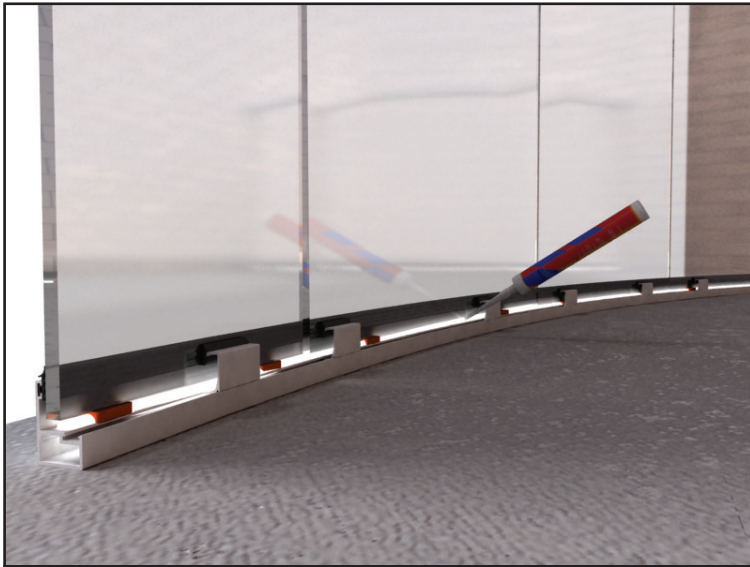

85\* Apply a thick bead of high quality silicone sealant to continuously fill the gap between bottom of glass and bottom rail

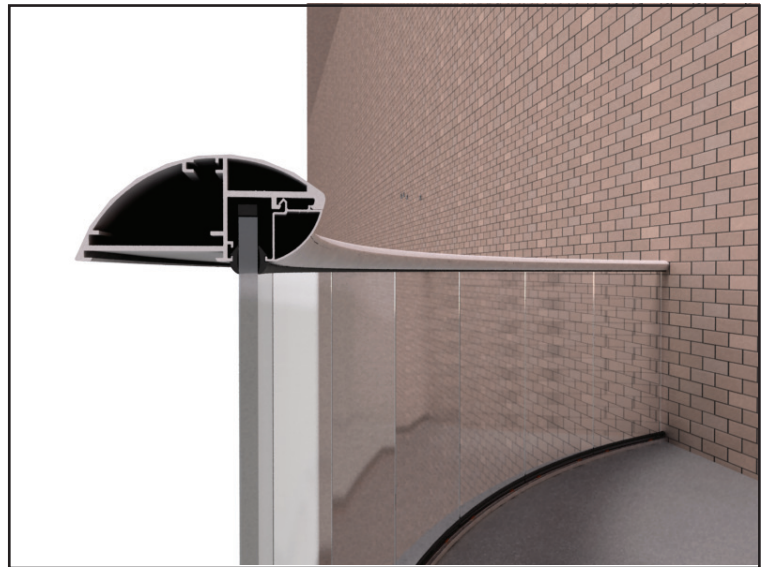

86\* Glaze the top rail using 3mm rubber both sides (not the fixed rubber, but same as internal rubber both sides)

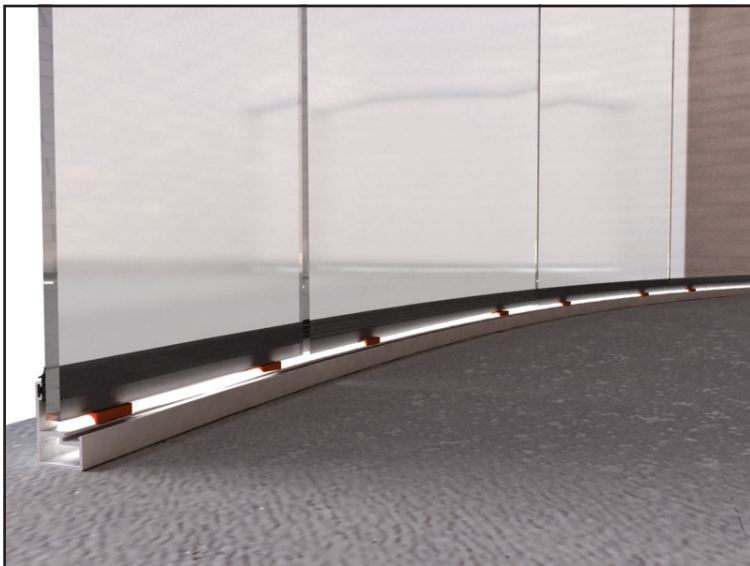

87\* Once the silicone is dry on the bottom rail remove the temporary beads and replace the full length curved bead.

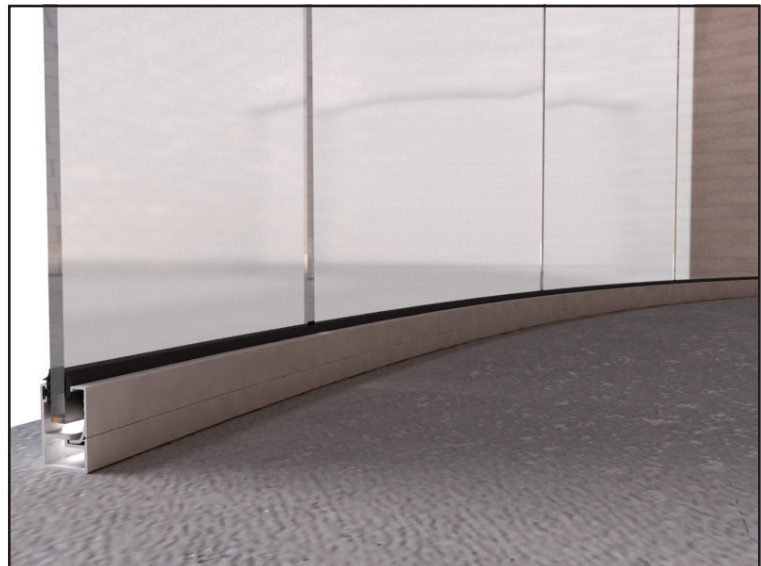

88\* Using the 3mm rubber glaze the bottom rail bead against the glass

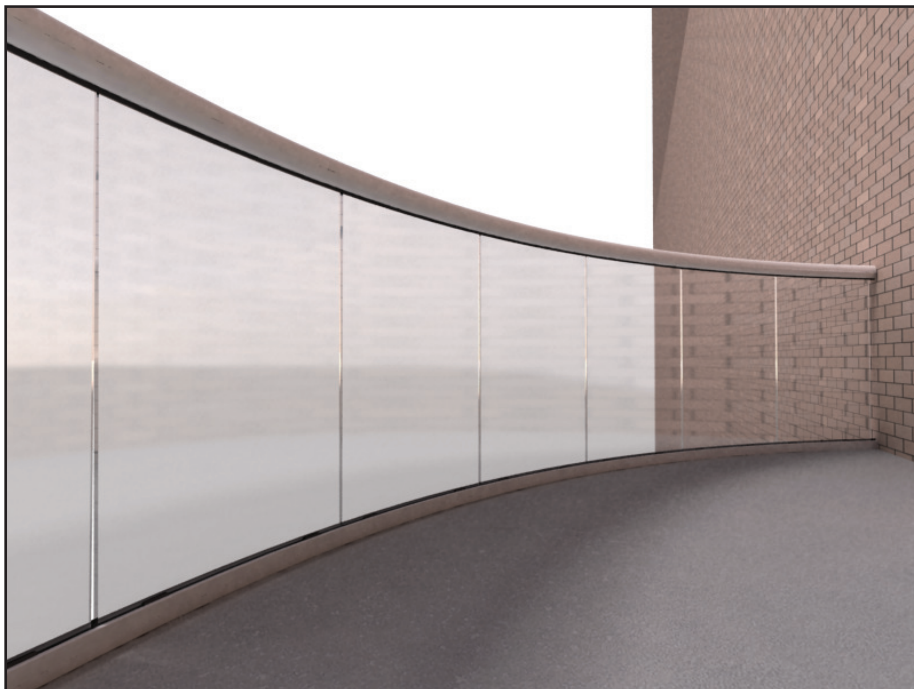





# BALCONY

©Balcony Systems 2011  
[www.balconette.co.uk](http://www.balconette.co.uk)

Tel: +44 1342 410411

Fax: +44 1342 410412

Unit 6, Systems House, Eastbourne Road,  
Blindley Heath, Lingfield, Surrey, RH7 6JP,  
United Kingdom