

MOULDINGS



COVERS

Timber & Builders Merchants

www.covers.biz

Welcome to the Covers Mouldings brochure

If you have any queries, please do not hesitate to contact our staff who will be willing to help you with sound, practical advice.

Please refer to the back page for all depot contact details.

Page 3	Why Choose Covers
Page 4	Our Environmental Policy
Page 5	Profiling Service
Page 6	Chamfered Cills
Page 7	Fascias
Page 8	Matchings
Page 9	TGV & TGVB
Page 10	Architraves
Page 11	Architraves & Handrails
Page 12	Architraves & Dado Rails
Page 13	Sash Materials
Page 14	Window Board & Beading
Page 15	Beading
Page 16	Skirtings
Page 17	Skirtings
Page 18	Softwood T&G Flooring
Page 19	Skirtings & Cornice
Page 20	Shiplaps
Page 21	Shiplaps & Storm Boards
Page 22	Cladding
Page 24	Decking
Page 26	MDF Mouldings - Primed
Page 27	Burbidge Mouldings
Page 35	Useful Conversions
Page 36	Products & Services
Page 37	Other Products
Page 38	Showrooms
Page 39	Other Brochures

In our product descriptions we use the following abbreviation:

Nom = Timber size before machining

Fin = Finished size after machining.

We reserve the right to alter profiles and specifications without notice.

Please note that the colours represented for Cedar and Hardwoods are purely for identification purpose only and not to be used as an accurate likeness.

Why choose Covers

Covers vision is to be our customers' preferred supplier of timber, building and allied materials...

We aim to achieve this in various ways...

- By building lasting partnerships with you, our customer - meeting your requirements promptly, courteously, efficiently and professionally.
- By ensuring that the quality of our service and products give us a leading edge in the market.
- By maintaining a competitive advantage, embracing leading production and operational methods and investing in constructive change.
- By supplying a wide range of quality goods, either from our own stocks or direct from suppliers, at competitive prices.
- By providing technical advice on all products we supply.
- By creating an environment where everyone feels valued and experiences job satisfaction through teamwork and continuing individual development.
- By recruiting and retaining the highest quality staff as an equal opportunities provider.



The mark of responsible forestry



To obtain an estimate or to place an order there are four easy options:

1. Visit your local depot.
2. Telephone your local depot.
3. Fax your request or order to your local depot.
4. Email your local depot with your request or order.



Please note we accept: Mastercard, Maestro, Visa Credit and Visa Debit. Depots details and account information are on the reverse of this brochure.



Our Environmental Policy

- Seek to prevent pollution
- Seek to minimise waste
- Identify and manage environmental risk and hazards
- Identify and influence the choice of construction materials and working methods
- Plan best practice working
- Make better use of the working environment
- Make better and efficient use of resources
- Set environmental standards
- Promote and provide environmental training
- Encourage pro-active participation in environmental activities
- Avoid material waste, water waste, energy waste, vehicle waste, labour waste
- The company is committed to an environmental policy and seeks continuous improvement in performance
- In our organisation there is a continuous learning curve
- We are FSC® and PEFC certified and purchase the majority of our timber from approved managed certified forests



Specialist machinery - Skilled craftsmen

Our milling facilities in Chichester can produce specialist, planed sections and mouldings in hardwood and softwood, to your own pattern and finished sizes.

Regardless of the dimensions and shape, our experienced craftsmen, with a cumulative experience of over 100 years, have the skill to do the job using specialist machinery.

We machine from architects' or customers' own drawings.

In addition to producing over 200 different types of prepared mouldings and planed sections for our own stocks, our modern mills produce specialised products to satisfy customers' specific requirements to order. Our modern technology and machinery allows us to process any size of order easily and quickly.

Production is an all in-house affair.

COVERS controls the job throughout. From the preparation of drawings, to templates, to the making of the high speed steel cutters, the setting up of the machines and to the production itself. It's all done by us.

We have produced scores of special mouldings, including Georgian and Victorian for many famous buildings from Arundel and Windsor Castle to Petworth House. All have required special patterns of skirting, architraves, picture rails, dado rails and very ornate plate rails.

COVERS commitment, in tune with the environment.

COVERS is committed to an Environmental Timber Purchasing Policy & Code of Conduct. We are members of FSC® and PEFC. This means that we source and buy our timber products from sustainable and well managed forests.



The moulding machine at Quarry Lane being set up for a production run. Inset shows examples of typical cutting heads.



Chamfered Cills

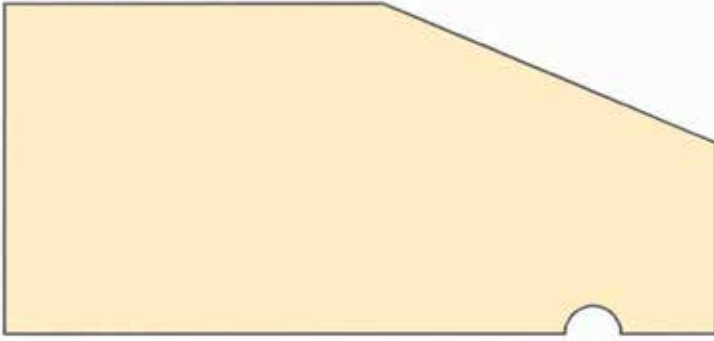

Chamfered Cill

Softwood or Hardwood

Nom. Size : 50mm x 100mm

Fin. Sized : 44mm x 94mm



Chamfered Cill

Softwood or Hardwood

Nom. Size : 50mm x 150mm

Fin. Sized : 44mm x 144mm

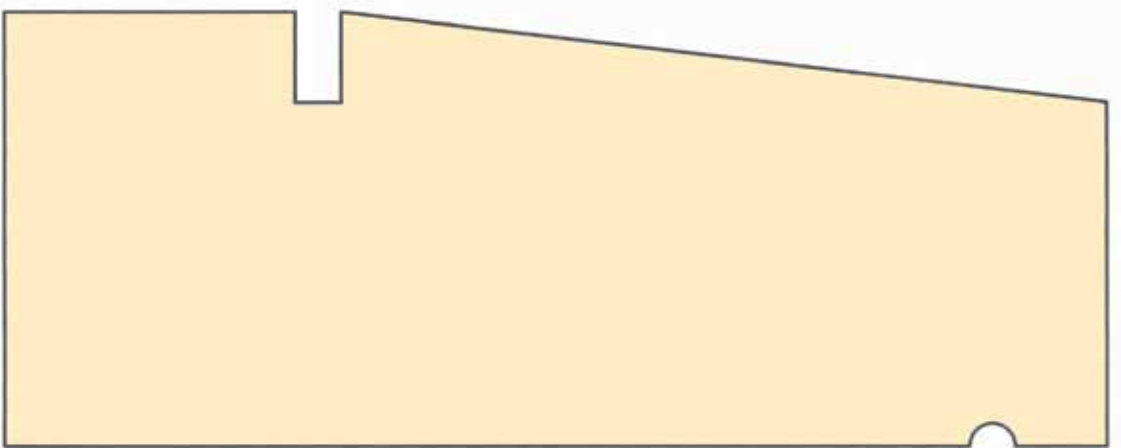

Chamfered Cill (Available to order)

Softwood or Hardwood

Nom. Size : 63mm x 150mm

Fin. Sized : 57mm x 144mm

Grooved Fascia

Softwood

Nom. Size : 25mm x 225mm

Fin. Sized : 21mm x 219mm

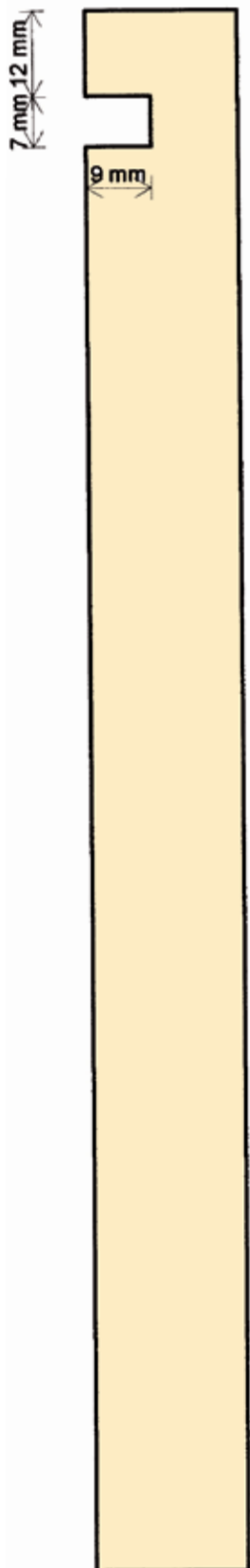

Grooved Fascia

Softwood

Nom. Size : 25mm x 200mm

Fin. Sized : 21mm x 194mm

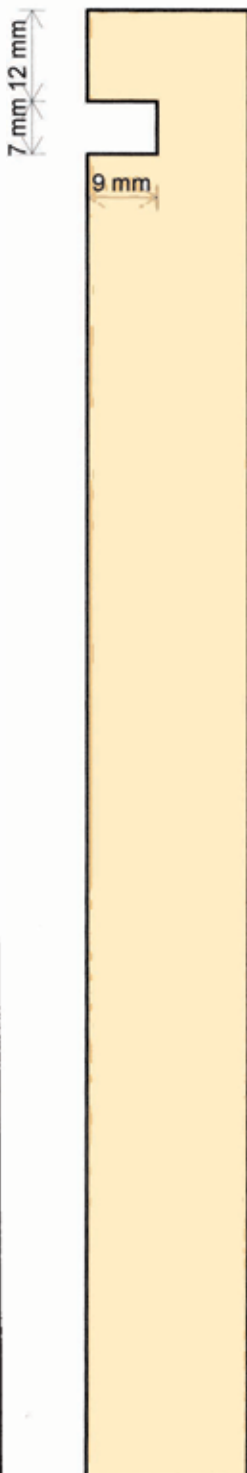

Grooved Fascia

Softwood

Nom. Size : 25mm x 175mm

Fin. Sized : 21mm x 169mm

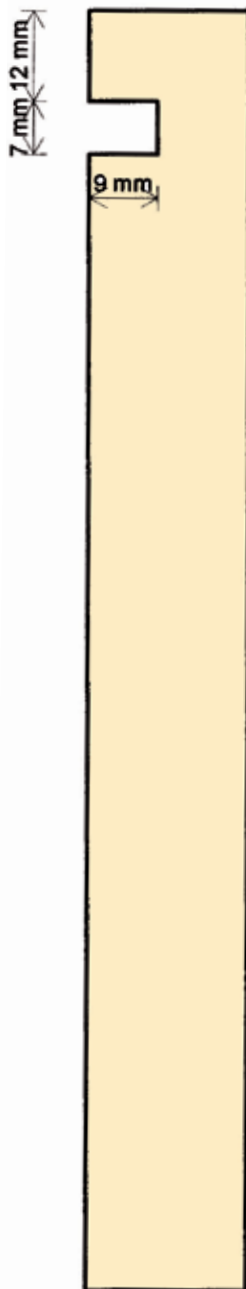

Grooved Fascia

Softwood

Nom. Size : 25mm x 150mm

Fin. Sized : 21mm x 144mm

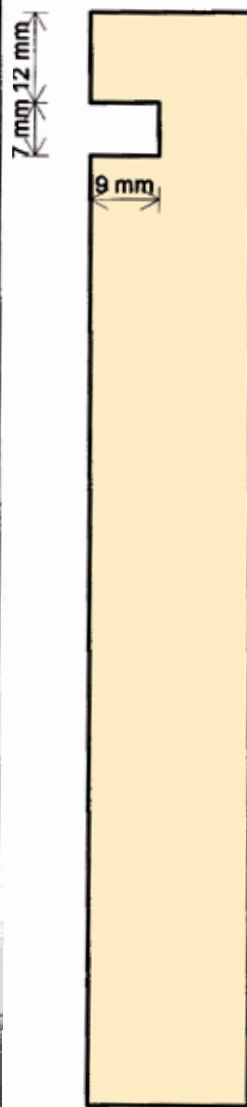

Matchings



TGV

Softwood

Nom. Size : 16mm x 100mm

Fin. Sized : 12mm x 94mm



TGV

Cedar

Nom. Size : 16mm x 100mm

Fin. Sized : 12mm x 94mm



TGV

Softwood

Nom. Size : 19mm x 100mm

Fin. Sized : 15mm x 94mm



TGV B

Softwood (Portsmouth stock only)

Nom. Size : 19mm x 100mm (19mm x 125mm also available)

Fin. Sized : 15mm x 94mm (15mm x 118mm also available)



TGV

Cedar

Nom. Size : 25mm x 100mm

Fin. Sized : 19mm x 94mm

(non stock item)

Nom. Size : 25mm x 150mm

Fin. Sized : 19mm x 144mm



TGV

Softwood

Nom. Size : 25mm x 100mm

Fin. Sized : 21mm x 94mm





TGV

Softwood

Nom. Size : 19mm x 150mm

Fin. Sized : 15mm x 144mm



TGVB

Softwood

Nom. Size : 19mm x 150mm

Fin. Sized : 15mm x 144mm



TGVB

Softwood

Nom. Size : 25mm x 150mm

Fin. Sized : 21mm x 144mm

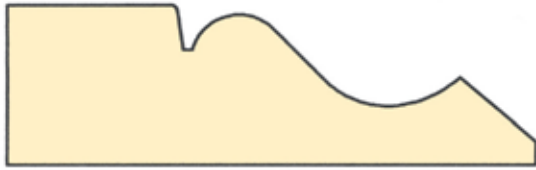

OGEE A11

Softwood

Nom. Size : 25mm x 75mm

Fin. Sized : 21mm x 69mm



PENCIL ROUND 6MM RADIUS

Softwood

Nom. Size : 25mm x 50mm

Fin. Sized : 21mm x 44mm

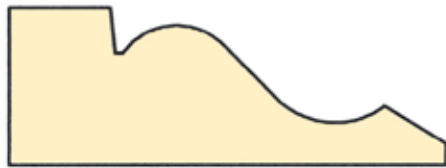

OGEE A13

Softwood

Nom. Size : 25mm x 63mm

Fin. Sized : 21mm x 57mm

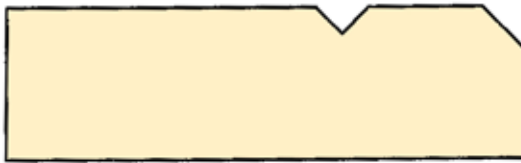

V GROOVED & CHAMFERED

Nom Size : 25mm x 75mm

Fin. Sized : 21mm x 69mm



OGEE A14

Softwood

Nom. Size : 19mm x 50mm

Fin. Sized : 15mm x 44mm

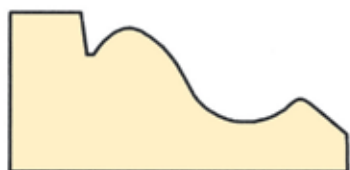

OGEE A15

Softwood

Nom. Size : 25mm x 50mm

Fin. Sized : 21mm x 44mm

Architraves & Handrails



C/R ARCHITRAVE

Softwood

Nom. Size : 19mm x 50mm

Fin. Sized : 15mm x 44mm



B/N ARCHITRAVE

Softwood

Nom. Size : 19mm x 50mm

Fin. Sized : 15mm x 44mm



C/R ARCHITRAVE

Softwood

Nom. Size : 19mm x 63mm

Fin. Sized : 15mm x 57mm



B/N ARCHITRAVE

Softwood

Nom. Size : 19mm x 63mm

Fin. Sized : 15mm x 57mm



C/R

Softwood

Nom. Size : 19mm x 75mm

Fin. Sized : 15mm x 69mm



B/N

Softwood

Nom. Size : 19mm x 75mm

Fin. Sized : 15mm x 69mm

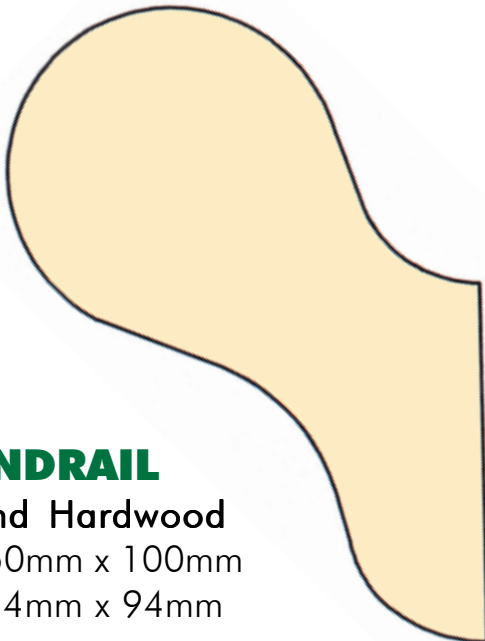

WALL HANDRAIL

Softwood and Hardwood

Nom. Size : 50mm x 100mm

Fin. Sized : 44mm x 94mm

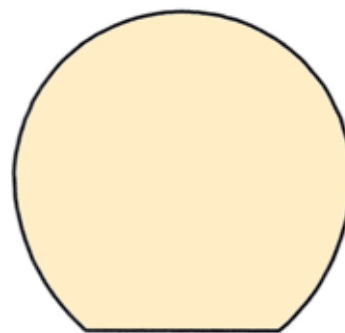

MOPSTICK HANDRAIL

Softwood and Hardwood

Nom. Size : 50mm x 50mm

Fin. Sized : 42mm x 44mm

Architraves & Dado Rails

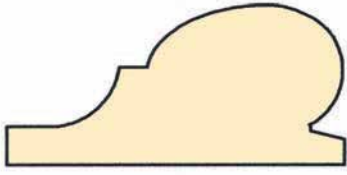

PICTURE RAIL

Softwood

Nom. Size : 25mm x 50mm

Fin. Sized : 21mm x 44mm

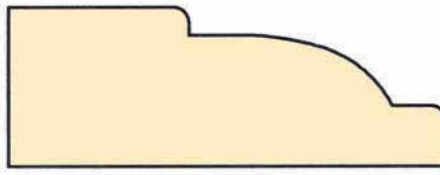

OVOLO

Softwood

Nom. Size : 25mm x 63mm

Fin. Sized : 21mm x 57mm

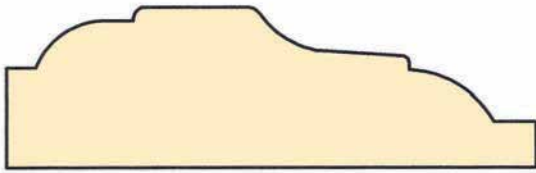

DADO RAIL

Softwood

Nom. Size : 25mm x 75mm

Fin. Sized : 21mm x 69mm

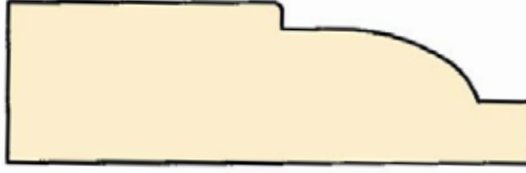

OVOLO

Softwood

Nom. Size : 25mm x 75mm

Fin. Sized : 21mm x 69mm

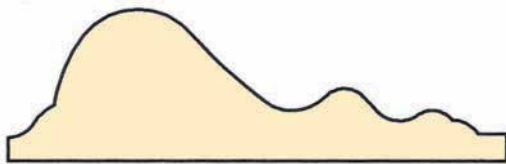

PORTSMOUTH DADO

Softwood

Nom. Size : 25mm x 75mm

Fin. Sized : 20mm x 67mm



HILLREED OVOLO

Softwood

Nom. Size : 25mm x 75mm

Fin. Sized : 21mm x 69mm

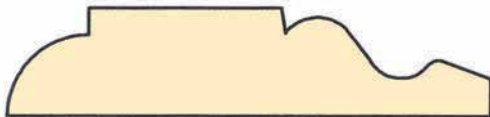

J.M. DADO

Softwood

Nom. Size : 19mm x 75mm

Fin. Sized : 15mm x 67mm

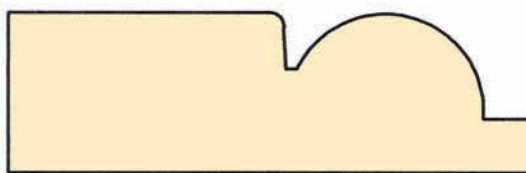

TORUS

Softwood

Nom. Size : 25mm x 75mm

Fin. Sized : 21mm x 69mm

Sash Materials

All of the below items are **"Made to order only"**

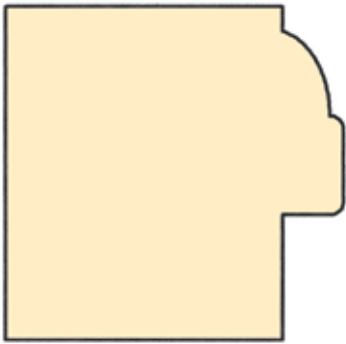

SASH STILE

Softwood

Nom. Size : 50mm x 50mm

Fin. Sized : 44mm x 44mm

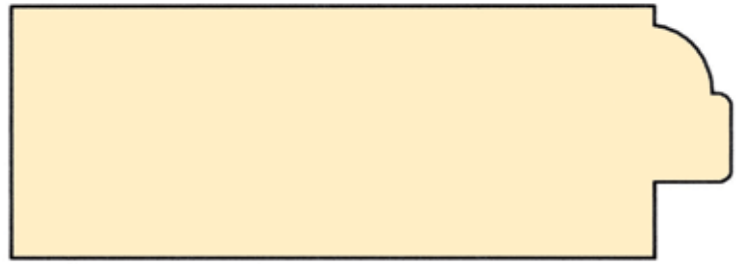

BOTTOM RAIL

Softwood

Nom. Size : 38mm x 100mm

Fin. Sized : 33mm x 94mm



BOTTOM RAIL

Softwood

Nom. Size : 50mm x 100mm

Fin. Sized : 44mm x 94mm

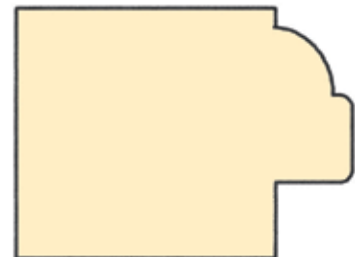

SASH STILE

Softwood

Nom. Size : 38mm x 50mm

Fin. Sized : 33mm x 44mm

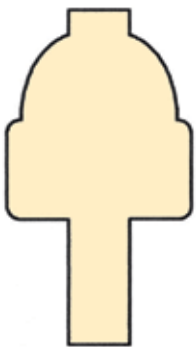

SASH BAR

Softwood

Nom. Size : 32mm x 50mm

Fin. Sized : 24mm x 44mm

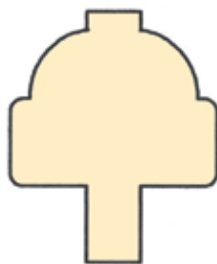

SASH BAR

Softwood

Nom. Size : 32mm x 38mm

Fin. Sized : 27mm x 33mm

Window Board & Beading

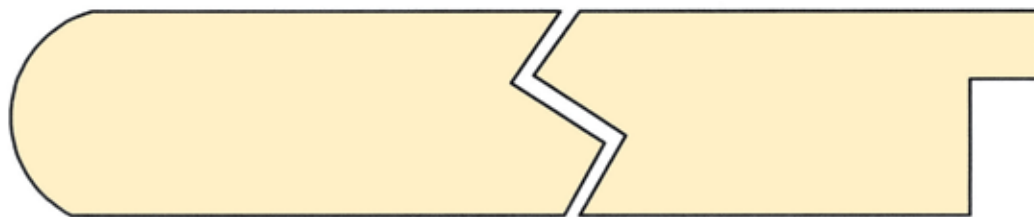

32mm WINDOWBOARD

Softwood

Nom. Size : 32mm x 75mm Fin. Size : 27mm x 69mm

Nom. Size : 32mm x 150mm Fin. Size : 27mm x 144mm

Nom. Size : 32mm x 225mm Fin. Size : 27mm x 219mm

Laminated Windowboard

Nom. Size : 32mm x 300mm Fin. Sized : 25mm x 285mm

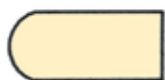

PARTING BEAD

Softwood

Nom. Size : 13mm x 25mm

Fin. Sized : 9mm x 20mm



CHAMFERED BEAD

Softwood

Nom. Size : 13mm x 25mm

Fin. Sized : 9mm x 21mm



HALF ROUND

Softwood

Nom. Size : 12.5mm x 25mm

Fin. Sized : 9mm x 20mm



QUADRANT

Softwood

Nom. Size : 12.5mm x 12.5mm

Fin. Sized : 9mm x 9mm



QUADRANT

Softwood

Nom. Size : 19mm x 19mm

Fin. Sized : 15mm x 15mm



QUADRANT

Softwood

Nom. Size : 25mm x 25mm

Fin. Sized : 21mm x 21mm



SCOTIA

Softwood

Nom. Size : 25mm x 25mm

Fin. Sized : 21mm x 21mm

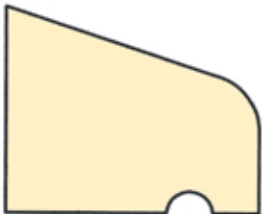

HEAD DRIP

Softwood

Nom. Size : 32mm x 38mm

Fin. Sized : 27mm x 33mm

Available at Bognor only



S.P. PANEL MOULD

Softwood

Nom. Size : 19mm x 50mm

Fin. Sized : 12mm x 37mm



STAFF BEAD

Softwood

Nom. Size : 19mm x 25mm

Fin. Sized : 15mm x 21mm



HARDWOOD GLAZING BEAD

Hardwood

Nom. Size : 25mm x 32mm

Fin. Sized : 21mm x 25mm



OGEE PANEL MOULD

Softwood

Nom. Size : 19mm x 25mm

Fin. Sized : 10mm x 21mm

Available at Bognor only



TORUS-OGEE

Softwood

Nom. Size : 25mm x 225mm

Fin. Sized : 21mm x 218mm



TORUS-OGEE

Softwood

Nom. Size : 25mm x 175mm

Fin. Sized : 21mm x 169mm



TORUS-OGEE

Softwood

Nom. Size : 25mm x 150mm

Fin. Sized : 21mm x 144mm



TORUS-OGEE

Softwood

Nom. Size : 25mm x 125mm

Fin. Sized : 21mm x 118mm



OGEE PENCIL ROUND

Softwood

Nom. Size : 25mm x 100mm

Fin. Sized : 21mm x 94mm

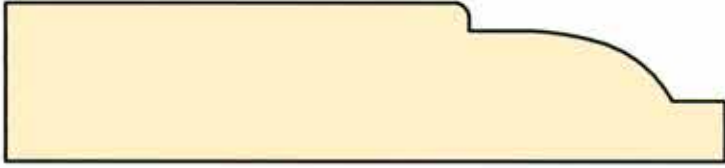

OVOLO

Softwood

Nom. Size : 25mm x 100mm

Fin. Size : 21mm x 94mm



V.GROOVED & CHAMFERED/OVOLO SKIRTING

Softwood

Nom. Size : 25mm x 150mm

Fin. Size : 21mm x 144mm

Nom. Size : 25mm x 175mm

Fin. Size : 21mm x 169mm



HILLREED OVOLO

Softwood

Nom. Size : 25mm x 150mm

Fin. Size : 21mm x 144mm

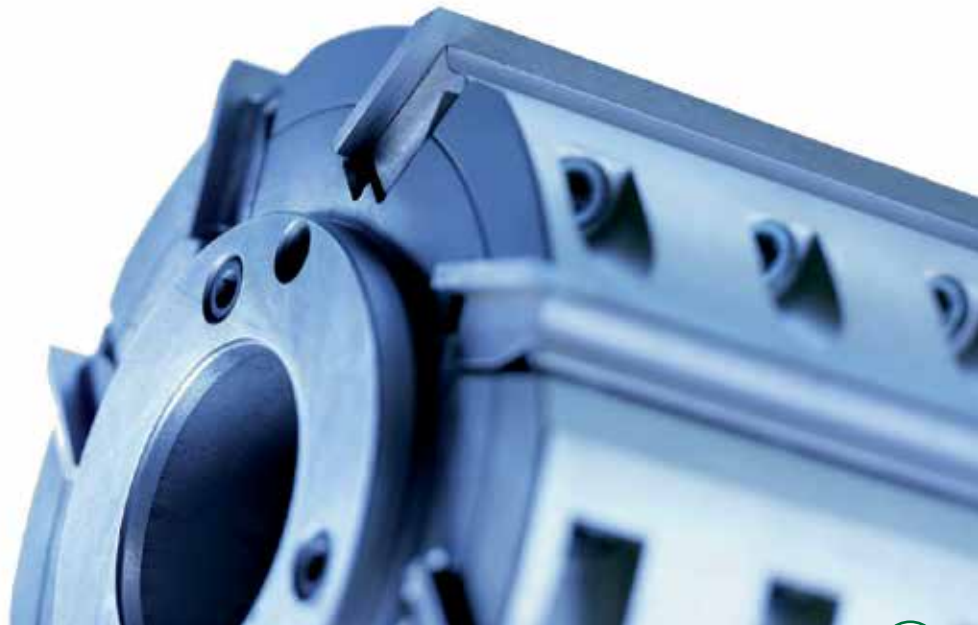

Softwood T&G Flooring



T&G (Available in both contract grade and U/S red)

Softwood

Nom. Size : 25mm x 125mm

Fin. Sized : 21mm x 118mm



T&G (Available in contract grade)

Softwood

Nom. Size : 22mm x 150mm

Fin. Sized : 19mm x 144mm

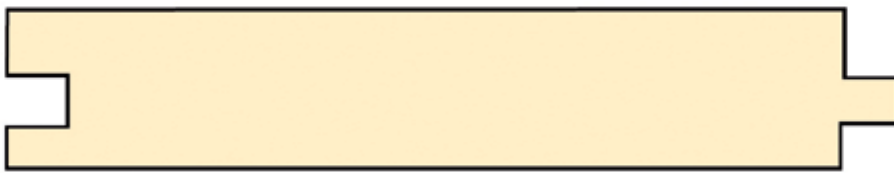

T&G (Available in contract grade)

Softwood

Nom. Size : 22mm x 125mm

Fin. Sized : 19mm x 118mm

Skirtings & Cornice



DUAL PURPOSE SKIRTING

Softwood

Nom. Size : 19mm x 100mm

Fin. Sized : 15mm x 94mm

Nom. Size : 19mm x 150mm

Fin. Sized : 15mm x 144mm

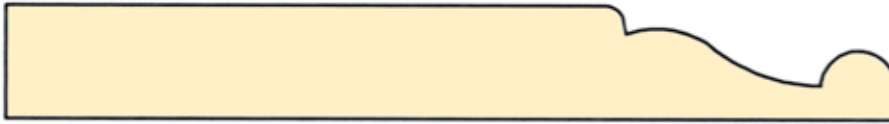

G.G. SKIRTING (Stocked at Bognor, available to order)

Softwood

Nom. Size : 19mm x 125mm

Fin. Sized : 15mm x 118mm



CORNICE

Softwood

Nom. Size : 25mm x 150mm

Fin. Sized : 22mm x 144mm



SHIPLAP

Cedar

Nom. Size : 25mm x 100mm

Fin. Sized : 19mm x 94mm



SHIPLAP

Cedar

Nom. Size : 16mm x 100mm

Fin. Sized : 11mm x 92mm



P.R.C.

Softwood

Nom. Size : 19mm x 150mm

Fin. Sized : 15mm x 144mm



SHIPLAP

Softwood

Nom. Size : 19mm x 125mm

Fin. Sized : 15mm x 119mm



SHIPLAP

Softwood

Nom. Size : 19mm x 150mm

Fin. Sized : 14.5mm x 144mm

Shiplaps & Storms Boards



SHIPLAP

Cedar

Nom. Size : 25mm x 150mm

Fin. Sized : 19mm x 144mm



SHIPLAP

Softwood

Nom. Size : 25mm x 150mm

Fin. Sized : 21mm x 144mm

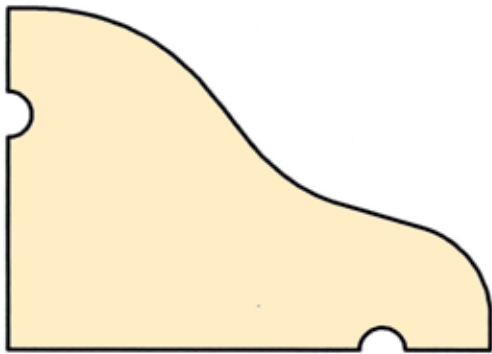

STORMBOARD

Softwood or Hardwood

Nom. Size : 50mm x 75mm

Fin. Sized : 45mm x 66mm

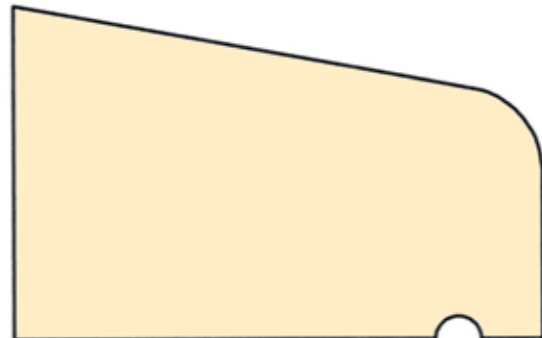

SUB CILL

Softwood

Nom. Size : 50mm x 75mm

Fin. Sized : 44mm x 69mm

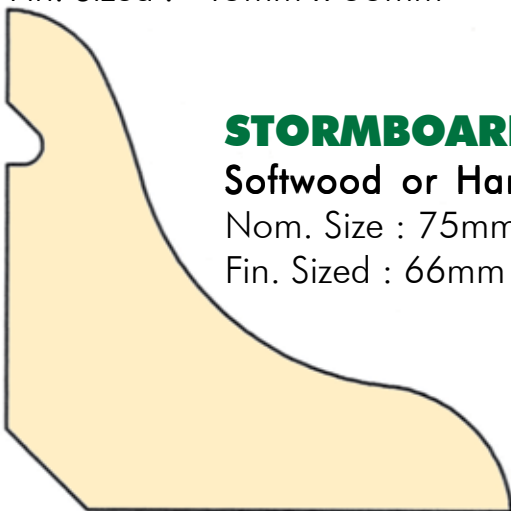

STORMBOARD

Softwood or Hardwood

Nom. Size : 75mm x 75mm

Fin. Sized : 66mm x 66mm

All of the below items are **"Made to order only"**



VT-1

Cedar (non stock item)

Nom. Size : 25mm x 150mm

Fin. Sized : 18mm x 144mm



VT-2

Cedar (non stock item)

Nom. Size : 25mm x 150mm

Fin. Sized : 18mm x 144mm



VT-6

Cedar (non stock item)

Nom. Size : 25mm x 150mm

Fin. Sized : 18mm x 144mm



VT-7

Cedar (non stock item)

Nom. Size : 25mm x 150mm

Fin. Sized : 18mm x 144mm



VT-302

Cedar (non stock item)

Nom. Size : 25mm x 150mm

Fin. Sized : 18mm x 141mm



COVERS RUSTIC CLADDING

Tanalised Carcassing

Nom. Size : 25mm x 150mm

Fin. Sized : 20mm x 142mm

All of the below items are **"Made to order only"**



VT-9

Cedar (non stock item)

Nom. Size : 25mm x 150mm

Fin. Sized : 18mm x 144mm



VT-10

Cedar (non stock item)

Nom. Size : 25mm x 150mm

Fin. Sized : 18mm x 144mm



TGV

Cedar (non stock item)

Nom. Size : 25mm x 150mm

Fin. Sized : 19mm x 137mm (Face cover)



EXT TONGUE TGV (12MM)

Cedar

Nom. Size : 25mm x 150mm

Fin. Sized : 19mm x 132mm (Face cover)



DECKING BASERAIL

Softwood

Nom. Size : 25mm x 75mm

Fin. Sized : 21mm x 69mm

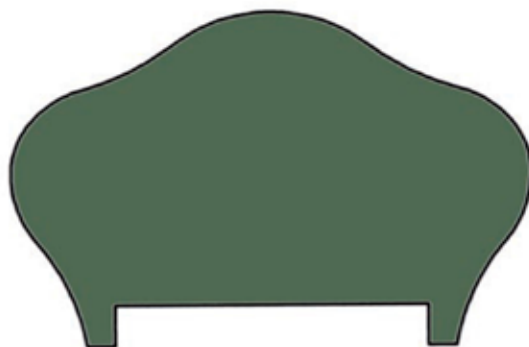

DECKING HANDRAIL

Softwood

Nom. Size : 50mm x 75mm

Fin. Sized : 44mm x 68mm



DECKING

Softwood

Nom. Size : 32mm x 125mm

Fin. Sized : 27mm x 118mm



DECKING

Softwood

Nom. Size : 32mm x 150mm

Fin. Sized : 27mm x 144mm



HARDWOOD DECKING

Hardwood

Nom. Size : 25mm x 100mm

Fin. Sized : 19mm x 90mm



DECKING

Hardwood

Nom. Size : 25mm x 150mm

Fin. Sized : 21mm x 145mm

**Pick up a copy of our
Decking brochure from
any depot**

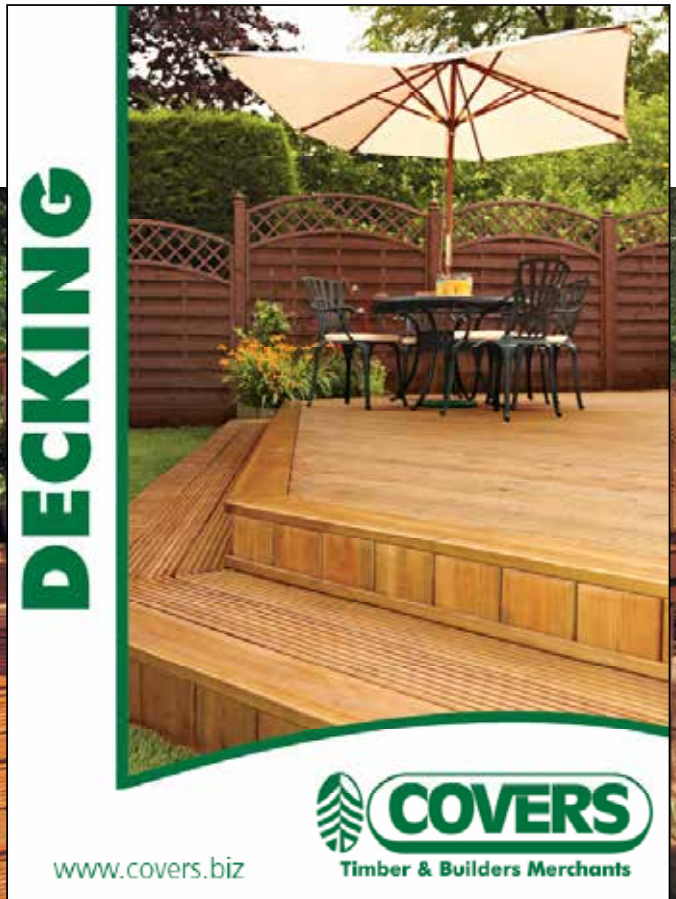
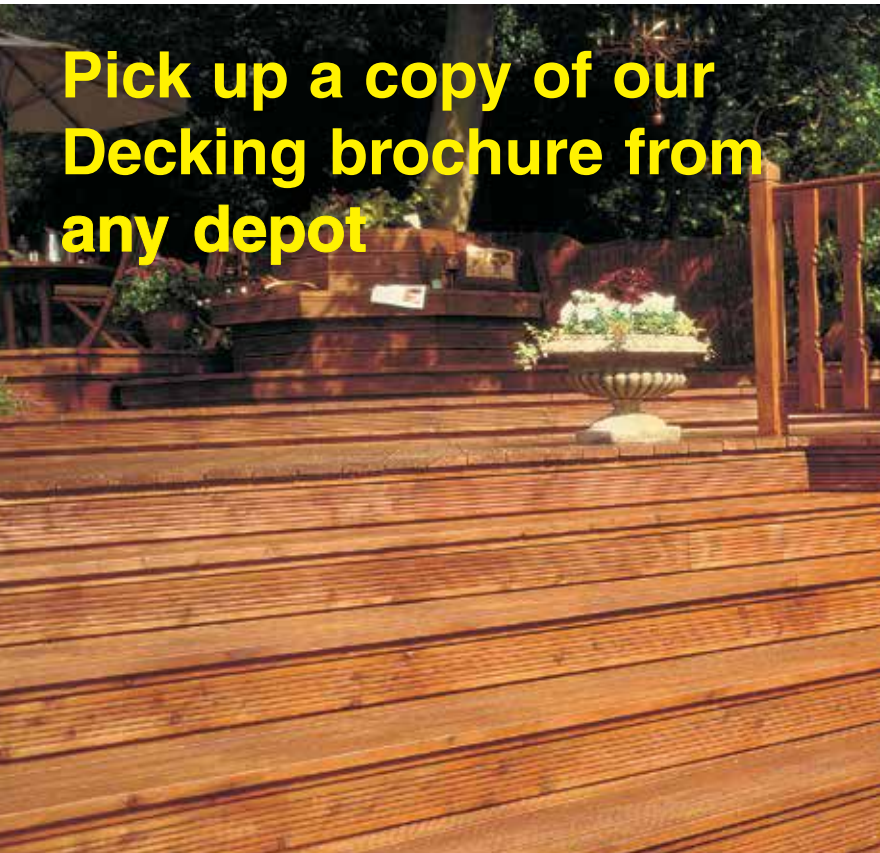

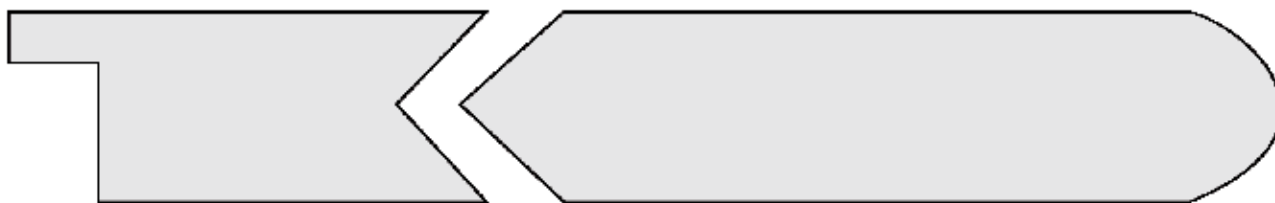

WINDOW BOARD (also available in 5.4 metre lengths, please ask for details)

Fin. Sized : 25mm x 169mm, 25mm x 194mm, 25mm x 219mm, 25mm x 244mm, 25mm x 294mm



TORUS SKIRTING

Fin. Sized : 18mm x 144mm, 18mm x 119mm & 18mm x 68mm



OVOLO ARCHITRAVE

Fin. Sized : 18mm x 68mm
18mm x 144mm



OGEE SKIRTING

Fin. Sized : 18mm x 119mm, 18mm x 144mm,
18mm x 168mm



**CHAMFERED
& ROUNDED SKIRTING**

Fin. Sized : 15mm x 94mm

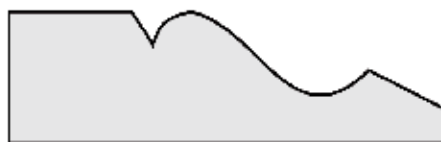

OGEE ARCHITRAVE

Fin. Sized : 18mm x 58mm, 18mm x 68mm



BULL NOSED SKIRTING

Fin. Sized : 15mm x 94mm
18 x 68 6mm Pencil Round
18 x 119 6mm Pencil Round
18 x 119 7mm Chamfer & Round

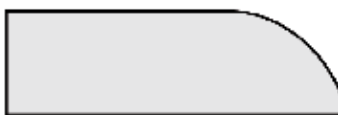

BULL NOSED ARCHITRAVE

Fin. Sized : 15mm x 44mm

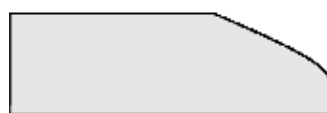

**CHAMFERED &
ROUNDED ARCHITRAVE**

Fin. Sized : 15mm x 44mm

DECORATIVE



DECORATIVE









DECORATIVE



SCOTIA









SCOTIA

	FB077 Angle Hardwood 20x20
	FB078 Angle Hardwood 21x21
	FB083 Angle Dark Hardwood 27x27
	FB084 Angle Hardwood 27x27
	FB085 Angle Pine 34x34
	FB086 Angle Dark Hardwood 34x34
	FB134 Scotia Dark Hardwood 13x13
	FB135 Plain Scotia Hardwood 16x16

SCOTIA

	FB137 Plain Scotia Dark Hardwood 16x16
	FB138 Scotia Pine 16x27
	FB143 Scotia Hardwood 21x32
	FB145 Plain Scotia Hardwood 22x22
	FB146 Plain Scotia Dark Hardwood 22x22
	FB248 Aluminium Angle 12mm
	FB249 Aluminium Angle 18mm
	FB250 Aluminium Angle 25mm

SCOTIA

	FB294 Angle Pine 13x13
	FB295 Birdsmouth Angle Pine 18x18
	FB365 Plain Scotia Pine 22x22
	FB373 Plain Scotia Pine 13x13
	FB377 Wedge Bead Pine 10x13
	FB378 Chamfered Bead Pine 10x19
	FB381 Round Edge Angle Pine 12x33
	FB386 Triangular Bead Pine 20x20

SCOTIA

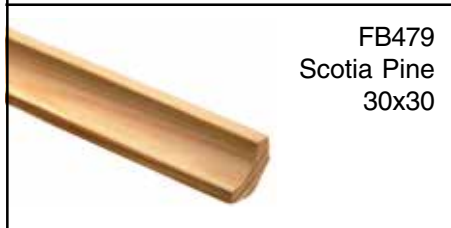
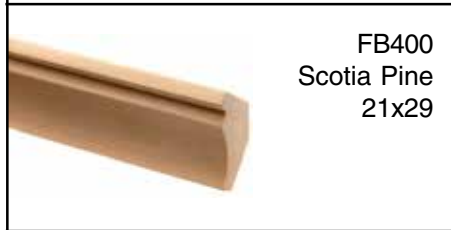
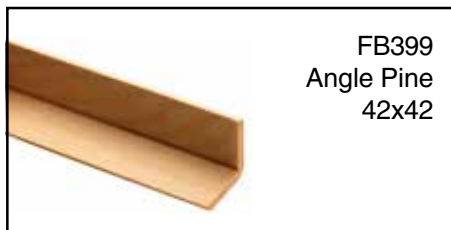

SCOTIA



ASTRAGALS

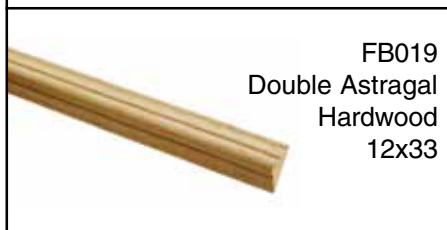
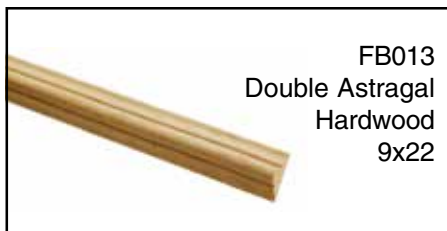



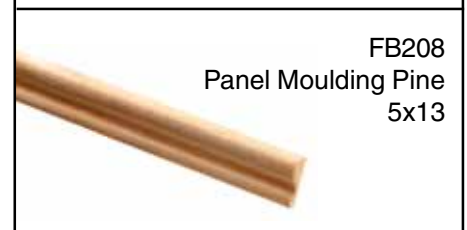





PANEL MOULDINGS











D SHAPE HALF ROUNDS

	FB039 D Shape Dark Hardwood 4x18
	FB040 D Shape Hardwood 4x18
	FB041 D Shape Dark Hardwood 4x22
	FB042 D Shape Hardwood 4x22
	FB046 D Shape Hardwood 4x29
	FB047 Flat D Shape Hardwood 6x22
	FB048 Flat D Shape Hardwood 5x33
	FB049 D Shape Hardwood 6x37

D SHAPE HALF ROUNDS

	FB196 Half Round Hardwood 4x12
	FB197 Half Round Hardwood 6x14
	FB199 Half Round Hardwood 9x22
	FB272 D Shape Oak 21x4
	FB370 Shape Pine 4x22
	FB374 Half Round Pine 6x18
	FB409 D Shape Pine 34x8
	FB410 Flat D Shape Pine 34x8

D SHAPE HALF ROUNDS

	FB442 D Shape Pine 16x4
	FB453 Fluted Half Round Pine 4.5x21
	FB454 Reeded Half Round Pine 5.5x18
	FB455 Reeded Angle Pine 18x18
	FB456 Reeded Angle Pine 27x27
	FB457 Windsor Angle Pine 20mm
	FB458 Windsor Angle Pine 34mm
	FB459 Birdsmouth Angle Pine 27mm

D SHAPE HALF ROUNDS



DOWELL

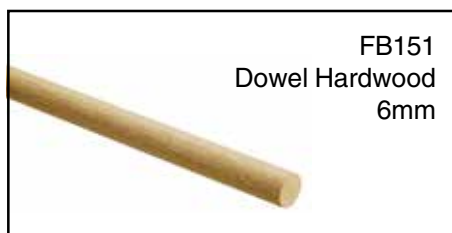

DOWELL

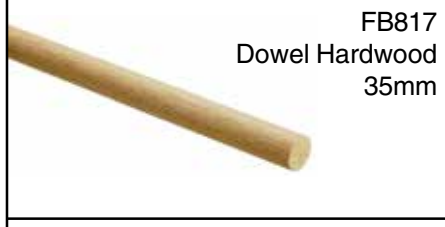

STRIP WOOD

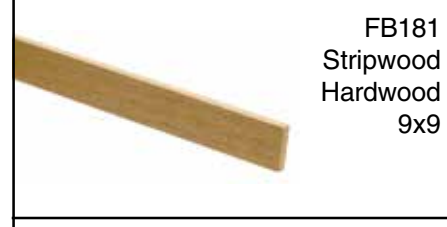

STRIP WOOD

	FB183 Stripwood Pine 7x18
	FB184 Stripwood Hardwood 9x18
	FB185 Stripwood Dark Hardwood 9x18
	FB186 Stripwood Hardwood 9x28
	FB189 Stripwood Pine 12x12
	FB204 Stripwood Hardwood 5x25
	FB206 Stripwood Hardwood 12x25
	FB323 Stripwood Pine 9x36





STRIP WOOD

	FB366 Stripwood Pine 4x18
	FB367 Stripwood Pine 4x28
	FB368 Stripwood Pine 4x36
	FB404 Stripwood Pine 20x20
	FB420 Stripwood Dark Hardwood 44x8
	FB436 Stripwood Pine 25x12
	FB467 Rounded Stripwood Pine 15x36
	FB468 Rounded Stripwood Pine 21x44

STRIP WOOD

	FB483 Stripwood Pine 12x21
---	----------------------------------

QUADRANT

	FB111 Quadrant Dark Hardwood 7x7
	FB116 Quadrant Dark Hardwood 11x11
	FB119 Quadrant Dark Hardwood 13x13
	FB124 Hardwood 16x16
	FB125 Quadrant Dark Hardwood 16x16

QUADRANT

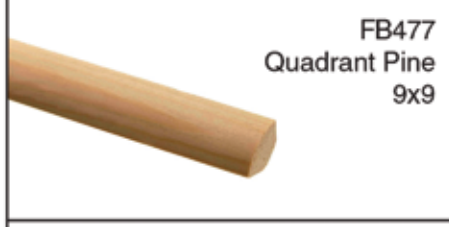
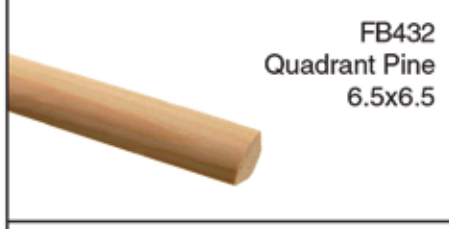
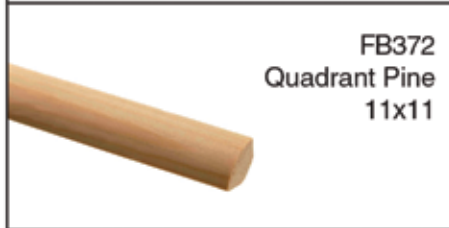
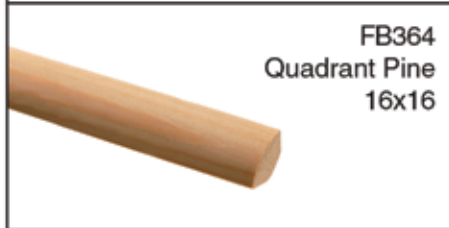
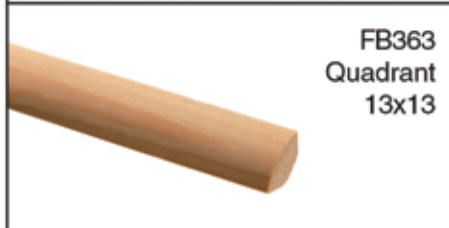

QUADRANT



PAR



QUADRANT



PICTURE FRAME

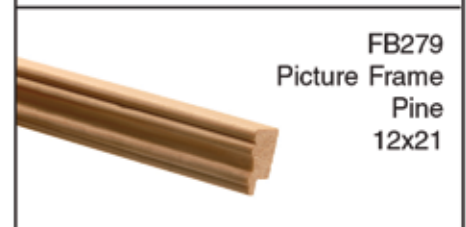
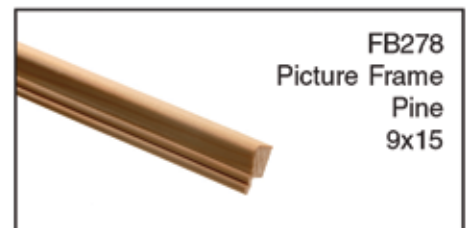

GLASS BEAD



HOCKEY STICK

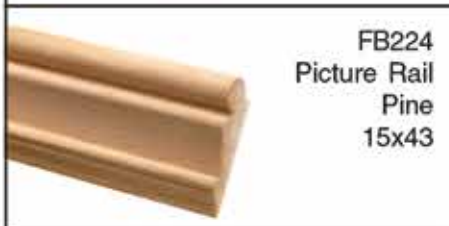

OGEE



**FOR THE FULL RANGE
OF BURBIDGE
MOULDINGS, PLEASE
SEE MEMBER OF STAFF**



OGEE



Images supplied by Richard Burbidge

Useful Conversions

All sizes are nominal in width and thickness

CONVERSION TABLE	
Metric Lengths (as imported)	Equivalent Imperial Length
1.2	3'11 1/4"
1.5	4'11"
1.8	5'10 7/8"
2.1	6'10 5/8"
2.4	7'10 1/2"
2.7	8'10 1/4"
3.0	9'10 1/8"
3.3	10'9 7/8"
3.6	11'9 3/4"
3.9	12'9 1/2"
4.2	13'9 3/8"
4.5	14'9 1/8"
4.8	15'9"
5.1	16'8 3/4"
5.4	17'8 5/8"
5.7	18'8 3/8"
6.0	19'8 1/4"
6.3	20'8"
6.6	21'7 7/8"
6.9	22'7 5/8"
7.2	23'7 1/2"

RUNNING METRES PER SQUARE FOOT (100sq.ft.)
4" wide (100mm) = 91.5 metres (300')
4.5" wide (115mm) = 81.5 metres (267')
5" wide (125mm) = 73.2 metres (240')
5.5" wide (138mm) = 66.5 metres (248')
6" wide (150mm) = 61.0 metres (200')

RUNNING METRES PER SQUARE METRE (m ²)
75mm wide = 13.33m
100mm wide = 10.00m
115mm wide = 8.70m
125mm wide = 8.00m
138mm wide = 7.14m
150mm wide = 6.70m
175mm wide = 5.71m
200mm wide = 5.00m
225mm wide = 4.44m

For laid measure you should
allow an extra 10%
(ie. for the width of the Tongue & Groove)

8' x 4' sheet = 2.98 sq. metres
10' x 5' sheet = 4.66 sq. metres

METRIC CONVERSION	
Foot Run	Metres Run
1	0.305
5	1.525
10	3.050
15	4.575
20	6.100
25	7.625
30	9.150
40	12.200
50	15.250
100	30.500
200	61.00
500	152.500
1000	305.000
1500	457.000
2000	610.000

12.5mm	1/2"
16mm	5/8"
19mm	3/4"
25mm	1"
32mm	1 1/4"
38mm	1 1/2"
50mm	2"
75mm	3"

4.672 cu.mtr is equivalent
to 1 standard

MORE USEFUL CONVERSIONS

- 1 inch = 25.4 millimetres (mm)
- 1 foot = 30.38 centimetres (cm)
- 1 yard = 0.9144 metres (m)
- 1 standard = 165 cu.ft. = 4.672 cu.mtr

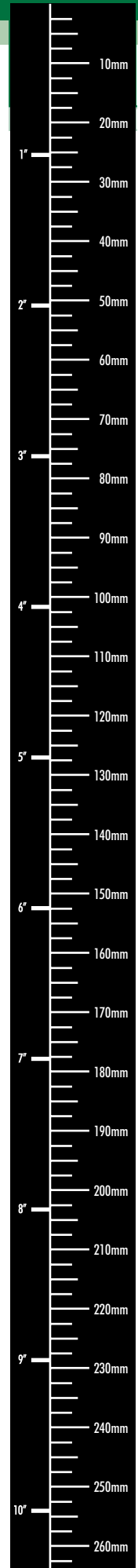

Products and Services

Why not visit your local Covers Depot. With over 23,000 products stocked at our branches you will find everything you need, whether you are doing DIY, Decorating, or Building a House or Commercial Property from scratch!

Products Timber

Blockboard	Glulam Beams	Roof Packages
Bolted and Connected Trusses	Hardboard	Roof Trusses
Bulk Timber up to 12m long	Hardwoods	Scaffold Boards
Carcassing up to 7.8m lengths	Insulation Boards	Sheet Materials
Cedar Shingles, Cedar Shiplap, Cedar TGV	Joinery Softwoods	Sleepers
Chipboard	Marine Grade Plywood Two Grades	Stairs
Decking - Softwood and Hardwood	MDF Sheets and Mouldings	Timber Frame Structures
Doors - Interior and Exterior fire doors	Plasterboards	Trussed Rafters
Dry Stress Graded Timber	Plaster Laths 4mm x 25mm	Truss Joist 'I' Beams
Fencing Materials	Plywoods	Veneered Plywoods
Flag Poles	Prepared and Moulded Timber	Windows ~ Timber and UPVC
Floor Cassettes	Primed Prepared Timber Facilities	and much more...
Frames and Linings (All sizes)	Protim Preservative Treatments	

Products Building

Adhesives and Sealants	Electrical Fittings	Polycarbonate Roofing
Aggregates	Felts and Damp Course	Plasterboards
Bathrooms and Accessories	Fencing	Plumbing Accessories
Biomass	Fixtures	Protective Clothing
Brassware	Garage Doors	Radiators
Bricks and Blocks	Garden Supplies	Rainwater Harvesting
Builders Fixings	Ground Source Heat Pumps	Rainwater and Soil Systems
Calor Gas	Heating Controls	Roof Slates and Tiles
Cement	Housewares	Sanitaryware
Circulating Pumps	Immersion Heaters	Shelving Systems
Claddings	Insulation Products	Showers
Concrete Mixers	Ironmongery	Solar Panels
Concrete Products	Joist Hangers and Straps	Sun tubes/tunnels
Copper Cylinders	Kitchens and Accessories	Tanks and Laggings
Copper Tube	Ladders and Steps	Thermafleece
Curtain Tracks	Lead	Tools - Hand and Power
Damproofing Products	Lintels	Underfloor heating
De-humidifiers	Manhole Covers and Frames	Waste and Overflow
Decking Nails, Screws and Accessories	Melamine Board	Woodcare Products
Decorators Products	Nails, Screws and Bolts	and much more...
Door Furniture	Paints, Varnishes and Preservatives	
Drainage	Paving Slabs	

Services

Brick Matching	Paint Mixing	Special Machining service
Contract Kitchens and Bathrooms	Priming and Service	Strength Grading
Delivery	Sawn and Prepared Timbers	Tanalith Preservative Treatments
Eco Expertise	Sawmilling and Machining Facilities	Timber Moulding
Kitchen and Bathroom Design Service	Sheet Cutting	Timber Treatments
Landscaping Design Service	Special Order Service	and much more...
Milling Service	Specialist Products	

Other Products

Timber

Our reputation as the South of England's Timber Specialists has been built on providing our customers with an unrivalled range of quality timber, knowledgeable staff and a reliable delivery service. We import timber direct from well managed and sustainable forests and offer FSC® and PEFC certified goods wherever possible. Our investment in special milling technology allows us to make the claim..... "If you can draw it, we can produce it". We can provide priming, sheet and aperture door cutting; stress grading and timber treatment systems to ensure our timber will meet your specification. We can also treat timber for both internal and external applications.



Softwood Range

Kiln dried and graded carcassing • Preservative treatment • CLS studding • Treated battens • Scaffold boards
Cedar shingles Shiplap and TGV • PAR and mouldings • Top grade sawn Redwood • Decking • Flooring

Hardwood Range

European Oak • Tulipwood • Iroko and Utile • Sapele and Meranti • American White Oak and Ash • American Cherry
White Beech • Steamed Beech • Idigbo • American Black Walnut



Heavy Building Materials

Building on our experience as a leading independent supplier of heavy and related building materials, we have a great understanding of both trade and retail needs. Our knowledgeable staff can source almost any item for you and give advice on the most suitable products to use. We offer a consistently reliable delivery service from stock and provide a direct sales service. Our quotation departments provide a fast response for enquiries for direct to site loads and ex-depot trade. Aggregates are available either loose, bagged or in non-returnable bulk bags. Our major Depots hold a wide range of bricks relevant to local requirements. All depots hold stocks of cement, plasters, plasterboard, insulation and drainage and at Chichester specialist stocks are held of new and second hand clay and cement roof tiles.

Delivery vehicles are equipped with mechanical handling equipment to ensure fast and efficient off loading at your site.

Hardware and Decorating

Our vast range of lightside products is forever growing! We are constantly seeking new products, ranges and areas which we see as beneficial to our customers. Our skilled sales office staff are equipped with product libraries to assist the sourcing of special and unusual orders.

All of our depots are staffed by experienced individuals who all have specialist knowledge of the products we sell.





Landscaping

Covers stock an extensive range of exciting landscaping materials from the leading manufacturers. Our inspirational selection of natural stone, concrete paving, block paving, decorative aggregates, decking, fencing and garden buildings will ensure you find the perfect products to help you transform your garden or driveway. Covers landscape centres all boast a diverse range of products on display to assist you with your selection and knowledgeable staff who can calculate the quantities you require for your project.



Flooring

Nothing beats the feel of good flooring under foot, whether it's solid, engineered or laminate. Practical, hardwearing and requiring minimal maintenance, the best solid flooring has remarkable resilience to the knocks and bumps of everyday life – and can last for decades. At Covers, we're able to offer over 20 different types of timber and timber-style floor coverings from major manufacturers and importers, with knowledge and installation advice to match.



Kitchens and Bathrooms

Our dedicated kitchen and bathroom showrooms at Chichester, Bognor Regis and Portsmouth offer an array of traditional and contemporary designs to accommodate all tastes and budgets. Covers experienced staff will help you through the decision making process and will provide you with a free design and quotation.



Trade Kitchens and Bathrooms

At Covers, we never forget that kitchens and bathrooms sell houses. That's why we offer a vast selection of kitchens, bathrooms, appliances and accessories to reflect all the very latest design trends. With ranges from leading suppliers such as Sheraton, Symphony and Ideal Standard, we have everything you need. We will seamlessly guide you through the process of selecting a new kitchen or bathroom for your latest development, conversion or extension. Consultation, design, quotation, delivery. We've got it all under one roof – with a patient and responsive attitude to service.



Doors, Windows and Conservatories

We're the areas largest stockist of quality doors and windows with dedicated showrooms in Chichester, Bognor Regis and Lewes. We stock high technology doors and windows from world class suppliers like Premdor, Jeld-Wen, Vicaima, Johnson Aldridge and many more. Covers are a proud member of the British Woodworking Federation, which is responsible for the quality control and development of doors and windows in the UK.

Covers also supply an excellent range of made to measure UPVC products, such as doors, windows and conservatories. Fibreglass doorsets are also available in various colours and styles.



Eco Centre

Covers has put green issues to the top of our agenda and opened the South East's first ever Eco Centre.

Customers can now view the very latest eco building products and appliances under one roof. The Eco Centre is a vital resource for consumers to learn about how to make their home energy efficient and eco friendly.

- Working solar panel display
- Wood Pellet Boilers
- Heat Recovery Systems
- Under Floor Heating
- Sheepswool Insulation
- Heat Pumps
- Water Saving Devices
- Photovoltaic Solar systems

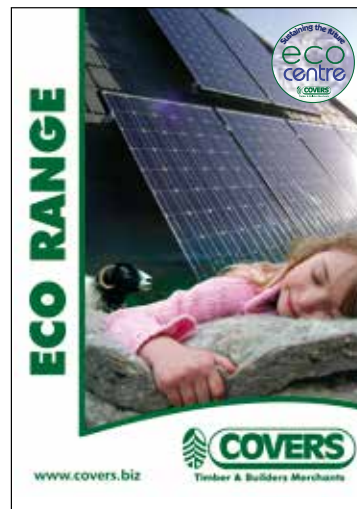
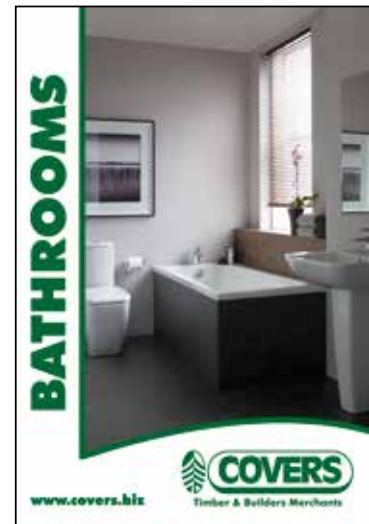
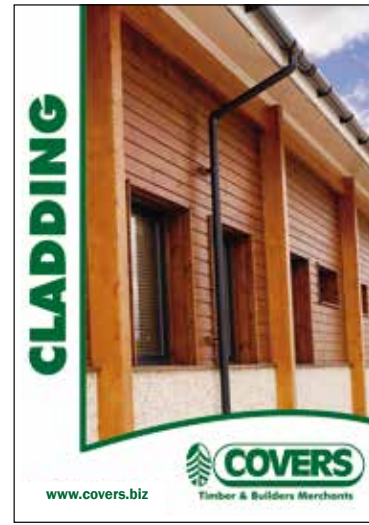
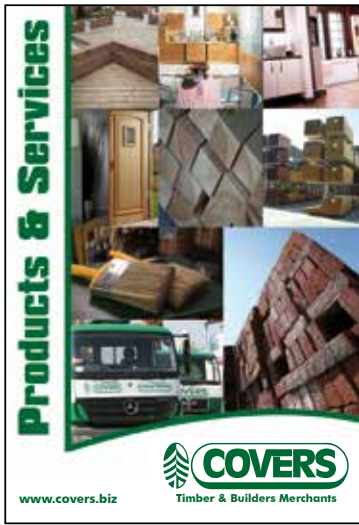

Pick up a brochure at any depot or download from
www.covers.biz



How would you like to pay? Cash or Account

Trade Card: If you prefer to pay as you go. You will get trade terms, which means you don't have to negotiate every time you pay.

Credit Account: We offer a 30 day account to qualifying customers on trade terms, so that you can buy everything at the right price, with account facilities of invoices and statements to your office and planned payments dates.*

* Credit references required. Terms and conditions apply.

Depot Account: This offers the benefits of a Credit Account in terms of invoices and statements but no credit is offered. Ideal for a small trader who may send one of their team to collect goods and does not wish to give them cash or to lose the invoices.

You can download the application forms for the above from our website www.covers.biz

Aldershot

Blackwater Park
Hampshire
GU12 4PQ
Tel: 01252 320554
Fax: 01252 341279
sales.aldershot@covers.biz
Mon - Fri : 7.30am - 5.00pm
Sat : 8.00am - 12.00pm

Alresford

3 Prospect Road
Hampshire
SO24 9QF
Tel: 01962 738666
Fax: 01962 738777
sales.alresford@covers.biz
Mon - Fri : 7.30am - 5.00pm
Sat : 8.00am - 12.00pm

Bognor Regis

Station Yard
West Sussex
PO21 1BT
Tel: 01243 863100
Fax: 01243 841215
sales.bognor@covers.biz
Mon - Fri : 7.30am - 5.00pm
Sat : 7.30am - 1.00pm

Brighton

Home Farm Road
East Sussex
BN1 9HU
Tel: 01273 607044
Fax: 01273 685208
sales.brighton@covers.biz
Mon - Fri : 7.30am - 5.00pm
Sat : 8.00am - 12pm

Burgess Hill

114 Fairfield Road
West Sussex
RH15 8NP
Tel: 01444 233358
Fax: 01444 248099
sales.burgesshill@covers.biz
Mon - Fri : 7.30am - 5.00pm
Sat : 8.00am - 12.00pm

Chichester

Quarry Lane
West Sussex
PO19 8PE
Tel: 01243 785141
Fax: 01243 533977
enquiries@covers.biz
(For opening times, contact individual department)

Gosport

Gunners Way
Hampshire
PO12 4DW
Tel: 023 9260 4400
Fax: 023 9260 4410
sales.gosport@covers.biz
Mon - Fri : 7.30am - 5.00pm
Sat : 7.30am - 1.00pm

Horsham

Foundry Lane
West Sussex
RH13 5PX
Tel: 01403 253123
Fax: 01403 240101
sales.horsham@covers.biz
Mon - Fri : 7.30am - 5.00pm
Sat : 8.00am - 1.00pm

Lewes

Cooksbridge
East Sussex
BN8 4TJ
Tel: 01273 476133
Fax: 01273 400164
sales.lewes@covers.biz
Mon - Fri : 7.30am - 5.00pm
Sat : 8.00am - 12.00pm

Portsmouth

Norway Road
Hampshire
PO3 5FT
Tel: 023 9267 1900
Fax: 023 9267 0350
sales.portsmouth@covers.biz
Mon - Fri : 7.30am - 5.00pm
Sat : 7.30am - 1.00pm

Rudgwick

Crinda Landscape Supplies
Brookside Rural Park
West Sussex RH12 3AU
Tel: 01403 824111
Fax: 01403 823405
sales.rudgwick@covers.biz
Mon - Fri : 7.30am - 5.00pm
Sat : 8.30am - 12.00pm

Southampton

Belgrave Road, Portswood
Hampshire
SO17 3AN
Tel: 02380 556996
Fax: 02380 679065
sales.southampton@covers.biz
Mon - Fri : 7.30am - 5.00pm
Sat : 8.00am - 12.00pm

Tunbridge Wells

Longfield Road, North Farm Ind. Est.
Tunbridge Wells
Kent TN2 3EY
Tel: 01892 533326
Fax: 01892 520132
sales.tunbridgewells@covers.biz
Mon - Fri : 7.30am - 5.00pm
Sat : 8.00am - 12.00pm

Head Office

Sussex House
Quarry Lane,
Chichester
West Sussex PO19 8PE
Tel: 01243 785141
Fax: 01243 531151
enquiries@covers.biz



Timber & Builders Merchants
www.covers.biz