

System:- NV1

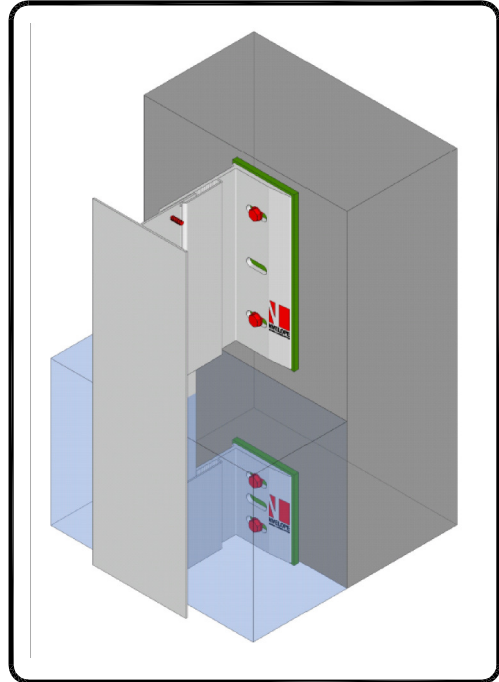

aluminium support system for  
rainscreen cladding

## NVELOPE NV1 SYSTEM



### LEGEND:

- A - Cladding
- B - Cladding-rivet
  
- 1 - SFS steel wall + cement board
- 2 - Nvelope - support bracket
- 3 - Stainless steel fixing
- 4 - T-(L) profile vertical
- 5 - Self drilling stainless steel screw SR2 4.2 x 16
- 7 - Thermal insulation
- 8 - Ventilation Cavity
- 10 - NVELOPE Thermal isolator

### CONTENTS:

- NV1-00 NVELOPE System detail sheet
- NV1-01 Tolerances for bracket adjustment
- NV1-02 Cladding view locations
- NV1-03 Horizontal section
- NV1-04a Typical section large bracket
- NV1-04b Typical section medium bracket and profile connection
- NV1-05 Vertical section-base of cladding
- NV1-06 Vertical section-top of cladding
- NV1-07 Horizontal section window jamb
- NV1-08 Vertical section window sill
- NV1-09 Vertical section window head
- NV1-10a External corner
- NV1-10b External corner with corner bracket
- NV1-11 Internal corner

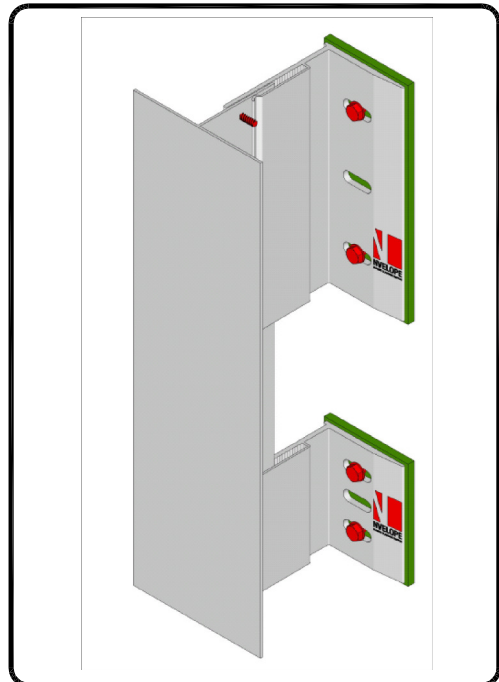

System:- NV1

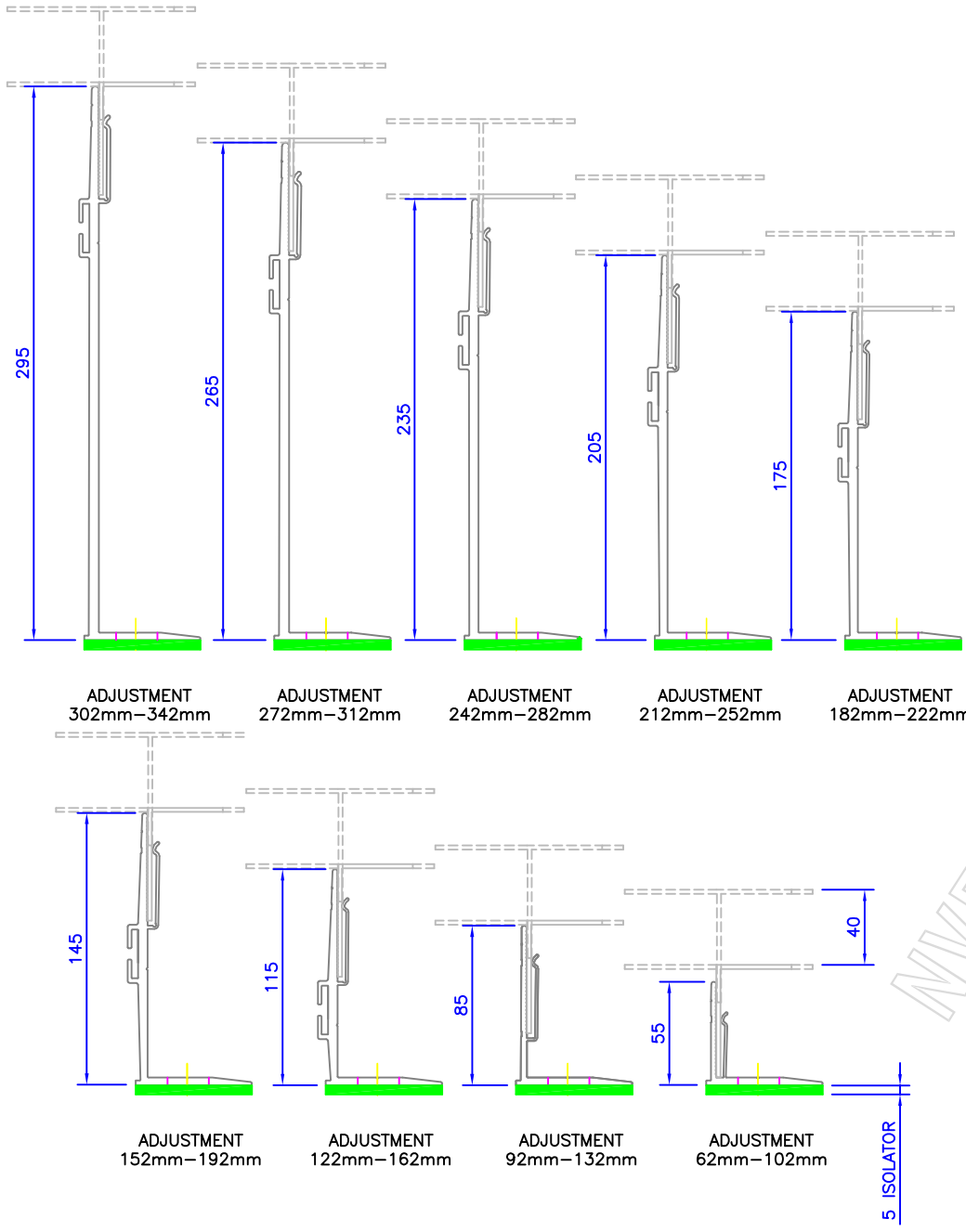

BRACKETS	Adjustment range for each bracket ( mm )	
Nvelope 60	from 62	to 102
Nvelope 90	from 92	to 132
Nvelope 120	from 122	to 162
Nvelope 150	from 152	to 192
Nvelope 180	from 182	to 222
Nvelope 210	from 212	to 252
Nvelope 240	from 242	to 282
Nvelope 270	from 272	to 312
Nvelope 300	from 302	to 342

HORIZONTAL SECTIONS  
TOLERANCES FOR ADJUSTMENT

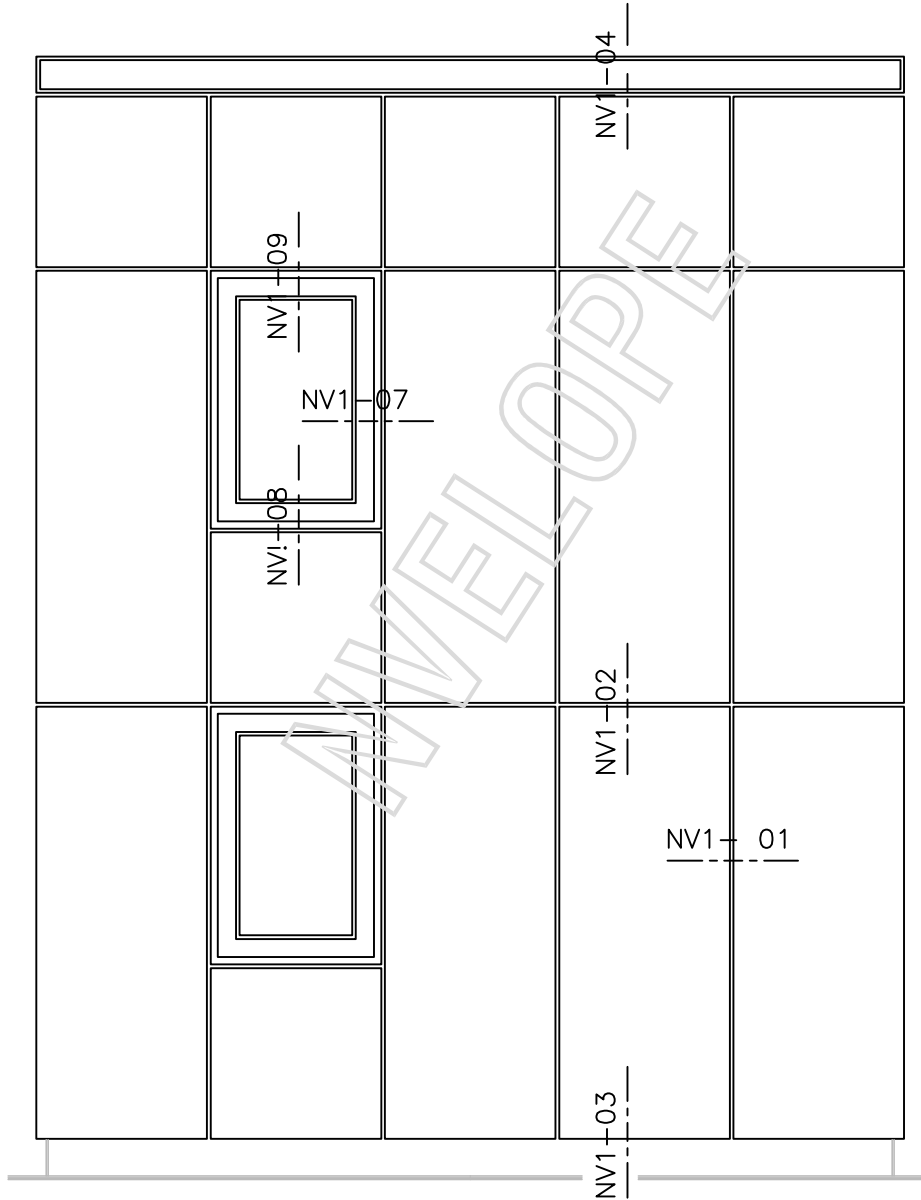

VIEW OF CLADDING - DETAIL LOCATIONS



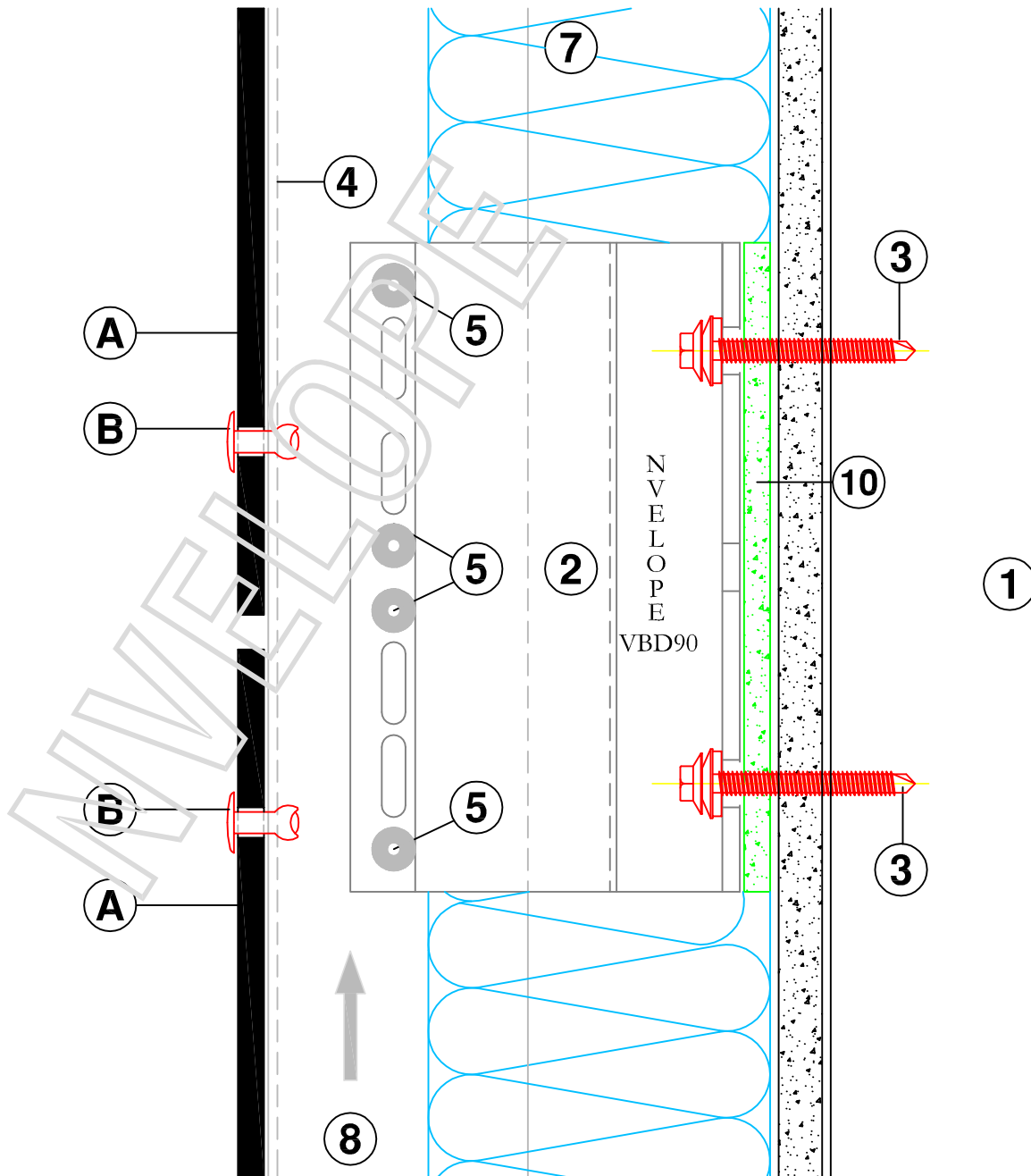

VERTICAL SECTION - NVELOPE L90 FIXED POINT

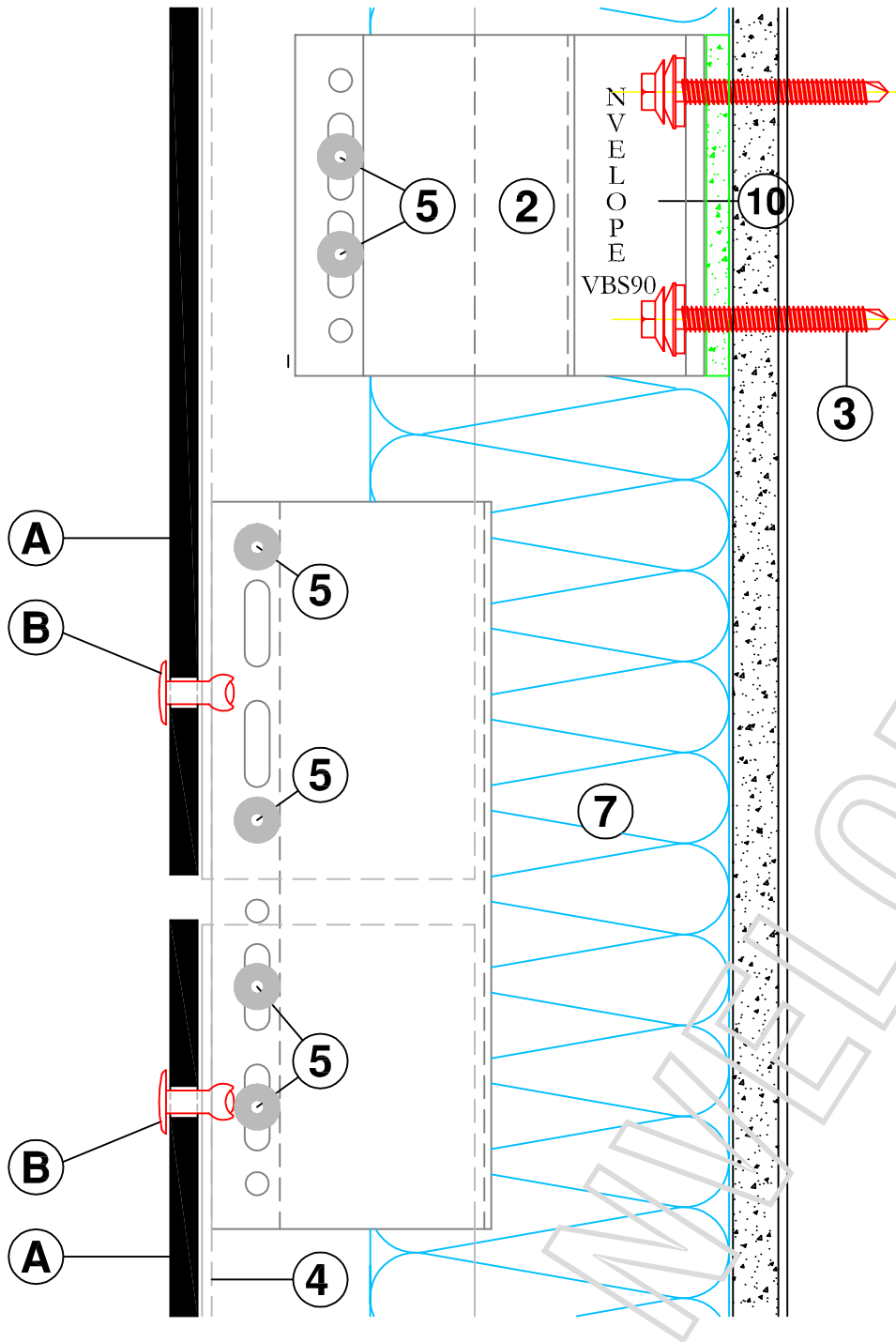

VERTICAL SECTION - RAIL JOINT OF PROFILE

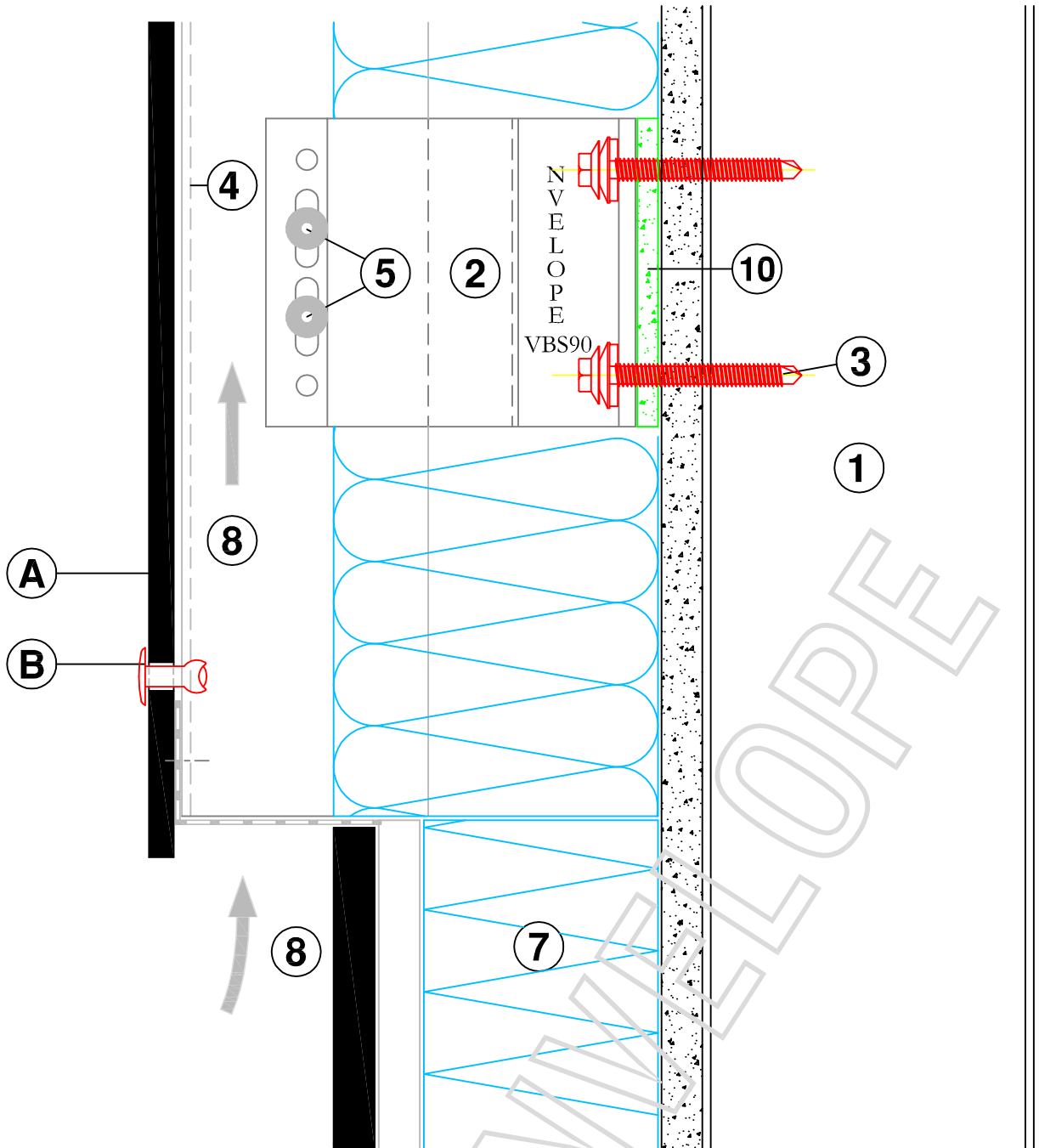

VERTICAL SECTION - BASE OF CLADDING

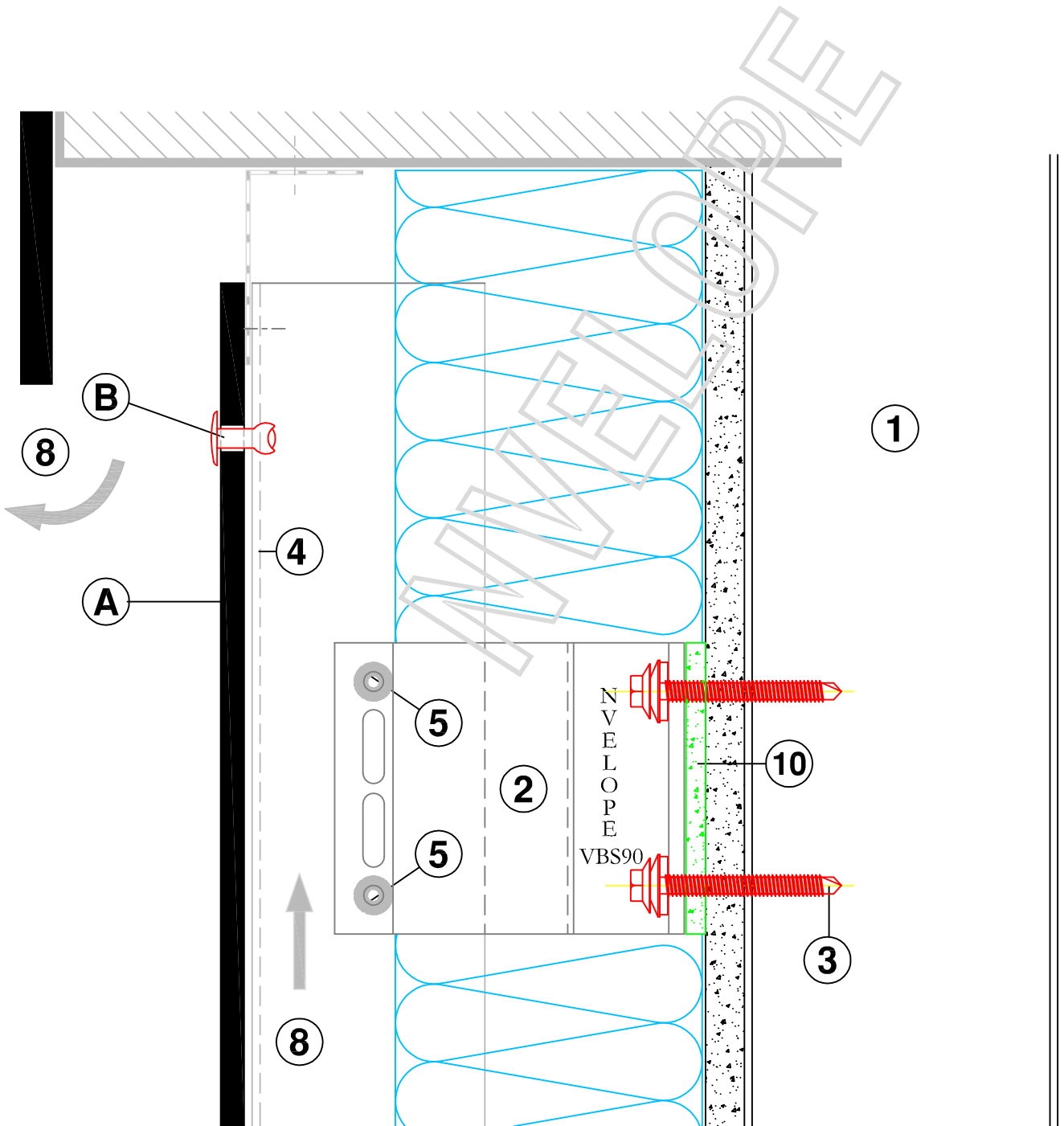

VERTICAL SECTION - TOP OF CLADDING



System:- NV1

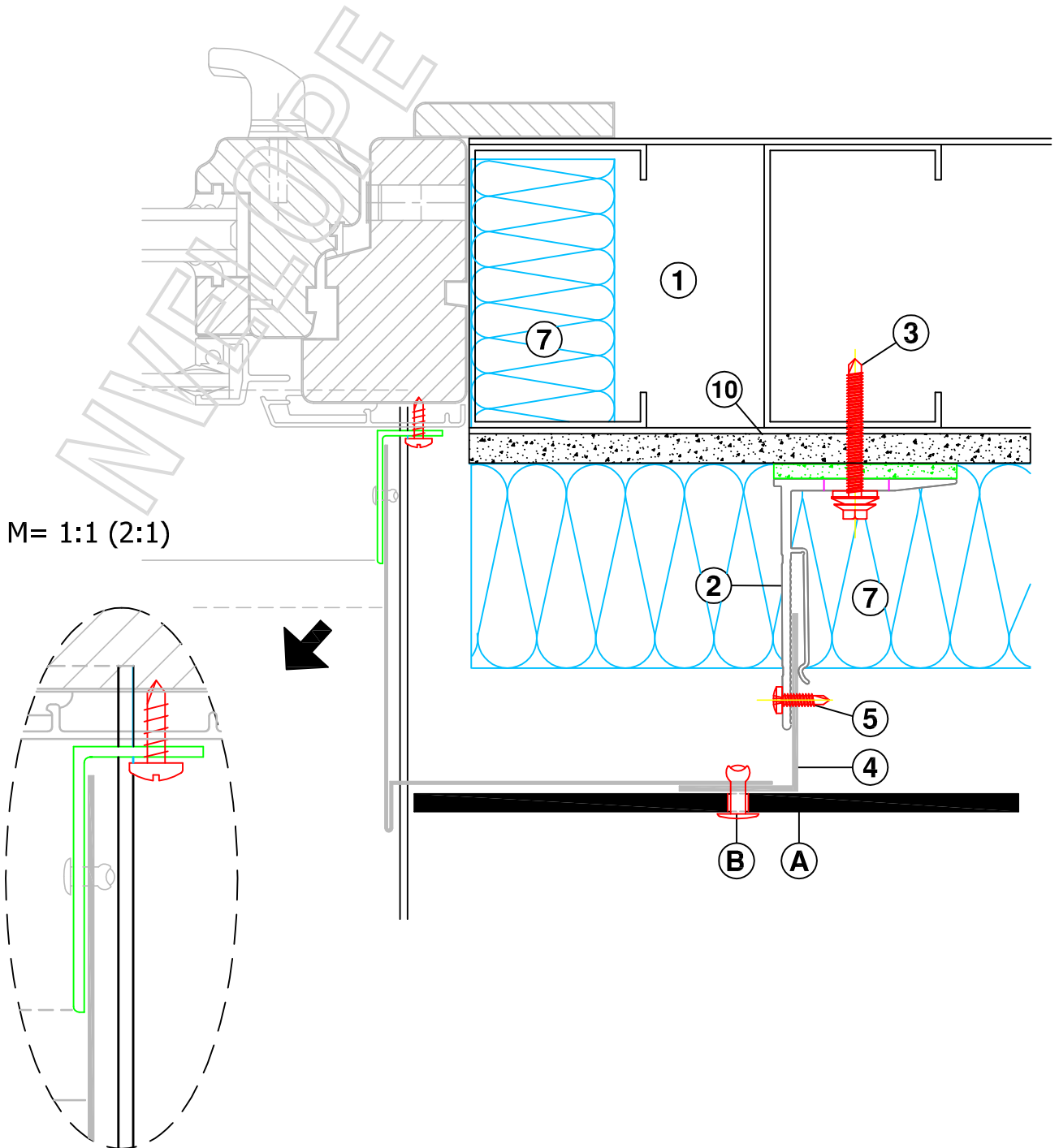

### HORIZONTAL SECTION - WINDOW JAMB DETAIL

NVELOPE RAINSCREEN SYSTEMS Ltd - tel - 01707 333396 - fax - 01707 333343

[nvelope.com](http://nvelope.com)

Detail Sheet :- NV1 - 07

System:- NV1

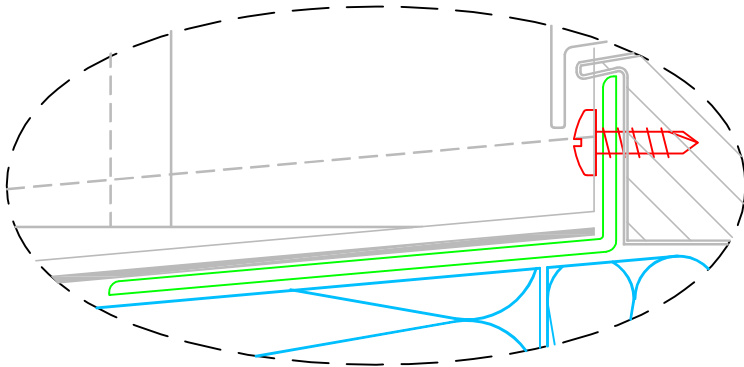

M= 1:1 (2:1)

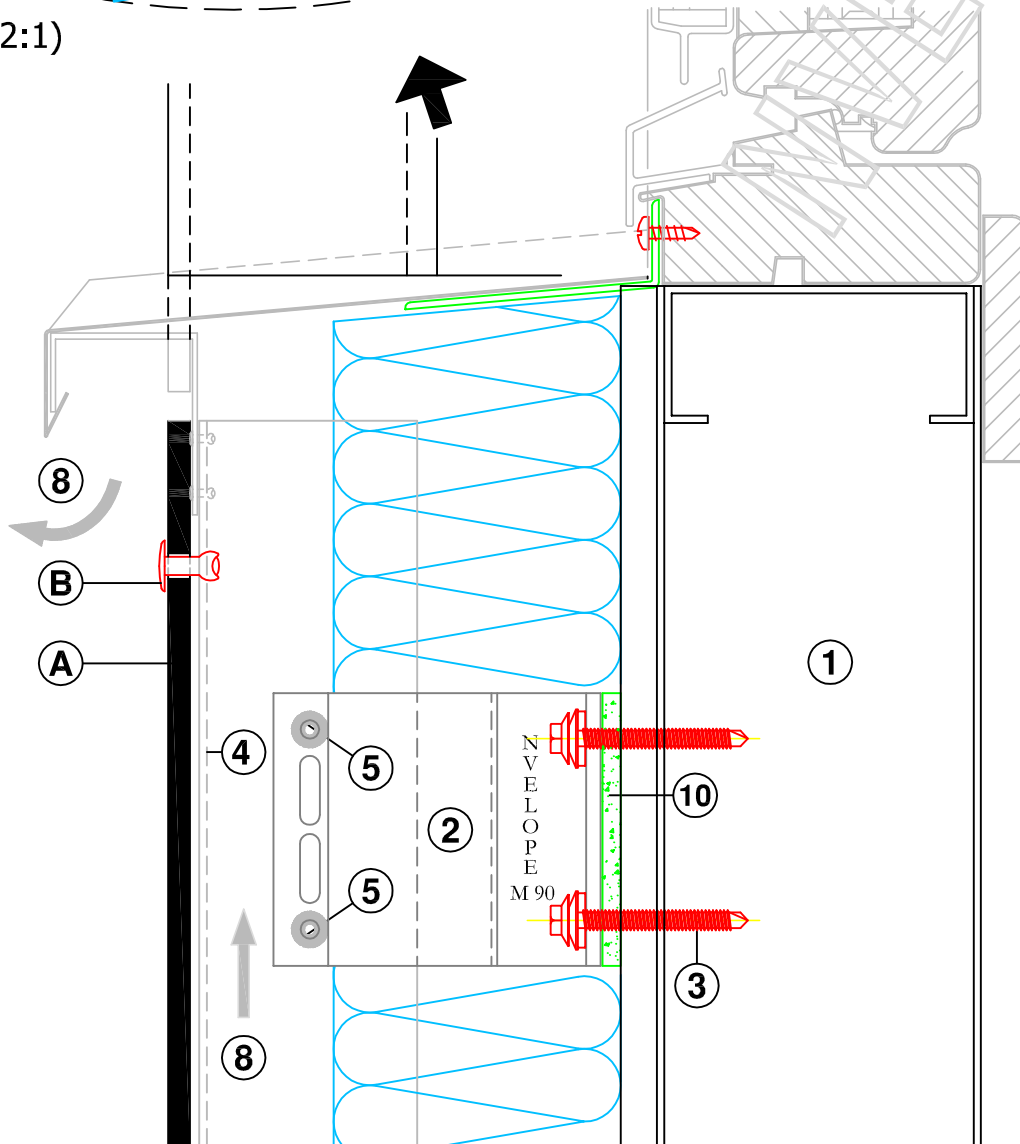

VERTICAL SECTION - WINDOW SILL DETAIL

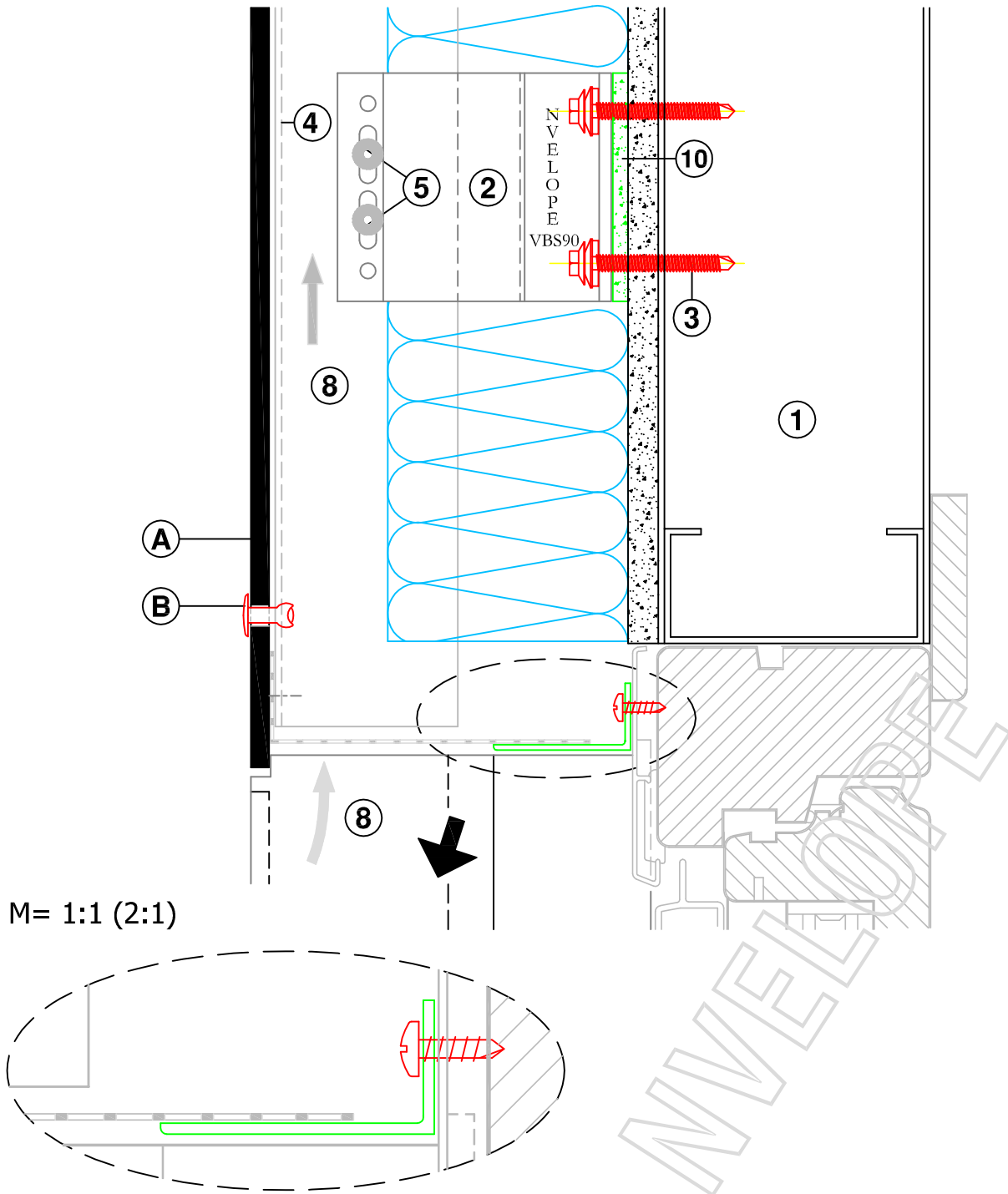

**VERTICAL SECTION - WINDOW HEAD DETAIL**

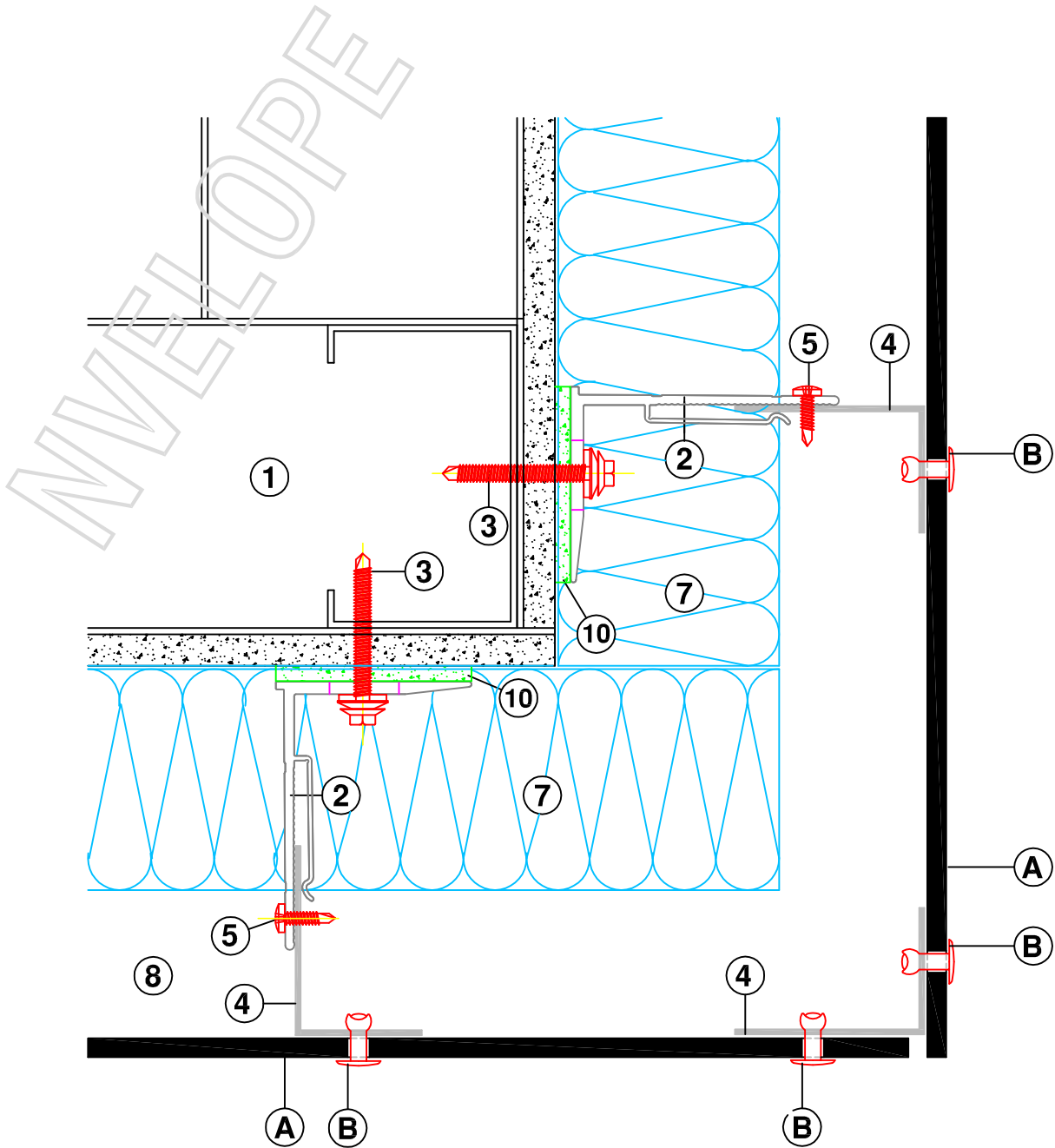

HORIZONTAL SECTION - EXTERNAL CORNER

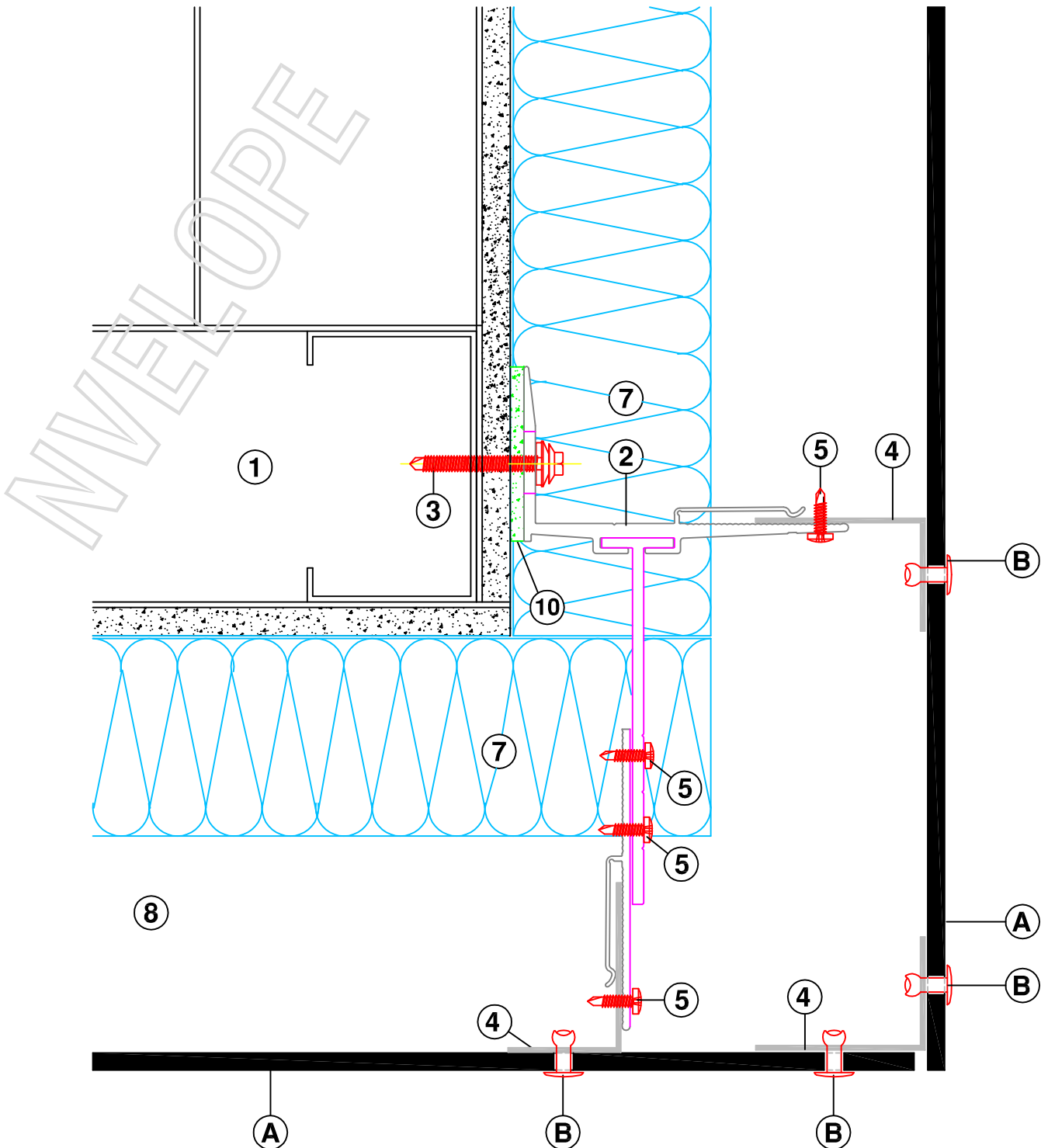

HORIZONTAL SECTION - EXTERNAL CORNER - WITH CORNER BRACKET

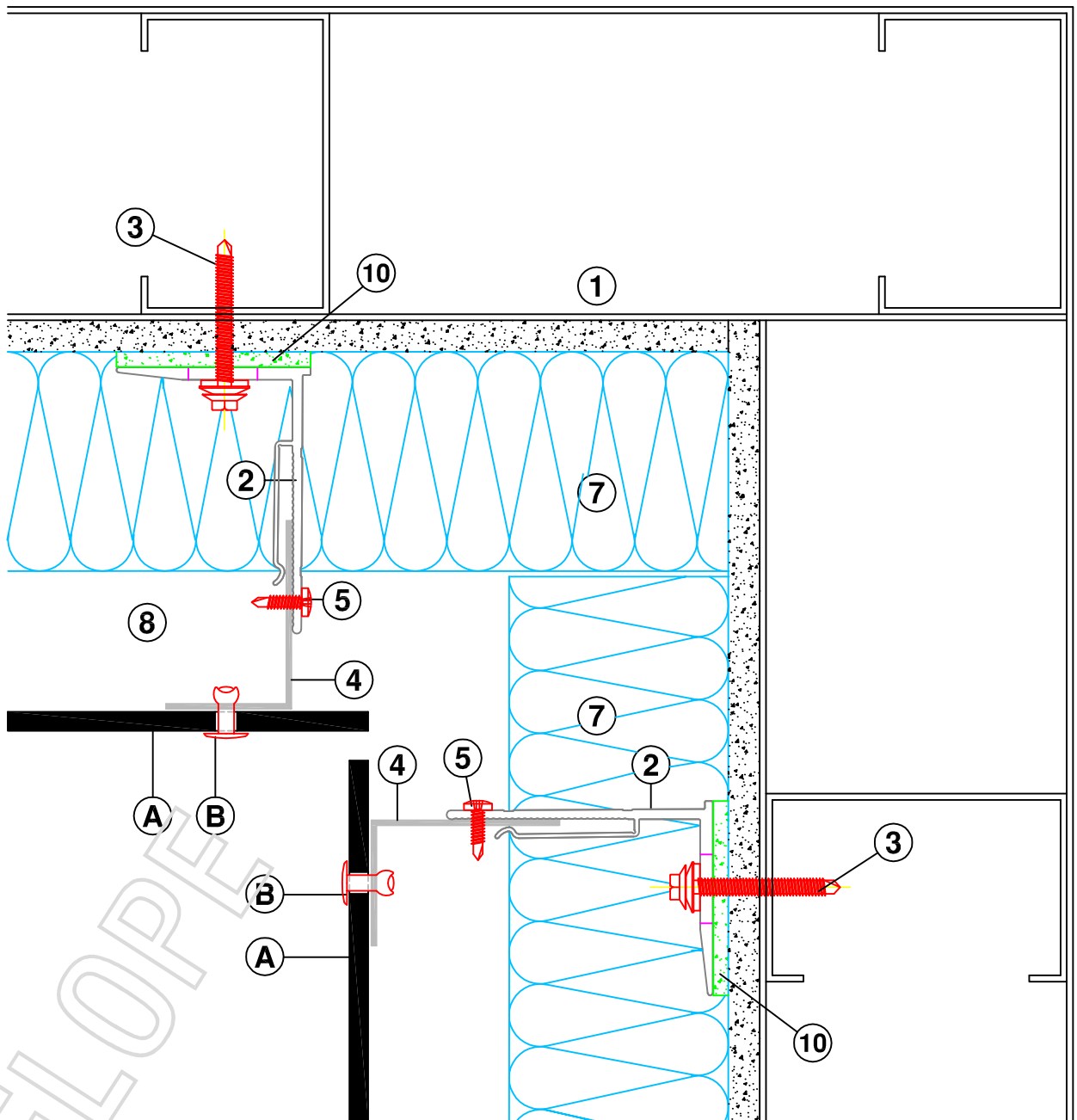

HORIZONTAL SECTION - INTERNAL CORNER