

# ATA Series

# AMELEC

Signal  Conditioning

## INDUSTRY STANDARD 'A' RANGE ATA SERIES TRIP AMPLIFIERS

The range includes AMT signal transmitters, ACC arithmetic units and AGS special products  
Please see our other catalogues

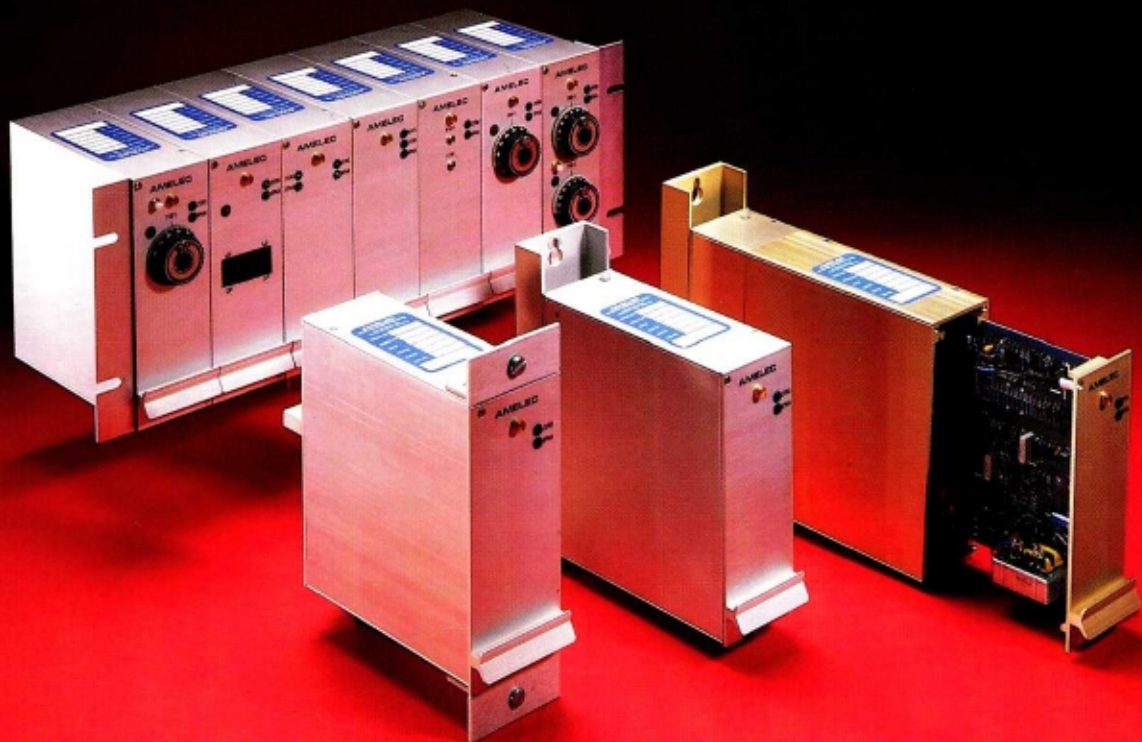

- Suitable for input from thermocouple, millivolt, RTD, sldewire or process signals.
- Models available for single channel - single trip, double trip or quadruple trip. Dual channel - single trip or double trip models have total isolation between channels.
- Trip points set by single turn lockable dial with 100mm scale length. Other controls easily accessible through the front panel.
- Supply voltages of 120VAC, 240VAC, or 24VDC available at no additional cost. All units individually fused and front panel supply indicators fitted.
- Digital indication of input and trip points may be specified, scaled as a percentage of input span or in engineering units.
- Certification to BASEEFA, CENELEC and BS5501, Part 7.
- RFI protection to BS6667, Part 3 available for all units.
- Manufactured and tested to BS5750, Part 2.
- AMELEC standard 10 year guarantee.

## About Us

Originally formed in February 1975, AMELEC remains a wholly owned British manufacturing company celebrating our 35th year anniversary. In 2010 & 2011 we were awarded **100% score** in **quality** accreditation by the Achilles-UVDB verify scheme.

The instrumentation that AMELEC offers to the market place is based on analogue techniques, using readily available discrete components. The instruments contain no time dependent or microprocessor circuitry, are suitable for use in SIL 1, 2 or 3 rated safety systems/loops & all covered by up to 10 Year warranty.

Our design & everyday application engineering principles used in the instruments are based on well tried, proven in use for over thirty years, linear operational amplifier circuitry. Each instrument can be considered as a number of functional blocks assembled together to produce a specific control function.

A Signal Conditioner / Transmitter would comprise of an input circuit; a modulator / demodulator stage; an output circuit and the power supply/regulation circuitry. A trip amplifier might use the same input circuit, this time a comparator and relay driver stage plus the power supply / regulation circuitry.

By combining these functional blocks together we have produced a comprehensive range of Trip Amplifiers, Transmitters, Signal Converters / Isolators, Signal Splitters/Boosters, combined Trip Transmitters, Arithmetic (Add / Subtract / Select / Multiply / Divide) units, Power Supplies, Strain Gauge, Frequency & AC I/V Transducers, as well as Hart compatible units. The circuit building blocks we use today are essentially the same as the ones we have used for the last thirty years.

To confirm that the instruments are compliant with the latest standards, AMELEC have submitted a range of instruments with all the various circuit blocks in them to the test houses. The reference / standards used at the test houses have been:- the CEGB's EES1989, the BS6667, IEC801 and more recently the IEC61000. All instrumentation produced by AMELEC is controlled under our Lloyds approved **ISO 9001:2008 Quality system**.

Our vast client base is spread across all process industry sectors; originally to the likes of the CEGB, BNFL, GEC, British Gas, ICI, BP & Shell, today AMELEC continues to supply quality instrumentation to the Nuclear, Power Generation, Oil & Gas, Chemical, Pharmaceutical, Petrochem, Utilities, Food & Brewery sectors, as well as to many other general manufacturing industries & the Water Authorities throughout.

### Here are some of our clients:



Tel: 01908-567003

E-mail: sales@amelec-uk.com

www.amelec-uk.com

Fax: 01908-566735

Cochran Close, Crownhill (Industry), Milton Keynes

MK8 0AJ



**Client Feedback**

*"I recently had one of your trip amplifiers go faulty on me. The said item is at least 21 years old, and had been in service for all this time. I was really pleased when you told me that you could supply me with a direct replacement that would not need any modifications done to make it fit. It is very rare for electronic equipment not to be obsolete after a couple of years, never mind 21 years!"*

*In all my dealings with your company I have always been impressed with the quality of your products. The manuals provided with each item are excellent, as is your after sales technical help. I think that your 10 years warranty speaks volumes about your faith in your products. I would never hesitate I recommending your company to anyone"*



*"Many thanks for your prompt response.....Great Service!"*



*"Thanks for the fast response."*



*"Thank you for the great service."*



*"Thanks again for the prompt response."*



*"Thanks for your support."*



*"This is just what we needed, so many many thanks."*



*"Many thanks for your very prompt service...we thank you for helping us on this urgent request, it is much appreciated."*



*"Thank you very much...please say thanks to Oscar & David."*



*"I'd like to thank you for your quick response to our request, and for getting the item to us on time"*



*"I just want to say thanks to you and your staff for your speedy response and efforts, received the unit yesterday and works a treat!"*



**Client Feedback**

*"I recently had one of your trip amplifiers go faulty on me. The said item is at least 21 years old, and had been in service for all this time. I was really pleased when you told me that you could supply me with a direct replacement that would not need any modifications done to make it fit. It is very rare for electronic equipment not to be obsolete after a couple of years, never mind 21 years!"*

*In all my dealings with your company I have always been impressed with the quality of your products. The manuals provided with each item are excellent, as is your after sales technical help. I think that your 10 years warranty speaks volumes about your faith in your products. I would never hesitate I recommending your company to anyone"*



*"Many thanks for your prompt response.....Great Service!"*



*"Thanks for the fast response."*



*"Thank you for the great service."*



*"Thanks again for the prompt response."*



*"Thanks for your support."*



*"This is just what we needed, so many many thanks."*



*"Many thanks for your very prompt service...we thank you for helping us on this urgent request, it is much appreciated."*



*"Thank you very much...please say thanks to Oscar & David."*



*"I'd like to thank you for your quick response to our request, and for getting the item to us on time"*



*"I just want to say thanks to you and your staff for your speedy response and efforts, received the unit yesterday and works a treat!"*

# Specification

## INPUT DATA

### Input source

For details see individual specification

### Open circuit response

For details see individual specification.

### Input Impedance (Voltage input)

>1Mohm at amplifier input. This will be shunted by burnout drive or input conditioning components.

## SUPPLY DATA

### Power supplies

AC models	115VAC $\pm$ 20%
	230VAC $\pm$ 20%
DC models	24VDC $\pm$ 2.5V

### Consumption

Single trip	3VA
Double trip	4VA
Quadruple trip	6VA

## OUTPUT DATA

### Response time

<400mSec. Unless otherwise stated.

### Relay specification

DP/DT for each trip point, unless otherwise stated. Contacts are rated at 250VAC, 5A, 100VA (Resistive).

### Relay function

Selected by PC link. Default is normally energised, relay to de-energise on trip (fail safe operation).

### Relay status

Indicated by a red LED for each trip, mounted on the front panel. Lit when relay is energised.

### Controls

ZERO	$\pm$ 25%
SPAN	$\pm$ 50%
TRIP	0-100%
DEADBAND	1-20%

## CONDITIONS

### Ambient temperature

Working	-20°C to +60°C
Storage	-40°C to +70°C

### Humidity

From 5% to 95% R.H.

### Vibration

1g at 15Hz to 150Hz.

## ELECTRICAL STANDARDS

### Insulation Input-contacts-earth-channel

1000V RMS continuous. 2000V for 20uSec. Derate to 500VDC for option 'K' enclosures.

### Fusing

Power supply fused. Spare fuse mounted on PCB.

## WIRING AND MOUNTING

### Terminals

For conductors up to 2.5mm<sup>2</sup>.

### Weight

1.5kg approximately, when mounted in enclosure.

### Position

Any position is acceptable.

### Types of mounting

Wall, panel, single end access and rack. Precision extruded aluminium construction. Standard units are Anodised, option 'K' units are 'Alochromed'.

### Additional protection

Enclosures are available to NEMA 12 oiltight, NEMA 4 watertight and IP54 for N-protection.

## PERFORMANCE

### Series mode rejection

<0.1% error for 50Hz input at 5% of span amplitude.

### Common mode rejection

<0.1% error for 250V RMS.

### Temperature effect on zero

<0.02% per °C.

### Temperature effect on span

<0.01% of span per °C or <0.1°C per °C, whichever is the greater.

### Temperature effect on suppression/elevation

<0.02% of suppression/elevation per °C.

### Supply voltage effect

<0.01% per % input change.

### Trip adjustment

Infinitely variable by single turn 260° dial on front panel, calibrated 0-100 and lockable. Alternatively, by multi-turn potentiometer accessible through front panel.

### Deadband

Standard 1%. Also available adjustable from 1 to 20% by single turn 260° dial or by multiturn potentiometer.

### RFI rejection

Standard enclosures are inherently RFI proof due to their solid aluminium construction. However, for extra protection to BS6667, specify option 'K'.

### Permissible input overload

mV input	20V
DC voltage input	200V
DC current input	500%
AC voltage input	200%
AC current input	500%
Resistance input	6V

# Trip amplifiers

## ATA110 series, thermocouple and millivolt

These units will accept input from any BS4937 and ISA B,E,J,K,S,R,T or Pallaplat thermocouple; or millivolt source.

Thermocouple input units have automatic cold junction compensation.

Normal minimum span 4mV, lower ranges available to special order.

Source resistance up to 1000ohms for specified performance.

Open circuit response may be specified as upscale or downscale.

Input impedance 1Mohm, shunted by burnout drive.

Trip level proportional to input voltage, or temperature when option 'G' is specified.

### Models available

INPUT	Single channel		Double channel	
	Single trip	Double trip	Single trips	Double trips
Thermocouple	ATA 111	ATA 112	ATA 113	ATA 118★
Millivolts	ATA 115	ATA 116	ATA 117	ATA 119★

★ These models also available as single input - quadruple trip

### INPUT WIRING

#### Single channel

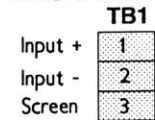

#### Double channel

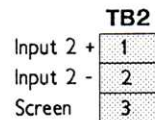
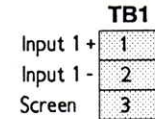

For output and supply wiring, please turn to page 10.

## ATA120 series, resistance temperature sensor

These units will accept input from any 2, 3 or 4 wire resistance temperature sensor.

Third wire compensation is standard to overcome lead resistance variation.

Normal minimum span 10 ohms, lower ranges available to special order.

Differential operation may be specified using 2 X 2 wire sensors.

Open circuit response is normally upscale but may be specified downscale.

Input and third wire drives are normally constant current, for improved linearity.

Trip level proportional to resistance, or temperature when option 'G' is specified.

### Models available

INPUT	Single channel		Double channel	
	Single trip	Double trip	Single trips	Double trips
Single	ATA 121	ATA 122	ATA 123	ATA 128★
Differential	ATA 125	ATA 126	ATA 127	

★ This model also available as single input - quadruple trip

### INPUT WIRING

#### Single channel

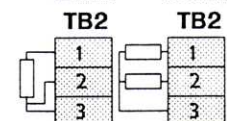
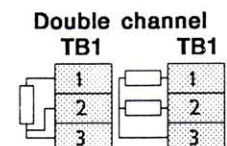
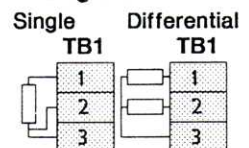

For output and supply wiring, please turn to page 10.



# Trip amplifiers

## ATA130 series, process

These models will accept input from any standard process voltage or current source.

Any current input from 0-100uA to 0-100mA or voltage input from 0-400mV to 0-200V may be used and any input may carry a 20% offset.

Voltage units have 1 Mohm input impedance.

On current units, the input shunt resistor absorbs only 400mV, allowing many units to be wired in series, even on a modest current loop.

### Models available

Single channel		Double channel	
Single trip	Double trip	Single trips	Double trips
<b>ATA 131</b>	<b>ATA 132</b>	<b>ATA 133</b>	<b>ATA 138★</b>

★ This model also available as single input - quadruple trip

### INPUT WIRING

#### Single channel

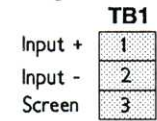

#### Double channel

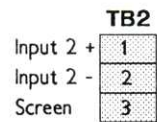
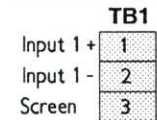

For output and supply wiring, please turn to page 10.

## ATA140 series, slidewire and potentiometer

These units will accept input from any 2 or 3 wire slidewire or potentiometer.

Third wire compensation is standard to overcome lead resistance variation.

Normal minimum span 100 ohms, lower ranges available to special order.

Differential operation may be specified using 2 X 2 wire sensors.

Open circuit response is normally upscale but may be specified downscale.

Input and third wire drives are normally constant current, for improved linearity.

Trip level proportional to resistance.

### Models available

INPUT	Single channel		Double channel	
	Single trip	Double trip	Single trips	Double trips
Single	<b>ATA 141</b>	<b>ATA 142</b>	<b>ATA 143</b>	<b>ATA 148★</b>
Differential	<b>ATA 145</b>	<b>ATA 146</b>	<b>ATA 147</b>	

★ This model also available as single input - quadruple trip

### INPUT WIRING

#### Single channel

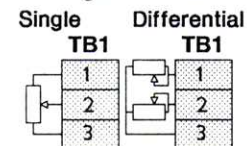

#### Double channel

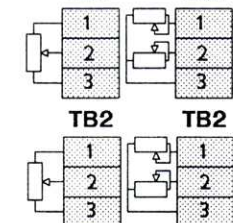

For output and supply wiring, please turn to page 10.

# Special trip amplifiers

## ATA134, valve positioner

Two inputs are provided. The first will accept any standard process signal and is intended as the primary input. The second will accept input from a potentiometer or slidewire, mechanically linked to the valve and is intended as a feedback signal.

Any potentiometer or slidewire may be specified, from 100 ohms to 10,000 ohms.

A>B or B>A deviation is set by a single blindset potentiometer, representing 0-100% of span.

If the two inputs deviate by more than the level set on the Trip potentiometer, 'Raise' or 'Lower' contacts will close until the valve moves sufficiently to restore the inputs to normal.

Adjustable deadband is fitted, controlled by a blindset potentiometer, to accurately control the point at which the 'Raise' and 'Lower' contacts return to normal.

### INPUT WIRING

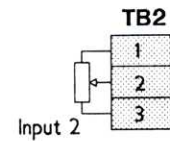
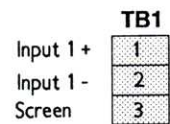

For output and supply wiring, please turn to page 10.

## ATA135, wide calibrated deadband

This unit is based on the ATA132 single channel, double trip but is intended for use in an application where Trip occurs at one level and Return to normal at a different level.

Both Trip and Return to normal are set by single turn lockable dials, representing 0-100% of span.

In a typical high trip application, Trip 1 will change state when the input exceeds the level set on the upper dial. It will then latch and not return to normal until the input falls below the level set on the lower dial.

Trip 1 relay has double pole changeover contacts while Trip 2 (Return to normal) contacts are single pole changeover.

### INPUT WIRING

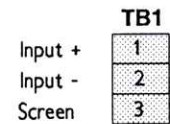

For output and supply wiring, please turn to page 10.

## ATA139, process input deviation trip

This unit will compare two inputs which need not necessarily be of the same type but do share a common 0V.

The upper trip will change state when Input 1 exceeds Input 2 by more than the level set on the upper dial. The lower trip will change state when Input 2 exceeds Input 1 by more than the level set on the lower dial. Both dials represent 0-100% of span.

Adjustable deadband may also be fitted, controlled by blindset potentiometers, to accurately control the point at which the trip relays returns to normal. Deadband potentiometers represent 1-20% of span.

### INPUT WIRING

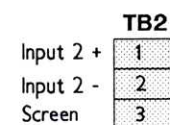
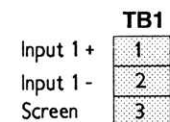

For output and supply wiring, please turn to page 10.



# Special trip amplifiers

## ATA150 series, AC voltage or current

### INPUT WIRING

Single channel

These units will respond to the amplitude of an AC voltage or current input.

No external transformers are required when monitoring mains supplies. Voltages between 150V and 600V or currents between 1A and 10A are isolated and converted by appropriate transformers mounted on the back plate.

### Models available

INPUT	Single trip	Double trip
Current	ATA151a	ATA151b
Voltage	ATA152a	ATA152b

	TB1
Input	1
Input	2
Screen	3

For output and supply wiring, please turn to page 10.

## ATA151TX, supply monitor

This unit is designed to monitor the mains supply and will go into a trip condition when the supply exceeds the level set on the upper dial.

A timer is fitted to allow a delay to be set between the overvoltage condition occurring and the relay contacts changing state. This time delay is adjusted by the lower dial.

No separate input is used. A transformer is mounted on the back plate to isolate the supply from the electronics and reduce it to a safe level.

In operation, when the supply exceeds the trip level, the upper LED lights, indicating that overvoltage has occurred. If the condition persists until the timer has timed out, the relay will change state and the lower LED will light.

If normal conditions are restored before the timer has timed out, the unit resets and both LEDs turn off. The same will occur if the voltage returns to normal when the unit is already in trip. There is no time delay; reset is immediate.

There is no separate input wiring on this product

## ATA170 series, strainguage

### INPUT WIRING

The 170 series will accept input from - and supply excitation to - devices such as strain-gauges or solid state devices using strainguages to monitor pressure, level, flow etc.

Normal minimum input span is 4mV but lower ranges may be specified to special order.

Unit has the facility of very large zero elevations to give a TARE effect in weighing applications. This elevation may be up to  $\pm 400\%$  of span.

Excitation voltage may be adjusted from 3V to 24V and will supply up to 20mA at a regulation of 0.1%. When higher excitation current is required, a range of separately mounted power supplies are available which will supply up to 1A.

### Models available

Single trip	Double trip
ATA171	ATA172

	TB1
Input +	1
Input -	2
Screen	3

	TB2
Excitation +	1
Excitation -	2
Screen	3

For output and supply wiring, please turn to page 10.

# Special trip amplifiers

## ATA180 series, pulse

### INPUT WIRING

These units will monitor the frequency of any regular repetitive pulse train.

Any waveform may be used provided the positive peak levels exceed the threshold level.

The threshold level is adjustable over a wide range to assist in the suppression of input noise.

Any input frequency between 0-25Hz and 0-20,000Hz may be specified.

Input level may be anywhere between 50mV and 30V p-p.

Response time is determined by input frequency. Typically it is less than 500mS but for full scale frequencies under 1000Hz it will be proportionately increased.

Unit may be AC coupled where large DC levels have to be accommodated.

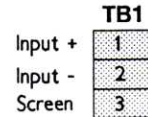

### Models available

Single trip	Double trip
ATA 181	ATA 182

For output and supply wiring, please turn to page 10.

## ATA190 series, motor winding temperature

### WIRING

These units are specifically designed for three phase motor winding temperature applications.

Models will accept input from three thermocouples or RTDs which are embedded in the motor windings. All three circuits are totally isolated from each other.

Each of the three inputs is compared with it's own individual Trip set point and if any exceed that trip point the unit will go into trip.

In the event of any winding overheating there are two outputs. The first is a single pair of contacts, which may be specified as normally open or normally closed. These are used to indicate which particular winding has overheated. Each of these three outputs has a LED status indicator.

The second output is the main control relay with single pole changeover contacts which will change state if any of the three trip circuits operate.

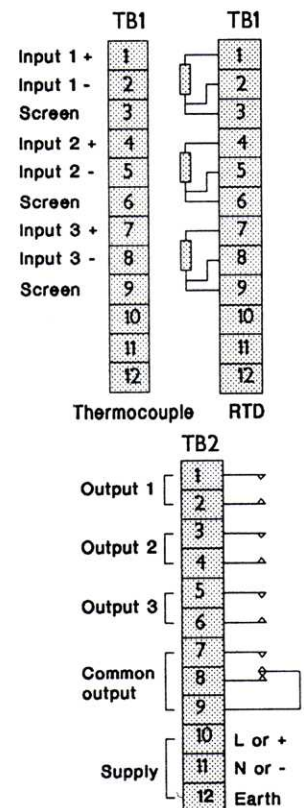

### Models available

Thermocouple	RTD
ATA 191	ATA 195



# Options

## Option 'DI', digital display

This is a 3½ digit indicator which is available in 8mm red or green LED or 12mm LCD. It will display any level from -1999 to +1999 and has it's own internal gain and offset controls allowing, for instance, full scale indication over a small portion of actual input span.

When this option is specified, the calibrated trip dials are replaced with blindset potentiometers and 'READ' pushbuttons for each trip point.

Under normal conditions, the display will indicate the input to the unit, either as a percentage of total input or in engineering units. When a pushbutton is pressed, the display will indicate that tripset level, in the same units, allowing very accurate adjustment.

Available with most of the options listed below.

## Option 'M', power supply

When fitted, this allows a standard unit to provide power to an external device, such as a strain gauge, input pre-amplifier or a 2-wire transmitter.

The output is adjustable over the range 2-25V at any current up to 25mA by an internal potentiometer which may, optionally, be fitted to the front panel. Load variation is better than 10mV over the full current range.

Depending on application, the output of this power supply may be wired to terminal block 2 or to unused terminals on terminal block 3. When used to power a 2-wire transmitter, the power supply output is wired internally on the unit in series with the current sensing shunt resistor, allowing full 2-wire operation.

Available with most of the options listed below.

## Other options

Suffix	Description
/B	Remote tripset potentiometers
/C	Ten turn tripset potentiometers with calibrated dials.
/DA	Analogue indication of input or trip level.
/J	Input test injection jack.
/K	RFI protection to BS6667 Part 3.
/L	Latched relay - normally reset by pushbutton on front panel.
/P	Calibration test point.
/S	Sealed relay.
/T	Timed relay - optionally with timer control mounted on the front panel.
/V	Variable deadband (1-20% of span).

Some combinations of options are physically incompatible. If in doubt, please contact our Technical Sales.



# Mounting and wiring

All the units in the range are supplied in an Anodised or Achromed extruded aluminium enclosure which may be surface or panel mounting, single end access or 7 way 19" rack.

When a unit is fitted into an enclosure, the edge connector at the rear of the main printed circuit board mates with a socket which is wired to the terminal blocks. The unit is retained in the enclosure by two M3 screws which pass through countersunk holes in the front panel and into tapped holes at the front of the enclosure.

The 'U' channel terminal cover is supplied in two sizes to suit different mounting requirements. For surface mounting units, the 217mm length is supplied and includes the fixing holes. For panel, single end access or rack mounting, the 178mm length is supplied but only when options 'K' or 'EXI' are specified. When supplied, they must be be replaced after wiring.

Units may be mounted at any orientation although they would normally be mounted with the front panel vertical. Surface or single end access units should not be mounted closer than 61mm horizontally or 218mm vertically. Panel units should not be mounted closer than 70mm horizontally or 234mm vertically and racks should not be mounted closer than 485mm horizontally or 189mm vertically. All types would normally be mounted further apart than this to ease wiring. At least 180mm must be left at the front of all enclosures to allow for unit withdrawal.

In the following drawings, all dimensions are in mm. Figures in brackets show the added depth of the 'K' enclosures to house the RFI protection components.

## Surface mounting

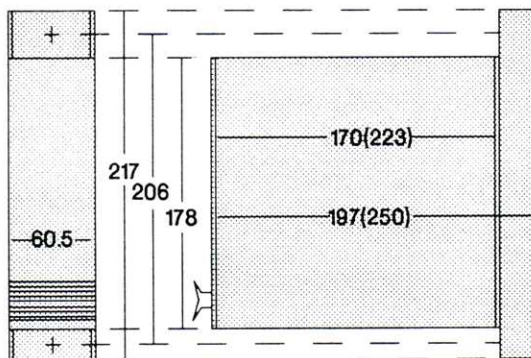

Before wiring, the unit must be withdrawn from the case, which may then be removed from the 'U' channel by undoing the M4 screw at the top rear of the case, hinging the case downwards and unhooking it from the fixed peg at the lower rear of the case. This exposes the terminal blocks for wiring.

Slots are provided in the terminal plate which allow cables to be passed along the 'U' channel, through the slots and into the terminal blocks. After wiring, the enclosure may be reassembled by reversing these instructions.

## Panel mounting

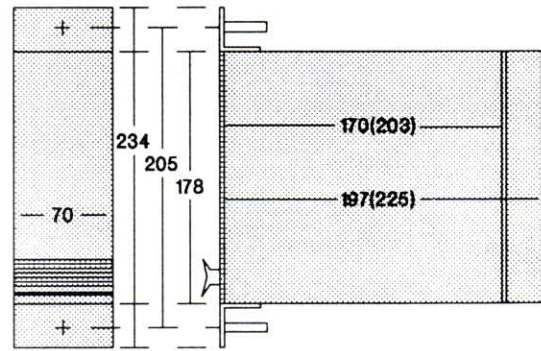

A 65mm wide by 190mm high aperture must be cut in the front panel with 6mm fixing holes above and below. The brackets and front panel are wider than the aperture to obscure any cut edges.

## Single end access

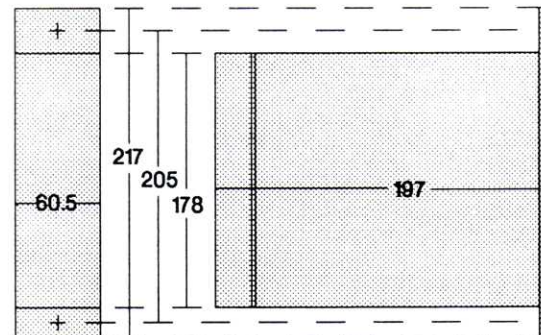

This enclosure is not recommended for use with option 'K'

In this arrangement the terminal blocks are mounted on the front panel, although the enclosure is surface mounted. Since the terminals are on the removable part of the unit, allowance must be made, when wiring, to allow for unit withdrawal without disturbing the wiring to adjacent units or the main loom.

## 19" Rack mounting

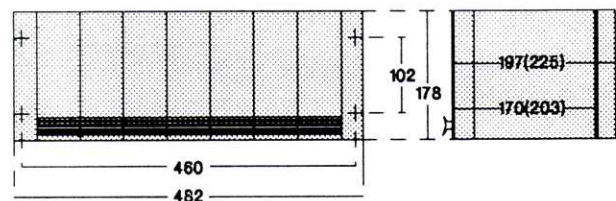

Up to seven units may be mounted in a 19" rack, although other widths may be supplied to suit special requirements.

The rack is normally supplied with fixing brackets to suit panel mounting (as shown above) but may also be supplied for single end access if required.

A 179mm high by 440mm wide aperture must be cut in the panel with fixing holes on 102mm by 460mm centres.



# Mounting and wiring

## WIRING

Input, output and supply connections are made via leaf type terminal blocks which are mounted on the front of single end access enclosures and at the rear on all other 'A' series types. These terminal blocks will accept cables up to 2.5mm<sup>2</sup>.

On most enclosures, other than panel mount, the terminals are separated into two groups by an earthed barrier which is part of the terminal mounting plate.

This barrier, together with the 'U' section terminal cover, ensures that input cables must enter from the top of the unit and supply/output cables from below. This helps meet the requirements of 'N' protection for intrinsically safe installations.

## Input wiring

This is given in the individual specification sheets for the various instrument types.

### Input access

This is almost invariably from the left, except where shown otherwise. This convention has been followed on input wiring drawings.

## Relay wiring

The following drawings show the outputs available for the standard range of products. Where output wiring differs from these, details are given in the individual specification sheet.

Single channel single trip

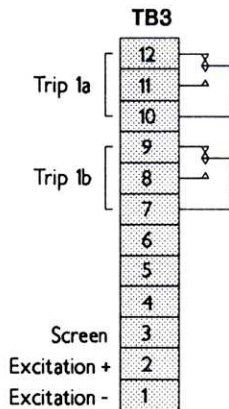

The excitation supply shown in the above drawing is the alternative wiring when option 'M' is fitted. The single relay has double pole changeover contacts.

Single channel double trip  
Double channel single trip

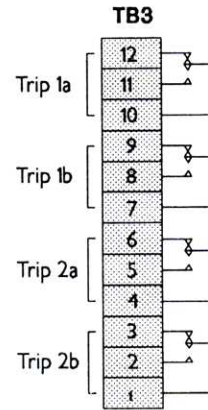

The two relays have double pole changeover contacts

Double channel single trip  
Single channel quadruple trip

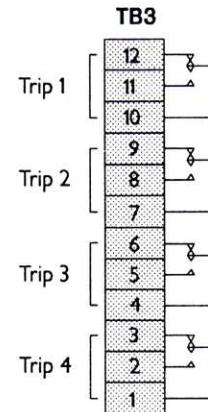

On single channel double trip units, Trips 1 and 2 are operated by the first channel; trips 3 and 4 by the second. On quadruple trip units, all four operate from the single input. The four relays have single pole changeover contacts.

## Output access

For panel, single end access or rack mounting units, output wiring access is from the right. For surface mounting units, wiring access is from the left, as shown above.

## Supply wiring

DC Supply

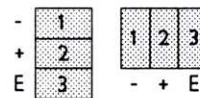

AC Supply

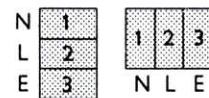

## Supply access

For panel, single end access or rack mounting units, output wiring access is from below. For surface mounting units, wiring access is from the left.

# Additional information

## Expansion to the range

The 'AH' range is still comparatively recent and is constantly being expanded. If the application you require is not covered in this catalogue, please contact our Technical Sales Department as the product may already be in process of being engineered.

## AGS products

Over the years, Amelec have been called upon to solve a wide variety of process control problems. Many of the resultant products have proved so successful they have become part of our standard range. Indeed, some appear in this catalogue as standard products.

Other products, however, are specifically designed to solve a particular problem. These models do not have sufficient demand to become standard products but, since they are manufactured to the same standard, they are kept on file, ready to solve similar problems for subsequent clients.

If you have a process control problem, please ask for our shortform AGS list. Alternatively, contact our Technical Sales Department, giving full details of the problem and they will either recommend an existing AGS product or design one to suit your particular application.

## Warranty and service

All Amelec products are guaranteed for ten years against faulty components or manufacture but not against misuse.

To claim under this warranty, equipment should be returned, carriage paid by the customer, to Amelec Instruments, Cochran Close, Crownhill, Milton Keynes, MK8 0AJ, together with details of the fault.

Attempted repairs or component replacement during the warranty period may render the warranty null and void, unless authorised by Amelec.

Amelec will undertake any repairs and will also supply replacement printed circuit board assemblies on an exchange price basis. Please contact the Technical Sales Department for further details.

Where the reported fault is a site problem, Amelec will make their own technical staff available to offer assistance. This service will be charged to the customer at the rate currently in force.

## Ordering

**When ordering, please give the following details:-**

1. Model number
2. Supply voltage and frequency
3. Mounting - Surface, Panel, Single end access or Rack
4. Input span, output span, offset and source
5. Open circuit response - If not specified, default is upscale for thermocouple, millivolt and resistance input units, downscale for process
6. Relay status and mode - If not specified, default is normally energised and single trips are set to Hi, double trips to Hi/Lo. LEDs are lit when relays are energised
7. Any options required
8. Information appropriate to any options ordered



A complete range of Trip amplifiers, Signal conditioners and Arithmetic units are also available in these complementary ranges:-

**A** 4U X 12E Surface, Panel, SEA and Rack **AB** 3U X 7E Rack. **AD** DIN rail and Surface. **AH** 3U X 4E Rack

Please ask for our other catalogues

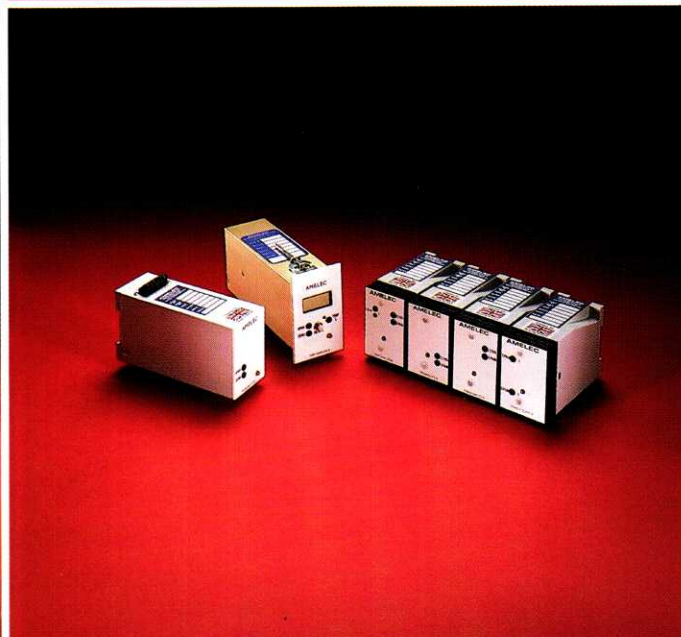
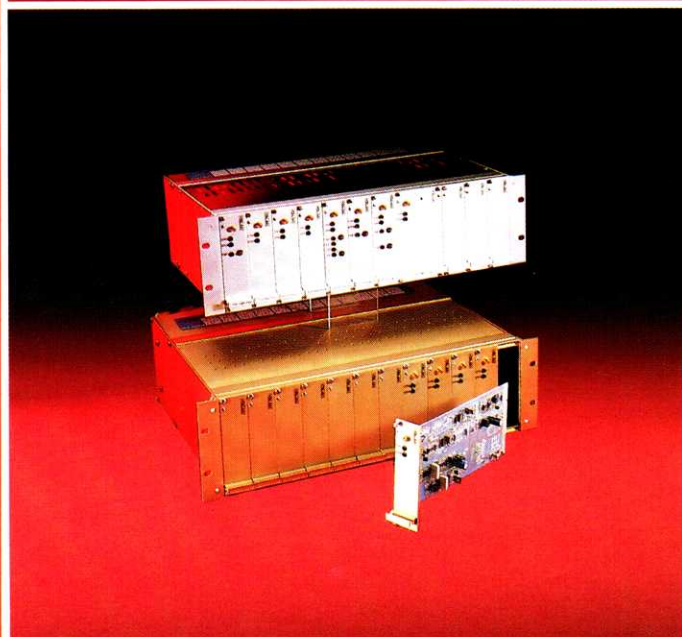
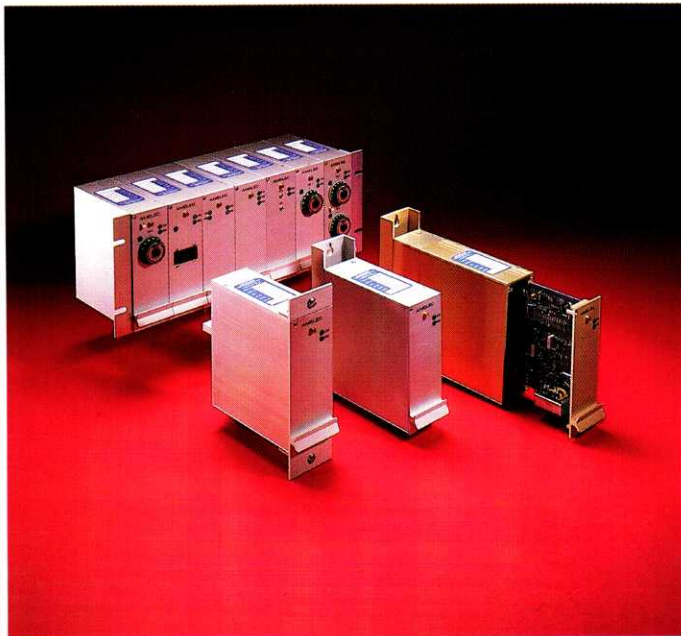
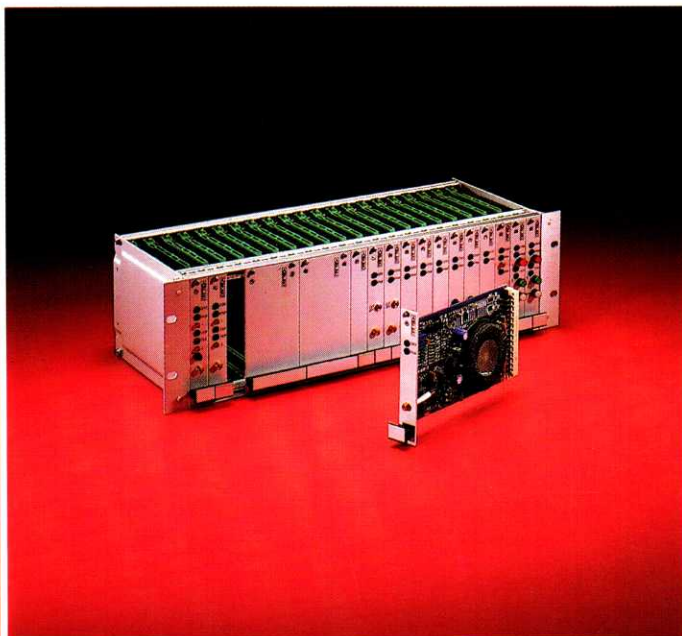

Cochran Close Crownhill Milton Keynes MK8 0AJ

[www.amelec-uk.com](http://www.amelec-uk.com) Tel: 01908 567003 Fax: 01908 566735 [sales@amelec-uk.com](mailto:sales@amelec-uk.com)