

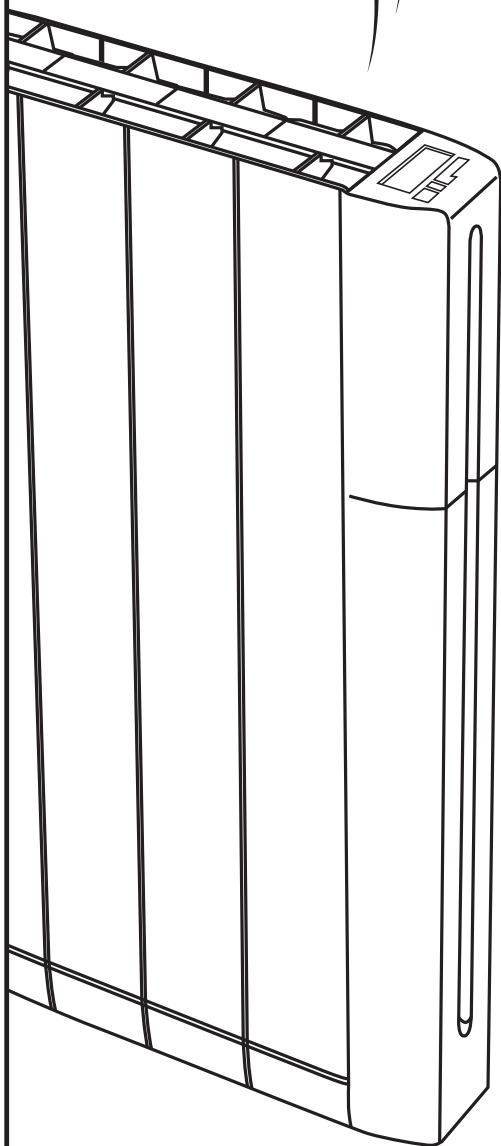

TECENOR

Técnicas Energéticas del Norte, S.A.



DIRECTIONS FOR USE

mod.

STYLE

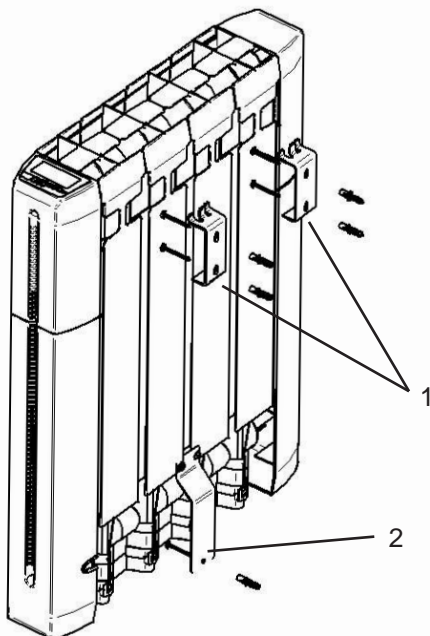
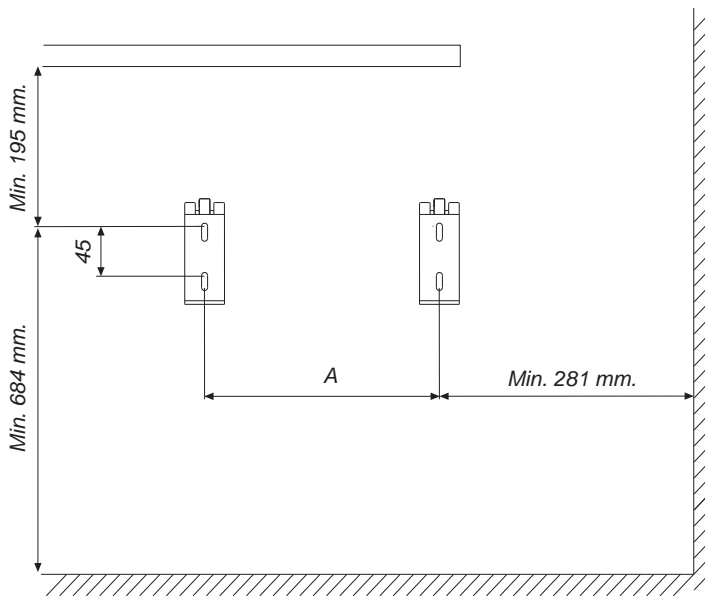

MODEL

A

4 elem.	158 mm.
6 elem.	316 mm.
8 elem.	474 mm.
10 elem.	632 mm.
12 elem.	790 mm.

ing case you can use
ill the holes for the

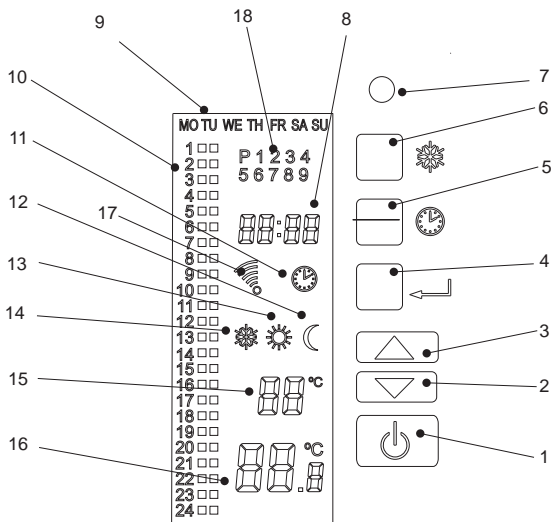

A. LEYENDA ; LEGENDE ; LÉGENDE ; LEGEND

1. ON/OFF button
2. DOWN button
3. UP button
4. CONFIRM button
5. PROGRAMMING button
6. ANTIFREEZE function button
7. LED (RED = radiator is working. Off = radiator is not working)
8. Clock
9. Days of the week: Monday, Tuesday, Wednesday, Thursday, Friday, Saturday, Sunday (MO, TU, WE, TH, FR, SA, SU)
10. 24-hour programming graph
11. OPERATING MODE indicator (manual or programmed)
12. ECONOMY MODE indicator
13. COMFORT MODE indicator
14. ANTIFREEZE MODE indicator
15. Operating temperature set by user
16. Current ambient temperature
17. Remote control reception indicator
18. Indicator of program number recorded from remote control

PRECAUTIONS

For safety reasons, remember to connect the appliance to a socket with a ground connection. This appliance should only be used with the wall supports provided in the assembly kit and following the ASSEMBLY INSTRUCTIONS.

Before connecting the appliance to the mains, ensure that the voltage matches that indicated on the characteristics plate.

Turn the appliance off at the control before plugging and unplugging it.

Do not pull the cable to unplug the appliance.

Do not place it under a fixed power point.

**DO NOT PLACE THE APPLIANCE NEAR A BATH, SHOWER OR SWIMMING POOL.
DO NOT IMMERSE THE APPLIANCE IN WATER.**

When you have finished using the appliance, unplug it.

If the connection cable is damaged, contact Technical Services to replace it.

Keep it away from combustible material (curtains, fitted carpets, etc.).

DO NOT COVER the appliance or place it near inflammable material. **RISK OF FIRE.**
The unit should be installed so that the plug is accessible.

ASSEMBLY INSTRUCTIONS

You are advised to assemble the appliance on an outside wall (where it is coldest) under a window. Adhere to the distances shown in figure 2.

Make six 6 mm holes following the measurements indicated in figure 2.

Affix the two wall supports (1) to the wall with the 4.2 x 38 screws and Rawlplugs provided in the assembly kit.

Hang the appliance from the two wall supports and push it against the supports until it “clicks” into place. Once the flange hole (2) has been fitted and used as a template, drill a 6 mm hole and attach it with a 4,2 x 38 screw and plug.

THE MANUFACTURER WILL NOT ACCEPT ANY RESPONSIBILITY IN CASES WHERE THE INSTRUCTIONS FOR THE INSTALLATION, MAINTENANCE AND USE OF THE APPLIANCE ARE NOT OBSERVED.

MOD. STYLE-D (Digital thermostat)

Operating instructions

After connecting and mounting the appliance according to the assembly instructions, press the ON/OFF button (⏻).

The display will light up and show the current room temperature (19.5) and the programmed temperature (21°C). If the unit is heating, the LED will come on. When it is not heating because the room has reached the desired temperature, the LED will go off.

To turn the unit off, press the ON/OFF button (⏻).

Temperature modes

With the appliance on, choose the temperature mode.

If the appliance is in economy mode, the (E) will be displayed and, if it is in Comfort Mode, the (S) indicator will be displayed. To switch between modes, press the temperature mode button (⊙).

Setting operating temperatures: ECONOMY and COMFORT

a. The radiator comes factory set with the following temperatures:

- Antifreeze: 7 °C (This cannot be changed by the user)
- Economy: 17 °C (Recommended programmed temperature. It can be changed by the user.)
- Comfort: 21 °C (Recommended programmed temperature. It can be changed by the user.)

b. These temperatures (ECONOMY and COMFORT) can be adjusted to suit your needs.

- To change these temperatures keep the PROGRAMMING button (⊙) pressed down for 3 seconds.
- The display will show the ECONOMY symbol (E) and the active temperature (17°C) will blink.
- Adjust this temperature as desired using the UP and DOWN buttons (▲ ▼).
- Once you have the desired temperature, CONFIRM the setting by pressing the (⏻) to store this temperature in memory.
- The COMFORT symbol (S) will then appear automatically and the active temperature (21°C) will blink.
- Adjust this temperature as desired using the UP and DOWN buttons (▲ ▼).
- Once you have the desired temperature, CONFIRM the setting by pressing the CONFIRM button (⏻) to store this temperature in memory.

Turning the display ON and OFF

a. If you wish to turn the display light off (for example, so it will not be a nuisance at night) do as follows:

- Press the CONFIRM button (⏻) for 2 seconds.

b. To turn on the display light on again, do as follows:

- Press the CONFIRM button (⏻) for 2 seconds, the light will blink and then remain on.

c. When the display light is turned off and you access any setting or programming mode, the display will light up. To turn it off again, repeat step "a" above.

d. The radiator will continue in operation whether the display light is on or off.

Enabling the Antifreeze function

The Antifreeze function has a programmed temperature of 7 °C. It is advisable, for example, when you are going to be absent for a prolonged period. Rather than turning the unit off, you can leave this function enabled so that, with a minimum expense, you can ensure the temperature in the house does not reach the freezing point with the ensuing risk of water pipes bursting and plants and pets dying. Press the Antifreeze button (⊙) to enable this function.

When the Antifreeze function is enabled the (S) symbol is displayed.

To disable the Antifreeze function, press the Antifreeze button (⊙) again and the (S) symbol will disappear from the display.

MOD. STYLE-C (Digital chronothermostat)

B. GENERAL INFORMATION:

1. The radiator has a MEMORY that stores programmed settings PERMANENTLY. The settings that are stored in memory are preserved even if the radiator is unplugged, there is a power outage, etc.
2. The internal clock continues to keep the time for approximately 40 minutes after the radiator is unplugged or there is a power outage.
3. After about 40 minutes without power supply, the TIME WILL BE ERASED but NOT THE SETTINGS. In such case, you will need to set the clock again, as described in section C-3 (Setting the clock).
4. The radiators DO NOT use batteries.









C. GENERAL INSTRUCTIONS:

1. Follow these instructions to properly mount the radiator on the wall.

2. First connection to mains:

- a. After mounting the radiator on the wall, connect it to mains.
- b. When the radiator is connected to an electricity supply for the first time the first day of the week will blink (MO: Monday). When MO is blinking, this means that you need to Set the clock as explained below.



3. Setting the clock:

- a. While the day (MO) is blinking, press the UP button  or the DOWN button  to select the current day of the week.
- b. After selecting the day of the week, press the CONFIRM button . Now the TIME (03:00) on the CLOCK will start blinking.
- c. Press the UP button  or the DOWN  button to select the current time and then press the CONFIRM button . At this time, the minutes (03:50) of the CLOCK will start blinking.
- d. Press the UP button  or the DOWN button  to select the current minutes and then press the CONFIRM button . After this operation, the transmitter will turn off automatically.





4. Setting and changing the day/hour/minutes of the radiator:

- a. If you wish to change the day, hour or minutes (because they were entered incorrectly, because of daylight savings time or for any other reason) follow the instructions below.
- b. Press the UP () and DOWN () buttons SIMULTANEOUSLY for 2 seconds. The active day will start blinking.
- c. Follow the same steps described in the previous section C. Setting the clock.
- d. After making the necessary changes, turn the transmitter off and on again.





5. Start up (ON/OFF) :

- a. To TURN ON the radiator press the ON/OFF button ( ). The display will show the current room temperature (19.5), the programmed temperature (22°C), the time (03:50) and the current day (WE).
- b. If the radiator detects the need to turn the heating on and does so, the green Indicator light (LED) will light up. When the heating is not on or stops because the desired programmed temperature has been reached, the green LED will go off. The LED will go on and off as the radiator turns on and off.
- c. To TURN OFF the radiator press the ON/OFF button () again. The display and the LED will turn off.

6. Operating mode: MANUAL or PROGRAMMED

- a. To find out the radiator's current operating mode, observe the radiator display. If you see the symbol , the radiator is in PROGRAMMED operating mode. If you do NOT see the symbol , the radiator is in MANUAL operating mode.
- b. To change between operating modes, TURN OFF the radiator by pressing the ON/OFF button (). Then, press the ON/OFF button () again for 5 seconds. The display will turn on, showing the current mode, and, after 5 seconds, it will BLINK showing the new mode. If it was in PROGRAMMED mode it will change to MANUAL mode and if it was in MANUAL mode it will change to PROGRAMMED mode.

c. MANUAL mode:

- The radiator works like a digital thermostat. That is, only the ON/OFF () and the temperature UP and DOWN ( ) buttons are functional.
- To turn on and off, see section 5, Start up (ON/OFF) above.
- To change the temperature use the UP and DOWN buttons ( ) to adjust them to the desired temperature.

d. PROGRAMMED mode:

- This mode allows you to program operating days and times and to set the temperature for each. See Chapter D for programming instructions.

7. Setting operating temperatures: ECONOMY and COMFORT

- a. The radiator comes factory set with the following temperatures:
 - Antifreeze: 7 °C (This cannot be changed by the user)
 - Economy: 17 °C (Recommended programmed temperature. It can be changed by the user.)
 - Comfort: 21 °C (Recommended programmed temperature. It can be changed by the user.)
- b. These temperatures (ECONOMY and COMFORT) can be adjusted to suit your needs.
 - To change these temperatures keep the PROGRAMMING button (⊗) pressed down for 3 seconds.
 - The display will show the ECONOMY symbol (C) and the active temperature (21°C) will blink.
 - Adjust this temperature as desired using the UP and DOWN buttons (▲ ▼).
 - Once you have the desired temperature, CONFIRM the setting by pressing the (←) to store this temperature in memory.
 - The COMFORT symbol (⊗) will then appear automatically and the active temperature (21°C) will blink.
 - Adjust this temperature as desired using the UP and DOWN buttons (▲ ▼).
 - Once you have the desired temperature, CONFIRM the setting by pressing the CONFIRM button (←) to store this temperature in memory.

8. Turning the display ON and OFF

- a. If you wish to turn the display light off (for example, so it will not be a nuisance at night) do as follows:
 - Press the CONFIRM button (←) for 2 seconds.
- b. To turn on the display light on again, do as follows:
 - Press the CONFIRM button (←) for 2 seconds, the light will blink and then remain on.
- c. When the display light is turned off and you access any setting or programming mode, the display will light up. To turn it off again, repeat step "a" above.
- d. The radiator will continue in operation whether the display light is on or off.

9. Enabling the ANTIFREEZE FUNCTION

- a. The ANTIFREEZE function has a fixed operating temperature of 7 °C. This function is advisable, for example, when you are going to be absent for a prolonged period during the cold season. In these cases, rather than turning the radiator off, you can leave this function enabled so that, with a minimum expense, you can ensure the temperature in the house does not reach the freezing point with the ensuing risk of water pipes bursting and plants and pets dying.
- b. There are 2 options:
 - First: If you press the ANTIFREEZE button (⊗) briefly, this function will be enabled temporarily, cancelling the programmed setting for the time being. The function will remain enabled until a new programmed hour (or time window) comes into effect.
 - Second: By pressing the ANTIFREEZE button (⊗) for 2 seconds, all programmed settings will be disabled and the radiator will only work in ANTIFREEZE mode. At this point, the symbol ❄ will blink and then stay on.
 - To cancel the ANTIFREEZE function, press the button (⊗) again until the symbol ❄ disappears. Once you have done this, the radiator will again resume operation as programmed.

D. PROGRAMMING INSTRUCTIONS

1. Once the radiator clock has been set (see General Instructions - Setting the clock) and the radiator is on, you can begin programming the unit.
2. The programming sequence is as follows:
 - a. First: Choose the day or the days to program (if you do NOT choose a given day, the radiator will remain turned off on that day).
 - b. Second: Choose the hours that you wish to program. The radiator allows you to program one hour at a time or 24 hours simultaneously (during those hours that have NOT been programmed, the radiator will stay off until the next user programmed hour).
 - c. Third: Choose the operating temperature for each programmed hour (below is an explanation of the 4 available operating options: Off, Antifreeze, Economy and Comfort).
 - d. Programming is completed when you exit the programming menu and reinitialize the radiator with the ON/OFF button (⏻).
 - e. Programmed settings are RECORDED in the radiator and remain STORED in it even if you unplug the unit or there is a power outage.

3. PROGRAMMING the Radiator:

- a. To enter the programming menu press the PROGRAMMING button (⊗).
 - b. The current day of the week will blink.
 - c. Choose the day that you wish to program using the UP and DOWN buttons (▲ ▼). Through these buttons you can choose the day of the week:
 - Monday, Tuesday, Wednesday, Thursday, Friday, Saturday or Sunday individually (un day at a time)
 - If you continue pressing the UP button (▲) after Sunday (SU,) ALL the days of the week will blink simultaneously. In this mode, the same programming will be applied to ALL the days of the week.
 - If you press the UP button (▲) again, ONLY working days —Monday (MO) to Friday (FR) — will blink. In this mode, the same programming will be applied to ALL the working days of the week.
 - If you press the UP button (▲) again, ONLY weekend days —Saturday (SA) and Sunday (SU) — will blink. In this mode, the same programming will be applied to BOTH weekend days.
 - d. After choosing a day or a range of days, confirm your selection by pressing the CONFIRM button (↵).
 - e. At this point, the first HOUR (1 □□) of the TIME WINDOW will start blinking. The first hour to blink will be hour 1, that is, from 00:00 to 01:00 (you are about to program the temperature from 12 midnight to 1 am).
 - f. Press the UP and DOWN buttons (▲ ▼) to choose the hour that you wish to program.
 - g. Once you have selected the hour that you wish to program, press the CONFIRM button (↵).
 - h. The display will then show the temperature (22°C). As you press the CONFIRM button (↵) repeatedly, the display will show the 4 adjustment choices:
 - Off: the temperature disappears from the display,
 - Antifreeze: the radiator shows 22°C and the display shows the antifreeze symbol ❄️
 - Economy: the radiator shows 22°C and the display shows the symbol ⌋
 - Comfort: the radiator shows 22°C and the display shows the symbol ⚙️
- The graph on the left-hand side of the display will show the following, depending on the programmed value chosen:
- Off: The display shows the hour and 8 □□.
 - Antifreeze: The display shows the hour and 9 □■.
 - Economy: The display shows the hour and 10 □■□.
 - Comfort: The display shows the hour and 11 ■■□.
- i. Once you have selected the desired operating temperature, you can move to the next hour to be programmed by pressing the UP and DOWN buttons (▲ ▼).
 - j. Repeat the above steps (f, g, h, i) until you have finished programming hours for that day.
 - k. To store the programmed settings and move onto the next day or range of days, press the PROGRAMMING button (⊗). The display will empty and the next day of the week will start blinking.
 - l. To program the new day repeat the above steps (f, g, h, i, j, k).

WARNING !!

Remember that during all those hours that have been programmed in OFF mode (8 □□) the radiator will stay off until the next hour that has been programmed differently (Antifreeze, Economy or Comfort) arrives.

- m. Once you have PROGRAMMED and STORED the desired settings, you can exit the Programming menu by pressing the ON/OFF button (⏻). The radiator will turn off.
- n. The next time that you press the ON/OFF button (⏻) the radiator will turn on and start working according to the programmed settings stored in memory. The display will show the following:
 - The day of the week (MO, TU, WE, TH, FR, SA, SU)
 - The ambient temperature (19.5)
 - The temperature (22°C) programmed for the current time (if there is one)
 - The current time (13:52)
 - The PROGRAMMED symbol (⌚) if the unit is operating in this mode
 - The relevant symbol (❄️, ⌋, ⚙️) corresponding to the chosen operating mode
 - The graph showing the programmed settings for each hour
- o. ADDITIONAL NOTE: The radiator operating temperature can be modified by the user at any time, using the UP and DOWN buttons (▲ ▼). These changes are only temporary and DO NOT MODIFY the programmed temperature. When the next programming point is reached, the programmed temperature for that hour will come into effect and the radiator will continue to work as programmed by the user.

4. RESETTING THE UNIT:

If you wish to erase all programmed settings from memory, press the ON/OFF button (⏻) and the PROGRAMMING button (⊗) simultaneously for 3 seconds. All data programmed in the radiator memory will be erased. This allows you to program new adjustments to suit your requirements. The programmed temperature will return to the factory default settings.



This symbol on the appliance or packaging means that, when you wish to discard the appliance, you should deliver it to a designated waste electrical and electronic equipment collection facility.

Please contact your local authorities or the shop where you bought the appliance for information about disposal of waste electrical and electronic equipment.

This way you will collaborate in proper waste management and protect the environment.



GUARANTEE CONDITIONS

For the guarantee to be valid it is absolutely essential to submit this document with the vendors' stamp and the invoice or sales receipt.

GUARANTEE CERTIFICATE

Técnicas Energéticas del Norte, S.A. guarantees the product indicated in this certificate against any manufacturing defect pursuant to the following terms:

- Ten years from date of purchase for the heating block (aluminium block and internal components).
 - Two years from date of purchase for electrical and electronic components and against rusting.
- This guarantee covers both materials and labour, as well as travel for authorised technical support personnel.

Should the holder of the guarantee observe any non-conformity during the guarantee term, they may require that the product be repaired or replaced with another product of identical characteristics and, should this not be feasible, that the price of the product be reimbursed.

For product servicing, users should call **+34 945 601796** and provide the details appearing on this guarantee and we will send an authorised technical support service engineer to repair the product. This guarantee does not cover faults due to improper or negligent use of the product, products that have been manipulated or repaired by unauthorised personnel, faults arising from a failure to maintain the product clean, force majeure causes or faults due to incorrect installation. The manufacturer declines any responsibility should safety warnings and mounting and operating instructions be ignored.

GUARANTEE

DATE

MODEL

VENDOR STAMP





c/ Santa Coloma, 3
01320 - OYON - (Álava)
Tel. 945 60 17 96
Fax 945 62 29 01
tecnor@tecnor.com