



CavSeal

Cavity closer system

Synseal window products for new build

CavSeal cavity close



CavSeal - the fast and effective solution for closing cavities in masonry walls

Synseal's CavSeal recycled PVCu cavity closer speeds up the build process and boosts productivity of window installers and bricklayers.

Suitable for large or small developments, CavSeal closes off cavities in masonry walls and features a universal click-fix system to securely fit the complete pre-glazed window after the wall is completed.

CavSeal's strong box construction clips together with robust corners to form a durable cavity closer unit. Once fitted the window is simply slotted into place using the secure click-fix frame snapper.

Made with 100% recycled PVCu, CavSeal greatly reduces your impact on the environment.

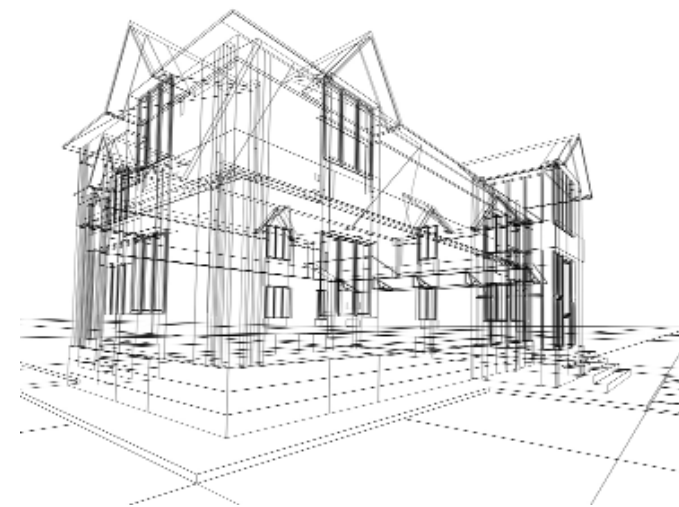

r system

- Fast clip together assembly.
- No adhesives required.
- Robust design.
- Fast and accurate installation.
- System is suitable for 50, 75 and 100mm cavities.
- Made with 100% recycled PVCu.
- Integral head vent option to meet building regulation requirements.
- Compatible with most window systems.
- Windows can be fitted from inside or outside the building.
- Helps to achieve compliance with HSE working at height guidelines.

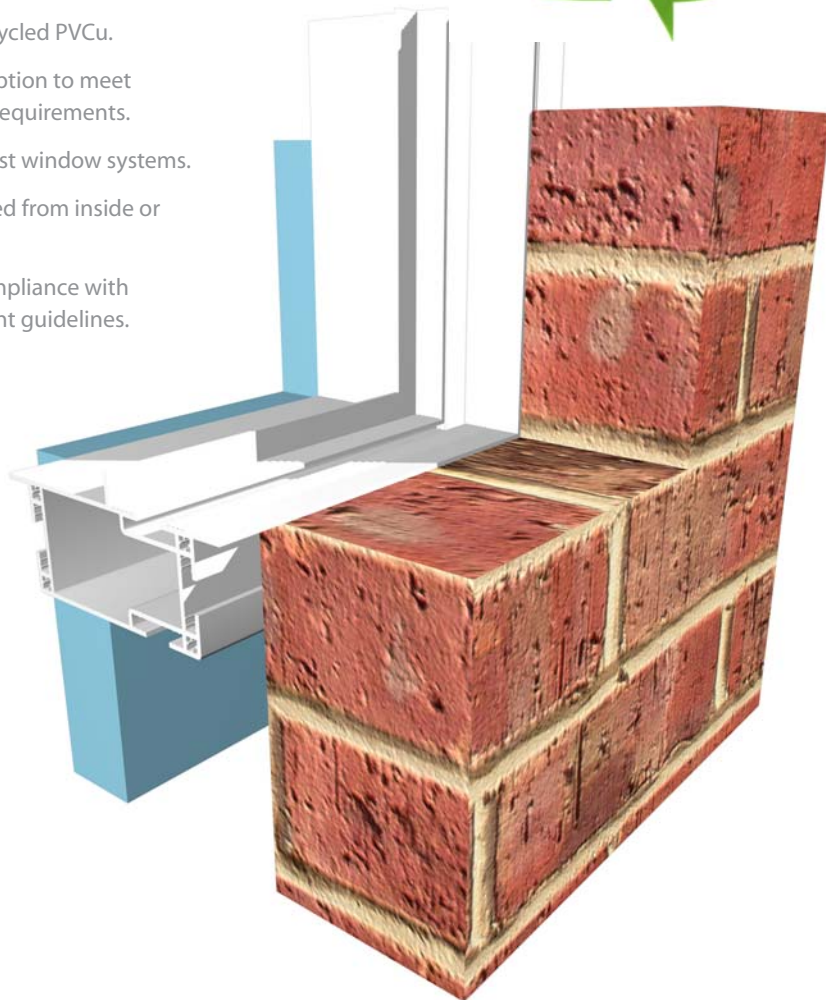

**CavSeal -
quick to make,
easy to fit and
easy on the
environment**



CavSeal is available in 3 widths, is fully recyclable and is easy to handle and install. Fabrication is simple with clip together corners and profile which is just square cut.

Please see the following pages for full product specifications and order codes.

CavSeal and its com

Trickle Vent

Slimline and standard sizes



Cavity Closer Extender

Corner Blocks

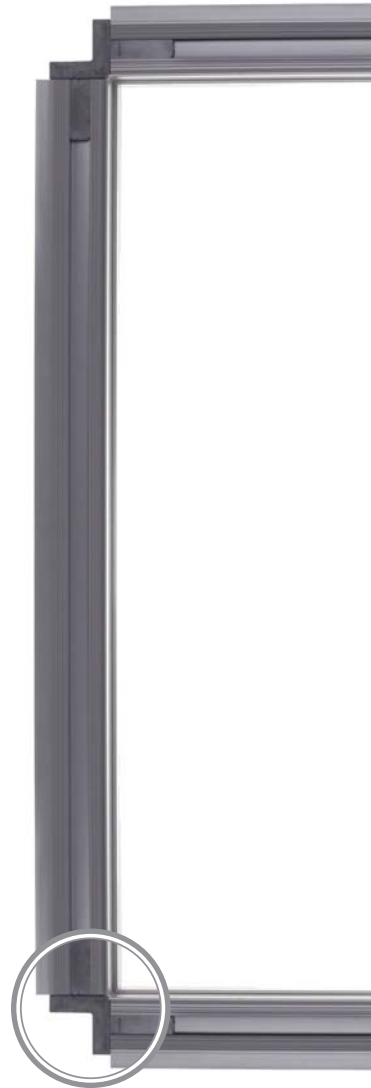
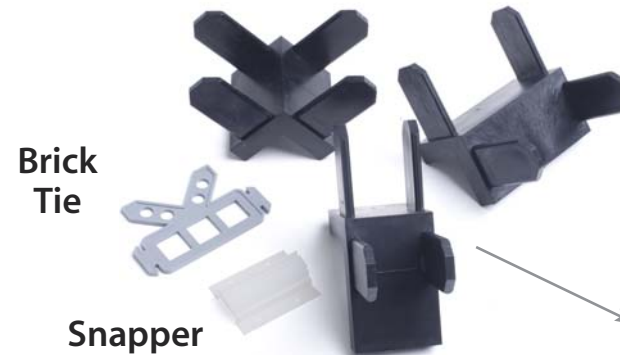



Head Vent

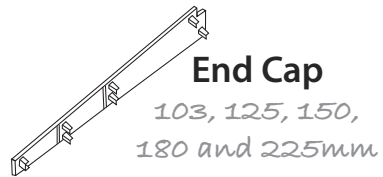

End Cap

103, 125, 150,
180 and 225mm

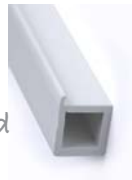

Sill Rebate Filler
Used if window board
not required

New Build Sill

103, 125, 150,
180 and 225mm

Steel



Window Board

175 or 225mm



take the environmental option

Envirosill is made from post consumer recycled windows with a skin of virgin PVCu applied to the seen faces to ensure aesthetics and performance are not compromised.

Envirosill minimises its impact on energy and resources, supports your environmental management and gives your customers an eco-friendly option to help minimise their carbon footprint.



ponents

CavSeal component

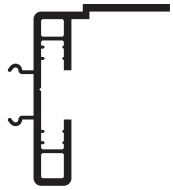

3CAV30
Cavity Closer Extender

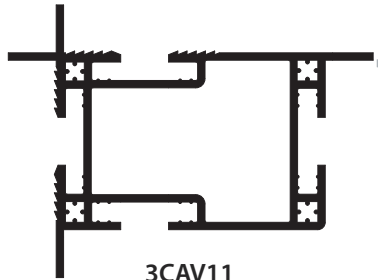

3CAV11
50/75mm Cavity Closer

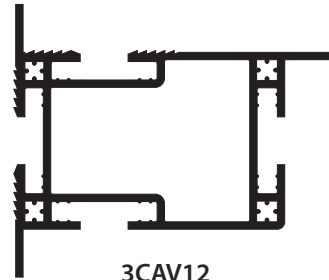

3CAV12
50/75mm Cavity Closer

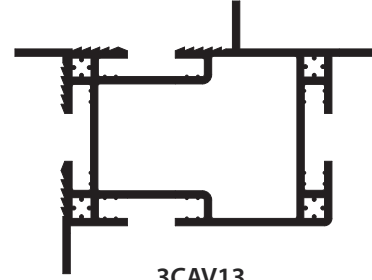

3CAV13
50/75mm Cavity Closer

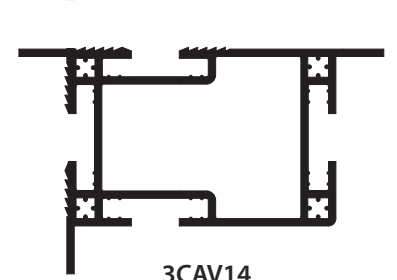

3CAV14
50/75mm Cavity Closer

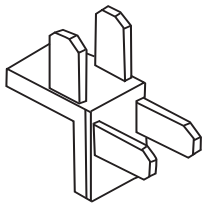

CAV3
50mm Corner Block

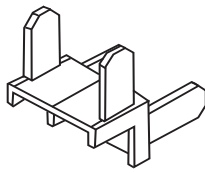

CAV4
75mm Corner Block

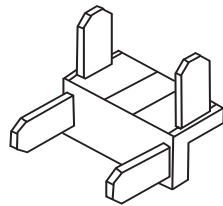

CAV5
100mm Corner Block

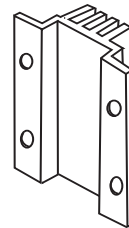

3SN1
Snapper

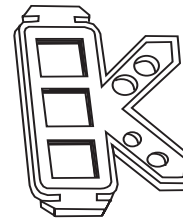

3BT1
Brick Tie

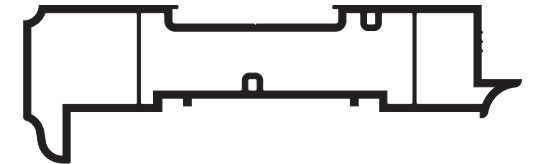

3HV1
Head Vent

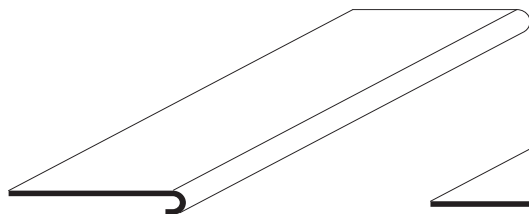

3WB-175
175mm Window Board

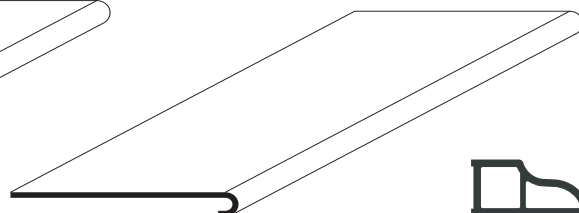

3WB-225
225mm Window Board



3AR1
Architrave 25mm x 12.5mm



3AR2
Architrave 46mm x 12.5mm



3SR1
Sill Rebate Filler



3S103
103mm Sill (G/Steel 3RS-V2)

s and product codes

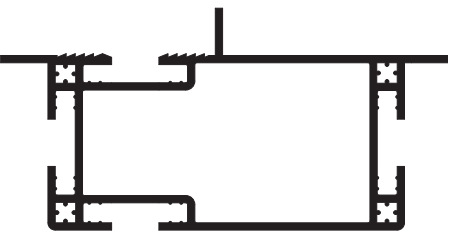

3CAV21
100mm Cavity Closer

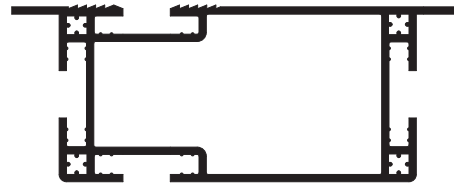

3CAV22
100mm Cavity Closer

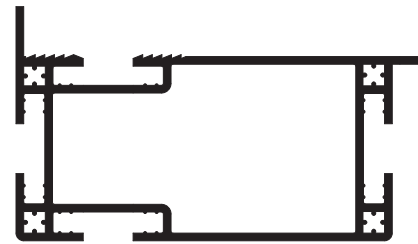

3CAV23
100mm Cavity Closer

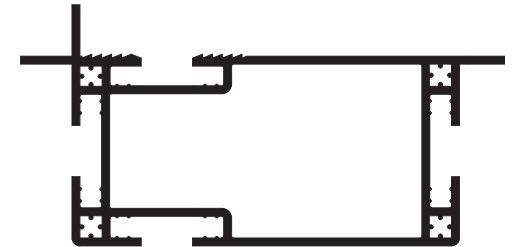

3CAV24
100mm Cavity Closer

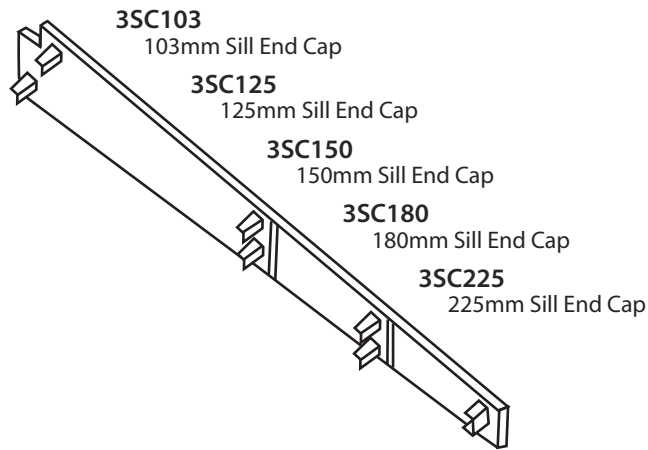

3S125
125mm Sill (G/Steel 3RS-V2)

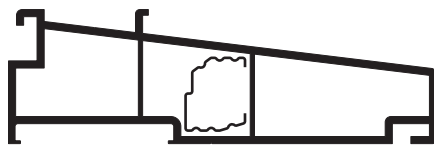

3S150
150mm Sill (G/Steel 3RS-V2)

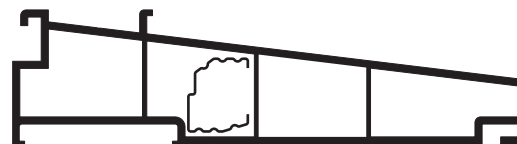

3S180
180mm Sill (G/Steel 3RS-V2)



3S225
225mm Sill (G/Steel 3RS-V2)

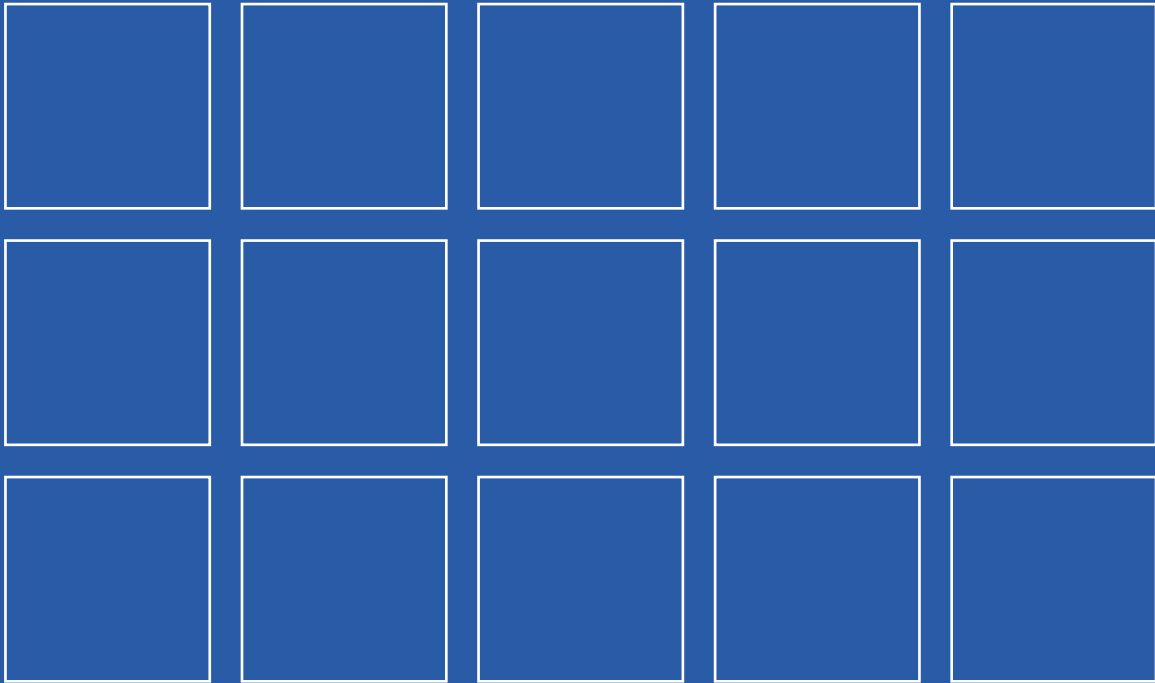

The UK's Number One Choice for
Windows, Doors & Conservatories

Tel: 01623 443200 www.synseal.co.uk