



# Choosing & using

## Customer Services

Tel 01283 722588 Fax 01283 722219

E-mail [info@marleyeternit.co.uk](mailto:info@marleyeternit.co.uk)

[www.marleyeternit.co.uk](http://www.marleyeternit.co.uk)

Marley Eternit Limited, Lichfield Road, Branston  
Burton on Trent DE 14 3HD



an etex company



# Introduction

## Why choose Marley Eternit fibre cement profiled sheeting?

- Only UK manufacturer of fibre cement
- Highly cost effective weatherproofing
- Low maintenance
- No rust, rot or corrosion
- Resistant to chemical attack
- Vapour permeability reduces condensation
- Excellent noise and thermal insulation
- Quick and easy to install and fix
- Wide product and colour range
- Unbeatable after sales service



## Contents

Introduction	2-3
Applications	4-5
Colour range	6-7
Profile 6 and Profile 3	8-9
Accessories	10-11
Product selector	12-13 (fold out)
Exposure	14-15
Installation	16-17
Ten easy steps to fixing	18-19
Working with fibre cement roofing sheets	20-21

The recommendations given in this leaflet are in accordance with BS 8219: 2001: Installation of sheet roof and wall coverings - Profiled fibre cement - Code of practice. For further information on fixing fibre cement sheets and fittings, refer to BS 8219 or contact Marley Eternit.

## Profile 3 and Profile 6

Marley Eternit, the UK's only manufacturer of fibre cement roofing and cladding solutions, has been producing profiled sheeting for over 90 years. Today, we offer two ranges of profiled sheeting – Profile 3 and Profile 6 – to a wide range of customers. The products are differentiated by the size of corrugation in the sheets; Profile 3 having smaller corrugations than Profile 6.

Both types of sheet are manufactured from a selected blend of Portland cement and water, reinforced with a mixture of both natural and synthetic fibres.

Marley Eternit have always worked to improve safety when using our range of roofing and cladding products. Building upon over 90 years experience in the UK roofing industry we have developed a purpose designed, reinforced fibre cement sheet – Profile 6 – that meets the high standards of safety in roofing work set out in the Health and Safety Executive document 'Health and Safety in Roof Work' (HSG 33). In addition to the Profile 6 sheet, we are proud to be able to offer a complementary range of accessories that meet the same high standards of safety.

Marley Eternit fibre cement profiled sheeting is manufactured in accordance with a quality system registered under BS EN ISO 9001. It also holds British Board of Agrément Certificate No. 00/3700.

## Which profile?

The decision to use Profile 3 or Profile 6 sheets will depend largely upon the following four criteria:

- 1 The scale of the building in question.
- 2 Compatibility with any existing materials.
- 3 The distance from centre to centre of the horizontal fixing rails or purlins.
- 4 Whether or not the roofing material is to be classified as non-fragile.

Reference should therefore be made to the sheet sizes, fixing details and product data provided in this leaflet before deciding which type of profiled sheeting to use.

Commercial



Residential



Industrial



Agricultural



Equestrian



Refurbishment



Leisure



# Colour ranges

## Painted colour range

Experience gained over many years has shown that the standard Marley Eternit colour range will meet the majority of design requirements in both rural and urban areas. All the standard colours have been chosen for their ability to harmonise with the most commonly used building materials – brick, slate, stone, concrete and timber.

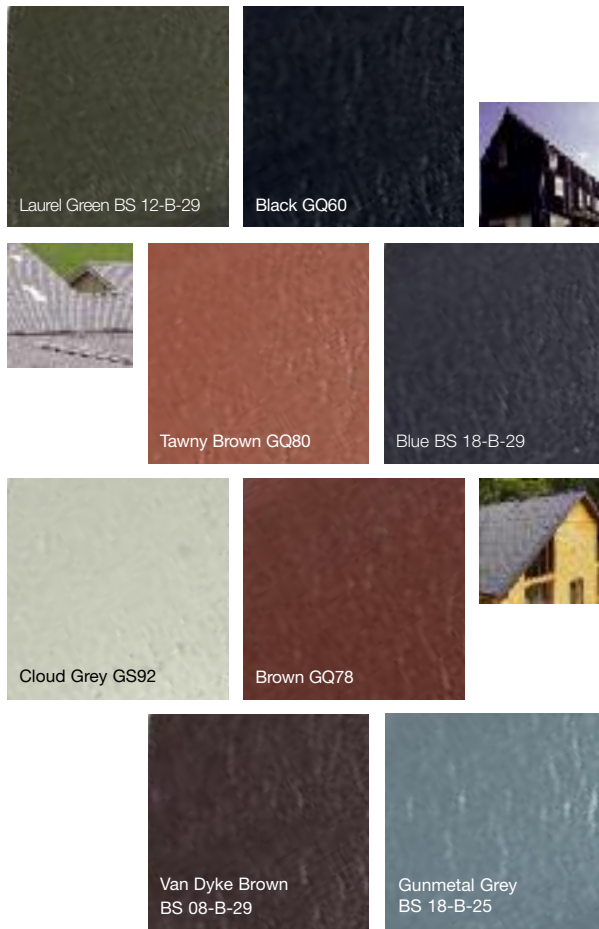

## Farmscape colour range

The farmscape range consists of three carefully chosen matt colours, namely: Anthracite (grey), Sherwood (green) and Bracken (brown). Together with the subtle variations in tone inherent in any natural cementitious product, the appearance of these colours will blend with almost any landscape from the day the building is erected.

Anthracite sheets have a pigmented surface coating and are available in a limited range of sheet sizes and fittings. The Sherwood and Bracken sheets have a spray-applied finish and are available in the full range of sheet sizes and fittings.

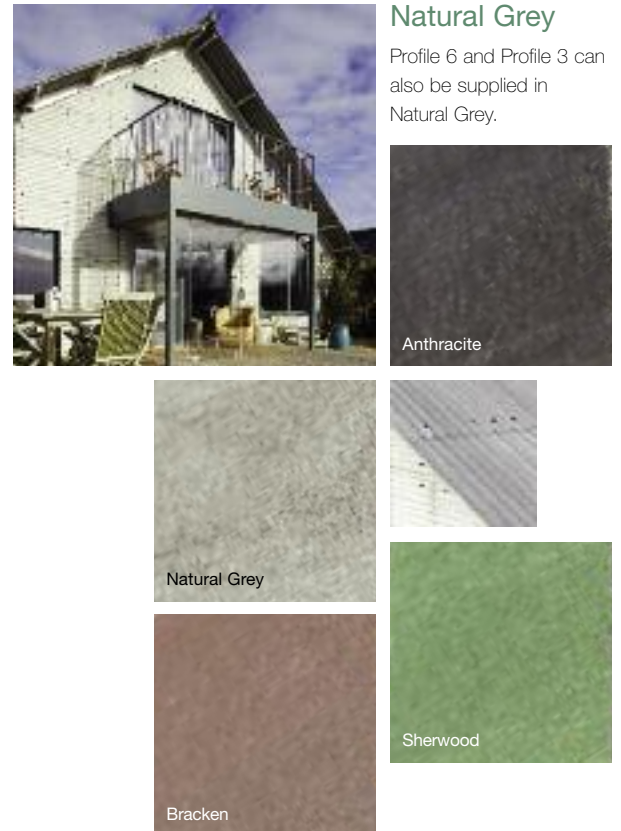

## Natural Grey

Profile 6 and Profile 3 can also be supplied in Natural Grey.

# Profile 6

## Profile 6 and safety in roof work

When correctly installed, Profile 6 has been tested and classified as non-fragile, and must be considered when working to the roof safety requirements of HSG 33.

Profile 6 is a high strength fibre cement sheet with polypropylene reinforcement strips inserted along precisely engineered locations which run for the full length of the sheet in each corrugation. This provides maximum reinforcement strength with no loss of durability in service.

### Profile 6 sheet lengths (mm)

1220, 1375, 1525, 1675, 1825, 1975, 2125, 2275, 2440, 2600, 2750, 2900, 3050.

### Farmscape lengths (mm)

1525, 1675, 2440, 2750, 2900, 3050.

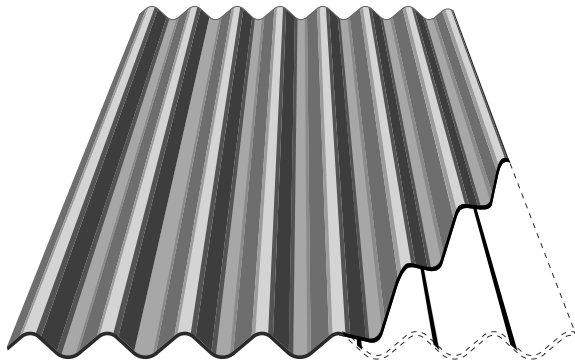

The cut-away illustration above shows the location of the polypropylene reinforcement strip inserted in a precisely engineered position in each corrugation of the Profile 6 sheet.

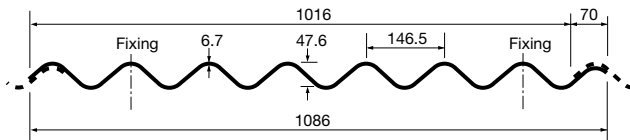

## Other products

In order to ensure full compliance with HSG 33, ridges and rooflights must also be upgraded. Marley Eternit can supply a full range of fittings to ensure that the complete roof is non-fragile – see pages 8 to 11 for details.

# Profile 3

## Profile 3

The lower profile of this product makes it particularly suitable for a range of domestic, agricultural and light industrial buildings. It can be laid to a minimum roof pitch of 10°.

### Profile 3 sheet lengths (mm)

1525, 2450, 3050

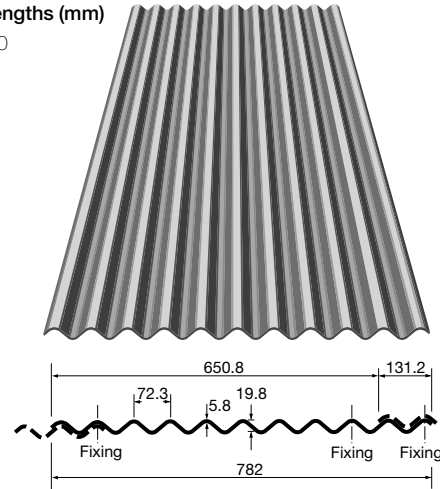

Technical data	Profile 6	Profile 3
Overall width	1086mm	782mm
Net covering width	1016mm	650.8mm
Thickness (nominal)	6.7mm	5.8mm
Density (nominal)	1450kg/m <sup>3</sup>	1450kg/m <sup>3</sup>
Pitch of corrugations (nominal)	146.5mm	72.3mm
Depth of profile	47.6mm	19.8mm
Profile height category	C	A
Side lap	70mm	131.2mm
Minimum end lap	150mm	150mm
Maximum purlin centres	1375mm	925mm
Maximum rail centres	1825mm	1225mm
Maximum unsupported overhang	350mm	250mm
Approx. weight of roof as laid, with 150mm end laps, single skin including fixings	17kg/m <sup>2</sup>	14.5kg/m <sup>2</sup>
Minimum roof pitch	5°	10°

# Accessories

	Profile 3	Profile 6
Cranked crown sheet	N/A	Girth: 750 or 900mm Sizes: 5°, 7.5°, 10°, 12.5°, 15°, 17.5°, 20°, 22.5°
Ventilating crank crown	N/A	Girth: 750mm Sizes: 5°, 7.5°, 10°, 12.5°, 15°, 17.5°, 20°, 22.5°
Two piece close fitting ridge	Cover width: 650.8mm (adjustable)	Cover width: 1016mm (adjustable)
Two piece ventilating ridge	Cover width: 650.8mm (adjustable)	Cover width: 1016mm (adjustable)
Two piece plain wing ridge	Cover width: 650.8mm (adjustable)	Cover width: 1016mm (adjustable)
Hooded two piece ridge finial	N/A	Available

Note: Cover widths indicated make allowance for overlap

# Product selector

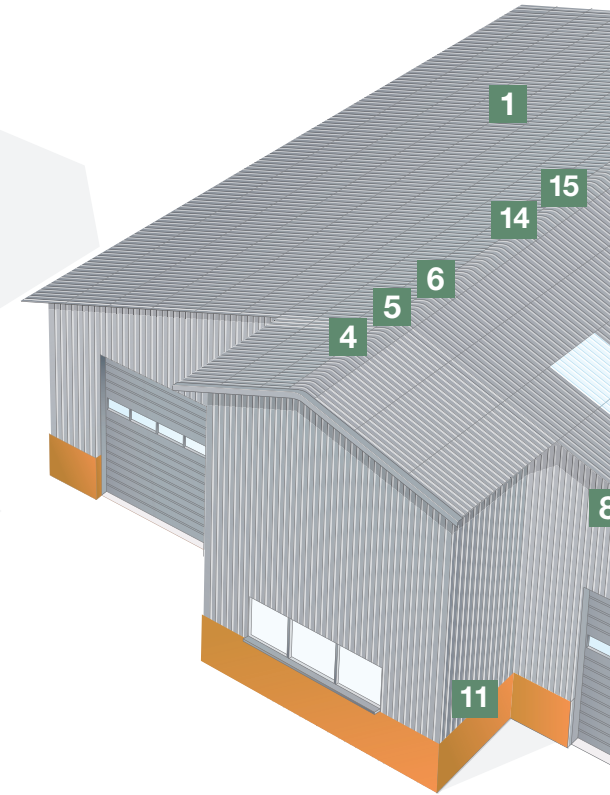
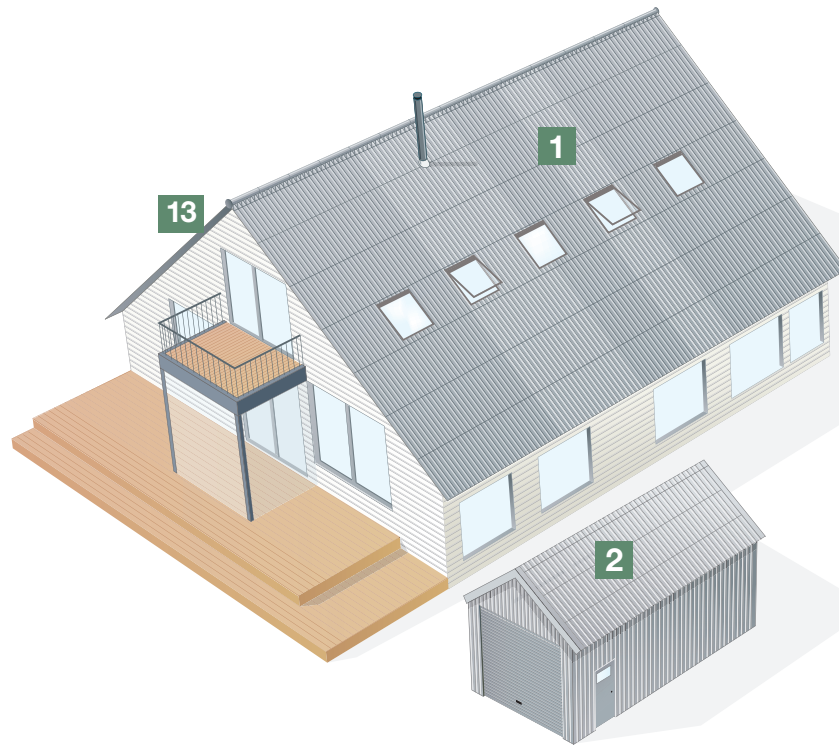

**1** Profile 6

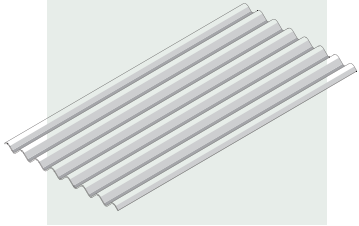

**2** Profile 3

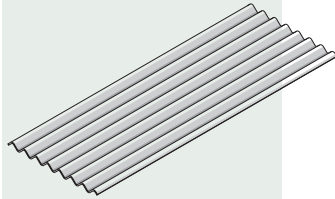

**3** GRP translucent sheet

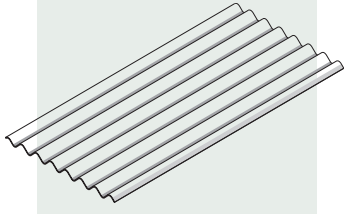

**4** Two-piece plain wing ridge cover  
Adjustable over range of roof pitches.

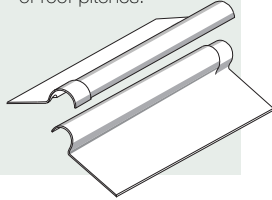

**5** Cranked crown sheet  
For covering apex of roof.

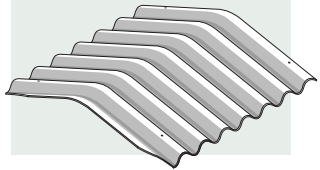

**6** Ventilating cranked crown  
For ventilation at apex of roof.

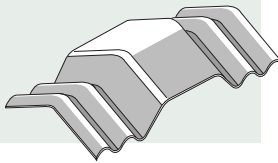

**9** External corner  
Plain wing cover trim for wall-to-wall and roof to gable end wall.

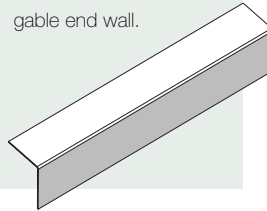

**10** Eaves corrugation closer  
For blanking off corrugation voids at eaves of roof.

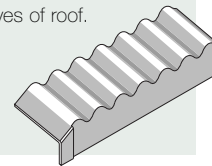

**7** Apron flashing  
For weathering top of mono-pitch lean-to roofs.

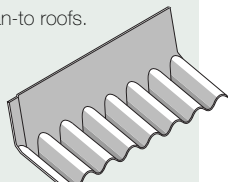

**8** Roll top bargeboard  
Decorative trim for corner junction of roof and gable end wall.

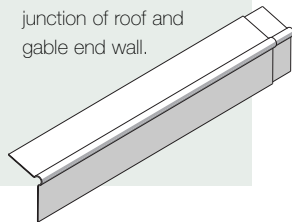

**11** Horizontal flashing piece  
Used at junction of vertical sheeting above a wall or at a designed interruption of sheeting

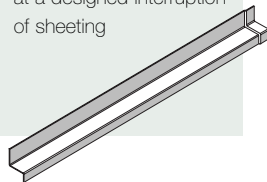

**12** Eaves filler  
For blocking corrugation voids at eaves of roof.

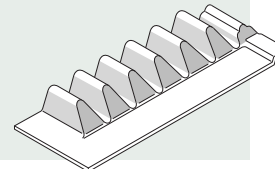

**13** Hooded two piece ridge finial  
Made to suit roll top bargeboards with two-piece adjustable ridge only. Profile 6R only.

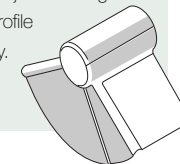

**14** Two piece ventilating ridge cover  
Adjustable over range of roof pitches providing natural ventilation.

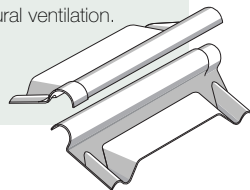



# Exposure

When using profiled sheeting the windloadings of a location are critical to ensure the optimal sealing requirements.

## Exposure zones

Approximate wind driven rain (litres/m<sup>2</sup> per spell)

-  less than 56.5
-  equal to or greater than 56.5
-  contact Technical Department

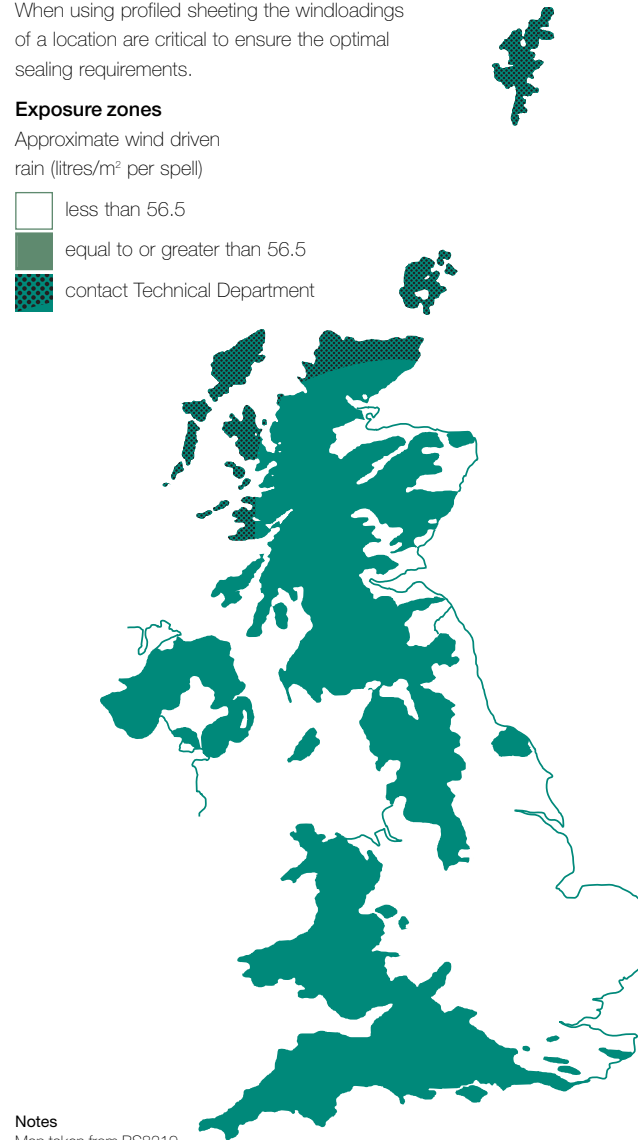

### Notes

Map taken from BS8219.

When buildings stand above their surroundings or are situated in open country with no windbreaks, including sites on or near the coast, or on hill tops, they must be considered subject to severe exposure.

## Lap

This describes how much one sheet overlaps another at either the end (end lap) or the side (side lap).

## Pitch

This describes the degree to which the roof slopes.

## Guidance procedure

### Step 1: Exposure

Determine the expected degree of exposure by examining the adjacent map.

### Step 2: Centres of support

Purlin centres for Profile 6 should be a maximum of 1375mm for a superimposed loading up to 1.89kN/m<sup>2</sup>. For Profile 3, the purlins should be at 925mm maximum centres for loadings up to 1.8kN/m<sup>2</sup>. There should be two fixings per sheet, per purlin. Where windloadings exceed this level, please contact the Marley Eternit Technical Department for advice before proceeding.

### Step 3: Lap and seal

Establish requirement for lapping and sealing by reference to the exposure zones map of the UK and the table below. See page 13 for sealing details.

### Step 4: Fixings

## Sheltered and moderate sites

### Less than 56.5 l/m<sup>2</sup> wind driven rain per spell

Minimum Roof pitch	End lap (mm)	Lap treatment	
		End laps	Side laps
22.5° and over	150	Unsealed	Unsealed
15° and over	300	Unsealed	Unsealed
15° and over	150	Sealed	Unsealed
10° and over	150	Sealed	Sealed

## Moderate and severe sites

### More than 56.5 l/m<sup>2</sup> wind driven rain per spell

Minimum Roof pitch	End lap (mm)	Lap treatment	
		End laps	Side laps
25° and over	150	Unsealed	Unsealed
17.5° and over	150	Sealed	Unsealed
15° and over	150	Sealed	Sealed
10° and over	300	Sealed	Sealed

### Note

On roofs over 10° pitch where parapets might allow snow build up, 300mm double sealed end laps and single seal side laps are recommended. The minimum pitch for Profile 6 is 5°. Where slopes are between 5° and 10° the maximum slope length should be 15m with double sealed end laps and single sealed side laps.

	Profile 3	Profile 6
Eaves corrugation closure	Cover width: 650.8mm Size: 75mm (effective leg length) Handed left and right	Cover width: 1016mm Sizes: 65, 100, 150, 250mm (effective leg length) Universal
Eaves filler	Cover width: 650.8mm Handed left and right	Cover width: 1016mm Universal
Apron flashing	Cover width: 650.8mm Size: 120° Handed right	Cover width: 1016mm Size: 124° Handed left
Roll top barge board		Overall lengths: 1525mm, 2440mm, 3000mm Available in 200 x 200mm and 300 x 300mm wing dimensions
External corner		Overall lengths: 1800mm, 2440mm, 3000mm Available in 200 x 200mm and 300 x 300mm wing dimensions
Horizontal flashing piece		Overall lengths: 2080mm (2032mm cover) 75mm projection for single cladding 140mm projection for double cladding

# Installation

**Whilst Marley Eternit profiled sheeting is easy to install, the following guidelines should be observed:**

- The sheets should be installed smooth surface up.
- The sheets should be cut with a hand saw or slow speed reciprocating power saw.
- All fixing holes should be drilled, not punched, and should provide adequate clearance for the fastener shank (minimum 2mm).
- There should be two fixings per purlin or rail covered at the fixing points shown on pages 8 and 9.
- When using power tools in a confined area, dust extraction equipment is advisable.
- The dust and swarf generated when working with the sheets does not require any special handling requirements other than normal good housekeeping to maintain a clean working area.

## Fixing

The correct fixing of a sheet is important in order to avoid premature failure, corrosion or leaks in a roof. Many factors influence the fixing of a roof, such as the purlin or rail type and the nature of the roof in question. Particularly important is the type of fastening system used and compliance with the manufacturer's recommendations.

Topfix fasteners are generally used to fix Profile 6 sheets on a roof as they provide a quick and effective one step fixing operation. Follow the recommendations of the fastener manufacturer regarding maximum roof pitch, minimum purlin thickness etc. Topfix fasteners should be installed using the recommended depth setting power tool to ensure the fasteners are correctly tightened.

### Checking the topfix fasteners for tightness

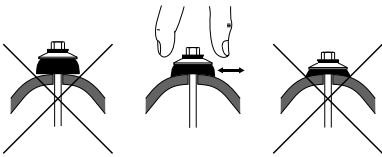

Where topfix fasteners are not used, 8mm diameter fasteners are used for Profile 6 and 6mm diameter for Profile 3. The fibre cement sheet must be pre-drilled with a 2mm clearance hole. If using drive screws, the holes must be located centrally on the purlins, if using hook or crook bolts, the holes should be 4mm upslope of the from the back edge of the purlin. In all instances, Sela washers and caps should be utilised to ensure adequate weather protection.

## Overhangs

Sufficient overhangs must be allowed at the eaves to ensure that rainwater discharges into the gutter. Verges must be overhung by one complete corrugation unless a bargeboard is used.

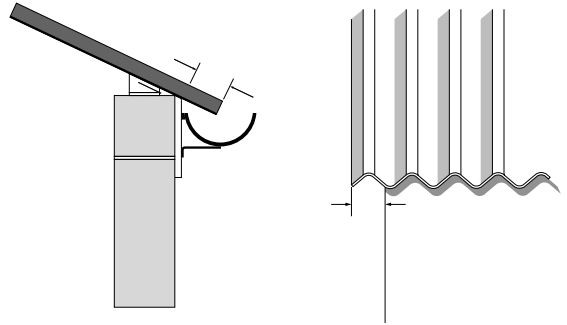

## Side Laps

### Sealing

Where appropriate, butyl strip sealant should be positioned as shown. Use 8mm diameter butyl strip for Profile 6 and 6mm butyl strip for Profile 3.

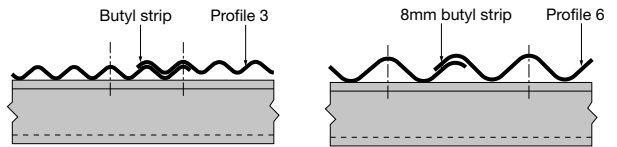

## End Laps

The minimum end lap for either Profile 3 or Profile 6 is 150mm, fixed as shown in the section below.

Where double sealing is necessary, with 300mm endlaps, the second butyl strip should be positioned 100-200mm below the fixing.

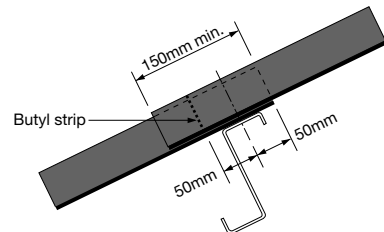



# Ten easy steps to fixing

The fixing of a fibre cement roof can be accomplished by most people if they follow these ten easy steps in conjunction with the illustrations opposite. In order to weatherproof the roof, the butyl strip must be installed as described on page 13, and mitres cut to avoid having four thicknesses of sheeting in the same plane at the junctions of sides and end laps.

- 1 Lay sheet number 1 at the eaves without mitring.
- 2 Lay sheet number 2, mitring bottom right hand corner as per the illustration opposite.
- 3 Lay sheet number 3, mitring as per step 2. Continue up the roof slope to complete the first tier.
- 4 Lay sheet number 4 at the eaves of the next tier, mitring the top left hand corner as per the illustration opposite.
- 5 Lay sheet number 5, mitring both top left hand and bottom right hand corners as per illustration opposite, and continue up the slope until ready to lay sheet number 6 at the ridge.
- 6 Lay sheet number 6 at the ridge, mitred as per step 2.
- 7 Repeat the procedure from and including step 4, working across the roof from eaves to ridge, until there is room for only one more tier to be laid, on the right hand edge.
- 8 Lay sheet number 7, mitring the top left hand corner. If necessary, reducing the sheet width by cutting down the right hand edge. All subsequent sheets in this final tier should be cut accordingly.
- 9 Lay sheet number 8 as per step 7, continuing up the roof slope until ready to lay the final sheet at the ridge.
- 10 Lay sheet number 9 at the ridge without mitring to complete the roof.

## Notes

- 1 On a duo pitch roof start both slopes from the same end of the building. One slope will therefore be sheathed left to right, the opposite slope will be sheathed right to left.
- 2 The corrugations of sheets must line up at the apex to ensure that the ridge accessories will fit.
- 3 When cranked crown sheets are used, both top courses of roofing sheets and the cranked crowns themselves must be mitred.
- 4 Always lay sheets with the correct end and side laps, as detailed elsewhere in this booklet.
- 5 Do not cut mitres in situ.

## Mitring plan single slope roof

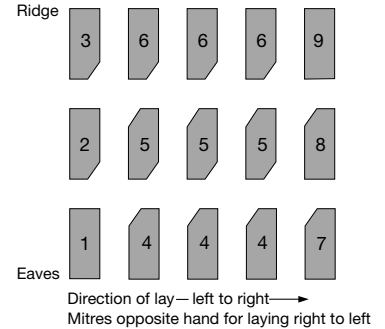

## Mitring Profile 3\*

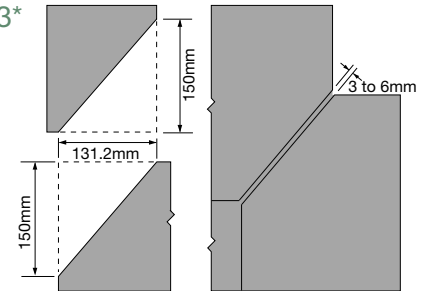

## Mitring Profile 6\*

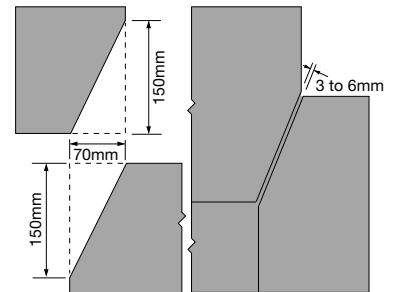

\* Assumes 150mm end lap

# Working with Marley Eternit fibre cement roofing sheets

## Storage and handling

### Storage (general)

Profiled sheets should be stored as close as practically possible to the area of works, on a firm level base, using the profiled bearers (on which the sheets are delivered) to raise the sheets off the ground. Sheeting stacks should generally not exceed 1200mm high unless a level concrete base is available, in which case, the maximum height is 1500mm. A separate stack should be made of each length of sheet; if this is not possible, stack with longest sheets at the bottom and the shortest at the top. It is important when stacking Profile 6 sheets on site that the smaller 'under rolls' are all on the same side of the stack. Sheets should always be stored weather (smooth) side upwards.

Stacks of sheets should not be stored in full sun during the summer months as the differential temperature across the sheets can result in unacceptable stresses in the sheets and can lead to edge cracking.

If sheets are to be retained in the packs for more than 3 months, they should be stored inside a building where they can be protected from extreme variations in temperature and moisture.

Ingress of moisture into packs of profiled sheets may cause efflorescence staining, bowing during installation or permanent distortion.

### Storage (natural grey sheets)

The plastic wrapping should be retained for as long as possible to control the environment around the sheets. Once the pack has been opened, or if the wrapping is damaged and allowing the ingress of water, the sheets should be stored under cover.

### Storage (coloured sheets)

Coloured sheets should be stored under cover at all times, preferably inside a building, but if this is not available they can be stored under a tarpaulin. The tarpaulin should be spaced off the top and sides of the sheets to allow effective air circulation and avoid condensation.

The plastic wrapping on coloured sheets is only designed to protect the sheets in transit. It should be removed and carefully disposed of as soon as possible.

## Safety

- The structure should be adequately prepared for the sheets.
- The position and fixing of all purlins should be checked before starting sheeting. Ensure the purlin system is adequately braced in accordance with the manufacturer's recommendations.
- Ensure there is proper access to the roof.
- Workmen should not work directly beneath the area being sheeted.
- Provide a scraper at the bottom of all ladders to remove mud from boots.
- Sheeters should wear suitable clothing: Wear boots or shoes (not Wellington boots), avoid loose, flapping clothing, avoid trousers with turn-ups.
- Treat as a fragile roof and always use crawling boards, roof ladders or walkways.
- Workmen should not be allowed to use the roof as a working platform during sheeting.
- Materials should not be stacked on the roof.
- It is possible for one man to safely handle smaller sheets at roof level on a calm day. However, safe handling of profiled sheets on a roof may require two men in certain circumstances.
- Two men are always required to lay the eaves course and the sheets above rooflights.
- Always lay the sheets in accordance with the approved sequence.
- Do not cut the sheets in a confined space since nuisance dust will be created.
- Remove all loose material from the roof as the work proceeds.
- Always fully fix the sheets as the work proceeds.
- Do not leave tools on the roof surface.
- Avoid deflecting a sheet whilst attempting to force a bearing.
- Sheets should be laid in tiers from the eaves to the ridge, thereby allowing easier use of crawling boards.
- Correct staging should always be laid over the purlins ahead of the sheeting.
- Where regular access is required to reach roof lights, ventilation and service ducts, properly constructed walkways should be provided.
- Take extra care on a roof during windy, wet or frosty weather.
- Take extra care on painted sheets whose surface will be more slippery than natural grey sheets.
- Do not step on sheets.

**In addition to the Construction (Design and Management) Regulations 1994 (CDM), always observe the relevant provisions of the Health and Safety at Work legislation currently in force.**