



Roofing Sheet & Wall Cladding Specialists

©Copyright Rhino Steel Cladding
No reproduction of these images is permitted
without written permission from Rhino Steel Cladding

©Copyright Rhino Steel Cladding
No reproduction of these images is permitted
without written permission from Rhino Steel Cladding

About Us

Rhino Steel Cladding is a family run business based in the West Midlands specialising in all types of profiled steel roofing sheets and wall cladding sheets.

With over 30 years of experience we manufacture a wide range of quality products to suit all needs, including box profile sheets, corrugated sheets, tile effect sheets, anti-condensation sheets, flat sheets, GRP rooflights, Z – purlins, C – section purlins, industrial guttering and all fixings and flashings to match. These products are suitable for many applications, from agricultural and industrial buildings, to domestic use for garages, lean-to's and workshops.

When ordering from Rhino Steel Cladding you can be assured of quality products at extremely competitive prices, excellent after sales and a reliable delivery service throughout the whole of the UK.

We are situated on a large industrial site with excellent loading facilities and ample space for heavy goods vehicles to manoeuvre.

Whatever your requirements, our dedicated team of sales advisors will endeavour to assist with your enquiry and will advise you on any products and prices which are not displayed in the brochure.

Products

Roofing Sheets and Wall Cladding Sheets

Rhino Steel Cladding roofing sheets and wall cladding sheets are manufactured and cut to size. All our sheets provide 1m cover width when fitted (*unless otherwise advised*).







Each profile is available in various colours and finishes with matching flashings and colour coded fixings.

We supply GRP fibreglass rooflights to match all our steel profiles, these allow natural daylight into the building. We can even supply obsolete profiles to replace old brittle rooflights and porous fibre cement sheets.

We also manufacture anti-condensation sheeting to reduce the inherent condensation problems associated with single skin non-insulated, agricultural and light industrial buildings.

Key

Our standard colours are shown below, however, many other colours are available on request.

	Juniper Green		Goosewing Grey
	Olive Green		Anthracite
	Slate Blue/Grey		Black
	Merlin Grey		Van Dyke Brown
	Grey Alkyd		Terracotta

Colour Accuracy: Colours are for guidance only. We have made every effort to match the colours above however; we cannot guarantee an exact colour match. Please request a sample for an exact colour match.

Finishes: Available in three styles:

 **Standard uncoated galvanised**
Pure galvanised uncoated steel.

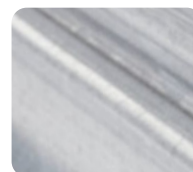

 **Polyester Smooth Painted Finish**
Galvanised steel with a polyester smooth painted finish. This finish has a moderate resistance to scratching with a life expectancy of 25 years in normal environments.



 **Plastisol/Plastic Vinyl Coated (PVC) Finish**
Galvanised steel with a plastic vinyl coating (PVC). These sheets have a lightly textured surface, such as a leather grain or scintilla golf ball effect. This finish has a high resistance to scratching and damage with a life expectancy of 30 years in normal environments.

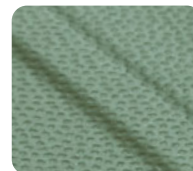
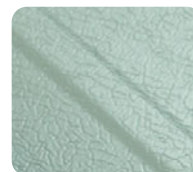

 **Anti-Condensation Sheeting:** Available in this profile

 **Rooflights:** Available in this profile

©Copyright Rhino Steel Cladding
 No reproduction of these images is permitted
 without written permission from Rhino Steel Cladding

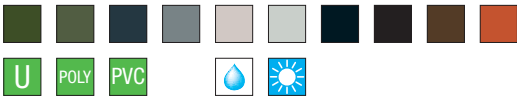
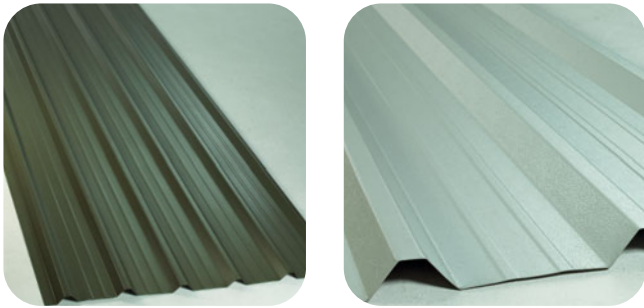
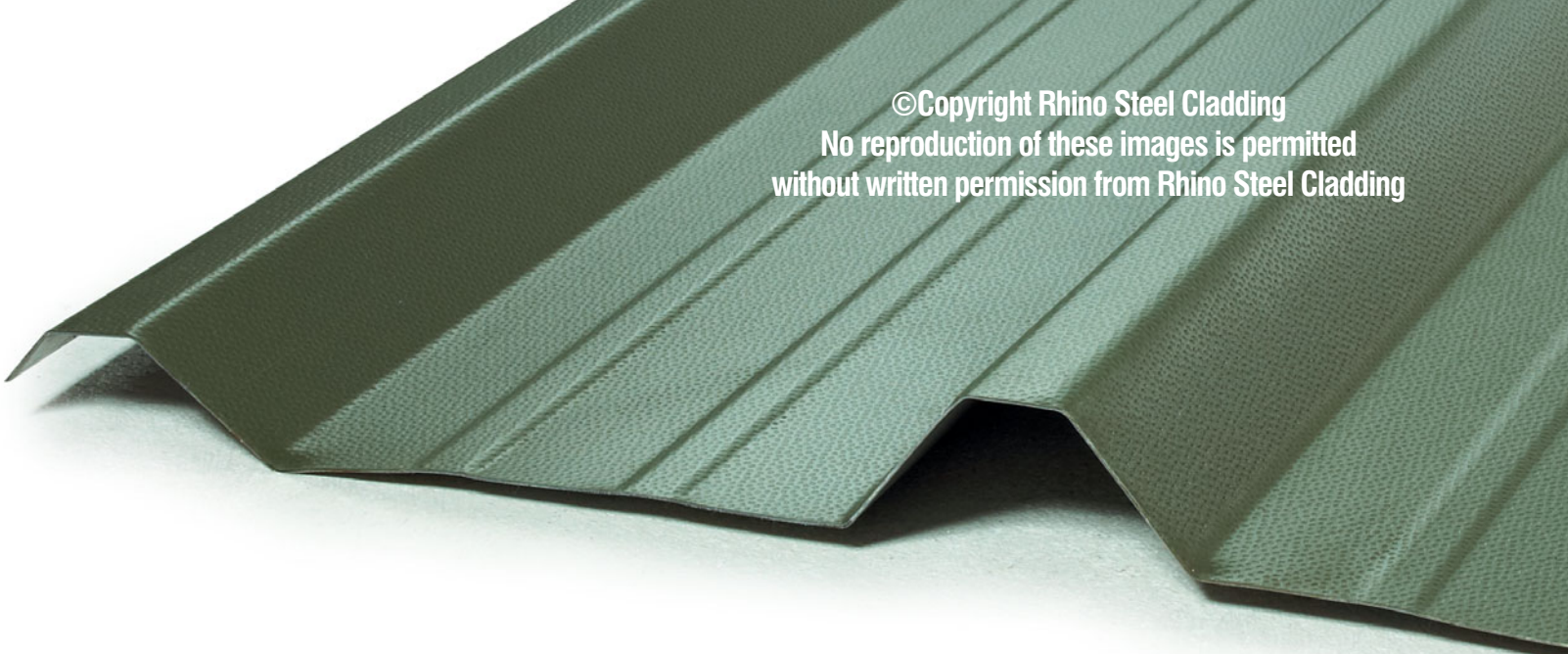

Box Profile 32/1000

Our galvanised steel box profile roofing sheets and wall cladding sheets consist of six profiles and five valleys where the water runs. For extra support and stability, two extra swages are rolled into every valley of the sheet.

Each profile is 32mm deep and at 200mm centres from peak to peak.

They are available in two gauges; 0.5mm and 0.7mm with three different finishes.

Tip! When fixing timber batons or steel purlins in preparation for our box profile 0.5mm gauge sheets, we recommend that you use centres of no greater than 1200mm and for 0.7mm gauge sheets no greater than 1800mm.

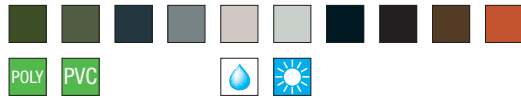
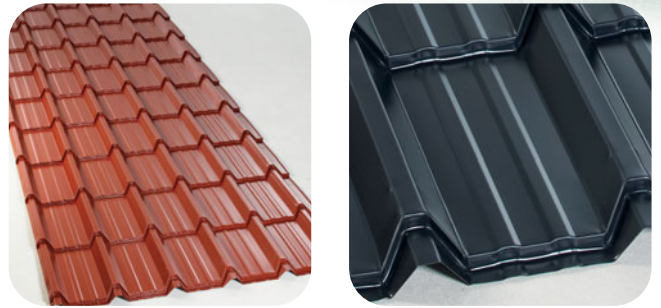

Tile Effect 32/1000

Our galvanised steel tile effect roofing sheets offer a lightweight, cost effective, easy to fit alternative to traditional roofing slate or clay tiles.

Each profile is 32mm deep. Each sheet is 0.55mm gauge. Each individual tile is 300mm long by 200mm wide, providing 5 tiles across the width of each sheet. (eg. a 3 metre long sheet will consist of 50 tiles on a sheet).

All standard colours are available with two different finishes. The most popular being Terracotta to resemble the traditional clay tiles and Slate Blue/Grey to resemble the traditional slate tiles.

Tip! When fixing timber batons or steel purlins in preparation for our tile effect sheets, we recommend that you use centres of 300mm, 600mm or 900mm.

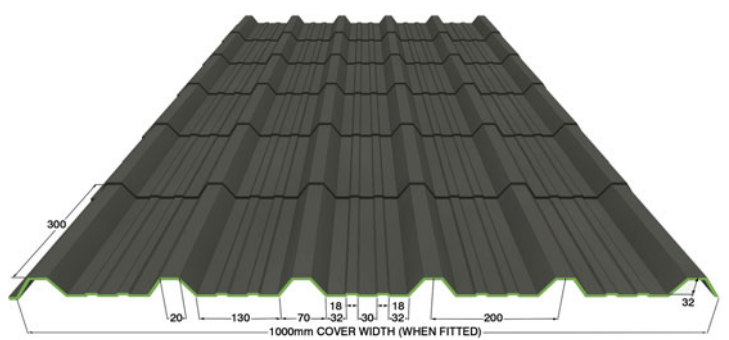
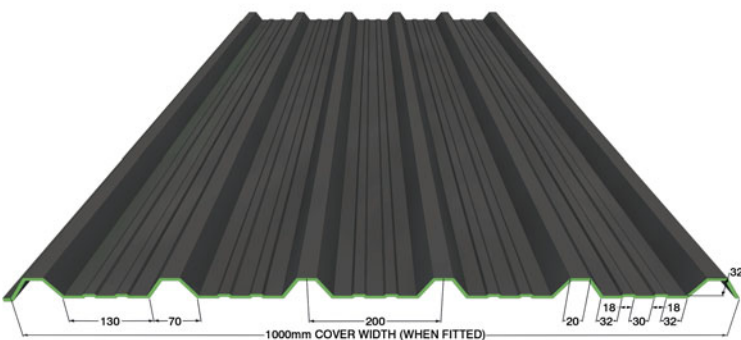

©Copyright Rhino Steel Cladding
 No reproduction of these images is permitted
 without written permission from Rhino Steel Cladding

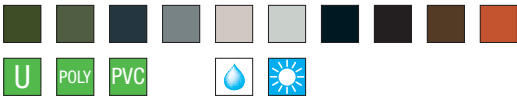
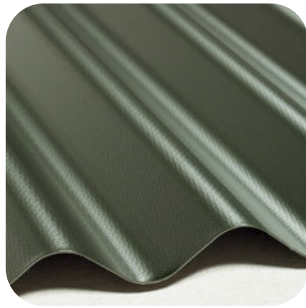

Traditional Corrugated

Our traditional galvanised steel corrugated roofing sheets have 3 inch (76.2mm) profiles from peak to peak. They are available in two gauges; 0.5mm and 0.7mm with three different finishes.

Tip! When fixing timber batons or steel purlins in preparation for our corrugated 0.5mm gauge sheets, we recommend that you use centres of no greater than 1200mm and for 0.7mm gauge sheets no greater than 1800mm.

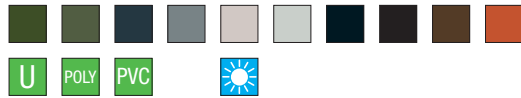
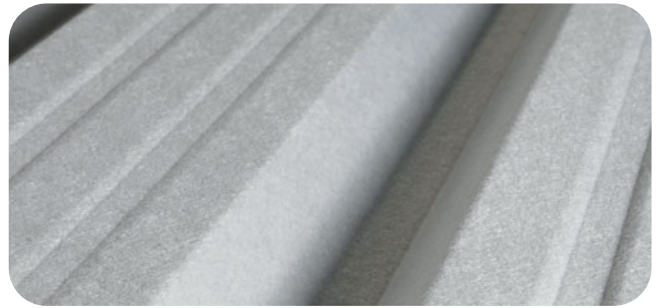
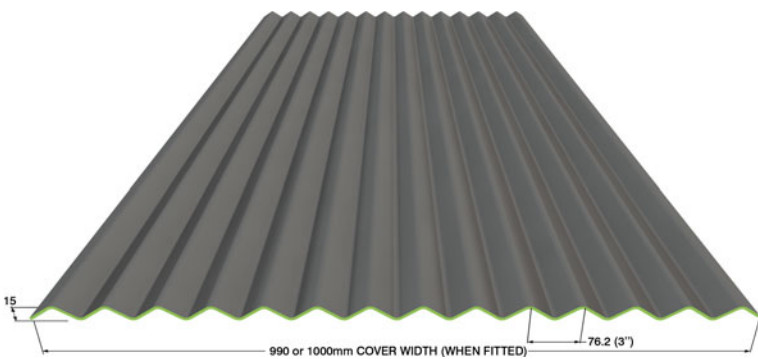

Anti-Condensation Non-Drip Roofing Sheets

Rhino Steel Cladding anti-condensation sheeting has been developed to reduce the inherent condensation problems associated with single skin non-insulated, agricultural and light industrial buildings.

The product is manufactured by bonding a non-woven polyester membrane to the reverse side of the sheet. The membrane works by absorbing the formed droplets and retains them until the temperature rises and moisture dissipates naturally. These sheets also have improved noise reduction from rainfall due to the cushioning effect.

Our anti-condensation roofing sheets are available in three profiles; box profile, tile effect and corrugated with a choice of three different finishes.

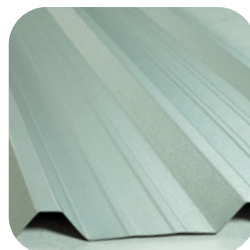

Note!
 It is essential that sufficient ventilation is provided to allow the membrane to work properly.

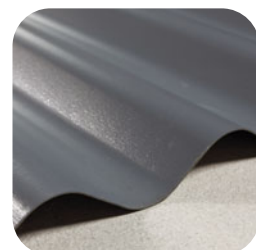

©Copyright Rhino Steel Cladding
No reproduction of these images is permitted
without written permission from Rhino Steel Cladding

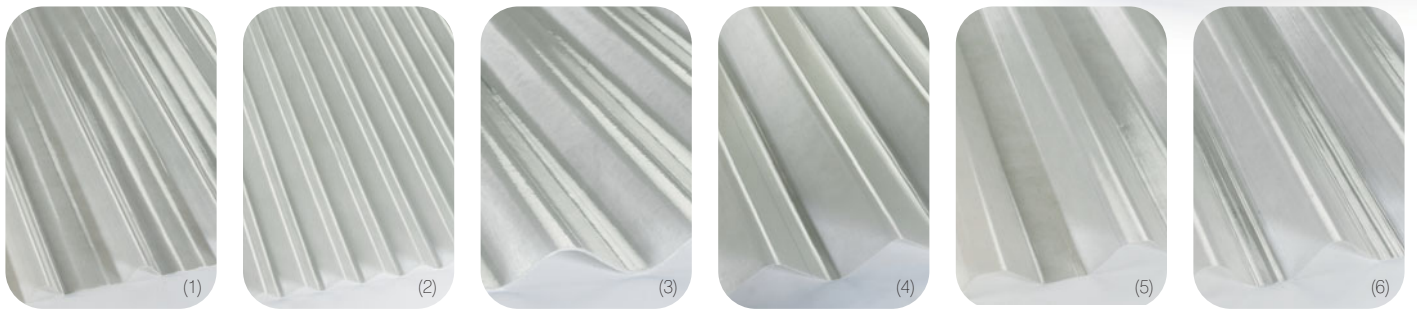

GRP Fibreglass Rooflights/ Roofing Sheets

With the ever increasing electricity prices it is a good idea to incorporate some natural daylight into your building. Rhino Steel Cladding GRP rooflights allow 92% light transmission through the sheet so an excellent method to brighten up your building and reduce on electricity costs.

Our GRP rooflights are designed to work in conjunction with our box profile, tile effect and traditional corrugated steel roofing sheets. We even stock obsolete profiles such as double six, monad and atlas major tile.

Prime 'Grade A' GRP material, made to Class 3, and a weight of 2.44kg per square metre which is ideal for all agricultural purposes and industrial and domestic buildings.

Box Profile 32/1000 GRP Rooflights (also compatible with Tile Effect 32/1000) (1)

Box profile GRP rooflights consist of six profiles and five valleys where the water runs. Each profile is 32mm deep and at 200mm centres from peak to peak. These rooflights can also be used with tile effect roofing sheets.

Traditional 3 inch Corrugated Profile GRP Rooflights (2)

Traditional corrugated GRP rooflights have 3 inch (76.2mm) profiles from peak to peak.

Big Six Profile GRP Rooflights (3)

Big six profile GRP rooflights consist of eight profiles, each at 6 inch (152.4mm) centres. These sheets are ideal for replacing old brittle rooflights and porous fibre cement sheets.

Double Six M Profile GRP Rooflights (4)

Double six M profile GRP rooflights consist of five profiles, each at 11.81 inch (300mm) centres. These sheets are ideal for replacing old brittle rooflights and porous fibre cement sheets.

Atlas Major Tile/Eternit Deep Profile GRP Rooflights (5)

Atlas major tile profile GRP rooflights consist of four profiles, each at 13.33 inch (339mm) centres. These sheets are ideal for replacing old brittle rooflights and porous fibre cement sheets.

Monad/Cape Monad Profile GRP Rooflights (6)

Monad profile GRP rooflights consist of five profiles, each at 9.84 inch (250mm) centres. These sheets are ideal for replacing old brittle rooflights and porous fibre cement sheets.

Other GRP profiles available upon request.

Z-Purlins and C-Section Purlins

The combination of our Z-purlins and C-section purlins within a building shell construction provides a complete structural solution for roofing and side cladding details.

C-section purlins are designed to form the walls and floor joists of a building shell construction and are also ideal for support beams for mezzanine flooring.

Z-purlins are designed to form the roof and wall joists of a building shell construction.

Our standard Z-purlins and C-section purlins are available up to 3mm in thickness and up to 8m (26.25 feet) in length. Longer lengths can be manufactured if required.

Thickness available:

1.2mm, 1.3mm, 1.4mm, 1.5mm, 1.6mm, 1.8mm, 2.0mm, 2.3mm, 2.5mm and 3.0mm

We also supply anti sag bars and rods, cleader angles, cleats and eaves beams.

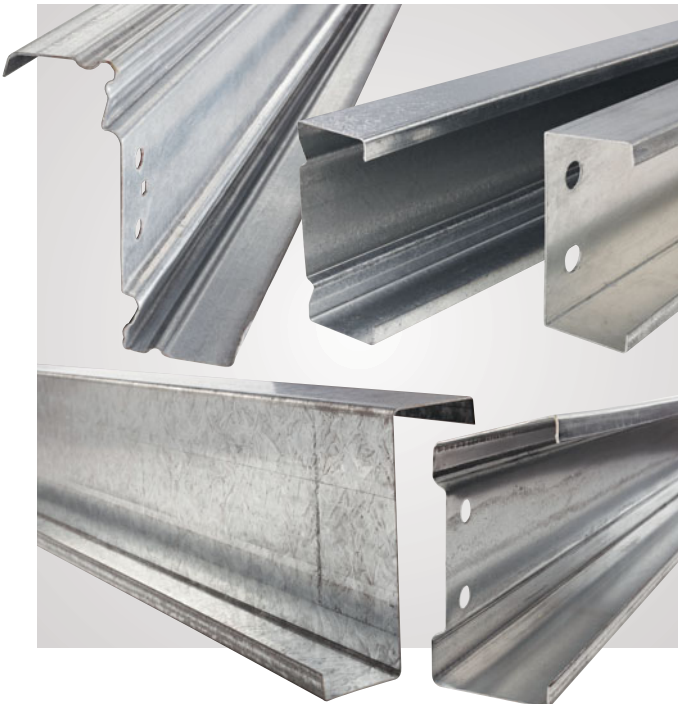

Z – Purlin Heights		C – Section Heights	
Millimetres	Inches	Millimetres	Inches
121mm	4.76"	121mm	4.76"
140mm	5.51"	140mm	5.51"
145mm	5.71"	145mm	5.71"
170mm	6.69"	170mm	6.69"
175mm	6.89"	177mm	6.97"
177mm	6.97"	200mm	7.87"
200mm	7.87"	225mm	8.86"
225mm	8.86"	255mm	10.04"
255mm	10.04"	285mm	11.22"
285mm	11.22"	305mm	12.01"

Flashings

Flashings and cappings are used to weatherproof the edges of roofs and walls. We stock large quantities of barge board flashing and ridge capping and can manufacture any flashing to customers exact requirements.

Barge board flashings can be used on the gable ends of an apex roof, to flash around a single sloping pitched roof and on the corners of buildings. They provide closure between sheets and walls, protection against high winds and ensures a professional neat finish to any building.

Ridge capping is used on the ridge of an apex roof. It provides the closure between sheets to prevent water leakage and protection against high winds.

Our flashings from stock are manufactured in 3m lengths. They are formed and profiled from a flat sheet 1200mm wide and 3m in length. They have a girth of 400mm and consist of a 90 degree angle at the centre of the flashing (200mm x 200mm). They are available in all our standard colours and finishes to match the sheets.

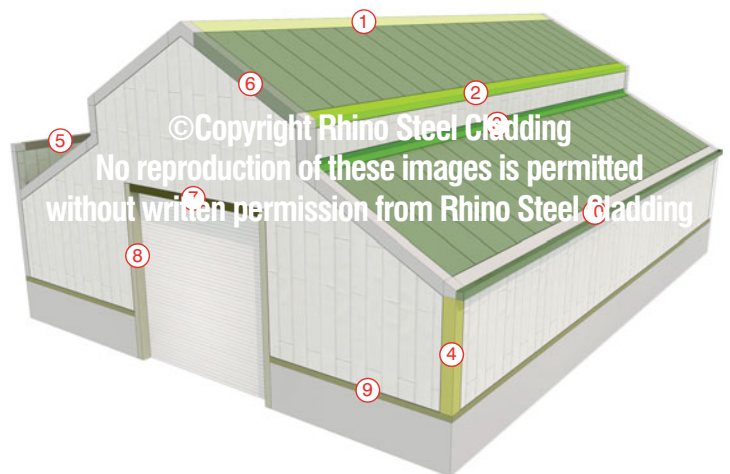

1
APEX RIDGE
CAPPING

2
EAVES FLASHING
(ONLY REQUIRED
WITH DOUBLE
SKIN)

3
ABUTMENT
INTERNAL
FLASHING

4
CORNER

5
U-SHAPED
CAPPING

6
BARGE BOARD

7
HEADER

8
DOOR FLASHING

9
DRIP CILL

10
GUTTERING

Guttering

Galvanised steel gutters, down pipes, stop ends and outlets manufactured to customers exact requirements. All colour coded with plastisol/plastic vinyl coating (PVC) to match the sheets.

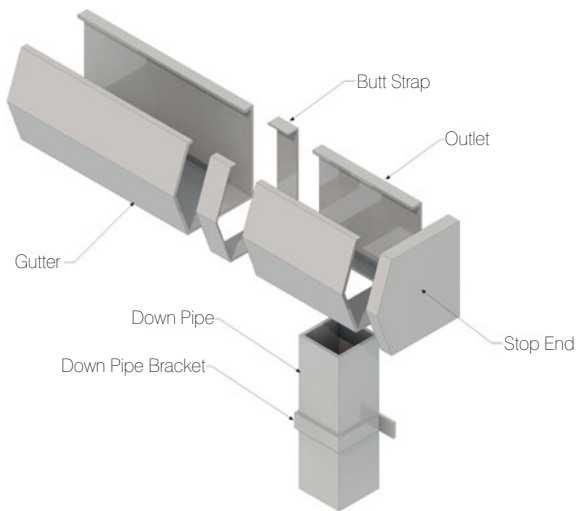

Two standard styles to choose from; new trimline gutter system* (1) and original box gutter system (2). Specific designs can be manufactured to customers requirements.

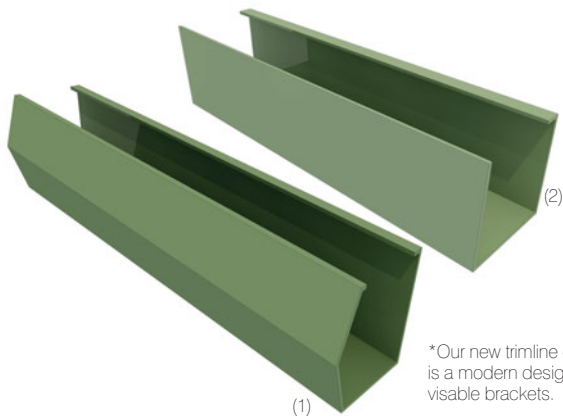

Fixings & Accessories

High quality range of self drilling tek screws for timber, steel and concrete. Each screw has an 8mm hexagon head with a 16mm watersafe washer and a colour coded cap to match the colour of the roofing sheets. All our fixings come in various sizes and in bags of 100 or boxes of 1000.

Foam fillers, lap tape, silicone, J bolts/hook bolts and magnetic sockets also available.



Fitting/Installation

If you require a fitting service, whether it be an existing building requiring overclad or a new build, we can provide an experienced family team of industrial cladders to install our products.



©Copyright Rhino Steel Cladding
No reproduction of these images is permitted
without written permission from Rhino Steel Cladding

Where to find us:
Just 5 minutes from the M42 Junction 9

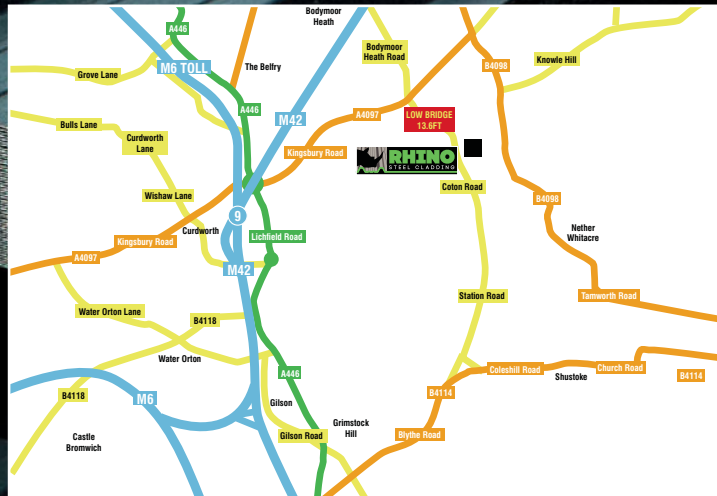

©Copyright Rhino Steel Cladding
No reproduction of these images is permitted
without written permission from Rhino Steel Cladding



Rhino Steel Cladding
The Cedars, Coton Road, Whitacre Heath, West Midlands, B46 2HH.

Tel: 01675 462 692 Fax: 01675 462 852
Email: sales@rhinosteelcladding.com
Web: www.rhinosteelcladding.com