

ventilation

PRODUCT GUIDE

volume 19/a

ventilation
products

for roofs, walls
and floors



Ventilation

Ventilation Guidelines

We welcome you to the range of building envelope ventilation products by Cavity Trays Ltd.

Ventilation to negate the effects of condensation in roofs, walls and floors is necessary to comply with the requirements of the Building Regulations and British Standards. Careful selection of products is always recommended to optimise ventilation levels and performance.

Roof Wall or Floor is highlighted at the top of every product listing

indicating where the product may be used.

At the bottom of every product entry are simple illustrations providing a general guide to the levels of compliant ventilation under the current Building Regulations. Examples of all such illustrations are shown below.

Construction standards vary and so do product standards. Always check compliance and suitability prior to using a product.

Roof Space Ventilation

References: Approved Document F2. BS 5250. BRE Report 262. Approved Document C 2004 edition. BS 5534. NHBC Standards. Zurich Standards. Scottish Technical Standards.

Pitched cold roofs should cross ventilate. The equivalent of a 10mm gap running continuously the full length of both eaves is usual. On pitches above 35° where the spans exceed 10m consider also higher-level (equivalent 5mm) additional ventilation as defined in BS5250.

Single slope (monopitch) roofs may be ventilated (equivalent 10mm) at eaves and (equivalent 5mm) at roof/wall intersection or thereabouts. Always ensure every ventilation route is cross balanced - with entry and exit routes.

Where the insulation follows the roof slope observe the increased aperture requirement at eaves and the need to maintain a free air space above the sloping ceiling. The ventilation level at the top of the roof is 5mm.

In cold roof situations where the roof pitch is below 15° cross ventilate using (equivalent 25mm) rated products. On spans exceeding 10m observe Approved Document F2 guideline by increasing ventilation x 0.6% of roof (plan) area.

One-Way Aspirating Underlay may be used in cold and warm roofs to provide the requisite level of ventilation as an alternative method of compliance. Ensure any need to cross-batten is carried out if applicable. Product instructions provide guidelines.

Suspended floors generally require a minimum of a 150mm void under and balanced cross ventilation. The equivalent of 1500mm² airflow for each metre run of wall is usual or 500mm² for every square metre of floor area – whichever is the greater. Pipes of not less than 100mm diameter may service airflow to voids formed by compartment or sleeper walls. In such circumstances select the compatible connections to appropriate straight or cranked telescopic wall ventilators detailed in this product guide.

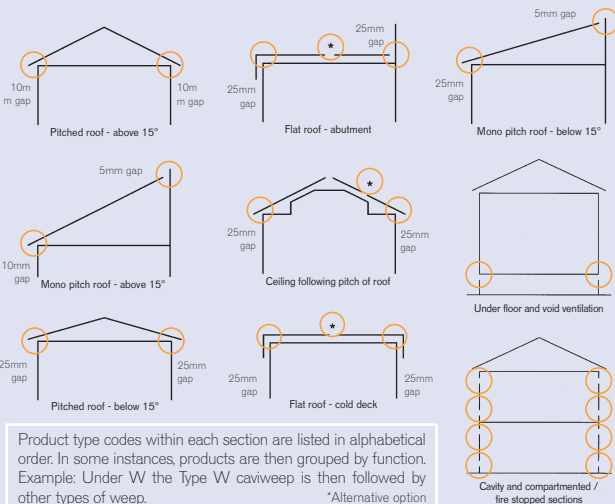

Ventilation Products

Cavibrick	01
Cavibrick Sleeves	01
Cavibrick Rectangular to Round Converter Sleeve	02
Sleeve and Duct Cavitrays	02
Type TAV	03
Extension Sleeves	03
Type TAV to Round Converter	04
Type CSV	04
Type CRSV	05
Type CV	05
Type ECF	06
Type EROV 300/400	06
Type ERV	07
Type FFFV	07
Type OEVWF	08
Type OEVWF-25	08
Type OFV-10	09
Type OFV-25	09
One-Way (heavy duty)	10
One-Way (maximum)	10
Type PV	11
Type RASV	11
Type RAV-FL	12
Type REV	12
Flush Slate Ventilator	13
Contract Slate Ventilator	13
Universal Roof Ventilator	14
Type SSV	14
Type SSV-RU	15
Type SSV-15	15
Type SV-FL	16
Type SV-GP	16
Type T	17
Three in One Roof Ventilation Kit	17
Type USV	18
Type VEP	18
Ventilation Packs	19
Ventilating Flashing	19
Type W	20
Type W Extension Duct	20
Type W Render Cover	21
Euroweep-vent	21

Cavibrick

high performance air-brick

- High air throughput
- Insect screening
- Self-draining base
- Clip together to make up composite sizes
- Range of colours

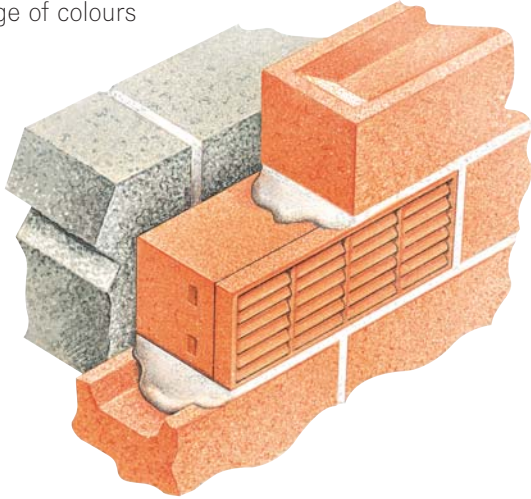

use

The cavibrick is a high performance ventilator which may be used instead of a conventional air-brick.

introduction

Manufactured to brick dimensions, the cavibrick promotes a high air throughput, via a front louvred grille. The louvres are proportioned to maximise performance whilst contouring the air to challenge through-draughts. The louvres are also spaced to comply with the latest BS requirements but have been staggered to offer also an insect resistant screen which is not offered on some standard airbricks.

The cavibrick incorporates a water dam back to prevent rain penetration and crossflow

separators. Moulded in a range of colours, the cavibrick may be used singularly, or in multiples. The cavibrick is fully compatible with our range of telescopic and straight sleeves.

data

- BS polypropylene, in terracotta, slate, beige, brown, white and black.
- Approx. size 220mm x 60mm x 70mm.
- Free airflow up to 7,500mm² per cavibrick.
- May be used singularly or clipped together to create 150 x 225 and 225 x 225mm sized airbrick assemblies.
- Packed in boxes containing 50no.
- Smaller quantities available.
- Attachments available – see entries.

Cavibrick Sleeves

- Range of sizes
- Compatible with Cavibrick
- Fold flat storage
- Unobstructed airflow

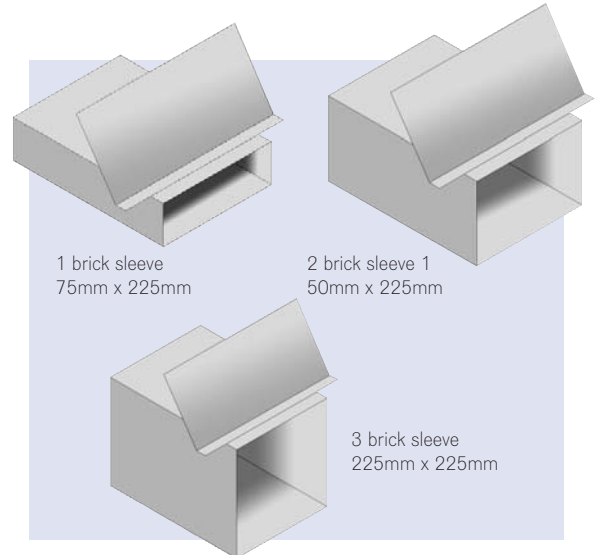

use

Sleeve attachments to provide ventilation to specific areas.

introduction

A range of straight sleeves to accommodate one, two or three cavibricks. (High throughput cavibricks are designed to be used singularly or can be locked together to form larger brick-sized ventilating units.)

When connected to a cavibrick the combined length is sufficient to accommodate all popular cavity wall widths. The three standard straight sleeves are: 75mm x 225mm, 150mm x 225mm and 225mm x 225mm.

We recommend sleeves are protected with a cavitray where they pass through the cavity, to comply with NHBC/best practice. (See Sleeve and Duct Cavitrays.)

data

- Black polypropylene.
- Length 300mm.
- Special lengths to order.
- 75mm x 225mm, 150 x 225mm, 225mm x 225mm.
- Fold-flat design minimises storage space.
- Packed in boxes containing 50no.
- Smaller quantities available.



Consider for use where shown. See inside cover for key.



Consider for use where shown. See inside cover for key.



Cavibrick Rectangular to Round Converter Sleeve

- Compatible with Cavibrick
- Fits standard pipe
- Unobstructed airflow

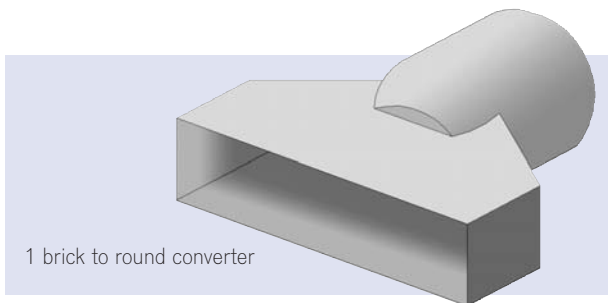

use

Permits cavibrick to be connected to standard pipe.

introduction

Where it is proposed to provide ventilation to a remote room, under floor area or void, a rectangular to round converter sleeve is available to permit the use of standard 100mm nominal plastic soil pipe.

The cavibrick promotes excellent air throughput that can be conveyed using standard pipe if

so required. We recommend sleeves are protected with a cavitray where they pass through the cavity, to comply with NHBC/best practice. (See Sleeve and Duct Cavitrays.)

data

- Black polypropylene.
- Size 70mm x 225mm + circular connection.
- Accepts standard single cavibrick.
- Packed in boxes containing 10no.
- Also available individually.



Consider for use where shown. See inside cover for key.

Sleeve and Duct Cavitrays

- Suits range of cavity sizes
- Compatible with all sleeves
- Prevents tracking

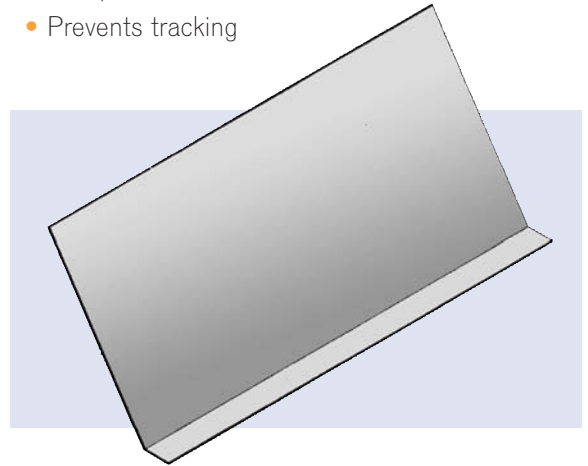

use

Preformed trays to protect sleeves and ducts where they pass through a cavity wall.

introduction

Where a straight or cranked sleeve/duct passes through a cavity, measures should be taken to ensure penetrating water cannot use the upper surface of the sleeve/duct as a means to reach the inside skin. Use of a preformed cavitray prevents water bridging and promotes compliance of the Building Regulations.

The requirement to provide such protection is highlighted in the latest British Standard 5628-3:2001, which specifically refers to ducts and pipes. Recommended for use with Type TAV, straight, and rectangular to round converters.

data

- Solid DPC preformed trays.
- May be used in cavities from 50mm to 140mm.
- Size 330mm x 160mm x 50mm.
- Packed in boxes containing 50no.
- Smaller quantities available.



Consider for use where shown. See inside cover for key.

Type TAV

telescopic adjustable ventilator

- Unobstructed airflow route
- Extends and retracts to suit course level
- Accommodates high performance cavibrick
- Accompanying cavitray
- Horizontal and vertical extension sleeves

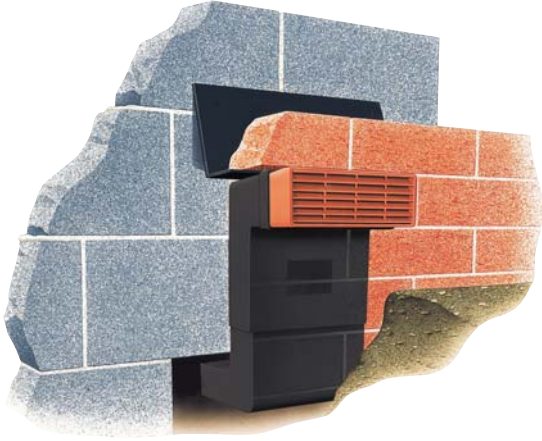

use

Provides cranked air-duct route from cavibrick to area at different level.

introduction

The Telescopic Adjustable Ventilator extends or contracts like a telescope. It extends to a maximum of five brick courses. It is designed to accommodate the high performance cavibrick, or may alternatively be used with a conventional air-brick. Airflow can be directed to a specific area of the structure, at a different level. Where a greater variation is required beyond five courses, an intermediate sleeve is available to extend the range.

The Type TAV offers an unobstructed airflow route to

promote best practice. An accompanying DPC cavitray is also available to order, to provide damp proofing integrity as defined within the Building Regulations.

data

- 225mm x 70mm opening.
- Extended height 370mm/225mm.
- May be used in cavity walls with 50mm cavity upwards.
- BS polypropylene, colour black.
- Maximum airflow when used with approved cavibrick (7,500 mm²)
- Direct flow path.
- Packed in boxes containing 20no.
- Smaller quantities available.

Extension Sleeves

Vertical and Horizontal

- TAV compatible
- Unobstructed airflow
- Available in special lengths

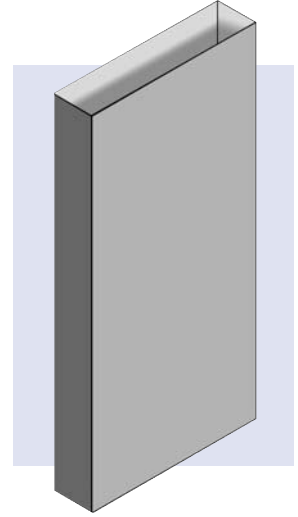

use

To extend Type TAV cranked sleeve to create a greater distance between inlet and outlet level.

introduction

Where airflow is required for a specific area at lower level via a cavity wall, a cranked sleeve is employed with a cavibrick. The (cranked) Type TAV Telescopic Adjustable Ventilator is used for such purposes and provides a five brick courses maximum difference between inlet and outlet levels.

Where a greater vertical difference is necessary, an

extension sleeve is available. Vertical sleeves are available in two standard lengths, with special lengths available to order.

Sleeves can also be supplied to extend the Type TAV horizontally. Specify clearly if required so correctly dimensioned section is supplied. See next entry if you wish to connect pipe to Type TAV.

data

- Black polypropylene.
- Lengths 300mm and 450mm.
- Special lengths to order.
- Packed in boxes containing 10no.
- Smaller quantities available.

Horizontal Extension Sleeves

In instances where it is desirable to horizontally extend the lower TAV aperture inwardly (to accommodate an unusual inner skin dimension or feature), an appropriate horizontal 600mm

long extension sleeve is available. For distances exceeding 600mm horizontally, we recommend use of a Type TAV to Round Connector that permits use of nominal 100mm plastic pipe.



Consider for use where shown. See inside cover for key.



Consider for use where shown. See inside cover for key.



Type TAV

to Round Connector

- Compatible with TAV
- Fits standard pipe
- Unobstructed airflow

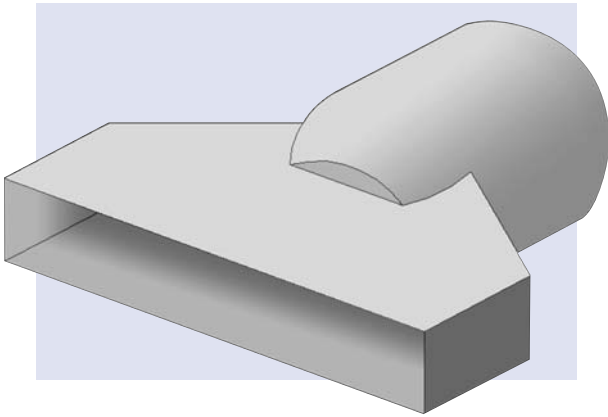

use

To permit attachment of circular pipe to bottom outlet of Type TAV telescopic ventilator.

introduction

Where a plastic nominal 100mm pipe is used to carry airflow to specific parts of a structure, a means of connection to our cranked telescopic ventilator is required.

The TAV to Round Connector is designed for such purposes. This attachment can be successfully

used to provide piped exit routes for radon gas (below floor level) to the perimeter of a building where discharge is via cranked ventilators because of the exterior ground levels.

data

- Black polypropylene.
- Size 50mm x 225mm + circular connection.
- Accepts TAV model only.
- Packed in boxes containing 10no.
- Also available individually.



Consider for use where shown. See inside cover for key.

Type CSV

Circular Soffit Ventilator

- Superior airflow 2,100m²
- New and existing work applications
- Rotate for visual or non-visual appearance
- Insect screening
- Easy regulation compliance



use

Circular Soffit Ventilators with louvres, for new and existing work. Ventilators promote the entry of air into the roof space.

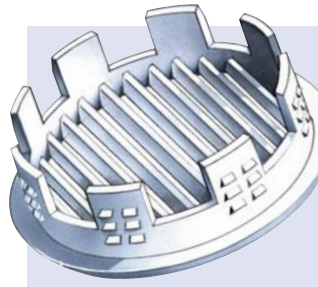

introduction

The upgraded CSV Circular Soffit Ventilator may be introduced into new soffits or existing soffits. It permits easy and quick upgrading of existing structures.

The unique injection moulded ventilator has a deflecting louvred

face, promoting positive air entry and insect screening. Unlike standard ventilators, the unique CSV may be rotated so that the louvres slope downwards towards the masonry face. In so doing, no visible apertures/grilles are apparent to the eye and the result is of a continuous unpenetrated soffit, when a CSV of a matching colour is fitted.

This ventilator has a greater air throughput than most models, and fewer are required per metre run to satisfy requirements.

data

- BS polypropylene.
- Size 79/79mm x 15mm (requires 70mm hole).
- Colours: white, brown, black.
- Free airflow 2100mm².
- Packed in boxes containing 50no.



Consider for use where shown. See inside cover for key.



Type CRSV

Circular Recessed Soffit Ventilator

- High airflow
- Reduces number of soffit apertures
- Insect screening
- New and existing work applications

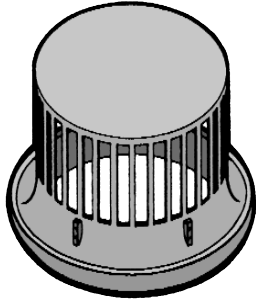

use

To provide airflow in and out of roof space via the soffit board. Suitable for introduction into existing soffit boards to fulfil airflow requirements. Also suitable for new build applications.

introduction

The CRSV differs from the standard CSV as it has a deep body that protrudes up into the soffit box. The airflow apertures are positioned around the sides of the deep body ventilator rather than through the top. This arrangement results in a far greater airflow rating per ventilator. Thus a lesser number

are required to fulfil the statutory airflow levels.

The Type CRSV can be used on most pitches of roof (appropriately spaced) and self-secures when pushed into a 70mm circular hole. Always ensure airflow via a soffit ventilator can reach the parts of the roof intended.

data

- BS polypropylene
- Size 70/90 x 40
- Colours: white, brown and black
- Free airflow 3,420mm² per ventilator.
- Packaged in boxes containing 50no.



Consider for use where shown. See inside cover for key.

Type CV

corbel ventilator

- Suitable for roofs of 15 degrees upwards
- Free airflow 10,000mm² per metre
- Integral insect screen
- Adjustable anchoring ties
- Compatible with our range of eaves ventilators

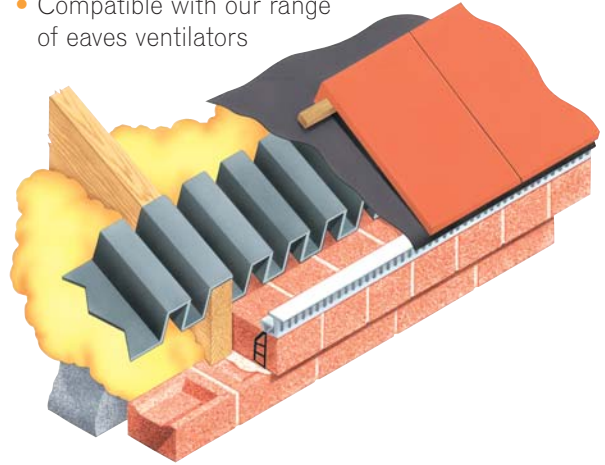

use

To provide air ventilation at eaves level, where a running masonry corbel is constructed.

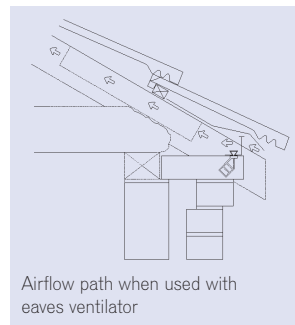

introduction

The Type CV Corbel Ventilator is designed to be incorporated above a running masonry corbel built of brick, stone or similar. The ventilator has a slotted vertical front face, providing the equivalent of a 10mm continuous air opening. To the rear of the ventilator, the base has a dovetail anchoring slot which permits the securing ties to be positively attached at any position to suit the corbel masonry joints.

The Type CV provides an easy way of satisfying the statutory roof ventilation requirements where a masonry corbel exists.

data

- PVCU, black, white.
- 2400mm lengths x 42mm height x 28mm depth.
- Use hardedge or eaves protector to ensure felt clears front face.
- Suitable for new and existing work.
- Integral insect screening.
- Adjustable tie fixing.
- Set-back anchoring position.
- Lengths available individually.

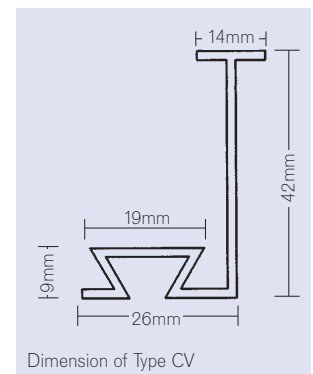

Consider for use where shown. See inside cover for key.



Type ECF

eaves comb filler

- New and existing work applications
- Flexible teeth suit most tile styles
- Integral fixing holes
- Easy regulation compliance



use

To provide ventilating infill whilst preventing entry of birds under contoured roof finishes.

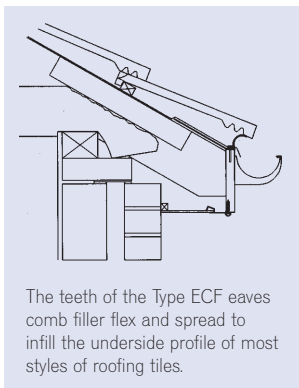

introduction

The eaves comb filler is manufactured from polypropylene

in one metre easy to handle lengths. The supple teeth of the comb flex to accommodate the contours of the tile or sheet. Such flexibility eliminates the need of purpose-made profiles to suit each style of roof finish. Thus the ECF suits a very wide range of profiles. When fixed to the top of fascia, the ECF teeth slope forward, to splay and take up the gap which would otherwise be open.

data

- Flexible grade polypropylene, black
- 1000mm x 55mm.
- Suits wide range of tile and sheet profiles.
- Pre-drilled for immediate fixing.
- Packed in boxes containing 200no.

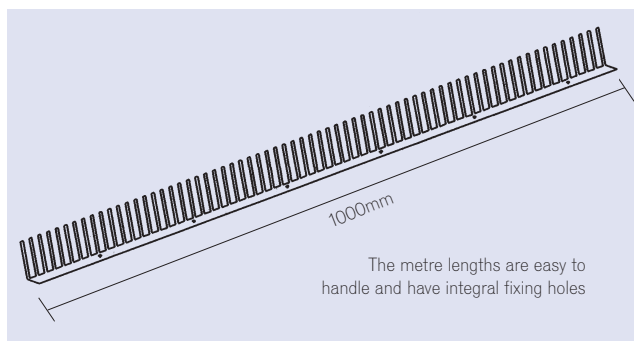

Consider for use where shown. See inside cover for key.

Type EROV 300 Type EROV 400

eaves roll-out ventilator

- New and existing work applications
- Maximum free airflow 30,000mm² per metre
- Suitable for all popular truss centres
- Easy regulation compliance

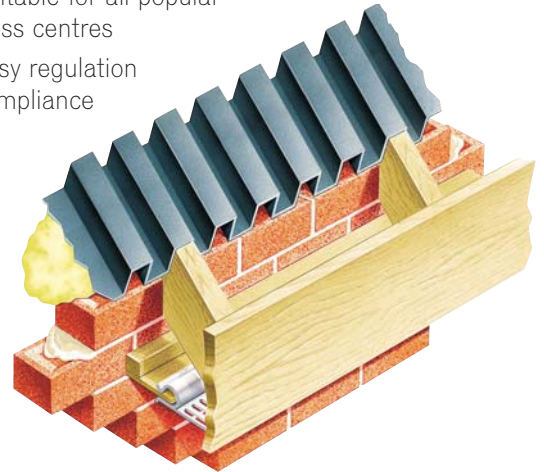

use

Permits entry of air via eaves.

EROV300 is 300mm wide.
EROV400 is 400mm wide.

introduction

The eaves roll-out ventilator is manufactured in PVCU. The cross corrugations permit this product to be supplied in long rolls which are then uncoiled on site across the trusses in the appropriate position. Nails are then used to secure the roll in position.

data

- Material PVCU, lightweight rigid.
- Colour black.
- Standard 6 metre rolls.
- Free airflow 25,000 - 30,000mm² per metre run.
- Suits all popular truss centres.
- Compatible with soffit and fascia ventilators.
- Packed in boxes containing 8no. rolls.
- Smaller quantities available.
- State whether you require EROV 300 or EROV 400.

The result is an evenly spaced air route along the eaves, providing ventilation in accordance with the Building Regulation requirements. Type EROV is available in two sizes:

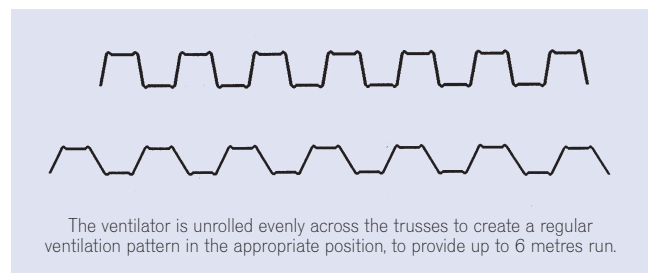

Consider for use where shown. See inside cover for key.

Type ERV

external roof ventilator

- High free airflow of 6,000mm²/12,000mm²
- Natural lead finish
- Integral baffles and drain-out slot
- New and existing work applications



use

To provide ventilation within flat and low pitched roofs.

introduction

The Type ERV External Roof Ventilator is designed to permit the roof void to breathe and prevent condensation occurring. Intended for use on lead covered, felted or similarly decked roofs, the Type ERV is manufactured from lead to BS EN 12588:1999.

When positioned on a plinth or raised surface to suit the application and location, the Type ERV can provide a means of exhausting moist air out of the

structure. Two sizes / air throughput ratings are available. The use of a traditional lead benefits a natural finish that adopts a silver-grey appearance as it ages.

data

- British Standard lead to BS EN 12588:1999.
- 210mm x 140mm x 160mm high + base surround.
- ERV Small: rating 6,000mm².
- ERV Large: rating 12,000mm².
- 405mm x 140mm x 160mm high + base surround.
- Integral insect grille and drain-out aperture.
- Available individually.

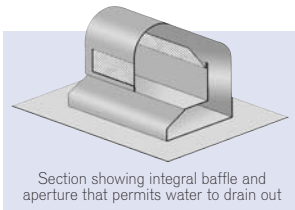

Section showing integral baffle and aperture that permits water to drain out

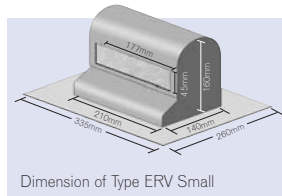

Dimension of Type ERV Small



Consider for use where shown. See inside cover for key.

Type FFFV

four-function fascia ventilator

- Ventilates, supports, protects and infills tiles
- Suitable for pitches of 15 degrees upwards
- New and refurbishment applications
- Ensures consistent build detail



use

Promotes airflow in and out of roof space via fascia top whilst providing eaves comb facility and eaves protection.

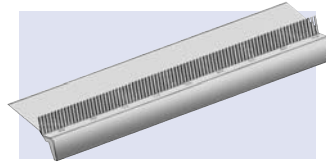

introduction

The Type FFFV is a heavy-duty fascia ventilator that sits on the fascia top. It has an extended inboard that provides eaves protection to which is attached an eaves comb filler designed to prevent bird entry under the contours of rolled tiles. Use of the Type FFFV permits the soffit board to be uninterrupted with apertures or ventilation strips. Alternatively this product may be used where it is intended to position the fascia against the external skin without a soffit.

The airflow rating via the integral insect screen of the Type FFFV (10,000mm²) makes it suitable for roofs above 15 degrees.

data

- Length 900mm x 60mm height x 55mm width.
- 150mm inboard section and 70mm combs.
- Colour black.
- 10,000mm² per metre rating.
- Adjoining lengths interlock to form continuous run.
- New and refurbishment applications.
- Suitable for roofs of 15 degrees upwards.
- Available individually.

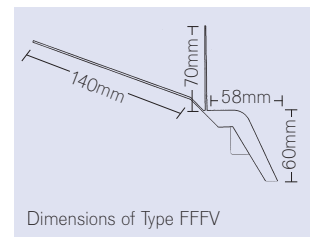

Dimensions of Type FFFV



Consider for use where shown. See inside cover for key.



Type OEVWF

open eaves ventilator with flyscreen

- For open-eaves and non-fascia applications
- Integral fly screening
- All roof pitches accommodated
- Easy regulation compliance
- 10,000mm² and 25,000mm² rating

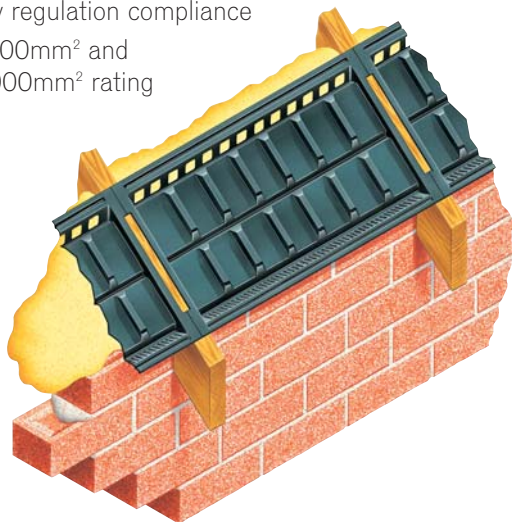

use

Permits entry of air into the roof space via eaves.

introduction

Preformed ventilator with flyscreen. For use between open eaves, without soffits. Provides ventilation route into the roof space.

The OEVWF is designed for use with open eaves details. (Cottage-style open-timber detail, with stand-off fascia but no infilling soffit board.) The open eaves ventilator is suitable for use in new-build or re-roofing projects. When located in position, the flyscreen permits air entry whilst promoting insect-resistant status. Manufactured of lightweight rigid PVCU, the open eaves ventilator with flyscreen provides an

economical way of constructing in accordance with Building Regulations.

data

- OEVWF/400 (use with 400mm truss centres).
- PVCU black.
- OEVWF/450 (use with 450mm truss centres).
- OEVWF/600 (use with 600mm truss centres).
- Versions promote a free airflow equivalent exceeding 14,000mm², per metre run.
- Integral flyscreen.
- Compatible with open eaves details.
- Primarily designed for roof pitches above 15°
- Packed in boxes containing 50no.
- Smaller quantities available.

Dimensions of OEVWF/600

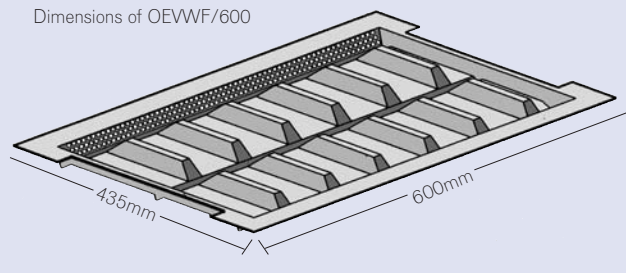

Consider for use where shown. See inside cover for key.

Type OEVWF-25

open eaves ventilator with flyscreen

- For open-eaves and non-fascia applications
- Integral fly screening
- All roof pitches accommodated
- Easy regulation compliance
- 10,000mm² and 25,000mm² rating



use

Permits entry of air into the roof space via the eaves.

introduction

The Type OEVWF-25 eaves ventilator is suitable for use with roof pitches below 15 degrees. The 25 designation identifies this product as providing the equivalent of a 25mm continuous air gap. (Equates 25,000 mm² per metre run.) Insect screening is via punched holes in the lower leading edge. Suitable for lower pitched roofs where no soffit is fitted.

data

- Suitable for pitches below 15 degrees.
- PVCU black.
- Available for 600mm truss centres only.
- Compatible with open eaves details
- Integral insect screening
- Packed in boxes containing 50no.
- Smaller quantities available.

Typical airflow path when Type OEVWF is fitted.

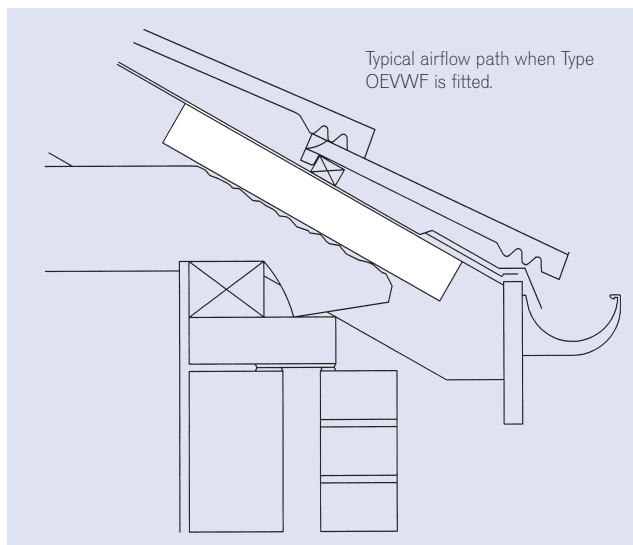

Consider for use where shown. See inside cover for key.

Type OFV-10

over fascia ventilator

- Hidden ventilation at top of fascia
- All roof pitches accommodated
- Integral insect screening
- Reduces fascia size and cost
- Provides statutory airflow

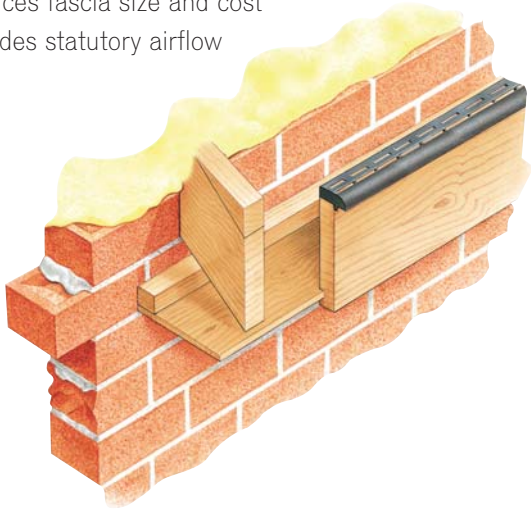

use

Alternative entry route for airflow servicing the roof space.

introduction

Over Fascia Ventilators are suitable for new and refurbishment work.

They eliminate the need for visible soffit ventilation and can be installed in non-soffit locations.

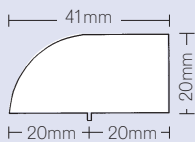

Over fascia ventilator OFV10, for roofs requiring the equivalent of a 10mm continuous gap. Suitable for roof pitches of 15 degrees upwards.

The Type OFV -10 is shaped to permit easy fixing to the top of the fascia board. It has an airflow rating of 12,500mm² per metre, making it suitable for use with roof pitches of 15 degrees and above. Integral insect screening.

data

- Polypropylene.
- Colours: black or white.
- 12,500mm² airflow rating.
- Size: 1000mm x 40mm wide x 20mm high.
- Suitable for roof pitches above 15°
- Integral insect screening.
- Integral fixing location holes.
- Packed in boxes containing 50no.
- Smaller quantities available



Consider for use where shown. See inside cover for key.

Type OFV-25

over fascia ventilator

- Hidden ventilation at top of fascia
- All roof pitches accommodated
- Integral insect screening
- Reduces fascia size and cost
- Provides statutory airflow

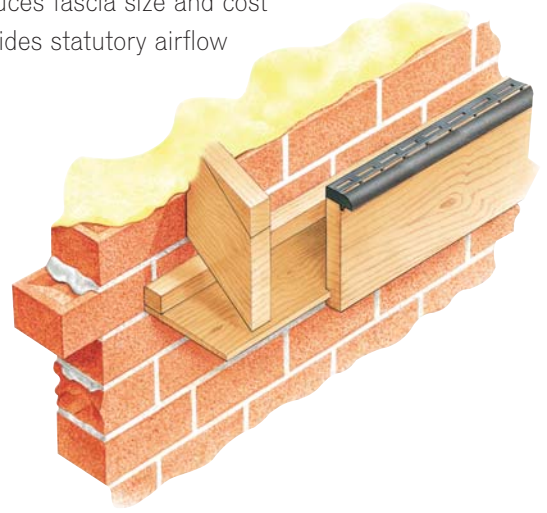

use

Alternative entry route for airflow servicing the roof space.

introduction

The Type OFV -25 is shaped to permit easy fixing to the top of the fascia board. It has an airflow rating of 25,000mm² per metre, making it suitable for use with roof pitches of 15 degrees and below.

Over Fascia Ventilators are suitable for new and refurbishment work. They eliminate the need for visible soffit ventilation and can be installed in non-soffit locations. Integral insect screening.

data

- Polypropylene.
- Colour: black only.
- 25,000mm² airflow rating.
- Size: 500mm x 57mm wide x 48mm high.
- Integral insect screening.
- Integral fixing location holes
- Primarily designed for roof pitches above 15°
- Packed in boxes containing 50no.
- Smaller quantities available.

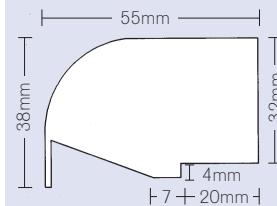

Over fascia ventilator OFV25, for roofs requiring the equivalent of a 25mm continuous gap. Suitable for roof pitches below 15 degrees.



Consider for use where shown. See inside cover for key.

One Way (heavy duty)

aspirating roofing underlay for non-ventilated pitched roof systems

- Safely ventilates moisture vapour
- Protects against water ingress
- Robust stabilized barrier
- Part L benefit

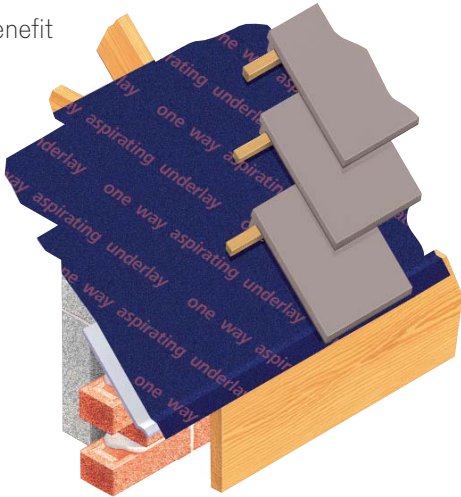

use

One-Way (Heavy Duty) is an aspirating roofing underlay for non-ventilated pitched roof systems. One-Way may be used in non-ventilated cold roof and most warm roof applications when comprising one part of a pitched roof system.

introduction

On pitched roofs this product may be used instead of conventional underlay felt. It provides tough and durable protection from the weather of the area covered, having been tested in terms of strength, stabilisation and resistance to water. (One-Way Heavy Duty supports 6 metres of water). Importantly One-Way permits the roof to breathe. Moisture vapour generated within a property can safely ventilate through One-Way (Heavy Duty). The aspirating benefit is capable of venting over five times the moisture generated within a typical house. Thus this product can be used to satisfy the protection, ventilation and vapour aspirating qualities demanded by the Building Regulations and provides an alternative to the use of conventional ventilation products and methods.

general

This material has been tested to

meet/contribute to the requirements of Building Regulations (England and Wales) 2000, C4, Regulation 7. Building Standards (Scotland) Regulations 1990, Regulation 10, B21, B2.2, G31. Building Regulations (Northern Ireland) B2 and C4. One-Way aspirating underlay may also be used as a supported or unsupported underlay in tiled and slated roofs constructed in accordance with BS 5534. Always consider the complete roof construction (from ceiling boards to roof tiles) with regard to condensation risk. Install only in accordance with our installation instructions that accompany every order.

data

- Size 50m x 1.5m or 75m x 1m
- Weight 10.9 kg per roll.
- Colour: dark blue
- Construction 3 layer PP.
- Thermally bonded. (not reliant on glue for stability or weight).
- Weight 130 gm².
- Strength (nail tear N) 135/155
- Vapour resistance 0.19MNs/g (breathability).
- Water resistance hydrostatic head >600cm H₂O.
- Elongation MD/CD, % 60/60.
- Tensile MD/CD, % 255/192.



Consider for use where shown. See inside cover for key.

One Way (maximum)

aspirating roofing underlay for non-ventilated pitched roof systems

- Safely ventilates moisture vapour
- Protects against water ingress
- Robust stabilized barrier
- Part L benefit

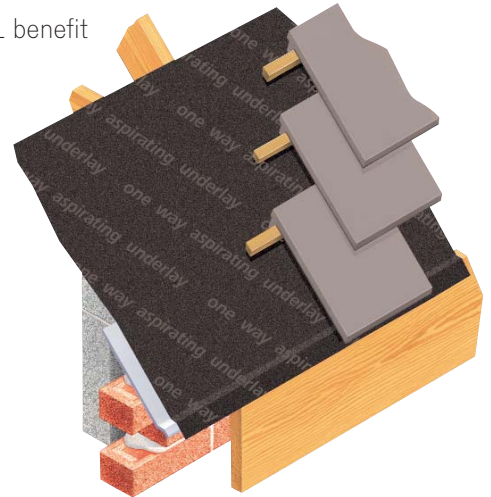

use

One-Way (Maximum) is an aspirating roofing underlay for non-ventilated pitched roof systems. The 'Maximum' suffix qualifies this is the heaviest aspirating underlay available. The performance is very similar to One-Way (Heavy Duty), but the thermally bonded structure is thickened. One-Way (Maximum) provides the strongest possible protection and the highest possible resistance against tearing and ripping.

introduction

One-Way (Maximum) is suitable for use in all warm and cold-pitched roof applications. Moisture vapour generated within a property can safely ventilate through One-Way (Maximum). The aspirating benefit is capable of venting over five times the moisture generated within a typical house. Thus this product can be used to satisfy the protection, ventilation and vapour aspirating qualities demanded by the Building Regulations and provides an alternative to the use of conventional ventilation products and methods.

general

This material has been tested to meet/contribute to the

requirements of Building Regulations (England and Wales) 2000, C4, Regulation 7. Building Standards (Scotland) Regulations 1990, Regulation 10, B21, B2.2, G31. Building Regulations (Northern Ireland) B2 and C4. One-Way aspirating underlay may also be used as a supported or unsupported underlay in tiled and slated roofs constructed in accordance with BS 5534. Always consider the complete roof construction (from ceiling boards to roof tiles) with regard to condensation risk. Install only in accordance with our installation instructions that accompany every order.

data

- Size 50m x 1.5m or 75m x 1m
- Weight 12.375 kg per roll.
- Colour: grey
- Construction 3 layer PP.
- Thermally bonded. (not reliant on glue for stability or weight).
- Weight 165 gm².
- Strength (nail tear N) 200/220
- Vapour resistance 0.21MNs/g (breathability).
- Water resistance hydrostatic head >700cm H₂O.
- Elongation MD/CD, % 50/60.
- Tensile MD/CD, % 330/250.



Consider for use where shown. See inside cover for key.



Type PV

panel ventilator

- Suitable for roof pitches of 15 degrees upwards
- Compatible with fascia and soffit ventilators
- Easy-fit
- Excellent free airflow



use

Permits air entry into the roof space via the eaves.

introduction

In pitched roof applications, the Type PV panel ventilator fits between the roof trusses and maintains a defined airflow path between the underside of roofing felt and the roof insulation. The function of the Type PV is to receive air that enters and exists via a fascia or soffit ventilator. Air is channelled through the body of the ventilator via apertures within the bottom and top upstand edges. The Type PV is available in three sizes, all of which promote an airflow exceeding 10,000mm² per metre run, when fitted continuously along the eaves.

data

- PVCU, colour black.
- Suitable for roof pitches of 15 degrees upwards.
- PV/400 for 400mm truss centres.
- PV/450 for 450mm truss centres.
- PV/600 for 600mm truss centres.
- Sizes as above x 410mm width.
- Easy compliance of BRE detail, Thermal Insulation: Avoiding Risks.
- Use with any compatible fascia or soffit ventilator.
- Packed in boxes containing 50no.
- Smaller quantities available.

Panel Ventilator dimensions.

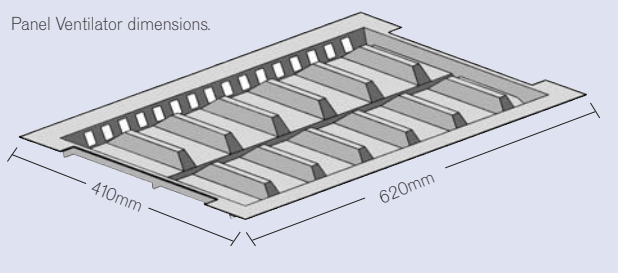

Consider for use where shown. See inside cover for key.

Type RASV

reversible angled soffit ventilator

- Reversible profile for sloping soffits
- Integral insect screening
- Self coloured - corrosion proof
- Easy regulation compliance

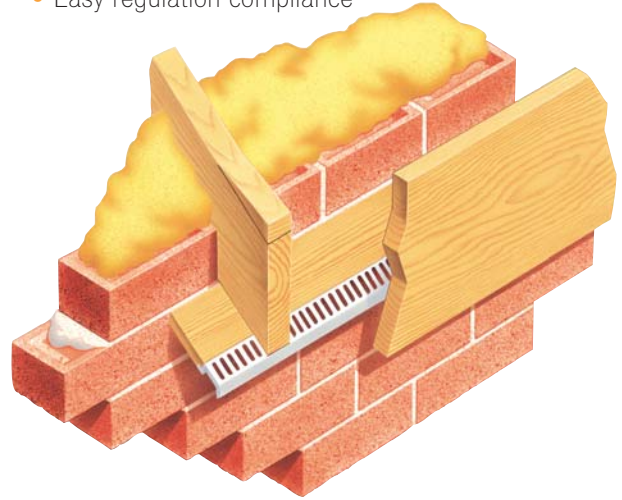

use

Permits entry of air via soffit.

introduction

The Type RASV strip soffit ventilator is designed for use with a standard horizontal or sloping soffit boards on roof pitches of 15 degrees or above. The airflow rating is 10,000mm² per metre run. The ventilation slots provide screening in accordance with regulations.

The Type RASV may be inverted and used at the top or bottom of a sloping soffit.

data

- PVCU compound.
- Colours: white, brown or black.
- Size: 2400mm x 60mm.
- Airflow rating 10,000mm².
- Insect screening.
- Suitable for pitches above 15 degrees.
- Packed in boxes containing 20no.
- Smaller quantities available.

Dimensions of Type RASV

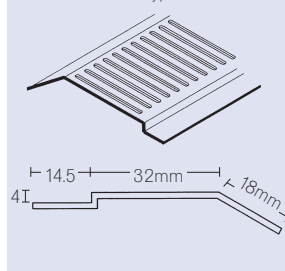

Consider for use where shown. See inside cover for key.



Type RAV-FL

room ventilation packs and gas appliance packs

- Permits roof to breathe at masonry intersection
- Integral insect screening
- High airflow - 25,000mm² per metre run
- Removable when re-roofing

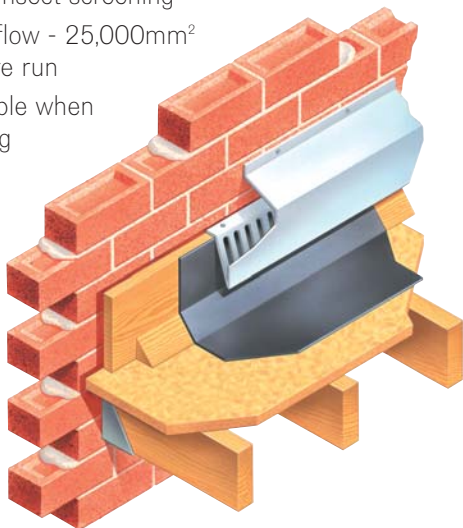

use

To provide ventilation where flat roofs abut masonry.

introduction

The RAV-FL promotes air entry where a flat roof abuts a vertical masonry wall. It is supplied with pre-drilled fixing holes and an integral insect-resistant grille. Each unit is 1.2 metres in length and the heavy-duty profile incorporates an integral pivothold hinge. This hinge permits easy and direct fixing, as the profile may be secured to the vertical board upstand when opened like a book.

The profile is then closed and fixing completed by securing the top of the profile to the masonry wall. An air ventilation path which complies with the current regulations is established at the flat roof intersection. The product is compatible for use with our horizontal intersection cavitytrays which may be established at a higher level to permit the flashing to be dressed down to cover the external shell of the RAV-FL profile.

data

- RAV-FL = 1.2 metres x 200mm o/a x 50mm o/a x 3mm thickness.
- Integral ventilation grille promotes equivalent of a 25mm continuous gap.
- Grade A1 compound PVCU, grey.
- Available individually.

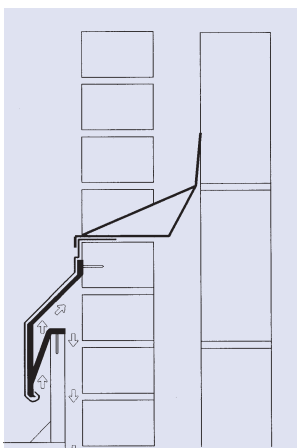

RAV-FL in position showing the ventilation path. Battens fixing vertically at one metre centres ensure the timber upstand is set-off the wall. At higher level a cavitytray is incorporated and the lead flashing covers the exterior of the RAV-FL profile.



Consider for use where shown. See inside cover for key.

Type REV

refurbishment eaves ventilator

- Translucent - checking of correct placement is easy
- Large protected air pocket
- High airflow 10,000mm² per metre run
- Compliance of ventilation regulations

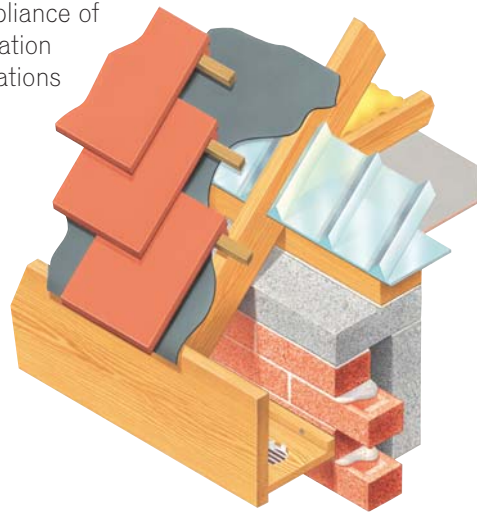

use

Preformed eaves ventilator for introduction between rafters in existing roof spaces.

be used with this refurbishment eaves ventilator.)

data

- PVC, clear or black
- REV600 for 600mm rafter spacing.
- REV400 for 400mm and 450mm rafter spacing.
- Suits numerous truss spacings.
- Excellent free airflow.
- Compatible with other ventilators.
- Delete copy where shown.
- Packed in boxes containing 50no.
- Smaller quantities available.
- Packed in boxes containing 50no.
- Smaller quantities available.

introduction

The refurbishment eaves ventilator fits between rafters and can be placed in position from within the attic space. The ventilator bottom portion rests under the insulation.

The ventilator top hinged portion hinges to follow the roof line. Its simple shape allows air to travel to and from the roof void. Insulation is not permitted to close the gap between the truss rafters. (Note: In existing properties air entry is normally introduced through the existing soffit. Please see CSV circular soffit ventilators which may

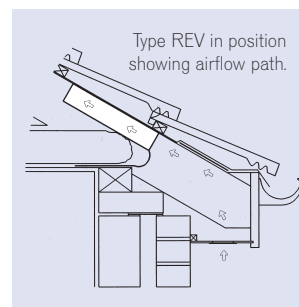
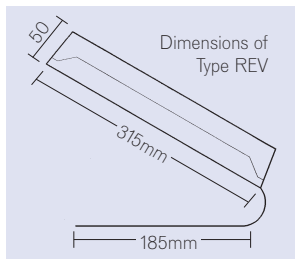

Consider for use where shown. See inside cover for key.

Flush Slate Ventilator

- Low profile - high throughput
- Integral insect screening
- Cut to match slate size
- Easy regulation compliance

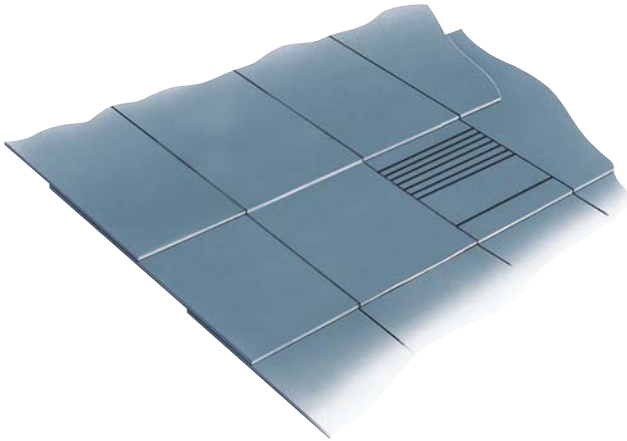

use

To provide ventilation route via slated roof finish.

introduction

The Flush Slate Ventilator has the ventilation apertures moulded within its finish and is suitable for use at high or low positions within the roof surface. When fitted flush with the slates at 2 metre centres, an airflow equivalent of a continuous 5mm gap services the roof space.

Alternatively, when fitted at 1 metre centres this product provides the equivalent of the 10mm continuous gap. The Flush Slate Ventilator may also be supplied with a

connection kit (ref FL/ILS) that can attach to a 110mm soil pipe or similar.

data

- Sizes 600mm x 300mm and 500mm x 250mm.
- Airflow rating of 5,000 or 10,000mm² per metre run subject to centres of fixing
- Slate black-grey colour finish.
- Material: high-density polypropylene.
- Integral grille/screening.
- Connection kit – ask for Flush Slate Connector model FS/ILS.
- Flush Slate Ventilators and Connection Kits are available individually.



Consider for use where shown. See inside cover for key.

Contract Slate Ventilator

- Low profile - high throughput
- Integral insect screening
- Cut to match slate size
- Easy regulation compliance

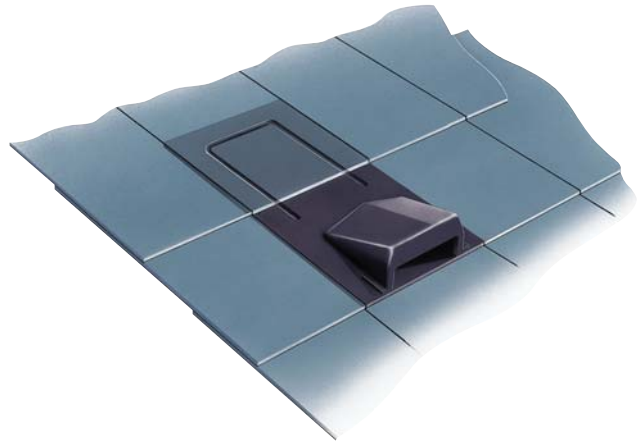

use

To provide a ventilation route via a slated roof, but with an alternative appearance.

introduction

The Contract Slate Ventilator can be readily cut to suit both natural and man-made slates. This single model may be used with either 600 x 300mm or 500 x 250mm slates. The airflow rating via the protective cowl is 10,000mm².

The Contract Slate Ventilator may be used at high or low roof levels at appropriate centres to fulfil the requisite airflow requirements demanded by the Building Regulations.

The Contract Slate Ventilator may also be employed to facilitate

natural non-mechanical extraction and ventilation. This is achieved using the Contract Connector Kit CS/HD that permits connection with a 110mm soil vent outlet. The airflow rating when this kit is attached is 8,000mm².

data

- Size 600mm x 300mm.
- Airflow rating of 5,000 or 10,000mm² per metre run subject to centres of fixing.
- Slate black-grey colour finish.
- Material: high-density polypropylene.
- Integral grille/screening.
- Connection kit – ask for Contract Slate Connector model CS/HD.
- Contract Slate Ventilators and Connection Kits are available individually.



Consider for use where shown. See inside cover for key.



Roof Ventilator

universal high performance roof ventilator for tiled roofs

- High airflow
- Integral baffle and grille
- Suitable for new and refurbished work
- High or low level applications

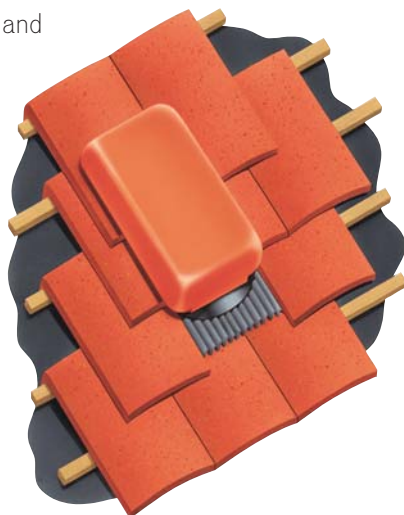

use

Sloping roof ventilator for use at high or low level.

introduction

The universal tile ventilator is designed for use with tiled roofs. Compatible with many styles of interlocking profiled tiles and plain tiles, the universal ventilator may normally be used on roof pitches from 20 degrees up to 70 degrees.

This ventilator promotes an air throughput rating of 15,000mm², through an insect resistant integral screen. An optional adaptor permits the ventilator to be connected to a standard 110mm pipe if required. Position at appropriate centres at high or low level to provide requisite Building Regulation airflow rating.

data

- Base 405mm x 440mm, cap 293mm x 210mm
- Airflow rating 15,000mm².
- PVCU/foam/aluminium.
- Cap available in brown, terracotta or grey.
- Suitable for new and refurbishment work.
- Integral grille/screening.
- Suits wide range of tiles.
- Not recommended for Redland Delta, Cambrian, Saxon, Richmond, Anchor Centurion, Marley Monach, Clay pantiles, Slate. Always determine suitability. Double lap plain tiles require slight modification.
- Adaptor Kit for pipe connection – request Universal/K1
- Ventilator and Adaptor Kits are available individually.



Consider for use where shown. See inside cover for key.

Type SSV

strip soffit ventilator

- Regulation airflow compliance
- Integral fly screening
- Accepts different soffit thicknesses
- Self coloured - corrosion proof

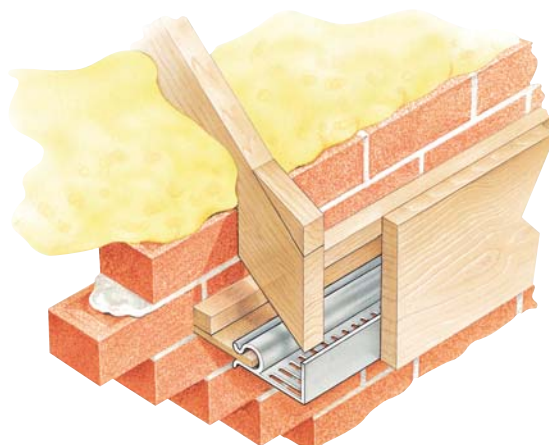

use

Permits entry of air via soffit.

introduction

The Type SSV strip soffit ventilator is designed for use with a standard soffit board. It permits airflow via the soffit area whilst also providing support for soffit boards from 4mm to 14mm thickness. The airflow rating is 10,800mm² per metre run, making it suitable for use where the roof pitch is 15 degrees or above.

The ventilation slots provide screening in accordance with regulations. (See Type SSV-15 for higher airflow rating.)

data

- PVCU compound.
- Colours: white, brown or black.
- Size: 2400mm x 50mm x 20mm upstand.
- Airflow rating 10,800mm²
- Insect screening.
- Packed in boxes containing 20no.
- Smaller quantities available.

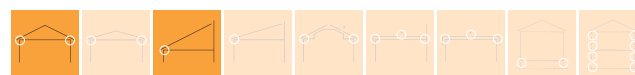
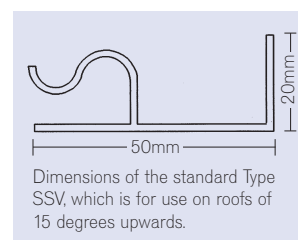

Consider for use where shown. See inside cover for key.



Type SSV-RU

strip soffit ventilator with reduced upstand

- Regulation airflow compliance
- Integral fly screening
- Accepts different soffit thicknesses
- Self coloured - corrosion proof

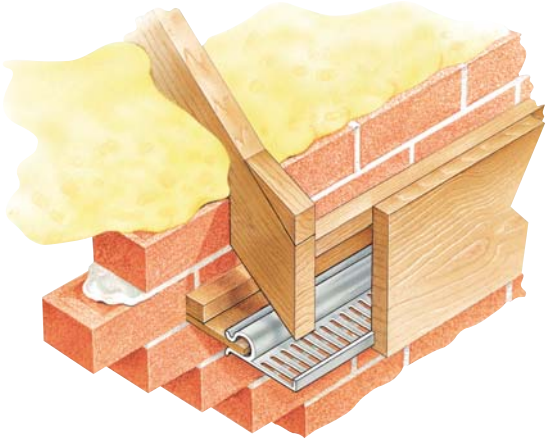

use

Permits entry of air via soffit.

introduction

The Type SSV-RU strip soffit ventilator is designed for use with a standard soffit board. The RU designation refers to a reduced upstand of 5mm. This permits the Type SSV-RU to be fitted into the back location groove of a fascia.

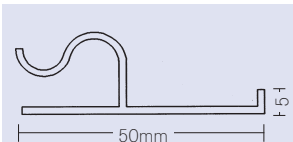

The SSVRU has a reduced upstand of 5mm. It may be fitted into the groove of a fascia.

All other details and dimensions are as per the standard Type SSV. The airflow rating is 10,800mm² per metre run, making it suitable for use where the roof pitch is 15 degrees or above. The ventilation slots provide screening in accordance with regulations.

data

- PVCU compound.
- Colours: white or brown.
- Size: 2400mm x 50mm x 5mm upstand.
- Airflow rating 10,800mm².
- Insect screening.
- Packed in boxes containing 20no.
- Smaller quantities available.



Consider for use where shown. See inside cover for key.

Type SSV-15

SSV15 (for pitches below 15°)

- Regulation airflow compliance for pitches below 15 degrees
- Integral fly screening
- Accommodates different soffit thicknesses
- Self coloured - corrosion proof

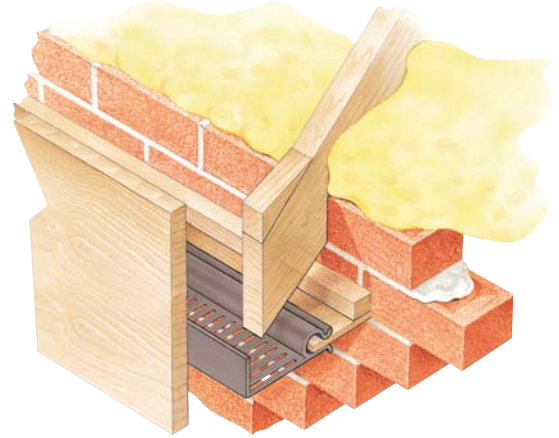

use

Permits entry of air via soffit.

introduction

The Type SSV-15 strip soffit ventilator is designed for use with a standard soffit board on roof pitches below 15 degrees. The airflow rating is 25,000mm² per metre run, making it suitable for use where the roof pitch is 15 degrees or below. The ventilation slots provide screening in accordance with regulations.

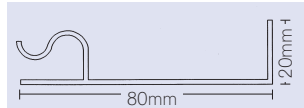

Dimensions of the Type SSV15, which is for use on roofs below 15 degrees pitch and other pitches if the roof space is classified as accommodation. See technical observations.

data

- PVCU compound.
- Colours: white, brown or black.
- Size: 2400mm x 80mm x 20mm upstand.
- Airflow rating 25,000mm².
- Insect screening.
- Suitable for pitches below 15 degrees.
- Packed in boxes containing 10no.
- Smaller quantities available.

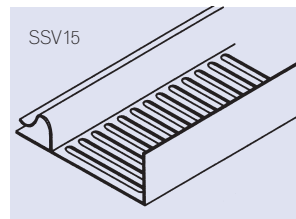

Consider for use where shown. See inside cover for key.



Type SV-FL

flat strip soffit ventilator

- Flat and sloping roof applications
- 25,000mm² airflow rating
- Self coloured – corrosion proof
- Insect screening

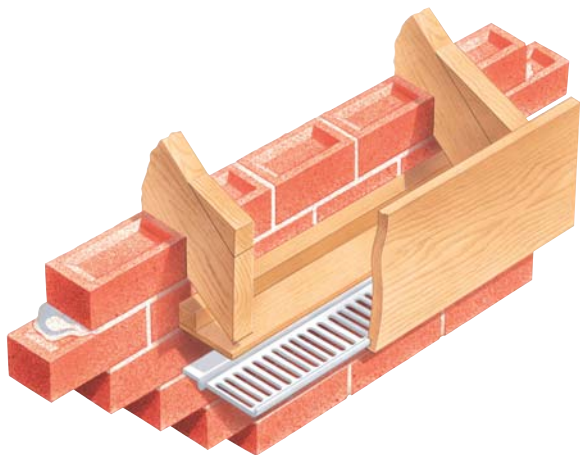

use

Permits entry of air via soffit.

introduction

The Type SV-FL is a strip soffit ventilator designed for use with flat and sloping soffit and has an airflow rating of 25,000mm² per metre run. Thus it may be used where the roof pitch is below 15 degrees.

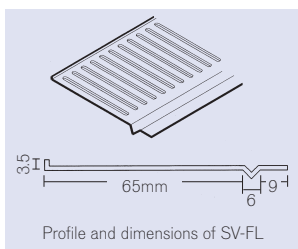

The ventilation slots provide screening in accordance with regulations.

data

- PVCU compound.
- Colours: white or brown.
- Size: 2400mm x 80mm.
- Airflow rating 25,000mm².
- Insect screening.
- Suitable for pitches below 15 degrees.
- Packed in boxes containing 20no.
- Smaller quantities available.



Consider for use where shown. See inside cover for key.

Type SV-GP

soffit ventilator - general purpose

- For sloping and flat roof ventilation
- 25,000mm² airflow rating
- Self coloured - corrosion proof
- Insect screening

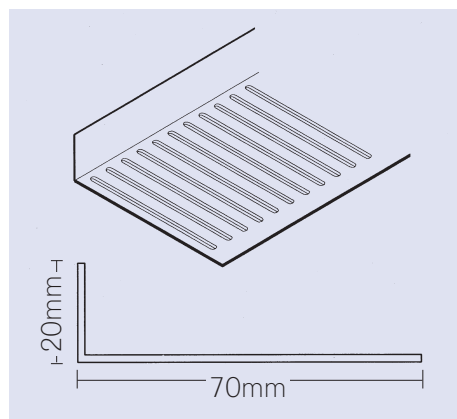

use

Permits entry of air via soffit.

introduction

The Type SV-GP is a general purpose soffit ventilator strip, with an airflow rating of 25,000mm² per metre run. In sloping applications it may be used where the roof pitch is below 15 degrees.

The Type SV-GP may also be used to ventilate flat roofs, necessitating the fascia to be fitted so it stands off the masonry face a distance of just 70mm.

The ventilation slots provide screening in accordance with regulations.

data

- PVCU compound.
- Colours: white or brown.
- Size: 2400mm x 70mm x 20mm.
- Airflow rating 25,000mm².
- Insect screening.
- Suitable for pitches below 15 degrees.
- Packed in boxes containing 20no.
- Smaller quantities available.



Consider for use where shown. See inside cover for key.

Type T

eaves ventilator

- Suits all truss centres
- Suitable for all roof pitches
- Rapid fixing
- Compatible with our fascia and soffit ventilator



use

Preformed eaves ventilator permits airflow requirements into roof space.

introduction

The Type T ventilator is categorised as universal, as it may be used upon a variety of roof pitches, and a variety of truss centres. The Type T does not fit between truss rafters. Instead it clamps the individual truss rafter and creates a free air void on each side, which more than satisfies the statutory airflow requirements.

Approximately 180mm x 400mm x 70mm. The free air space exceeds 15,000mm² per metre run, when used at 600mm centres along the whole length of the roof. The airflow is increased when placed at centres of less than 600mm.

data

- Polypropylene, black.
- Superior free flow of air.
- Suitable for use on a variety of roof pitches and a variety of truss spacings.
- Fully compatible and recommended for use with our fascia and soffit ventilators.
- Universal format reduces stock commitment.
- Packed in boxes containing 50no.
- Smaller quantities available.

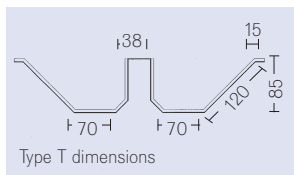

Type T Long Channel



A Long Channel version of the Type T is available in 1200mm lengths for use where insulation restraint is required over a greater area. Typical applications include mansard roof and roof space conversions with the ceiling line following the roof line. Packed in boxes containing 10no. Material and airflow as per Type T.



Consider for use where shown. See inside cover for key.

Three-in-one

roof ventilation kit

- Packaged solution for regulation compliance
- Suitable for roof pitches of 15 degrees upwards
- Easy ordering and stock control
- Integral insect screening



use

Pack providing over fascia ventilation, eaves ventilation and felt support.

introduction

The three-in-one roof ventilation kit provides an easy and economical way of satisfying regulation requirements regarding roof ventilation. Each kit contains sufficient products to cover a six metre run. The contents of each kit are as follows: 1no. 6 metre roll of eaves roll out ventilator (EROV). 10no. felt support trays, contract range (FST/C).

A six metre run of standard over fascia ventilator (OFV). Three-in-one roof ventilation kits may be used with tile and slate roofs. All pack products are also available separately.

data

- Free airflow of 12,500mm² per metre run makes this package suitable for standard pitched roofs above 15 degrees.
- Easy ordering and stock control.
- Packaged solution for regulation compliance.
- Packaged 6 metre kits sold individually.

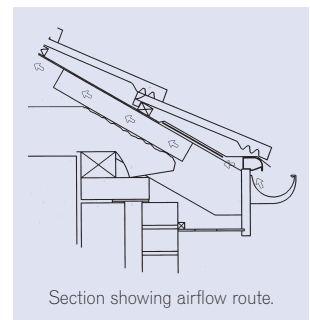

Consider for use where shown. See inside cover for key.

Type USV

universal soffit ventilator

- Easy upgrade of existing structures
- Insect screening
- Hidden fixing with cover moulding
- Self coloured - corrosion proof

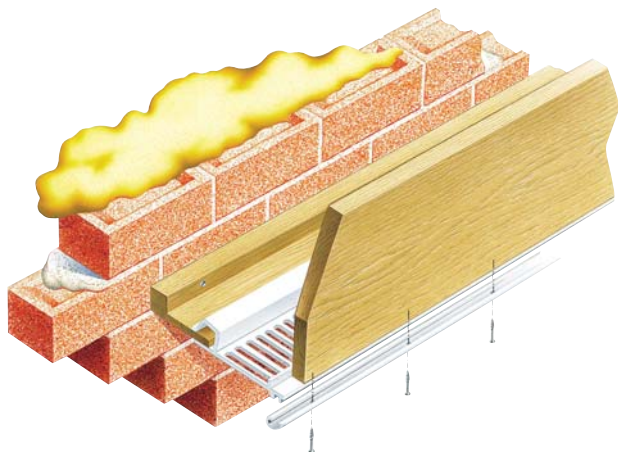

use

Preformed strip ventilator for use at soffit level on new and existing structures.

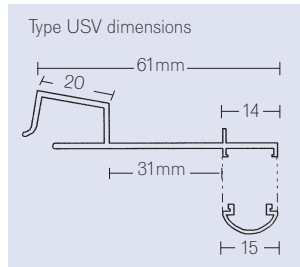

introduction

The Type USV incorporates a direct fixing method from underneath, which is hidden by an attachable feature moulding. This permits the ventilation strip to be secured either to a batten attached to the lower inner face of the existing fascia, or alternatively the strip may be secured directly to the fascia bottom edge.

When the moulded attachment is clipped in position, all screw fixings are hidden from view.

data

- UV stabilised PVCU.
- Available in white or caramel.
- 2400mm lengths, Pre-drilled
- Airflow rating 12,500mm² per metre run.
- Ideal for new and existing work.
- Jaw accepts numerous thicknesses of soffit.
- Packed in boxes containing 20no. Smaller quantities available.

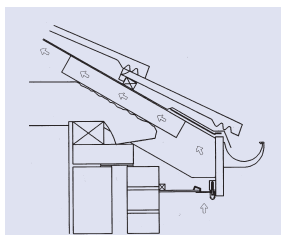

Type USV fitted to an existing flat soffit detail. A counter batten receives the screw fixing and the cover/feature moulding. In this instance the Type USV is fixed to the bottom of the fascia.



Consider for use where shown. See inside cover for key.

Type VEP

ventilated eaves protector (universal)

- Provides felt support
- Prevents water pooling
- Adjusts to all roof pitches
- Integral eaves ventilation
- Airflow ratings to suit all angles of roof



use

Provides support of roofing felt and introduces integral eaves ventilation.

introduction

The Type VEP is a robust felt support eaves protector incorporating a hinged front that adjusts to suit any angle of roof/tilting fillet.

It is designed to prevent sagging felt and water pooling behind the fascia. The body of the Type VEP also incorporates an integral eaves ventilator. Thus this product is dual-function promoting passive ventilation to and from the roof space whilst optimising the service life of the roofing felt.

The extent and depth of any insulation laid in the roof space can be optimised, thus promoting maximum thermal compliance.

data

- 1200mm x 600mm x 29mm (covers two truss spaces at 600mm centres.)
- Suitable for all popular roof pitches from 5 degrees up to 80 degrees.
- BS polypropylene, colour black.
- 25,000mm² airflow rating.
- Universal - does not limit choice of compatible soffit or fascia inlet ventilator.
- Promotes best practice (BRE publication GRG30).
- Packed in boxes containing 5no. (equates 6 metre run).

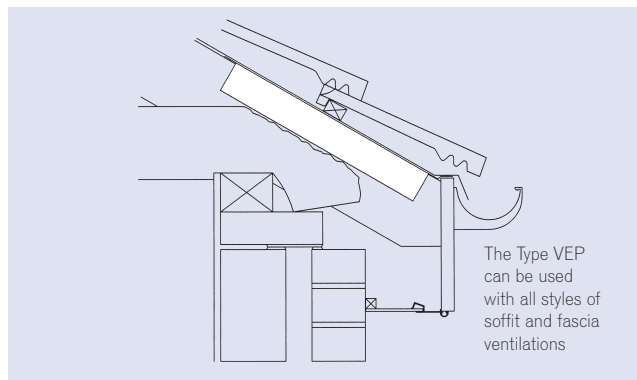

The Type VEP can be used with all styles of soffit and fascia ventilations



Consider for use where shown. See inside cover for key.



Ventilation Packs

room ventilation packs and gas appliance packs

- Three airflow levels
- Complete ventilation packages
- Accompanying protective cavitrays
- Easy stock control and selection

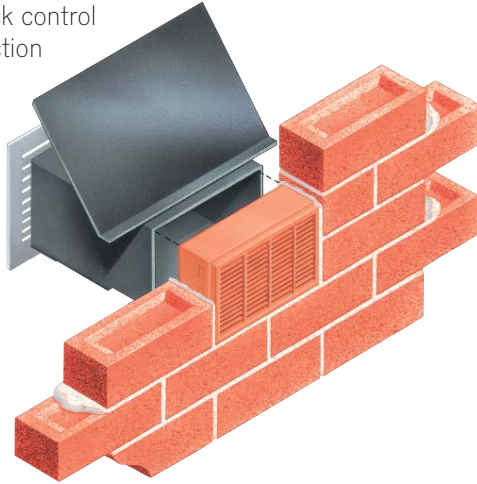

use

Provide ventilation to habitable rooms. Also air ventilation for areas in which boilers are enclosed.

introduction

A total of three packs, each of which consists of a cavibrick(s), a sleeve, an interior grille and a protective DPC cavitrays. Ideal for new construction and refurbishment work.

Pack 1: Single brick size.
6,700mm² airflow rating.
Pack 2: Two brick size.
13,700mm² airflow rating.
Pack 3: Three brick size.
20,700mm² airflow rating.

data

- Material PVCU and polypropylene.
- Exterior bricks in terracotta unless alternative colour ordered.

- Sleeves: black.
- Internal grilles: white.
- Packs available individually.

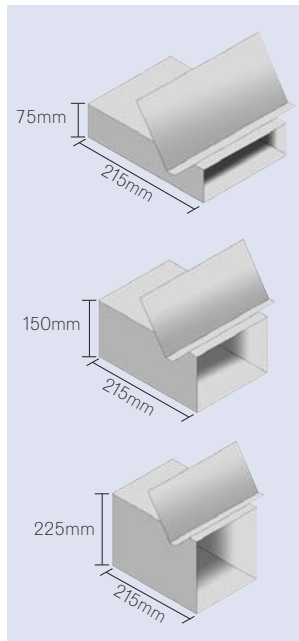

Consider for use where shown. See inside cover for key.

Type VF

ventilating flashing

- Use in place of ordinary lead
- Easy to dress
- Ventilates and flashes in one operations
- Pre-creased for speedy application
- Suits popular roof pitches*

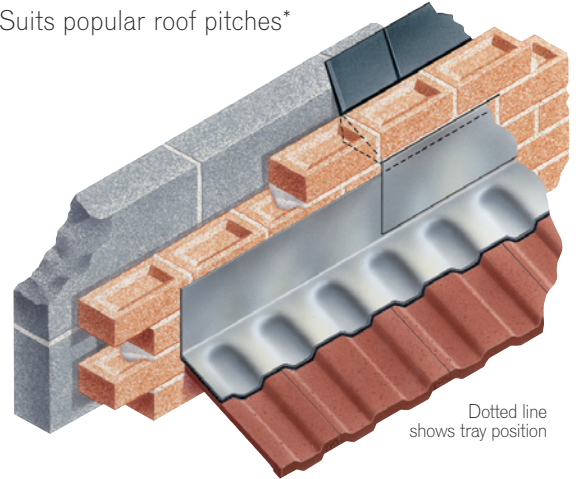

Dotted line shows tray position

use

To provide flashing and ventilation at roof and wall intersections.

introduction

Where a monopitch roof abuts a masonry wall there is a requirement to provide ventilation of the equivalent of a 5mm continuous gap. The Type VF Ventilating Flashing is manufactured from British Standard lead to which is bonded a breathing base layer that permits air to enter and exit.

When correctly incorporated at the roof / wall intersection, and flashing can provide the airflow requirement. Thus the Type VF Ventilating Flashing looks like and may be substituted in preference to ordinary flashing. It offers the advantage of permitting a roof to breathe – naturally. Always make provision for air travelling via the flashing to reach the intended parts of the roof.

data

- Code 4 British Standard lead to BS EN 12588:1999.
- Semi compressible Derexulate breathing base layer.
- Packaged solution for regulation compliance.
- Boxed 3 No. 1200mm x 300mm pre-creased lengths per box.
- Pitch applications 22.5° to 80°.
- May be conventionally restrained if required.
- Available in boxed quantities.

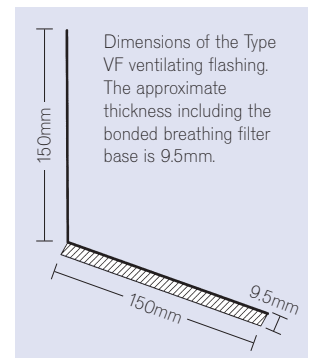

Dimensions of the Type VF ventilating flashing. The approximate thickness including the bonded breathing filter base is 9.5mm.



Consider for use where shown. See inside cover for key.

Type W

perp cavivent and caviweep

- Dual-function combined weep and ventilator
- Insect resistant grille
- Integral water-check baffles
- Superior air throughout and water discharge capability
- Optional render protection cover, keeps grille clean during installation

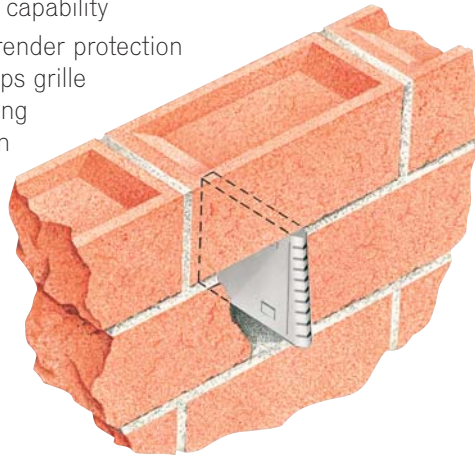

use

Dual-function product acts as a cavity ventilator permitting the cavity to breathe. Also acts as a weep to evacuate water from lintels, dpc's and cavity trays.

introduction

The Type W may be used to provide the balanced air conditions demanded within the cavity in timber-frame construction. The equivalent airflow of an open perp is required every 1.5 metres around the base of the cavity walls and around the top of the same walls. Where such wall cavities are closed or compartmented with the presence of horizontal fire stops or similar, ventilation apertures are required below and above such stops.

Type W cavivents are designed for such purposes. Type W

cavivents are available in a range of colours to blend with the adjacent mortar or masonry.

To the front of each Type W is an insect resistant grille, whilst within the body of the ventilator are baffles to diffuse the effects of directly-blowing winds. Type W cavivents may be used to satisfy the requirements of cavity ventilation.

data

- Size 105/115mm x 65mm x 10mm.
- Free airflow 320mm.
- Use every third or fourth brick to provide compliant balanced ventilation.
- BS polypropylene.
- Colours: grey, black, beige, brown, terracotta, white and translucent.
- Packaged in boxes containing 50no.



Consider for use where shown. See inside cover for key.

Type W Extension Duct

- Compatible with Type W
- Interconnecting facility
- Suits numerous skin thicknesses



use

To extend Type W to accommodate masonry of greater thickness.

introduction

The Type W extension duct is designed to push-fit onto the Type W Caviweep/Cavivent. It converts the standard Type W into a 305mm straight through model. It may also be used to extend the

Type W when employed within a solid retaining wall to provide moisture release.

data

- Material polypropylene.
- Colour grey.
- Size: 200/225 x 65 x 10mm.
- 320mm² air rating.
- Packaged in boxes containing 50no.

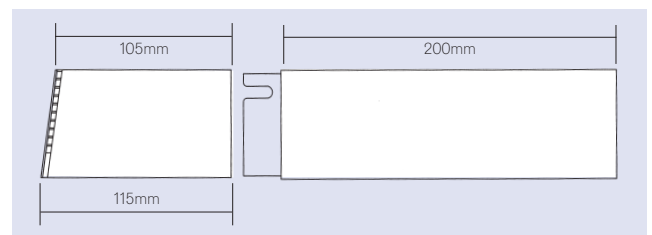

Consider for use where shown. See inside cover for key.



Type W Render Cover

for use during rendering

- Ensures clean and unobstructed grille
- Florescent identification
- Easy release



use

Protective front cover to protect grille of Type W during single or two-coat rendering.

introduction

The Type W caviweep/cavivent is sometimes employed within areas of construction that are to be rendered. The grille on the Type W is purposely set forward, to deflect wind-driven rain blowing into the weep and also to prevent insect fostering within the weep body or beyond. (NHBC Standards Extra 21,2001 referred to the advantage of grilles in preventing insect entry and entry of wind-driven rain.)

The Type W optional cover protects the grille of the weep during rendering. Each cover is brightly florescent coloured, for easy identification and removal following rendering. Please see other weeps within our range, including weep with integral cover, Euroweep, and weep with drop outlet.

data

- Polypropylene.
- Florescent coloured.
- Boxed in 50s.
- Ensures the dual-function Type W caviweep/cavivent promotes optimum performance.
- Packaged in boxes containing 50no.

Euroweep-Vent

alternative perp/weep ventilator

- Dual-function weep and ventilator
- Integral baffle
- Vertical front
- Reduced size without bottleneck exit route

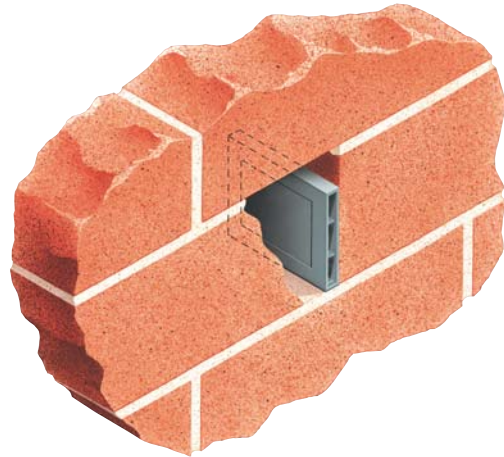

use

The purpose and function of the perp weep/ ventilator is described on the previous pages (Type W). An alternative product is now available offering smaller overall dimensions but with high performance categorisation.

introduction

Euroweep-vents are positioned within the perp joints between masonry. Their function is twofold. They act as a weep to discharge water from DPCs, cavity trays and lintels.

They also act as ventilators to encourage the cavity to breathe. Euroweep-vents were developed and are now extensively used on the continent. They can also satisfy UK, N.H.B.C. and Building Regulation requirements. Compact size does not compromise the

performance of the Euroweep-vent which promotes excellent free airflow and discharge behaviour.

data

- Size 49mm x 87mm x 9mm.
- Free airflow approximately 300mm² per unit.
- BS polypropylene available in grey, black, beige, terracotta and brown.
- Integral baffles.
- Vertical front.
- Boxed in 50s.

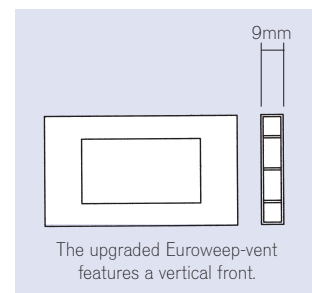

Consider for use where shown. See inside cover for key.



Consider for use where shown. See inside cover for key.



Within this associated products section are accessories and components for use in roof construction and roof access, plus masonry aids and attachments.

When seeking products for any building scheme, we recommend the standards to which you wish to construct are compared and matched with the appropriate solutions we offer.

As part of our continuous product development we reserve the right to amend or change specifications without notice.

Should you have a query or seek a bespoke, non-standard or unusual requirement, please contact our Helpdesk.

Associated Products

Type CRSS	23
Type ECSC	23
hardedge Strip 1200	24
hardedge Strip 1500	24
Type I	25
Joist Gloves	25
Type LAD	26
Downward Opening	26
Type RBS	27
Type VG	27
Silicon Bond	28
Cavilink	28

Type CRSS

continuous running soaker strip

- Pre-shaped for immediate use
- Hidden from view when insulated
- Suitable for pitches from 22.5 degrees up to 60 degrees
- Lightweight and easy to handle

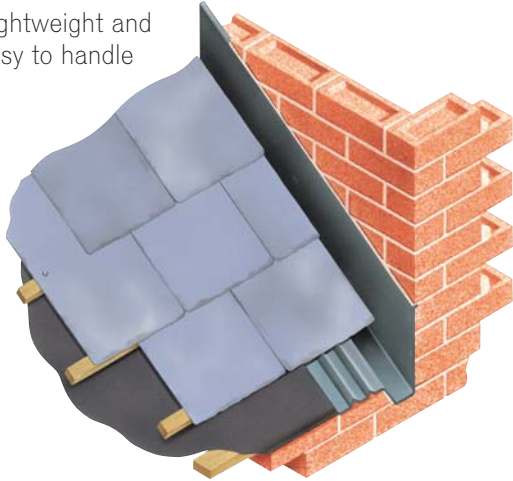

use

Continuous soaker for use with slate roof where it abuts a masonry wall.

introduction

The Continuous Running Soaker Strip is pre-shaped for immediate use. It resembles lead in colour and may be employed with conventional lead at the saddle and the foot. The upstand is unlippped, which eliminates the necessity to chase into the masonry wall.

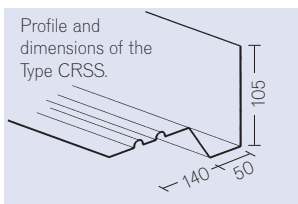

Type CRSS can be directly mechanically secured through its upstand towards the top of the section.

data

- Glass reinforced polyester.
- Colour lead grey.
- 105mm high x 190mm wide x 3000mm.
- Suitable for pitches from 22.5 degrees up to 60 degrees.
- Pre-shaped for immediate use.
- Hidden from view when installed.
- Lightweight and easy to handle.
- Permits use of conventional saddle and foot.
- Available individually.

Type ECSC

eaves continuous slate course

- Reduces costs and site work
- Hidden from view when installed
- Robust and easy to handle
- Suitable for all standard pitches of slate roof



use

As substitute for first (bottom layer) slate course providing support and reducing slate cutting.

introduction

The Eaves Continuous Slate Course replaces the eaves first slate course and establishes rigidity and consistent support off which the slate laying and fixing may commence.

Thus the amount of slate and slate cutting is reduced.

Installation is speedy and savings can be achieved in both time and overall purchasing costs.

data

- Glass reinforced polyester, 1.83 kg/m².
- Colour black.
- 360mm wide x 3000mm long.
- Supplied in packs of 10.
- Reduces costs and site work.
- Hidden from view when installed.
- Robust and easy to handle.
- Suitable for all standard pitches of slate roof.

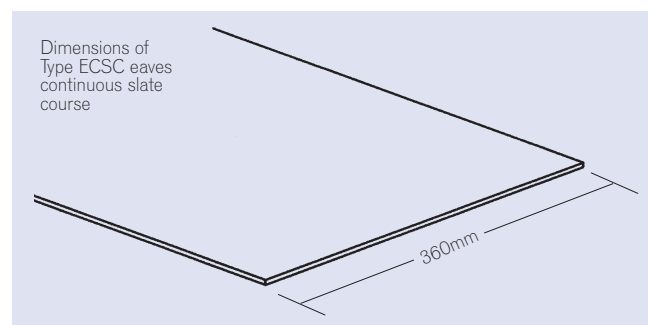

Hardedge Strip 1200

anti-pooling eaves and felt protector strip also special eaves protector*

- Suitable for all roof pitches
- Provides even felt support
- Prevents water pooling
- Promotes correct discharge into gutter

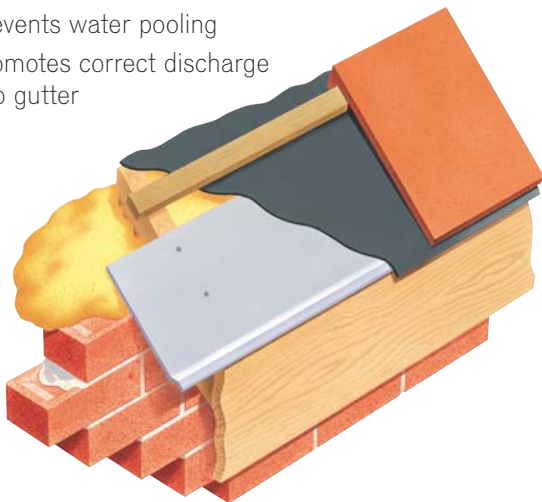

use

Provides robust support and reinforcing of roofing felt at eaves.

introduction

Underlay felt should discharge water into the eaves gutter. This requirement is often flawed, and pooling of water is experienced within the sagging felt area, situated behind the fascia board. The Hardedge anti-pooling strip addresses this aspect.

The Hardedge anti-pooling strip is a rigid preformed polypropylene profile, which is positioned at eaves level prior to the laying of the roofing underlay felt. It provides support of the underlay felt which is positioned and laid in the conventional manner. The underlay felt is prevented from sagging between rafters/tilting fillets, thus addressing the pooling problem.

data

- Rigid polypropylene, black.
- 1200mm x 250mm.
- Suitable for use on roof pitches from 15 degrees up to 45 degrees.
- Provides even support to address anti-pooling.
- Projecting lip promotes correct felt positioning and discharge of water.
- Available in packs containing 10no.
- Smaller quantities available.

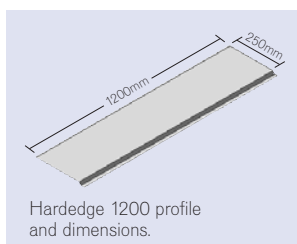

Hardedge 1200 profile and dimensions.

Hardedge Strip 1500

anti-pooling eaves and felt protector strip also special eaves protector*

- Suitable for all roof pitches
- Provides even felt support
- Prevents water pooling
- Promotes correct discharge into gutter

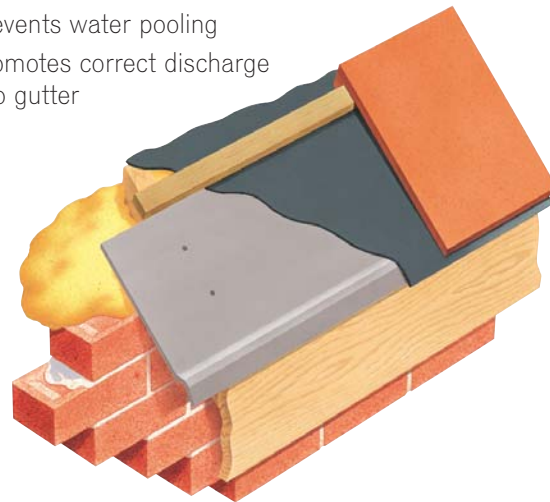

use

Alternative felt support and anti-pooling hardedge for eaves protection.

introduction

The Hardedge 1500 or Special Eaves Support as it is also known, is an extended and profiled version of the 1200 model. It is both longer and wider and offers even greater support and rigidity.

The front of this Special Eaves Protector extends forward to carry the projecting roofing felt forward of the fascia. Thus support is provided to a greater extent and the felt is encouraged to gravitate and terminate into the adjacent guttering. Manufactured from rigid polypropylene, the Hardedge 1500 / Special Eaves Protector is easily and speedily fixed in position prior to the roofing felt.

data

- Size 1500mm x 300mm (225 + 75mm)
- Black PVCU.
- Suitable for use on roof pitches from 15 degrees up to 45 degrees.
- Stops water pooling.
- Supports felt and carries edge forward to gutter.
- Available in packs containing 10no.
- Smaller quantities available.

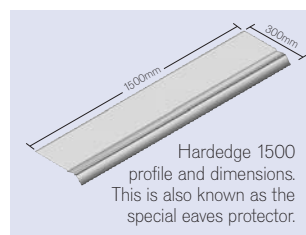

Hardedge 1500 profile and dimensions. This is also known as the special eaves protector.

Type I

in-screed services duct

- Preformed ready-to-use duct
- Integral keying and stability flanges
- Intumescent fire barrier break
- Provides easy access for future maintenance

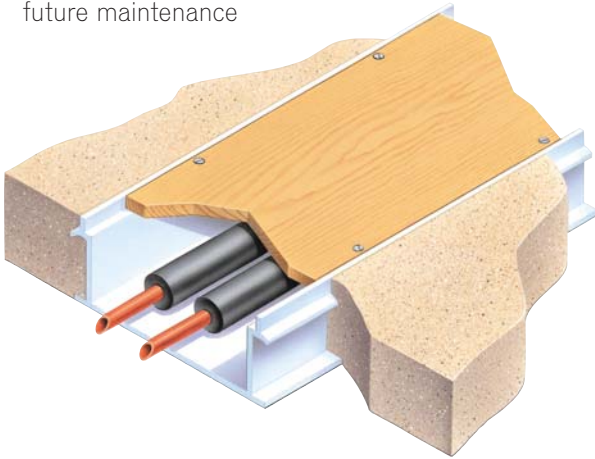

use

Preformed services duct for incorporation within floor screeds. Provides designed accessible routes for service pipes or wiring.

introduction

Ducts are incorporated on level oversite or sub floors, and the final screed finished flush with the duct top edges. Type I ducts accommodate service pipes or service wiring, and support can be provided for pipes using internal clips.

Surface floor covers are available in 12mm plywood, or composition board. Special woven seal glass cloth intumescent barrier bags are available when ducts run from one building compartment to another.

data

- 140mm x 50mm overall, providing approx. accommodation area of 104mm x 38mm.
- Standard length 2400mm.
- Extruded PVCU.
- Colour white.
- Keying and stabilising flanges.
- Available individually.

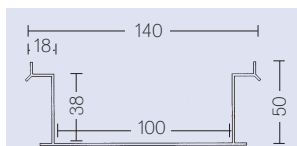

Dimensions of the Type I in-screed services duct.

Joist Gloves

- Address Air Leakage and Thermal Bridging
- Joist-end DPC protection
- For joist envelopment in cavity wall and solid wall construction
- Refurbishment and new construction
- Over 50 rectangular sizes available

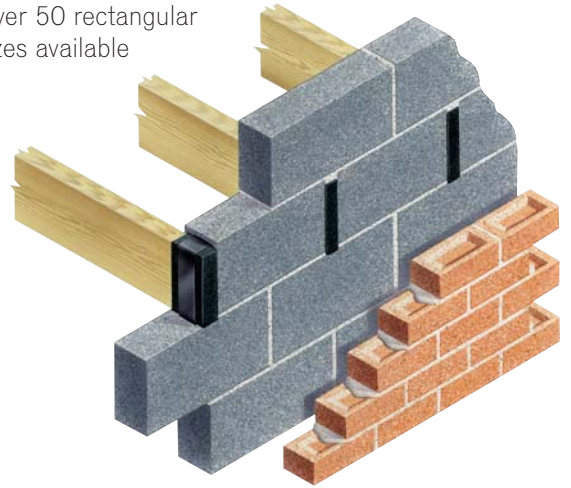

use

To guard against air leakage when traditionally building in timber joists. To protect the ends of rectangular timber joists against dampness.

introduction

The joist glove snugly fits the end of the rectangular joist. It protects against the hygroscopic behaviour of the timber. The exterior of the glove has a compressible seal. Should shrinkage occur, the seal guards against air leakage.

This compressible seal does not rely on pressing against the skin face where the surface finish can be variable. It is actually compressed and enveloped within the block work masonry.

Joist Gloves are lightweight and fold-moulded from polypropylene. The mason applies a Joist Glove to the end of each timber joist and can proceed as normal. There are no flanges to obstruct placement or pointing-in.

data

- Available to suit all rectangular timber joists dimensions.
- Simply state joist height and joist width.
- Manufactured to a depth of 100mm, 150mm or 225mm.
- New and refurbishment work applications.
- Appropriate for solid and cavity construction.
- Black polypropylene.
- Available in any quantity to specific order.



Joist Gloves are available in sizes to suit all rectangular joist dimensions. The perimeter seal is enveloped within the masonry skin and guards against air leakage when shrinkage occurs.



Type LAD

loft access door

- Fully finishes - ready to use
- Insulated fully removable door for easy access
- Integral resi-seals
- Provides uniform build quality and appearance

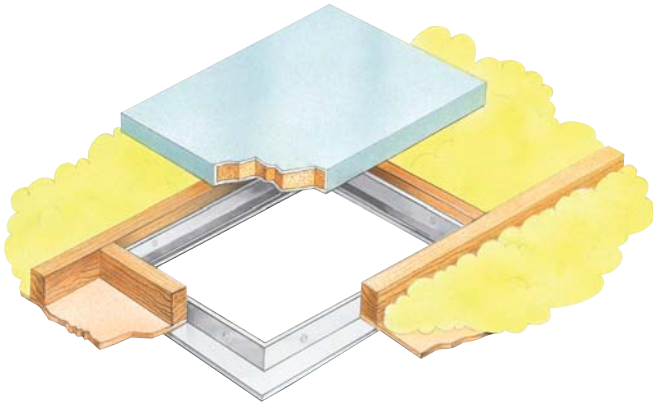

use

To gain access into roof space.

introduction

Prefabricated and self-finished insulated loft access door and frame. Can be fixed immediately between trimmed standard joists. The LAD loft access door and frame is supplied as a complete unit. It satisfies the contractor's total requirements in terms of aesthetics, finish, cost and stock control.

The white laminated door is fully removable, and is supported within a robust white PVC surround which may be directly fixed to standard trimmed joists. Within the surround are soft (draught) resi-seals which ensure the access door is correctly and completely accommodated.

As the lid is fully removable by lifting upwards, attic insulation can be cut and laid on top if required.

Zero ODP rigid urethane insulation offers thermally efficient performance as the core infill between composite foil facings applied to both sides of the urethane.

White-faced board is additionally laminated as the outer finish to the upper and lower faces of the removable door. Insulation thermal conductivity analysis given as 0.022-0.028 W/m.K. Incorporated within appropriate construction the insulation aggregate may be used to address part L requirements.

data

- Size 1 550mm x 750mm. (Trim to 555 x 775mm).
- Size 2 550mm x 550mm. (Trim to 555 x 555mm).
- White compound.
- A PVCU white laminated door with solid core of Insulation.
- Self-finished and ready to use.
- Insulated.
- Fully removable door on resi-seals.
- Available individually.

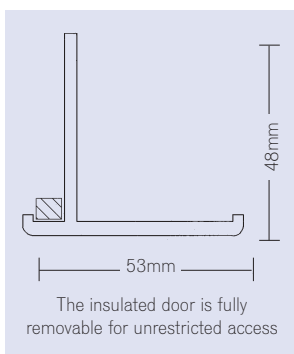

Downward Hinging Loft Access Door and Frame

- Ready finished
- Optional insulation upgrade
- Integral latch



use

Access into attic spaces.

introduction

Hinged downward opening loft access door for use where a door that can be fitted completely clear is not required. Available in one size only, the downward opening model requires a trimmed opening of approximately 566mm x 721mm. Made of lightweight PVCU and finished in white, the insulated door has an integral turn latch.

An optional ODP rigid urethane secondary layer can be supplied to

provide additional insulation to this model to increase thermal insulation performance and address part L target 0.022-0.028 W/m.K sampled typical analysis. Must be clearly specified as optional addition when ordering.

data

- Clear opening approx. 690mm x 535mm.
- Lightweight high impact polystyrene.
- White finish - requires no painting.
- Door contains provisional insulation.
- Available individually.

Type RBS

roof bonding strip for slates and tiles

- Links different roof finishes
- Pre-shaped for immediate use
- Lightweight and easy to handle
- Suitable for roof pitches from 10 degrees up to 60 degrees



use

To link and permit bonding of two dissimilar roof finishes.

introduction

There is a requirement to link and bond different roof finishes where they meet within a common slope. The Roof Bonding Strip is moulded with water-check ribs either side of a central mortar adhesion area.

Produced to an overall width of 230mm, the Type RBS is fire resistant in accordance with BS 476, the classification being to P60 (SAB) class three. It effectively creates an underlying bridge between abutting surfaces and may be used as part of a fire-break detail, as defined within the Building Regulations.

This product may normally be used on roof pitches from 10 degrees up to 60 degrees.

data

- Glass reinforced polyester.
- Colour lead grey.
- 230mm wide x 3000mm long.
- Pre-shaped for immediate use.
- Lightweight and easy to handle.
- Available individually.

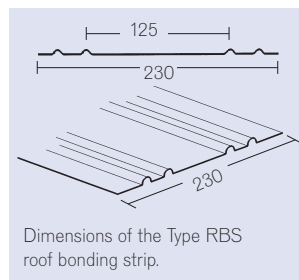

Type VG Valley Gutter

VG-S slate roofs VG-T tiled roofs

- Pre-shaped for immediate use
- Lightweight and easy to handle
- Traditional finish appearance
- Suitable for pitches 22 degrees to 60 degrees

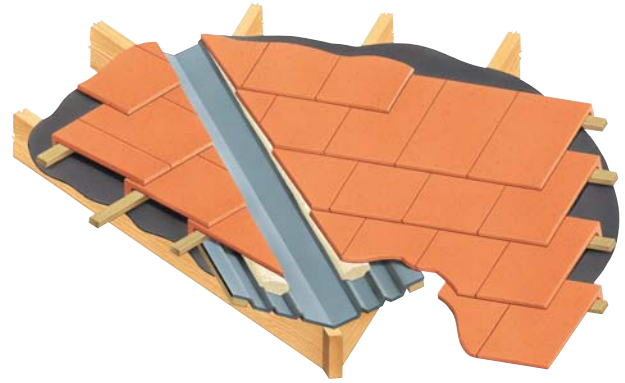

use

Weatherproof and waterproof preformed valleys.

introduction

Preformed Valley Gutters are manufactured from GRP and provide an alternative to the site fabricated lead valley. Two styles are available for use with slate roofs or tiled roofs. Both are finished with a tough bonded film coat which is coloured to resemble lead and provides excellent weathering qualities.

The Valley Gutter for tiles (VG-T) has integral water-check ribs to its sides and two sanded mortar adhesion strips. The Valley Gutter for slates (VG-S) is of a deeper profile. Both may be used to satisfy the requirements of roofs constructed to BS5534:Part 1:1990 (Slating & Tiling) and Part 6 of BS8000.

Type VG Valley Gutters are fire resistant in accordance with BS476, the classification to P60 (SAB) class three.

data

- GRP with film/gel coat.
- Available in lengths of 3 metres.
- Colour grey.
- Preformed profile.
- Integral water check ribs.
- For pitches down to 22 degrees.
- VG-S (slate) 330 x 300mm
- VG-SE (slate extra wide) 400 x 3000mm.
- VG-T (tile) 350 x 3000mm.
- Available in packs containing 10no.
- Smaller quantities available.

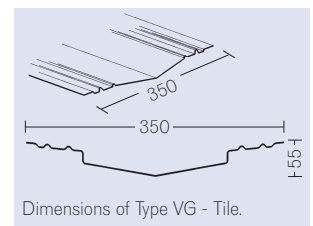
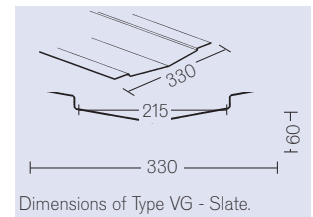

Siliconbond

silicon caulking compound

- Efficient pointing-in and sealing
- Absorbs thermal movement between materials
- Will not crack or absorb water
- Adhesion with elasticity

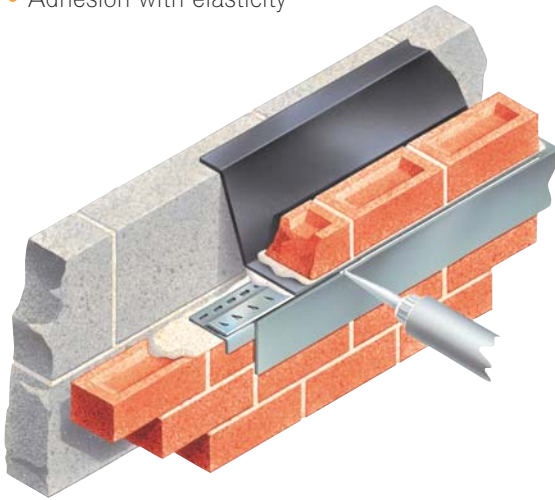

use

Caulking compound for pointing purposes where lead flashing is returned into mortar joints. Also suitable for sealing lead flashing, chase filling etc.

introduction

Silicon based one part caulking compound based upon a neutral curing system. Specific gravity approximately 1.12. Practical elongation 25%. Skin time 30 minutes. Cure time 3 to 6 days depending on temperature.

Note Preformed cavitytrays with attached lead flashings are conventionally flush-pointed when being built-in and do not

require siliconbond. This product is for applications where 'pointing in' is normally carried out at a later date. It may be used to address the recommendations of the Lead Sheet Association. Suitable for use with our Flashing Anchoring Strip (FAS).

data

- Clear/translucent finish harmonises with all mortar/masonry colours.
- Supplied in 310ml cartridges. (Shelf life six months.)
- One part cartridge applied system.
- Neutral and moisture curing.
- Absorbs thermal movement between lead and masonry.

Cavilinks

masonry attachment profiles

- Speedy linking of new and old masonry
- Lateral and longitudinal restraint
- Compatible with vertical integrity cavitytray
- Suits brickwork and block work

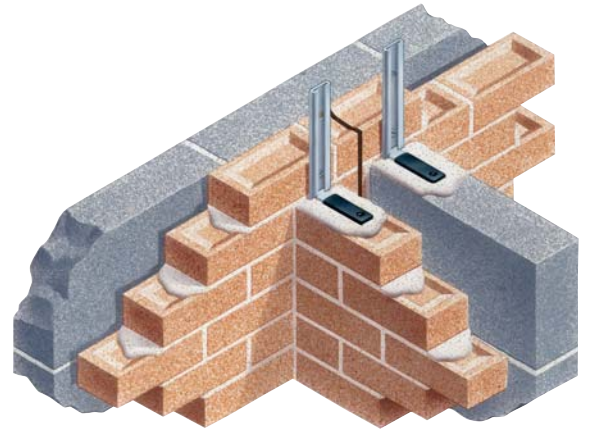

use

Provides fixing method of joining new masonry skin at right angles to existing masonry skin.

introduction

Masonry Attachments permit a new wall to be linked to an existing wall without cutting and keying the existing masonry. Each Masonry attachment accepts a single skin of standard thickness and is accompanied with ties that slide to harmonise with the requisite course levels.

Technically best practice dictates the new wall cavity runs into the existing wall cavity to maintain a void against damp

transmission. However a speedy alternative method of compliance using our Type B vertical cavitytray necessitates the cutting of a slot only.

data

- Material: stainless steel
- Each pack contains sufficient to tie-in one 2400mm high masonry skin.
- (2no lengths 42mm x 1200mm + 10no. ties + plugs and fixings).
- Accepts brickwork or block work.
- For wall widths from 60mm to 250mm.
- Suitable for most single and two storey applications.

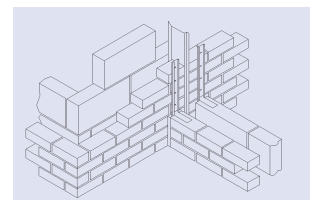
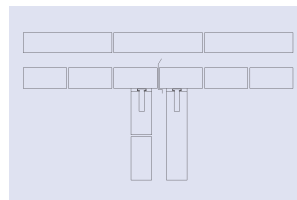

Specifying and Ordering

Our products are available through builders merchants. **Freephone** us on **0800 7311779** and we will be pleased to direct your order through an outlet servicing your area.

When specifying, state clearly **Cavity Trays of Yeovil** followed by the product details. This will help prevent substitution so you receive the products of your choice accompanied with our product performance liability protection.

Please see our main manual for standards references. Request your copy of the **Main Technical Manual Number 16**, for information on:

- Cavity Trays
- Flashings
- Membranes
- Cavity Closers
- Cavity Fire Stops
- Arches
- Undersill trays
- Common opening and lintel trays.
- Threshold trays
- DPC
- Pre-shaped damp courses
- Cloaks
- Parapet wall trays
- Sloping and horizontal gable abutment trays.
- Curved cavity trays
- Lead fabrications
- Masonry support trays and restraining straps
- Weeps
- Rain screen baffles
- Arresting barriers
- Stopends
- Flashing anchoring strips
- Gas / contaminated land protection

Contact information



telephone
01935 474769



fax
01935 428223



email
enquiries@cavitytrays.co.uk



web
www.cavitytrays.com



freephone help desk
0800 7311779

Cavity Trays Limited
Administration Centre
Yeovil Somerset BA22 8HU



Members of the Radon Council.

Our conditions of supply apply in all instances. A copy of the company's terms and conditions is available upon request. Cavity Trays Ltd shall not be liable for any consequential loss whether this arises from a breach of duty in contract or any other way. Quoted despatch dates and carriage methods apply to the anticipated date of dispatch and the anticipated mode of carriage only and speed shall not form any part of any contract. As part of our continuous product development, we reserve the right to amend or change specifications without notice.

enjoy the benefit of four generations of experience

In 1920 a West Country family of builders started making their own damp courses, flashings and cavitrays, the fourth generation of the same family continue the tradition. The Company is now called **Cavity Trays Ltd.**

The building envelope has ventilation requirements in addition to those of damp protection, and this publication lists the ventilation solutions available from Cavity Trays Ltd.

All are subject to the same stringent manufacturing qualities and are produced to a quality management system conforming with BSEN ISO 9001: 2000.

By clearly specifying Cavity Trays Ltd when selecting your ventilation choices as well as your damp protection choices, you will receive warranted products with accompanying product liability protection.

Cavity Trays 

Cavity Trays Limited
Administration Centre
Yeovil Somerset
BA22 8HU England
Telephone 01935 474769
Facsimile 01935 428223
www.cavitytrays.com

