

2000 Slide Switches - up to 5 position 10A 250Vac



- ▶ Slide switches
- ▶ Ratings up to 16A, 250V ac
- ▶ PCB and solder terminals
- ▶ 2, 3, 4 and 5 position
- ▶ Choice of circuits
- ▶ Choice of actuators

Approvals and specifications



10A 250Vac T85
6(3)A 250Vac T85



UL CSA 16A 250Vac Non Inductive
UL CSA 4A 300Vac
UL 65°C, file no. E45221, CSA file no. LR10990

µ contact gap

Please specify: Standard action (SP116) or Light action (SP118).
2000 series lubrication is inorganic and does not degrade plastics.

Technical data on pages 4 & 5.

T 2 2 20 5 C ---

TERMINAL SERIES POSITIONS CIRCUIT SLIDER BODY PRINT, COLOUR, ETC

slide switches

TERMINAL	SERIES	POS'N	CIRCUIT <small>Viewed from back</small>	SLIDER
<p>K</p> <p>2.8 x 0.8</p> <p>R</p> <p>2.8 x 0.8</p> <p>T</p> <p>Solder</p> <p>X</p> <p>PCB 0.8 Sq.</p> <p>Y</p> <p>PCB 0.8 Sq. For mounting stability switches have extra "support" terminals</p> <p>* Nominal - Dimension varies with body type. For exact figure call sales</p>	2	2 Switching positions	10	0
			20	6
			30	D
			40	L
		3 Switching positions	10	1
			20	7
			30	E
			40	N
		4 Switching positions	10	2
			20	9
			30	G
			40	P
5 Switching positions	10	3		
	20	A		
	30	H		
	40	R		
5 Switching positions	10	4		
	20	B		
	30	J		
	40	S		
5 Switching positions	10	5		
	20	C		
	30	K		
	40	T		



X22205C ---



T2220EC ---



T23206A ---



T24306A ---



T25302A ---



T25100A ---

BODY

C 2 positions

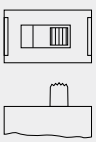

H 2 positions

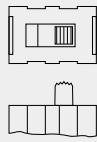

A 3 positions

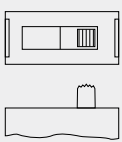

H 3 positions

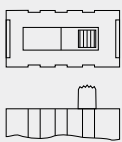

A 4 positions

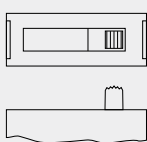

H 4 positions

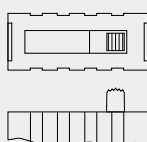

A 5 positions

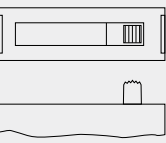

OPTIONS

Colour

For custom slider colours call sales. A full range is available for large orders

DIMENSIONS (mm)

2 Position C body

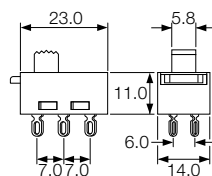

2 Position H body

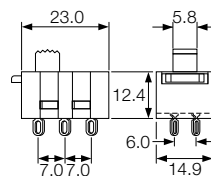

Cut-out/PCB Matrix

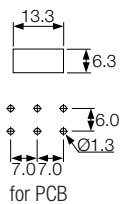

3 Position A body

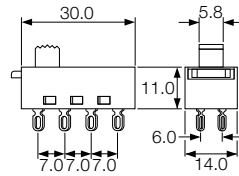

3 Position H body

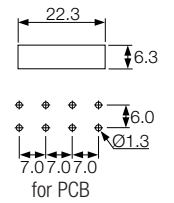
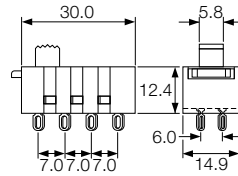

4 Position A body

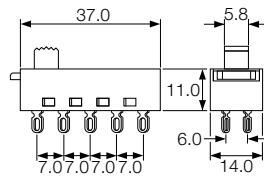

4 Position H body

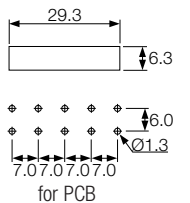
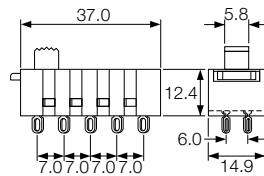

5 Position A body

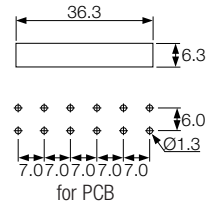
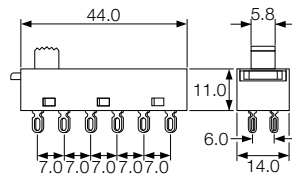

2000 Slide Switches - Snap fit and panel mount 10A 250Vac

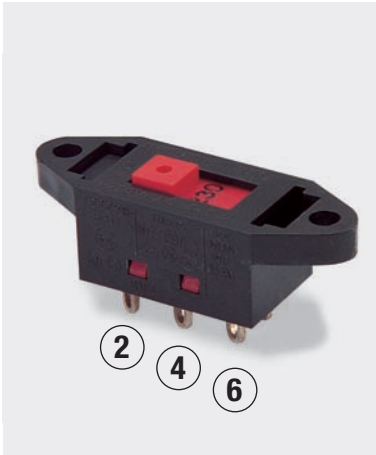

- ▶ 2 way 'voltage selector'
- ▶ Ratings up to 16A, 250V ac
- ▶ Snap fit and panel mount
- ▶ PCB & solder terminals
- ▶ 2 and 3 position
- ▶ Choice of circuits
- ▶ Choice of actuators

Approvals and specifications



10 A 250Vac T85
6(3)A 250Vac T85



UL CSA 16A 250Vac Non Inductive
UL CSA 4A 300Vac
UL 65°C, file no. E45221, CSA file no. LR10990

µ contact gap

Please specify: Standard action (SP116) or light action (SP118).
2000 series lubrication is inorganic and does not degrade plastics.

Technical data on pages 4 & 5.

115/230 is preferred legend

T 2 2 20 5 B ---

TERMINAL SERIES POSITIONS CIRCUIT SLIDER BODY PRINT, COLOUR, ETC

TERMINAL	SERIES	POS'N	CIRCUIT <small>Viewed from back</small>	SLIDER				
K 2.8 x 0.8	2	Switching positions	10	0	6	C	L	S
			20	2	7	D	M	T
			30	3	8	E	N	
			40	4	9	H	P	
R 2.8 x 0.8	2	Switching positions	10	5	A	K	R	
			20	6				
			30	7				
			40	8				
T Solder	2	Switching positions	10	9				
			20					
			30					
			40					
X PCB 0.8 Sq. For mounting stability switches have extra "support" terminals * Nominal - Dimension varies with body type. For exact figure call sales	3	Switching positions	10	10				
			20					
			30					
			40					

slide switches



T22208E ---



T22308E ---



T2230MF ---



T22205B ---



T22305B ---



T23204B ---

BODY

OPTIONS

B With mounting holes

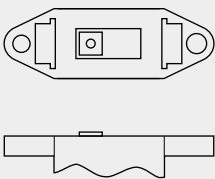

Colour

For custom slider colours call sales. A full range is available for large orders

Standard body colour is black

Legend printing

A wide range is available

E Snap fit

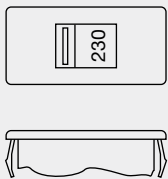

Cut-outs must be punched in the direction of insertion

For all options call sales

F Snap fit (single pole ON OFF only)

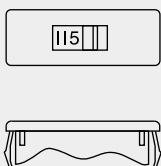

Cut-outs must be punched in the direction of insertion

DIMENSIONS (mm)

Cut-out / PCB Matrix

2 Pos B

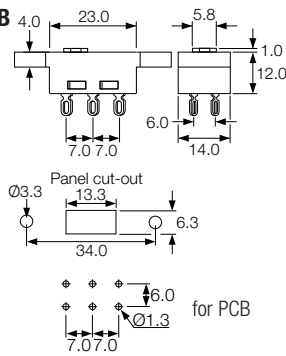

3 Pos B

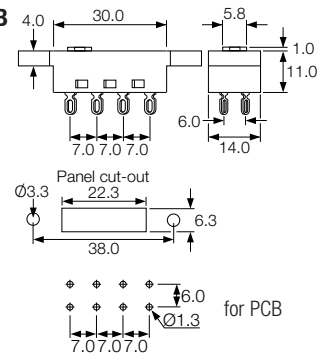

2 Pos E

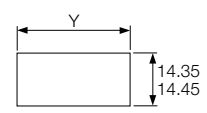
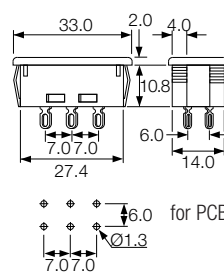

Panel thickness	Dim. Y
0.8-1.2	29.75/29.85
1.63	30.15/30.25
2.0	30.35/30.45
2.5	30.55/30.65

2 Pos F

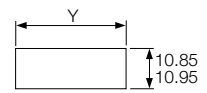
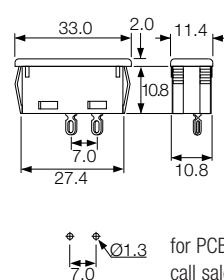

Panel thickness	Dim. Y
0.8-1.2	29.75/29.85
1.63	30.15/30.25
2.0	30.35/30.45
2.5	30.55/30.65

slide switches