

Bulk Bag Filling

Dust-free filling and weighing of
Bulk Bags, Rigid Bins, Drums and IBCs

Bulk Bag Weigh Fillers

DESIGNED FOR VERSATILITY. BUILT FOR ADAPTABILITY.

Over 100 million bulk bags are sold each year worldwide, proving they are now a well established form of packaging, storage and transport - and not just from an economic standpoint.

Processors now have a viable alternative to handling and disposing of large numbers of dusty 25kg sacks, because Spiroflow equipment makes filling and discharging from bulk bags safer, easier, more controllable, and dust-free. Continuous development of our filling stations allows the choice of standard or customized equipment to suit access, height or hazard considerations. Our filling stations are also the most versatile on the market - they can be adapted for use with rigid bins, drums and IBCs.

Customers using our filling stations cover applications in the food, dairy, chemicals, pharmaceuticals, plastics, building products and minerals industries. In addition to standard features including bag/liner inflation and inflatable neck seal, a wide range of optional equipment is available to satisfy process requirements such as spinner filling heads, vibratory bases for bag compaction, automatic bag removal, pallet dispensers and take-off conveyors.



Filling materials in Bulk Bags and 25kg sacks in a minerals processing plant.



Automatic bag loop release.



Handling by pallet.

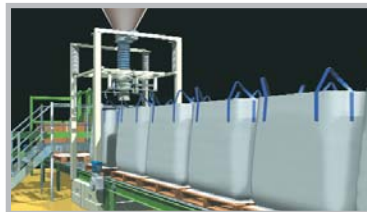

Semi-automated bulk bag filling system.



Handling by loops.

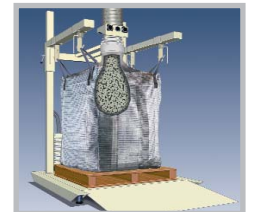

Low profile filler.

Determining Your Requirements

Before selecting a particular weigh filler, some key factors need to be considered. This not only helps to assess a customer's own particular needs, but also assists our design engineers in determining the optimum system for those needs.

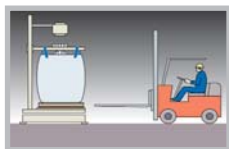

Q. How do we handle the bulk bag?
A. By pallet or by the bag loops.

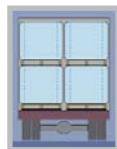

Q. What bag style and size do we use?
A. At this stage, you should consult both the bag manufacturer and Spiroflow. The bag needs to optimize all its volume for safe storage and transport.
**See 'IBC Filling and Selection' in the Brochures section of our website.*



Q. How do we contain dust?
A. An inflatable neck seal effectively contains the dust during filling. All our filling heads comprise an inner and outer annulus, for product flow and dust evacuation respectively.



Q. Can the filling system be automated?
A. If filling in volume, options such as pallet dispensers, automatic bag loop release, bag take-off and accumulation conveyors should be considered, and can be added at a future date to standard Spiroflow equipment.



Q. Will the equipment need to be grounded?
A. If the area poses an explosion risk, static dissipative or groundable bags may be recommended, together with a suitable static monitoring device.

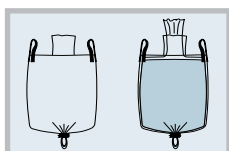

Q. Do we need a bag liner?
A. If the product is very fine, you probably will, to prevent leakage or moisture ingress. However, various alternatives can be used such as coated bags or special bag seams. The liner must be inflated correctly to avoid creasing and subsequent discharge problems.

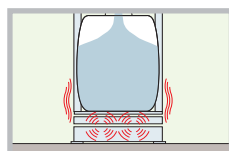

Q. Does the product need vibration?
A. Usually, yes. Vibration at the base of the unit deaerates and compacts the product so it not only optimises the bag volume, but forms a safe and stable load. A spinner head can also be used to disperse product into 'baffle' or compartmentalized bags.



Q. Is automatic loop release and height adjustment available?
A. Yes, automatic loop release of filled bags is a useful labor saving option for pallet loaded bags. Powered height adjustment is also recommended if different sizes of bag are being filled in order to speed up the filling process.

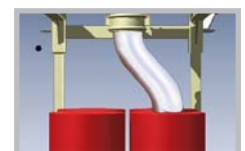

Q. Can the equipment be adapted to fill other types of container?
A. Yes. Spiroflow supplies a range of options for the filling of rigid bins, drums and octabins and gayloads.

C Series Features and Options

C SERIES WEIGHT FILLERS FOR PALLET HANDLED BAGS

The competitively priced C Series fillers are the ideal solution for users with low to medium volume requirements.

The modular construction of the C Series enables users to specify a basic unit for their initial requirements. Where future production demands determine the need for additional operational features, a full range of options is available designed to meet particular system requirements.



Standard Features

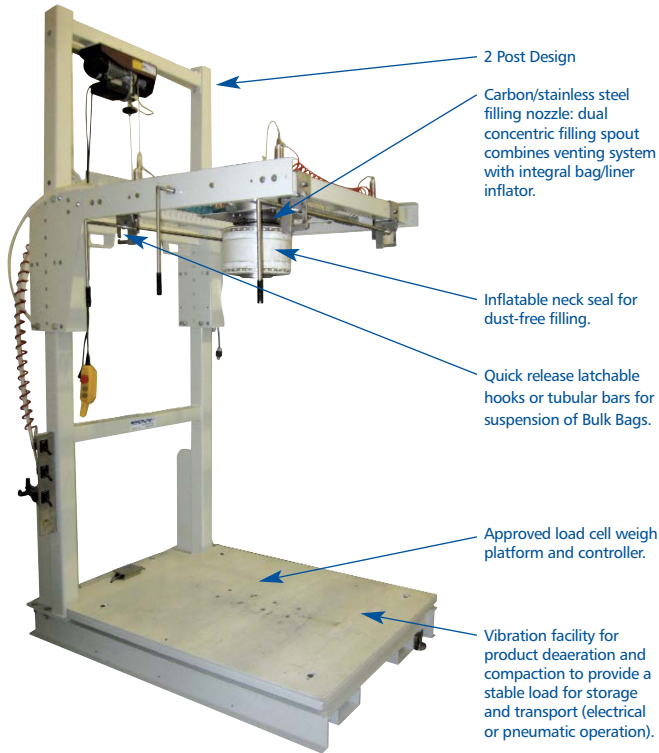

The C1 Model is for use where Bulk Bags are filled on pallets and removed by fork lift truck. The base is directly mounted on an approved load cell weigh platform. Features include stop/start control by set weight, vibration for product compaction, pneumatic neck seal and venting for the air that is displaced during filling.

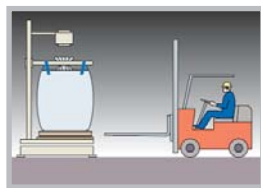

Options

Model C3 with automatic height adjustment for varying bag sizes and pneumatic bag loop release system.



Automatic bag loop release.



- Powered roller, mesh or belt conveyor for easy removal of Bulk Bags.
- Pneumatic bag push-off device.
- Full management data on weight controller, plus printer.
- Pneumatic bag loop release system.
- Rigid bin or drum filling attachment.
- Automatic Bulk Bag height adjustment
- Access platform.
- Full range of filling valves to suit product.
- Spinning heads, to distribute product in bag.
- Mobile units.

Technical Data: Dimensions may vary according to bag size.

Height	2800 mm
Width	1510 mm + 350 mm for control panel
Depth	1510 mm
Fill rate (depending on Bulk Bag size, feed method and operator availability)	Up to 20 Bulk Bags / hour
Air requirements (inflatable neck seal and Bulk Bag inflator) NB: Valve requirements not included	5.5 bar @ 900 litres per cycle

LC Series Features and Options

LC SERIES WEIGH FILLERS FOR LOOP HANDLED BAGS

The heavy duty LC Series is designed for users who need a heavy duty filling rig that enables the bag to be easily removed by the loops - for instance, cement and minerals plants.

Rise and fall loop support arms with fork lift truck channels accommodate various bag sizes, and allow the quick and easy removal of the bags by the loops. Options apply as with the standard C Series machines.



Standard Features

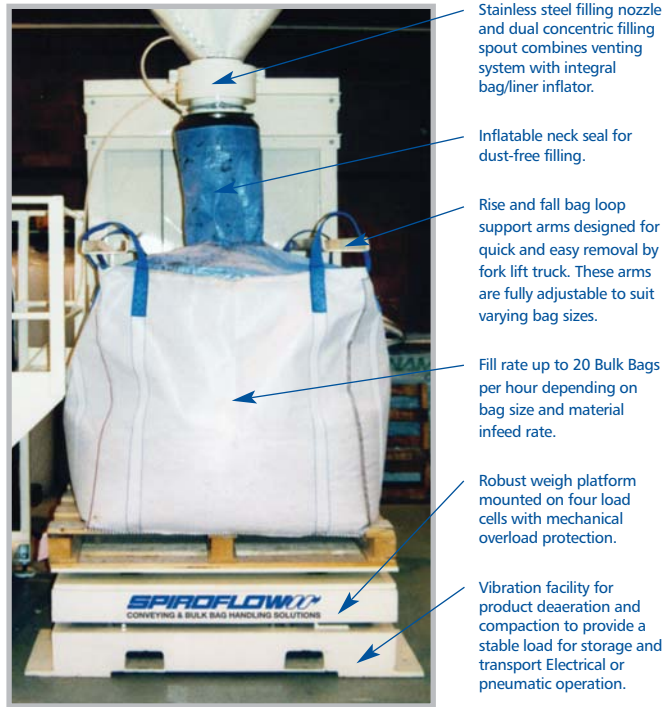

Stainless steel filling nozzle and dual concentric filling spout combines venting system with integral bag/liner inflator.

Inflatable neck seal for dust-free filling.

Rise and fall bag loop support arms designed for quick and easy removal by fork lift truck. These arms are fully adjustable to suit varying bag sizes.

Fill rate up to 20 Bulk Bags per hour depending on bag size and material infeed rate.

Robust weigh platform mounted on four load cells with mechanical overload protection.

Vibration facility for product deaeration and compaction to provide a stable load for storage and transport Electrical or pneumatic operation.

The LC series is robustly built for heavy duty operation and dust-free filling. Depending on material in-feed rate and bag size, the LC Series can fill up to 20 bags an hour. Product filling can be enhanced by way of a spinner below the filling head and deaeration is provided by vibration through the base of the filler. An ingenious mechanism raises the bag support arms as the bag is lifted by its loops to ensure adequate clearance underneath the filled bag to ensure its safe and efficient removal. We have a Data Sheet that gives the full details.

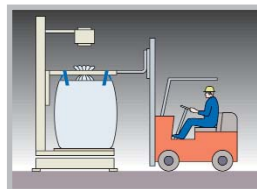

Options

Optional equipment includes attachment for rigid and drum filling and data management on weight controller.

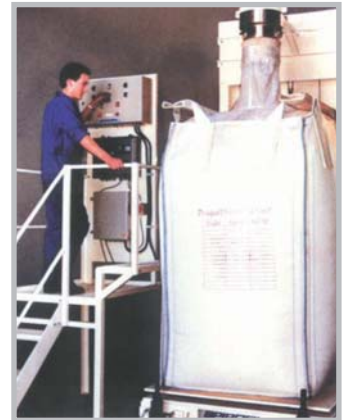

A wide range of bag sizes can be used for filling a variety of products.

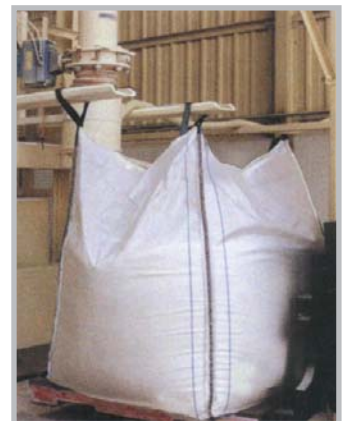

- Full management data on weight controller, plus printer.
- Rigid bin or drum filling attachment.
- Access platform.
- Hazard area specification.
- Full range of filling valves.

Technical Data:

Height	2600-3400 mm dependent on size of bulk bag
Width	1200 mm
Depth	1500 mm
Fill rate (depending on Bulk Bag size, feed method and operator availability)	Up to 20 Bulk Bags / hour
Air requirements (inflatable neck seal and Bulk Bag inflator) NB: Valve requirements not included	5.5 bar @ 900 litres per cycle

Models for Special Applications

LOW LOADER • BULK BAGS AND/OR SACKS • BULK BAGS OR IBCS OR DRUMS

In addition to our standard ranges of weigh fillers, at Spiroflow we design and manufacture special purpose equipment for many different tasks.

Low Loader



When filled, the bag is removed by pallet jack.

Spiroflow's low loader means bulk bags can now be removed **without the need for a forklift**. The low loading ramp and low profile pallet base makes unloading filled bulk bags a simple task with a pallet jack.

Bulk Bags and/or Sacks



Filling system for bulk bags and 25kg sacks.

Bulk Bags, IBCs or Drums



Processors need to respond quickly to customer demand and be able to supply product in other kinds of containers such as rigid IBCs, drums, octabins and IBCs. With the addition of special adaptors, this can be achieved using the same filling platform, providing a versatile, multi-purpose machine.

No Job Too Big



36,000 tonnes in 27,000 Bulk Bags in Alaska, in 14 weeks!
2 Fillers delivered and operational in 6 weeks.

Sample Frames



Volumetric filling of dust-free, free flowing, granular materials.

Complete Systems



This is where we excel. We take care of everything from concept to commissioning the installed system.

Semi-automated Filling

Semi-automated bulk bag filling system gives large volume users the benefit of continuous operation without having to stop to unload each bag. Pallets are automatically fed to the filling rig and the bags are looped onto pneumatically operated hooks. Once filling is completed, the loops are automatically released and the bag is then moved along the line by a powered take-off conveyor.

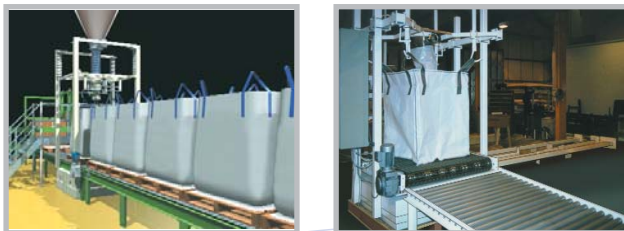

Custom Bags

Bring us your challenges, we are always willing to design and manufacture fillers to meet the specific needs of individual customers.



Accurate Filling

For the most accurate of fillers, we offer 'hang-weighing' which can be accurate up to +/- 20gm.



Filling Equipment and Systems Designed to meet all Process Requirements

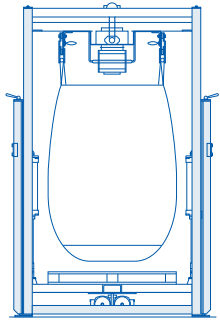

Hang weighing bulk bag filler.

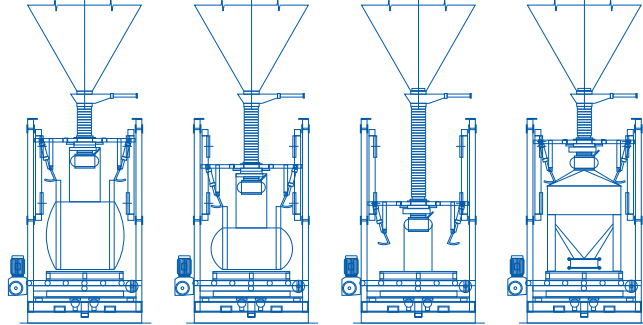

Filling station for FIBCs, drums and rigid bins.

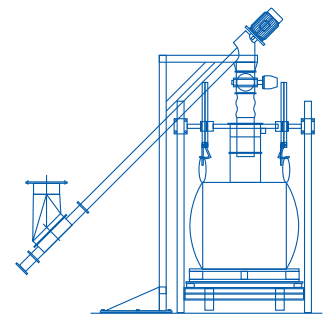

C Series bag filler with feed conveyor.

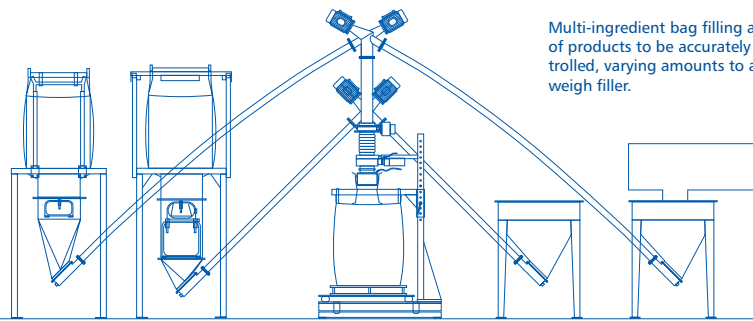

Multi-ingredient bag filling allows a number of products to be accurately fed in controlled, varying amounts to a Spiroflow weigh filler.

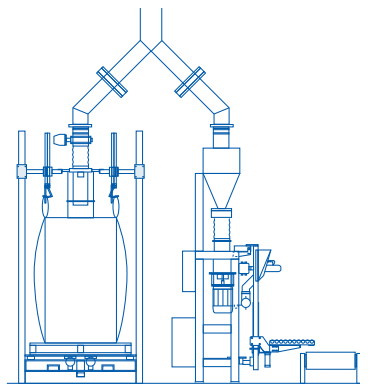

C1 Series bag filler and 25kg 'turbo' valve packer fed from one source via bifurcated chute.

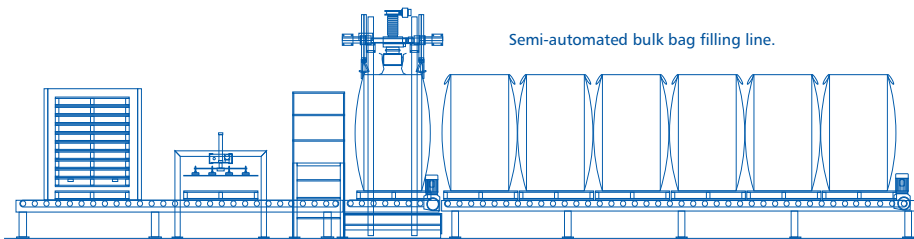

Semi-automated bulk bag filling line.

Pallet dispenser.

Slip sheet dispenser.

Access platform.

Powered accumulation conveyor.

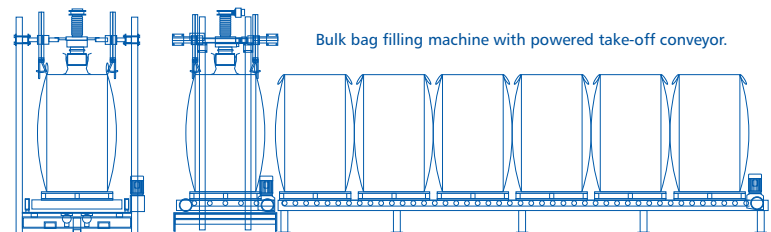

Bulk bag filling machine with powered take-off conveyor.

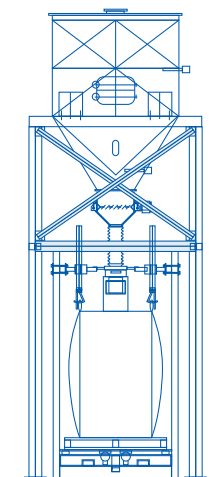

Filling machine fed direct from silo or process vessel via bin activator.

Filling Fragile Materials



1

The bottom of the bag is raised up to the filling head to avoid fragile products having to fall the height of an empty bag.



2



3



4

As the bag fills, material flow is regulated by its natural 'choking' action and the base of the bag is lowered at a rate that allows filling without product damage.

Correctly Filled Bags

Correctly filled bags, safe for handling, transportation and storage.



Bulk Bag Filling - Sequence of Operation



1. Bag loops are placed over support arms.



2. Bag spout and liner are opened up.

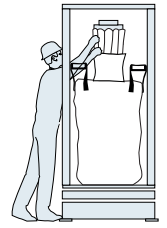

3. Liner or bag spout is attached to inflatable neck seal.

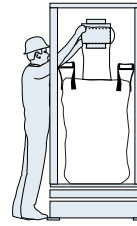

4. Neck seal is inflated to secure the liner or bag spout during filling.

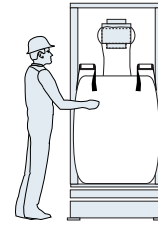

5. Liner/bag inflated.

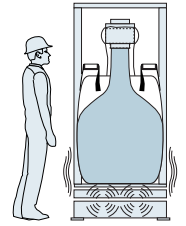

6. Vibration during filling.

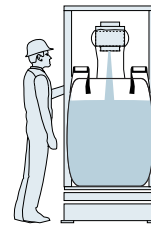

7. Filling valve closes at target weight.



8. Bulk bag spout removed from filling nozzle and tied.

Inflating a Bag Liner Correctly

Wrong

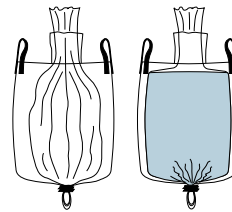

Bulk bag liner, loose as bag supplied.

Bulk bag filled with product, but due to creased liner is rucked over outlet and could give discharge trouble.

Right

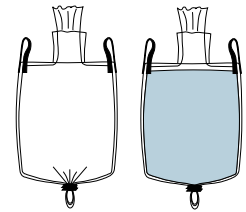

Correctly inflated liner so no rucking occurs in bulk bag or over outlet spout.

Correctly filled bulk bag with no rucking in liner and over outlet spout.

Powder Handling Systems

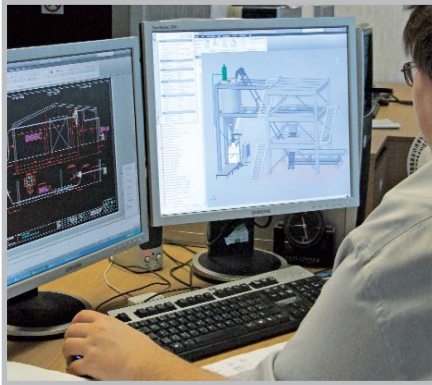

Design

We have an experienced team of mechanical and electrical engineers with a vast collective knowledge of solids handling, geared to handle your project quickly and efficiently, whether you need a single filling station or a complete powder handling system.

Testing

Our fully equipped test facility, which is at your disposal, assesses performance of our machinery on your particular material. On-site trials can also be arranged if preferred.

Manufacturing

We actively encourage customers to visit our modern manufacturing facility at any time. Here, we are able to process orders efficiently and to our high standards. We also have a similar manufacturing facility in the USA. Our systems and procedures have ISO9001:2000 accreditation.

After sales

At Spiroflow, we firmly believe that after sales service forms an integral part of the product. Over 70% of our business comes from existing customers, whom we work with as partners from the moment of placing an order and throughout the equipment's operational life.

Other equipment in the Spiroflow Range:

- Flexible Screw Conveyors
- Aero Mechanical Conveyors
- Tubular Drag Conveyors
- Pneumatic and Vacuum Conveyors
- Bulk Bag Dischargers
- Bag, Drum and IBC Emptiers
- Ingredients Handling Systems
- Batch and Continuous Weighing Systems
- Silo and Hopper Discharge Aids
- Continuous Mixing Systems



Flexible Screw Conveyors



Aero Mechanical Conveyors



Tubular Drag Conveyors



Vacuum Conveyors



Bulk Bag Dischargers

Contact us today to discuss your applications

SPIROFLOW
CONVEYING & BULK BAG HANDLING SOLUTIONS



Spiroflow Limited
Lincoln Way, Clitheroe,
Lancashire, BB7 1QG, UK.

Telephone: +44 (0) 1200 422525
Facsimile: +44 (0) 1200 429165
Email: sales@spiroflow.com
Website: www.spiroflow.com

Spiroflow Systems Inc.
2806 Gray Fox Road, Monroe,
NC 28110, USA.

Telephone: (1) 704 291 9595
Facsimile: (1) 704 291 9594
Email: info@spiroflowsystems.com
Website: www.spiroflowsystems.com



Designed and produced by CDM
10/2010 Edition