



**Aero Mechanical  
Conveyors**  
for dry bulk solids and ingredients

# Conveying Solutions

## FOR DRY BULK SOLIDS AND INGREDIENTS

Spiroflow is internationally recognised as a leading name in the provision of conveying solutions for applications associated with dry bulk solids - whether in powder, granule, flake, pellet, lump or whatever form and whether in bulk quantities or as minor additives / ingredients.

The company was founded nearly 40 years ago with the Flexible Screw Conveyor as its cornerstone and with which the name Spiroflow has become synonymous.

We aim to offer our customers the best solution, we have never believed in the 'one size fits all' philosophy. Accordingly, as we have expanded our horizons, we have developed our conveying ranges to meet the new challenges whether organically, by strategic acquisitions or through joint ventures. As a result, today, we offer the following types of conveyors:

- Flexible Screw Conveyors
- Aero Mechanical Conveyors
- Positive Pressure and Vacuum Pneumatic Conveyors
- Cable and Chain Driven Tubular Drag Conveyors

For nearly 40 years, we have designed, engineered and continuously developed our line of equipment and systems to effectively handle the enormous diversity of products to be found within today's process industries. Time and again, in food and pharmaceuticals, cosmetics and chemicals, minerals and plastics, our proven experience has enabled us to provide solutions to meet every handling need. Our conveying systems are designed with a minimum of working parts for maximum reliability. They are simple to operate, easy to clean and maintain, and are dust-free in operation.

This brochure describes our range of Aero Mechanical Conveyors.

# Aero Mechanical Conveyors

## Principle of operation

Our aero mechanical conveyors are of a tubular design in which a continuous wire rope assembly with accurately spaced polyurethane discs move at high speed. At each end of the conveyor, the rope assembly runs around specially designed sprockets, one of which drives the rope assembly and the other tensions it. The drive assembly can be located at either the inlet or outlet of the conveyor depending on its length or to suit plant requirements.

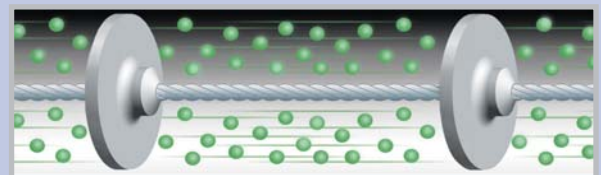
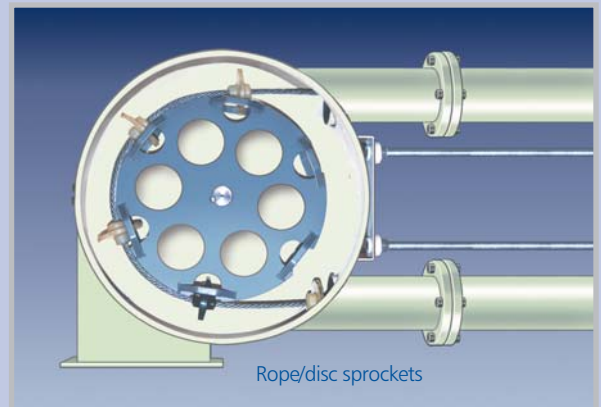
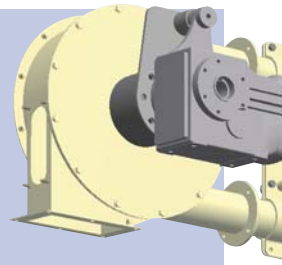

The action of the rope and disc assembly travelling at high speed sets up an airstream running at the same velocity. As material is fed into the airstream, it is fluidised and conveyed to the outlet where it is centrifugally ejected. High capacities are possible with low energy requirements and with minimal product degradation and separation.

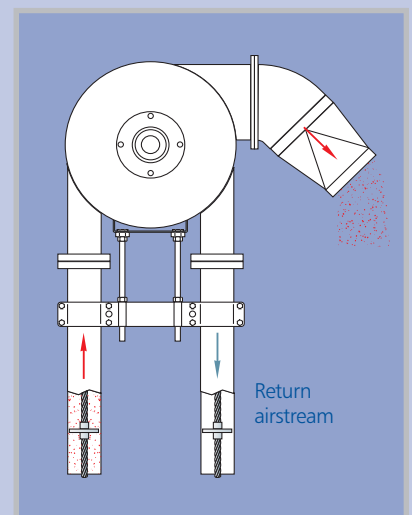

# The Benefits

## No dust collection system

Because no additional air is added to convey materials in an aero mechanical conveyor, there is no excess air at the outlet from which to filter entrained dust. Any entrained material that is not ejected at the outlet is simply carried round the enclosed system until it is.

## Low power consumption

Kilogram for kilogram conveyed, the aero mechanical conveyor is one of the most efficient. Therefore, keeping power requirements and costs to a minimum.

## Total transfer

We would be deluding ourselves as well as our customers to claim 'total transfer'. Of course, as in any other conveyor or vessel, fine powders will adhere to the walls of the conveying tubes to one degree or another BUT, for all intents and purposes, for everyday bulk solids and ingredients handling applications; what is feed into the conveyor at the inlet is discharged at the outlet. This makes the aero mechanical conveyor ideal for transferring pre-weighed batches of bulk and/or minor ingredients.

## Gentle conveying action

Materials are suspended in a cushion of air that lines the walls of the conveying tubes as it is displaced by the discs travelling at speed. This makes for a gentle conveying action that minimises damage to fragile finished products as they are conveyed to packaging machines, for example.

## Totally enclosed

All conveying takes place in a totally sealed tubular system which ensures the dust-free transfer of even the finest of powders.

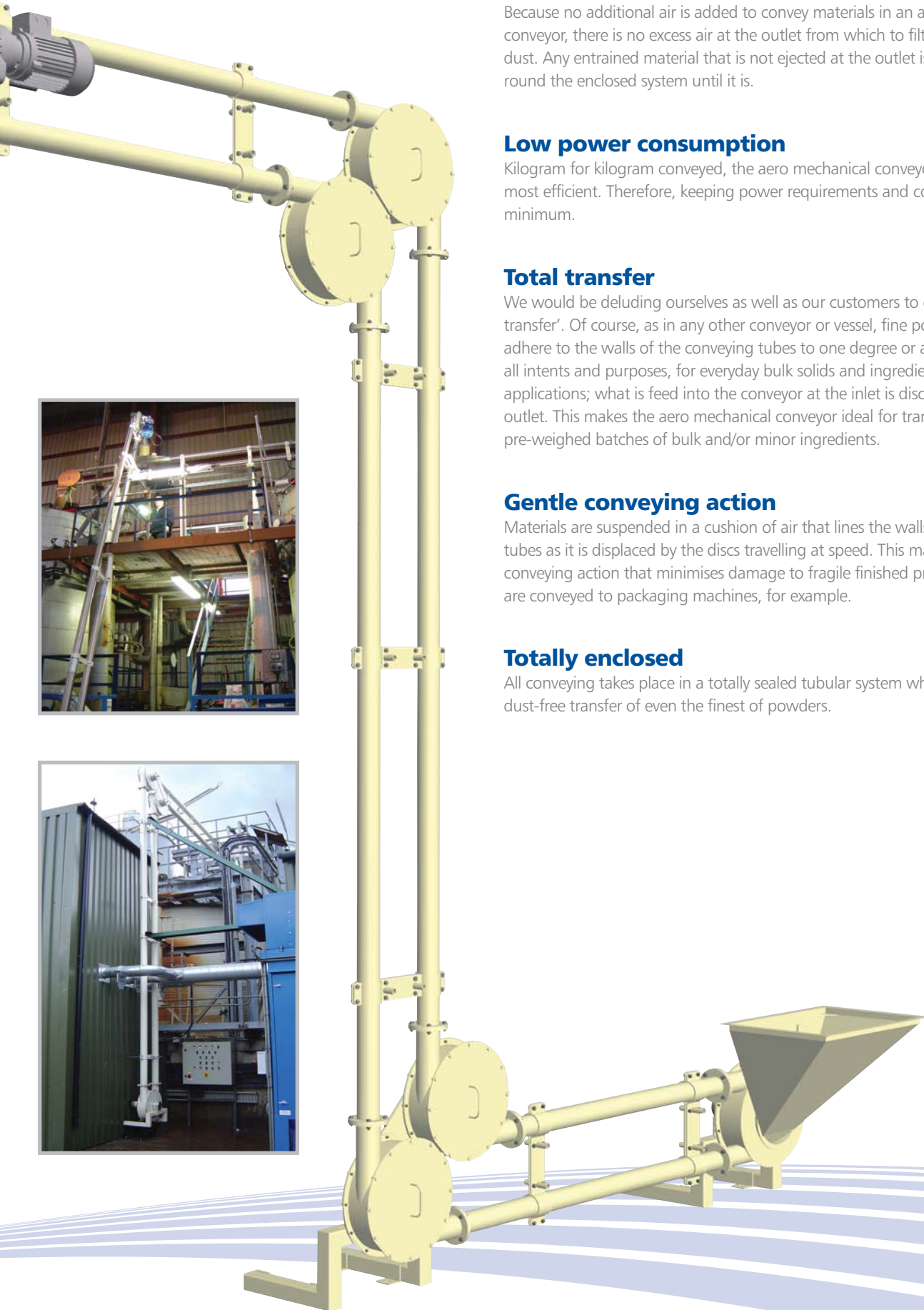

# More Benefits

## Operates at any angle

One of the most significant features of the aero mechanical conveying concept is its ability to convey materials between 0° and 90° without any loss of capacity.

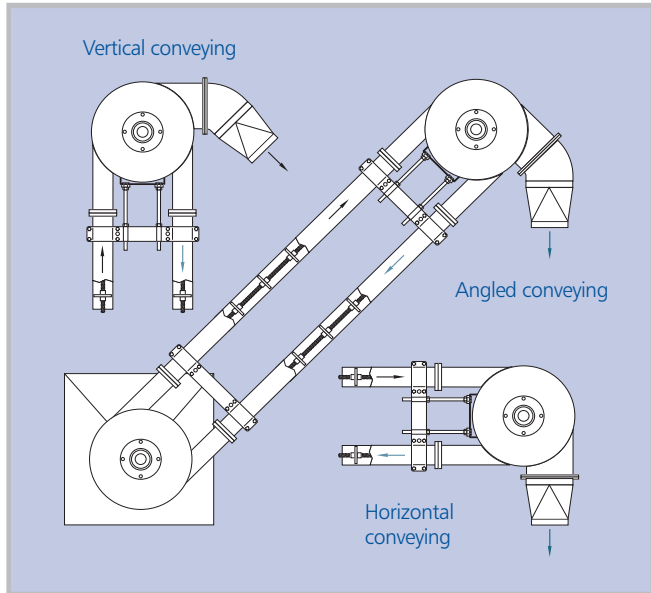

## Multiple inlets and outlets

The concept lends itself to multiple outlets so that one conveyor can deliver material to a series of silos for example. Multiple inlets are possible too provided they are operational one at a time.



## Goes around corners

Aero mechanical conveyors can be supplied in a variety of configurations enabling them to transfer materials vertically and horizontally within the same unit.

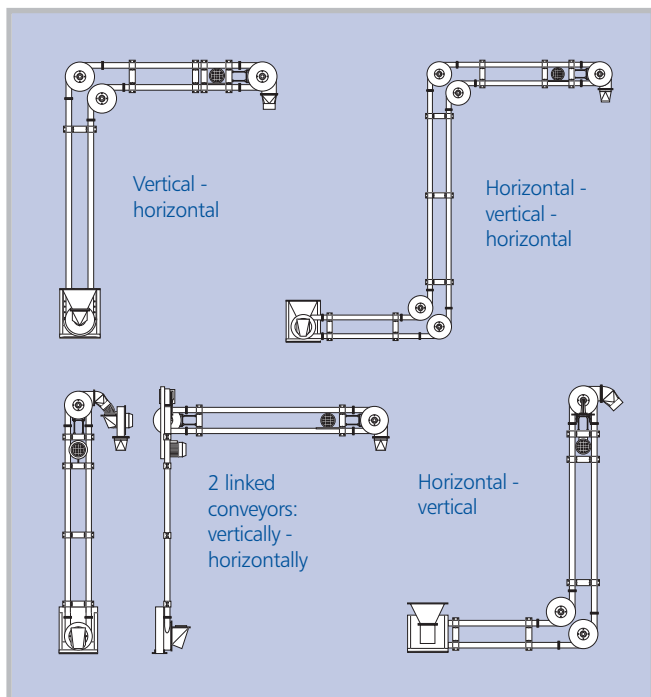

## Mobile

'Spiroflow' Aero Mechanical Conveyors can readily be mounted on a wheeled frame complete with controls and an umbilical power connection. This makes it possible to use one conveyor to serve several processes or to remove it to a remote wash-down area, away from production, for cleaning. Where mobile units have to pass under low beams or doorways, optional height adjustment can be included too.



With simple sack tip hopper for non-dusty materials.



With sack tip hopper and integral dust hood.

With height adjustment.



# Outstanding Performance

## Conveys difficult materials

Virtually all materials can be conveyed in an aero mechanical conveyor ranging from the finest of powders to granules, pellets, flakes and flocks. We have been particularly successful with Titanium Dioxide which is notoriously difficult.



## Maintains mixtures

Given that product is metered into aero mechanical conveyors at a controlled rate, there are almost identical amounts in each pocket between the discs. The conveying action itself is gentle and therefore tends not to disturb mixtures. The combination of these two factors means that the integrity of mixtures is maintained during conveying.

## Cleaning

Because of the 'total' transfer capability of aero mechanical conveyors, for most applications, cleaning is not necessary. To avoid cross-contamination between colours or flavourings for example, simply purging with a sacrificial quantity of material is often enough. Safety interlocked cleaning/ inspection hatches can be fitted to both the conveying tubes and the sprocket housings. However, aero mechanical conveyors fitted with suitable drain cocks can be washed through with water or other cleaning fluid - provided that they are allowed to run empty until thoroughly dried by the air circulating through them. This drying process can be speeded up by applying warm air.



Interlocked inspection hatch in sprocket housing.

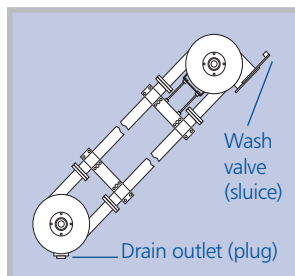

## Typical throughputs

The table below shows estimated 'Spiroflow' Aero Mechanical Conveyor rates in tonnes per hour based on continuously metered feed. When feeding from a bag dump, the rate may reduce by 10% - 40% depending on the material flow characteristics.

Product	Model		
	PC3	PC4	PC5
Barley	16	33	66
Carbon black	6	12	24
Coffee Beans	6	12	24
Desiccated Coconut	3	6	12
Fiberglass	7	14	28
Flour	6	12	24
Gypsum	15	30	60
Iron Powder	10	20	40
Lime-hydrated	5	10	20
Milk Powder	5	10	20
Oats	10	20	40
Polyethylene	12	24	48
PVC pellets	10	20	40
PVC powder	13	26	52
Sand	24	48	96
Sodium carbonate	9	18	36
Sugar (granulated)	20	40	80
Tea	6	12	24
Titanium Dioxide	5	10	20
Wheat	33	66	132
Zinc Oxide	6	12	24

Model	PC3	PC4	PC5
Tube size (OD) mm	75	100	125
Particle size mm (max)	10	15	15
Conveyor length (metres) max Vertical	15	15	15
Horizontal	20	20	20
Cornered	12	12	12
Rope speed (metres per min)	228	305	365

# Construction

Construction can be of epoxy painted carbon steel or a grade of stainless steel to suit the application. Conveying ropes are either of carbon or stainless steel with discs of food grade polyurethane.



Carbon steel construction.

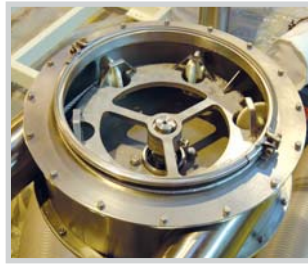

Stainless steel construction.



Standard disc material is USDA accepted polyurethane.



We are well versed in the ATEX/DSEAR regulations relating to the risks of machinery and electrical equipment operating in potentially explosive atmospheres. We have the capabilities to design and manufacture both machines and control panels to comply.

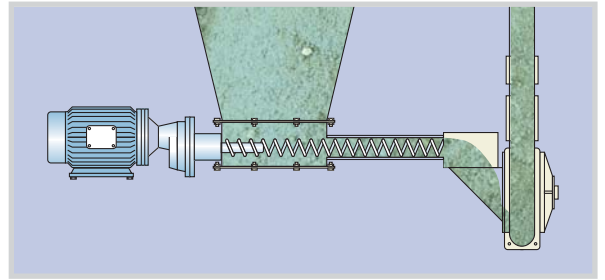

When the headroom is very low, a screw conveyor can be used to deliver material to the chute of the aero mechanical conveyor.



Many aero mechanical conveyors are fed from bulk bags. Spiroflow is well placed to supply appropriate Bulk Bag Dischargers to suit.

# Accessories



In sack emptying operations, a ▲ dust hood is often necessary. ▲ A sack compaction device may also be supplied.



Inlet chute with aeration device.



Pneumatic baffle provides control of flow into conveyor (free flowing materials only).

As with all conveyor systems, routine maintenance reduces breakdowns and wear on machines. Two new patented devices are now available for 'Spiroflow' Aero Mechanical Conveyors to ensure smooth and trouble-free operation. Extensive trials have shown that rope life can be increased by up to 40% by use of these devices. Choice of unit depends on length of conveyor, usage and type of product being conveyed.



Automatic rope tensioner.

- Rope tension monitor - alerts user to need for rope tensioning.
- Automatic monitoring and tensioning device.

# Applications

Consistent performance and operational reliability have endeared aero mechanical conveyors to a broad cross-section of industries. From the seemingly simple task of transferring food ingredients to the conveying of abrasive and corrosive chemicals, aero mechanical conveyors (AMCs) are well equipped to handle most materials with ease.



Round the corner AMC feeding chemicals to a mixing vessel.



Inclined and horizontal AMCs feeding additives to either of 2 tanks.



AMC elevating material from a transition hopper fed by two bulk bag dischargers via spiral conveyors.



An AMC transferring flavoured coffee powder from a blender up to a packing machine.



AMC designed for handling titanium dioxide. The aero mechanical conveyor is the only effective method of handling this type of product.



2 AMCs delivering tin oxide from process to packaging.



An AMC with multiple inlets delivering cement, sand, ash and recycled glass to a second unit that lifts them up into a mixer.



Bulk bag discharger and AMC loading road tanker.

# Powder Handling Systems



## Design

We have an experienced team of mechanical and electrical engineers with a vast collective knowledge of solids handling, geared to handle your project quickly and efficiently, whether you need a single conveyor or a complete powder handling system.

## Testing

Our fully equipped test facility, which is at your disposal, assesses performance of our machinery on your particular material. On-site trials can also be arranged if preferred.

## Manufacturing

We actively encourage customers to visit our modern manufacturing facility at any time. Here, we are able to process orders efficiently and to our high standards. We also have a similar manufacturing facility in the USA. Our systems and procedures have ISO9001:2000 accreditation.

## After sales

At Spiroflow, we firmly believe that after sales service forms an integral part of the product. Over 70% of our business comes from existing customers, whom we work with as partners from the moment of placing an order and throughout the equipment's operational life.

## Other equipment in the Spiroflow Range:

- Flexible Screw Conveyors
- Tubular Drag Conveyors
- Pneumatic and Vacuum Conveyors
- Bulk Bag Fillers
- Bulk Bag Dischargers
- Sack, Drum and IBC Emptiers
- Ingredients Handling Systems
- Batch and Continuous Weighing Systems
- Silo and Hopper Discharge Aids
- Continuous Mixing Systems



Flexible Screw Conveyors



Tubular Drag Conveyors



Vacuum Conveyors



Bulk Bag Fillers



Bulk Bag Dischargers

Contact us today to discuss your applications

**SPIROFLOW**  
CONVEYING & BULK BAG HANDLING SOLUTIONS



Certificate No. 6553

Spiroflow Limited  
Lincoln Way, Clitheroe,  
Lancashire, BB7 1QG, UK.

Telephone: +44 (0) 1200 422525  
Facsimile: +44 (0) 1200 429165  
Email: [sales@spiroflow.com](mailto:sales@spiroflow.com)  
Website: [www.spiroflow.com](http://www.spiroflow.com)

Spiroflow Systems Inc.  
2806 Gray Fox Road, Monroe,  
NC 28110, USA.

Telephone: (1) 704 291 9595  
Facsimile: (1) 704 291 9594  
Email: [info@spiroflowsystems.com](mailto:info@spiroflowsystems.com)  
Website: [www.spiroflowsystems.com](http://www.spiroflowsystems.com)



Designed and produced by CDM  
09/2010 Edition