

# 316 STAINLESS STEEL PRECISION PIPE FITTINGS



**Waverley brownall**

## THE COMPANY



Waverley brownall has progressed to become a leading supplier of pipeline components, valves and instrumentation products; providing solutions for the most demanding applications.

Our philosophy is dominated by quality. Each Waverley brownall product is designed using state-of-the-art CAD technology and is subjected to rigorous quality control procedures.

Waverley has built its reputation for quality instrumentation among the largest industrial companies. Our products are used on systems where corrosion resistance, high pressures, clean room environments and high temperatures are critical factors.

A range of over 2000 standard products, manufactured in the UK or sourced from approved suppliers are available ex-stock to assure you of immediate delivery whilst our engineers provide complete technical support and can assist in the design and development of custom-made solutions.

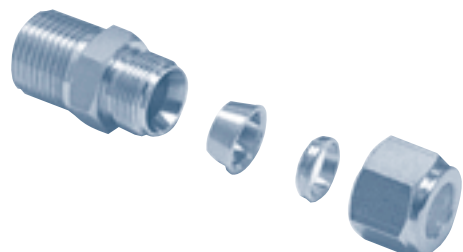
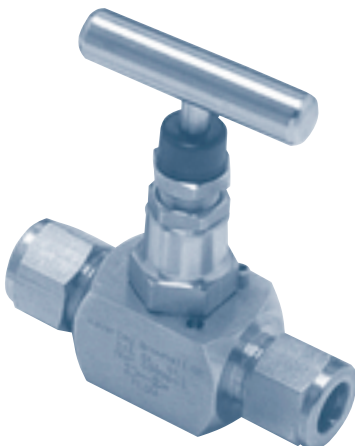
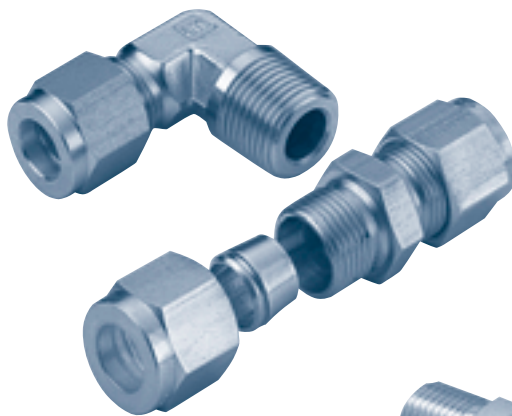
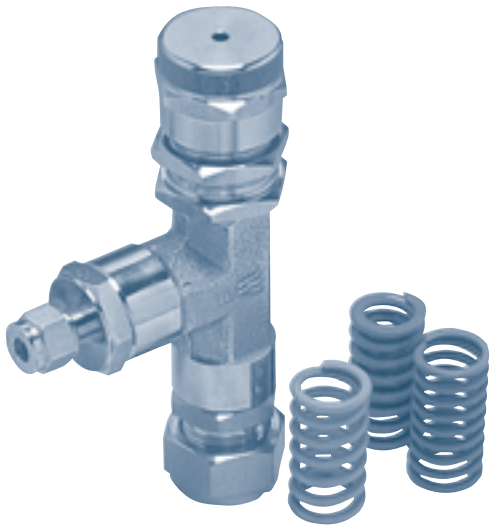

# APPROVALS

Our dedication to quality has led to us being awarded and maintaining BS EN ISO 9001 since 1986.

We also hold certificates of product conformance and approvals which include:

- LLOYDS** type approval to BS part 4
- LLOYDS** general approval for classified installations
- TUV** type approval
- AF KONTROLL** design approval
- BRITISH GAS** approved supplier
- BRITISH PETROLEUM** approved supplier
- BRITISH NUCLEAR FUELS** approved supplier
- SHELL** approved supplier
- TEXACO** approved supplier
- CEGB** approval
- POWERGEN** approved supplier
- EUROPEAN GAS TURBINES** approved supplier
- AMERICAN BUREAU OF SHIPPING** type approval



## UK Sales

Waverley brownall Ltd  
46, The Vintners, Temple Farm Industrial Estate  
Southend-on-Sea, Essex SS2 5RZ  
Tel: +44 (0)1702 600014  
Fax: +44 (0)1702 613600  
email: [sales@waverleybrownall.co.uk](mailto:sales@waverleybrownall.co.uk)  
[www.waverleybrownall.co.uk](http://www.waverleybrownall.co.uk)

Waverley brownall Scotland  
Tel: +44 (0)1224 877323

Featuring BSP screwed pipe fittings, 60° coned male unions, tube and hose components, plugs, bushes, caps, seals, NPT screwed pipe fittings, weld fittings and precision pipe fittings.

BSP screwed pipe fittings comply with BS 1740 or BS 1387. Reducing bushes up to 1" BSPT are stocked with taper internal threads. These are suitable for a safe working pressure of 3000psi and are used for adapting gauges, instruments and valves.

Hexagon nipples and hexagon reducing nipples up to 1" BSPT have bores to make them suitable for a safe working pressure of up to 6000psi.

60° coned male unions based on AGS 949 and BS 5200. Tube and hose adaptors based on BS 1906 and BS 2464. Any of the standpipe adaptors illustrated can be serrated to convert them to male or female hose adaptors. Standpipe adaptors are the same size as equivalent OD tube and therefore have a smaller OD than the equivalent hoesetail end.

BSPP plugs, bushes, and caps are manufactured from hexagons large enough to allow for the use of seals. Screw seal assemblies are stocked to suit all threads from 1/8" BSP - 2" BSP and suitable for a safe working pressure of 3000psi and are available in PTFE/stainless steel 316 and nitrile/stainless steel 316.

NPTF screwed pipe fittings are manufactured to comply with BS 3799. All catalogued items are stocked and suitable for use at a safe working pressure of up to 6000psi.

Weld fittings have been designed specifically for welded instrumentation systems. A necessary addition to this range is the compression to weld fitting for use on systems requiring the inline removal and replacement of certain critical components.

Waverley precision pipe fittings are manufactured from high quality 316 stainless steel forgings and each product in this range benefits from our cast coded system for easy traceability, even after many years in service. All threads available to NPT to ANSI/ASME B1.20.1.1983. BSPT to BS 21 and BSPP to BS 2779. Size range 1/8" to 1".

Waverley brownall also offer a full range of quality low pressure 316 stainless steel screwed fittings. These BSP fittings are available ex stock in sizes ranging from 1/8" to 2" and have a safe working pressure of 150 psi.

<b>HIGH PRESSURE PRECISION RANGE</b>	<b>page 4-10</b>
<b>PLUGS, BUSHES AND SEALS</b>	<b>page 11-13</b>
<b>HOSE COMPONENTS AND UNIONS</b>	<b>page 14-19</b>
<b>LOW PRESSURE CAST RANGE</b>	<b>page 20-26</b>
<b>WELD FITTINGS</b>	<b>page 27-31</b>



## HIGH PRESSURE PRECISION PIPE FITTINGS

**Hexagon Nipple**

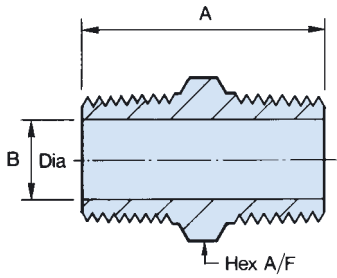

Thread BSPT	Part No	A Dim.	B Dia.	Hex A/F	WP psi
1/8"	N1	1.000"	0.156"	7/16"	6000
1/4"	N2	1.187"	0.218"	9/16"	6000
3/8"	N3	1.281"	0.343"	11/16"	6000
1/2"	N4	1.562"	0.437"	7/8"	6000
3/4"	N6	1.875"	0.625"	1 1/8"	6000
1"	N8	2.125"	0.875"	1 3/8"	5000
1 1/4"	N10	2.406"	1.125"	1 11/16"	3000
1 1/2"	N12	2.437"	1.375"	2.050"	3000
2"	N16	2.593"	1.812"	2 1/2"	3000

**Thread NPT**

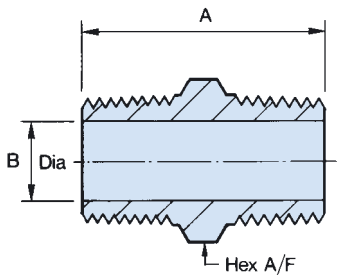

Thread NPT	Part No	A Dim.	B Dia.	Hex A/F	WP psi
1/8"	N1 NPT	1.000"	0.187"	7/16"	6000
1/4"	N2 NPT	1.187"	0.281"	9/16"	6000
3/8"	N3 NPT	1.281"	0.406"	11/16"	6000
1/2"	N4 NPT	1.562"	0.500"	7/8"	6000
3/4"	N6 NPT	1.875"	0.718"	1 1/8"	6000
1"	N8 NPT	2.125"	0.875"	1 3/8"	5000
1 1/4"	N10 NPT	2.406"	1.125"	1 11/16"	3000
1 1/2"	N12 NPT	2.437"	1.375"	2.050"	3000
2"	N16 NPT	2.593"	1.812"	2 1/2"	3000

**Hexagon Reducing Nipple**

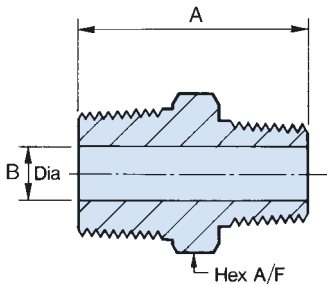

Thread BSPT	Part No	A Dim.	B Dia.	Hex A/F	WP psi
1/4" X 1/8"	RN2X1/8	1.093"	0.156"	9/16"	6000
3/8" X 1/8"	RN3X1/8	1.125"	0.156"	11/16"	6000
3/8" X 1/4"	RN3X1/4	1.218"	0.218"	11/16"	6000
1/2" X 1/4"	RN4X1/4	1.406"	0.218"	7/8"	6000
1/2" X 3/8"	RN4X3/8	1.437"	0.343"	7/8"	6000
3/4" X 1/4"	RN6X1/4	1.593"	0.218"	1 1/8"	5000
3/4" X 3/8"	RN6N3/8	1.625"	0.343"	1 1/8"	5000
3/4" X 1/2"	RN6X1/2	1.750"	0.437"	1 1/8"	3000
1" X 1/2"	RN8X1/2	1.875"	0.437"	1 3/8"	3000
1" X 3/4"	RN8X3/4	2.000"	0.625"	1 3/8"	3000

**Thread NPT**

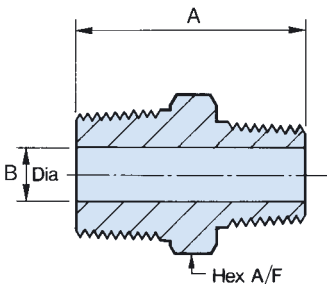

Thread NPT	Part No	A Dim.	B Dia.	Hex A/F	WP psi
1/4" X 1/8"	RN2X1/8 NPT	1.187"	0.187"	9/16"	6000
3/8" X 1/8"	RN3X1/8 NPT	1.218"	0.187"	11/16"	6000
3/8" X 1/4"	RN3X1/4 NPT	1.406"	0.281"	11/16"	6000
1/2" X 1/4"	RN4X1/4 NPT	1.593"	0.281"	7/8"	6000
1/2" X 3/8"	RN4X3/8 NPT	1.625"	0.406"	7/8"	6000
3/4" X 1/4"	RN6X1/4 NPT	1.687"	0.281"	1 1/8"	5000
3/4" X 3/8"	RN6N3/8 NPT	1.687"	0.406"	1 1/8"	5000
3/4" X 1/2"	RN6X1/2 NPT	1.875"	0.500"	1 1/8"	3000
1" X 1/2"	RN8X1/2 NPT	2.093"	0.500"	1 3/8"	3000
1" X 3/4"	RN8X3/4 NPT	2.093"	0.718"	1 3/8"	3000

## HIGH PRESSURE PRECISION PIPE FITTINGS

Hexagon Reducing Coupling NPT

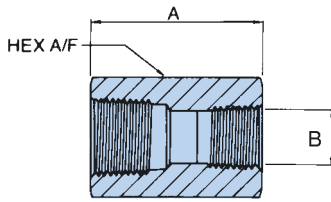

Thread NPT female/female	Part No	A Dim.	B Dia.	Hex A/F	WP psi
1/4" X 1/8"	HRC2X1/8NPT	1.125"	0.344"	3/4"	6000
3/8" X 1/4"	HRC3X1/4NPT	1.375"	0.422"	7/8"	5000
1/2" X 1/4"	HRC4X1/4NPT	1.750"	0.422"	1 1/6"	4500
1/2" X 3/8"	HRC4X3/8NPT	1.781"	0.562"	1 1/6"	4500
3/4" X 1/4"	HRC6X1/4NPT	1.812"	0.422"	1 5/15"	3300
3/4" X 3/8"	HRC6X3/8NPT	1.937"	0.562"	1 5/16"	3300
3/4" X 1/2"	HRC6X1/2NPT	2.062"	0.687"	1 5/16"	3300
1" X 1/2"	HRC8X1/2NPT	2.187"	0.687"	1 11/16"	4000
1" X 3/4"	HRC8X3/4NPT	2.250"	0.890"	1 11/16"	4000

High Pressure Reducing Bush NPT

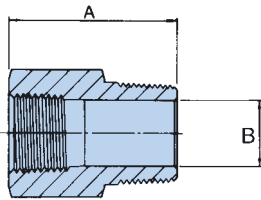

Thread NPT male/female	Part No	A Dim.	B Dia.	Hex A/F	WP psi
1/4" X 1/8"	HPRB2X1/8NPT	1.062"	0.281"	9/16"	6000
3/8" X 1/8"	HPRB3X1/8NPT	0.812"	0.328"	11/16"	6000
3/8" X 1/4"	HPRB3X1/4NPT	0.812"	0.437"	11/16"	6000
1/2" X 1/4"	HPRB4X1/4NPT	1.031"	0.437"	7/8"	6000
1/2" X 3/8"	HPRB4X3/8NPT	1.406"	0.500"	7/8"	6000
3/4" X 1/4"	HPRB6X1/4NPT	1.125"	0.437"	1 1/8"	6000
3/4" X 3/8"	HPRB6X3/8NPT	1.125"	0.562"	1 1/8"	6000
3/4" X 1/2"	HPRB6X1/2NPT	1.125"	0.703"	1 1/8"	4500
1" X 1/4"	HPRB8X1/4NPT	1.312"	0.437"	1 3/8"	5000
1" X 3/8"	HPRB8X3/8NPT	1.312"	0.562"	1 3/8"	5000
1" X 1/2"	HPRB8X1/2NPT	1.312"	0.703"	1 3/8"	4500
1" X 3/4"	HPRB8X3/4NPT	1.750"	0.875"	1 3/8"	3300

Reducing Bush NPT

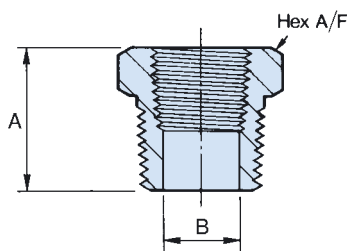

Thread NPT male/female	Part No	A Dim.	B Dia.	Hex A/F	WP psi
1/4" X 1/8"	RB2X1/8NPT	0.750"	0.197"	0.562"	3000
3/8" X 1/8"	RB3X1/8NPT	0.812"	0.197"	0.750"	3000
3/8" X 1/4"	RB3X1/4NPT	0.812"	0.250"	0.750"	3000
1/2" X 1/4"	RB4X1/4NPT	1.000"	0.250"	0.875"	3000
1/2" X 3/8"	RB4X3/8NPT	1.000"	0.375"	0.875"	3000
3/4" X 1/4"	RB6X1/4NPT	1.125"	0.250"	1.125"	3000
3/4" X 3/8"	RB6X3/8NPT	1.125"	0.375"	1.125"	3000
3/4" X 1/2"	RB6X1/2NPT	1.125"	0.500"	1.125"	3000
1" X 1/2"	RB8X1/2NPT	1.250"	0.500"	1.375"	3000
1" X 3/4"	RB8X3/4NPT	1.250"	0.687"	1.375"	3000
1 1/4" X 3/4"	RB10X3/4NPT	1.343"	0.687"	1.750"	3000
1 1/4" X 1"	RB10X1NPT	1.343"	0.875"	1.750"	3000
1 1/2" X 3/4"	RB12X3/4NPT	1.375"	0.687"	2.050"	3000
2" X 1/2"	RB16X1/2NPT	1.500"	0.500"	2.500"	3000
2" x 1"	RB16X1NPT	1.500"	0.875"	2.500"	3000

## HIGH PRESSURE PRECISION PIPE FITTINGS

**Reducing Bush BSPT**

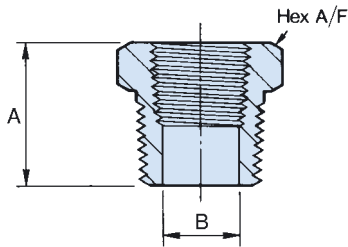

**Tapered Plug**

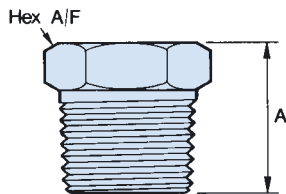
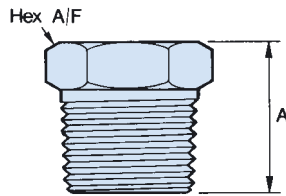

**Square Head Plug**

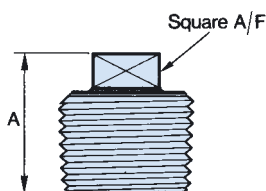

Thread BSPT male/female	Part No	A Dim.	B Dia.	Hex A/F	WP psi
1/4" X 1/8"	RB2X1/8T	0.750"	0.197"	0.562"	3000
3/8" X 1/4"	RB3X1/4T	0.812"	0.250"	0.750"	3000
1/2" X 1/4"	RB4X1/4T	1.000"	0.250"	0.875"	3000
1/2" X 3/8"	RB4X3/8T	1.000"	0.375"	0.875"	3000
3/4" X 1/4"	RB6X1/4T	1.125"	0.250"	1.125"	3000
3/4" X 3/8"	RB6X3/8T	1.125"	0.375"	1.125"	3000
3/4" X 1/2"	RB6X1/2T	1.125"	0.500"	1.125"	3000
1" X 1/4"	RB8X1/4T	1.250"	0.250"	1.375"	3000
1" X 3/8"	RB8X3/8T	1.250"	0.375"	1.375"	3000
1" X 1/2"	RB8X1/2T	1.250"	0.500"	1.375"	3000
1" X 3/4"	RB8X3/4T	1.250"	0.687"	1.375"	3000

PLEASE SEE THE LOW PRESSURE SECTION FOR LARGER SIZES

Thread BSPT	Part No	A Dim.	Hex A/F	WP (psi)
1/8"	TP1	0.562"	7/16"	6000
1/4"	TP2	0.718"	9/16"	6000
3/8"	TP3	0.781"	11/16"	6000
1/2"	TP4	0.937"	7/8"	6000
3/4"	TP6	1.125"	1 1/8"	6000
1"	TP8	1.250"	1 3/8"	5000
1 1/4"	TP10	1.406"	1 11/16"	3000
1 1/2"	TP12	1.437"	2.050"	3000
2"	TP16	1.531"	2 1/2"	3000

Thread NPT	Part No	A Dim.	Hex A/F	WP (psi)
1/8"	TP1 NPT	0.625"	7/16"	6000
1/4"	TP2 NPT	0.812"	9/16"	6000
3/8"	TP3 NPT	0.843"	11/16"	6000
1/2"	TP4 NPT	1.062"	7/8"	6000
3/4"	TP6 NPT	1.125"	1 1/8"	6000
1"	TP8 NPT	1.312"	1 3/8"	5000
1 1/4"	TP10 NPT	1.375"	1 11/16"	3000
1 1/2"	TP12 NPT	1.437"	2.050"	3000
2"	TP16 NPT	1.531"	2 1/2"	3000

Thread BSPT	Part No	A Dim.	Sq. A/F	WP (psi)
1/8"	SH1	0.611"	0.236"	6000
1/4"	SH2	0.750"	0.375"	6000
3/8"	SH3	0.875"	0.437"	6000
1/2"	SH4	0.937"	0.562"	6000
3/4"	SH6	1.125"	0.625"	6000
1"	SH8	1.200"	0.687"	5000



## HIGH PRESSURE PRECISION PIPE FITTINGS

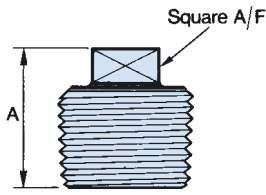

Thread NPT	Part No	A Dim.	Sq. A/F	WP (psi)
1/8"	SH1 NPT	0.630"	0.275"	6000
1/4"	SH2 NPT	0.669"	0.394"	6000
3/8"	SH3 NPT	0.827"	0.437"	6000
1/2"	SH4 NPT	0.945"	0.551"	6000
3/4"	SH6 NPT	1.062"	0.630"	6000
1"	SH8 NPT	1.260"	0.825"	5000

Socket Head Plug

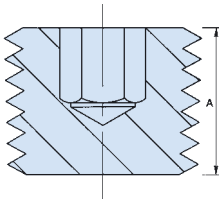

Thread BSPT	Part No	A Dim.	WP (psi)
1/8"	SHP1T	0.276"	6000
1/4"	SHP2T	0.433"	6000
3/8"	SHP3T	0.449"	6000
1/2"	SHP4T	0.591"	6000

Thread NPT	Part No	A Dim.	WP (psi)
1/8"	SHP1N	0.276"	6000
1/4"	SHP2N	0.433"	6000
3/8"	SHP3N	0.449"	6000
1/2"	SHP4N	0.591"	6000

Vent Plug

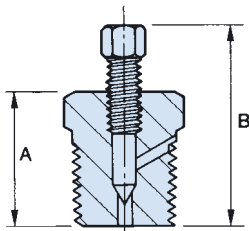

Thread BSPT	Part No	A Dim.	B Dim.	WP (psi)
1/4"	VP2	0.812"	1.210"	6000
1/2"	VP4	1.250"	1.703"	6000

Thread NPT	Part No	A Dim.	B Dim.	WP (psi)
1/4"	VP2 NPT	0.812"	1.210"	6000

Straight Adaptor

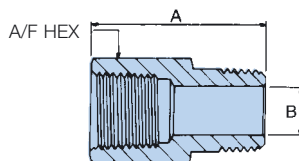

Thread NPT	Part No	A Dim.	B Dia.	Hex A/F	WP psi
1/8"	SA1	0.937"	0.156"	9/16"	6000
1/4"	SA2	1.187"	0.218"	3/4"	6000
3/8"	SA3	1.343"	0.343"	7/8"	6000
1/2"	SA4	1.656"	0.437"	1 1/8"	4500
3/4"	SA6	1.906"	0.625"	1 5/16"	3300
1"	SA8	2.156"	0.875"	1 11/16"	4000

## HIGH PRESSURE PRECISION PIPE FITTINGS

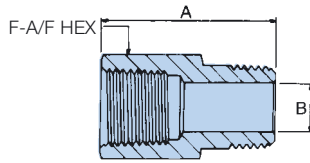

Thread NPT	Part No	A Dim.	B Dia.	Hex A/F	WP psi
1/8"	SA1 NPT	0.890"	0.187"	9/16"	6000
1/4"	SA2 NPT	1.218"	0.281"	3/4"	6000
3/8"	SA3 NPT	1.343"	0.406"	7/8"	6000
1/2"	SA4 NPT	1.718"	0.500"	1 1/8"	4500
3/4"	SA6 NPT	1.750"	0.718"	1 5/16"	3300
1"	SA8 NPT	2.125"	0.875"	1 11/16"	4000

### Reducing Adaptor

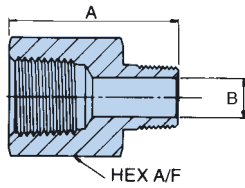

Thread BSPT	Part No	A Dim.	B Dia.	Hex A/F	WP psi
1/4" X 1/8"	RA2/1	1.250"	0.156"	3/4"	6000
3/8" X 1/4"	RA3/2	1.468"	0.218"	7/8"	6000
1/2" X 3/8"	RA4/3	1.750"	0.343"	1 1/8"	6000
3/4" X 1/2"	RA6/4	2.093"	0.437"	1 5/16"	3300
1" X 3/4"	RA8/6	2.281"	0.625"	1 11/16"	4000

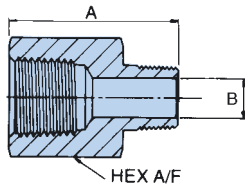

Thread NPT	Part No	A Dim.	B Dia.	Hex A/F	WP psi
1/4" X 1/8"	RA2/1 NPT	1.250"	0.156"	3/4"	6000
3/8" X 1/4"	RA3/2 NPT	1.500"	0.281"	7/8"	6000
1/2" X 3/8"	RA4/3 NPT	1.750"	0.406"	1 1/8"	6000
3/4" X 1/2"	RA6/4 NPT	2.062"	0.500"	1 5/16"	3300
1" X 3/4"	RA8/6 NPT	2.187"	0.718"	1 11/16"	4000

### Hexagon Pipe Cap

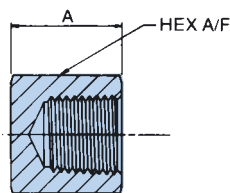

Thread NPT	Part No	A Dim.	Hex A/F	WP (psi)
1/8"	HPC1 NPT	0.593"	9/16"	6000
1/4"	HPC2 NPT	0.812"	3/4"	6000
3/8"	HPC3 NPT	0.875"	7/8"	6000
1/2"	HPC4 NPT	1.250"	1 1/8"	4500
3/4"	HPC6 NPT	1.328"	1 5/16"	3300
1"	HPC8 NPT	1.593"	1 11/16"	4000

# HIGH PRESSURE PRECISION PIPE FITTINGS

**Full Coupling**

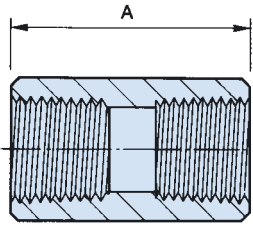

Thread NPT	Part No	A Dim.	Hex A/F	WP (psi)
1/8"	FC1 NPT	1.250"	9/16"	6000
1/4"	FC2 NPT	1.375"	3/4"	6000
3/8"	FC3 NPT	1.500"	7/8"	6000
1/2"	FC4 NPT	1.875"	1 1/8"	4500
3/4"	FC6 NPT	2.000"	1 5/16"	3300
1"	FC8 NPT	2.375"	1 11/16"	4000

**Half Coupling**

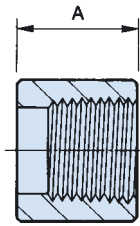

Thread NPT	Part No	A Dim.	Hex A/F	WP (psi)
1/8"	HCP1 NPT	0.625"	9/16"	6000
1/4"	HCP2 NPT	0.687"	3/4"	6000
3/8"	HCP3 NPT	0.750"	7/8"	6000
1/2"	HCP4 NPT	0.937"	1 1/8"	4500
3/4"	HCP6 NPT	1.000"	1 5/16"	3300
1"	HCP8 NPT	1.187"	1 11/16"	4000

**High Pressure Female Elbow**

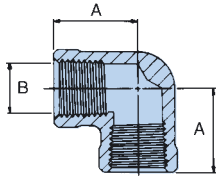

Thread BSPT	Part No	A Dim.	B Dia.	Hex A/F	WP psi
1/8"	HPE1	0.750"	0.328"	1/2"	6000
1/4"	HPE2	0.875"	0.437"	5/8"	6000
3/8"	HPE3	0.875"	0.562"	13/16"	6000
1/2"	HPE4	1.125"	0.703"	1 1/16"	5000
3/4"	HPE6	1.250"	0.906"	1 3/8"	5000

Thread NPT	Part No	A Dim.	B Dia.	Hex A/F	WP psi
1/8"	HPE1 NPT	0.750"	0.328"	1/2"	6000
1/4"	HPE2 NPT	0.875"	0.437"	5/8"	6000
3/8"	HPE3 NPT	0.875"	0.562"	13/16"	6000
1/2"	HPE4 NPT	1.125"	0.703"	1 1/16"	5000
3/4"	HPE6 NPT	1.250"	0.906"	1 3/8"	5000

**Male Elbow**

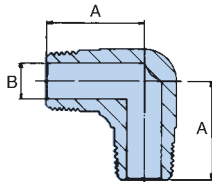

Thread BSPT	Part No	A Dim.	B Dia.	Hex A/F	WP psi
1/8"	ME1	0.687"	0.156"	3/8"	6000
1/4"	ME2	0.906"	0.218"	5/8"	6000
3/8"	ME3	1.000"	0.343"	13/16"	6000
1/2"	ME4	1.312"	0.437"	1 1/16"	5000
3/4"	ME6	1.437"	0.625"	1 1/16"	5000

Thread NPT	Part No	A Dim.	B Dia.	Hex A/F	WP psi
1/8"	ME1 NPT	0.687"	0.187"	3/8"	6000
1/4"	ME2 NPT	1.000"	0.281"	5/8"	6000
3/8"	ME3 NPT	1.062"	0.406"	13/16"	6000
1/2"	ME4 NPT	1.437"	0.500"	1 1/16"	5000
3/4"	ME6 NPT	1.437"	0.718"	1 1/16"	5000

## HIGH PRESSURE PRECISION PIPE FITTINGS

High Pressure Female Tee

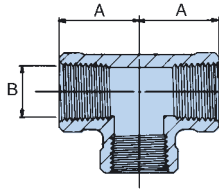

Thread	Part No	A Dim.	B Dia.	Hex A/F	WP psi
BSPT					
1/8"	HPT1	0.750"	0.328"	1/2"	6000
1/4"	HPT2	0.875"	0.437"	5/8"	6000
3/8"	HPT3	0.875"	0.562"	13/16"	6000
1/2"	HPT4	1.125"	0.703"	1 1/16"	5000
3/4"	HPT6	1.250"	0.906"	1 3/8"	5000

Thread Part No

Thread	Part No	A Dim.	B Dia.	Hex A/F	WP psi
NPT					
1/8"	HPT1 NPT	0.750"	0.328"	1/2"	6000
1/4"	HPT2 NPT	0.875"	0.437"	5/8"	6000
3/8"	HPT3 NPT	0.875"	0.562"	13/16"	6000
1/2"	HPT4 NPT	1.125"	0.703"	1 1/16"	5000
3/4"	HPT6 NPT	1.250"	0.906"	1 3/8"	5000

Male Tee

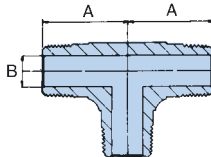

Thread Part No

Thread	Part No	A Dim.	B Dia.	Hex A/F	WP psi
BSPT					
1/8"	MT1	0.687"	0.156"	3/8"	6000
1/4"	MT2	0.906"	0.218"	5/8"	6000
3/8"	MT3	1.000"	0.343"	13/16"	6000
1/2"	MT4	1.312"	0.437"	1 1/16"	5000
3/4"	MT6	1.437"	0.625"	1 1/16"	5000

Thread Part No

Thread	Part No	A Dim.	B Dia.	Hex A/F	WP psi
NPT					
1/8"	MT1 NPT	0.687"	0.156"	3/8"	6000
1/4"	MT2 NPT	0.906"	0.218"	5/8"	6000
3/8"	MT3 NPT	1.000"	0.343"	13/16"	6000
1/2"	MT4 NPT	1.312"	0.437"	1 1/16"	5000
3/4"	MT6 NPT	1.437"	0.625"	1 1/16"	5000

## BSP parallel reducing socket 150lb class

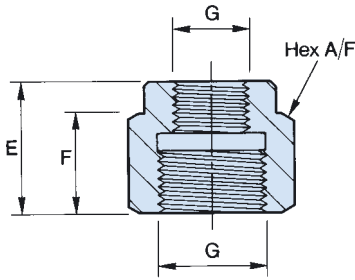

thread size G	part number	E	F	hex A/F	
1/4" BSP	1/8" BSP	<b>RS2</b>	0.900"	0.700"	0.750"
3/8" BSP	1/4" BSP	<b>RS3</b>	0.980"	0.780"	0.875"
1/2" BSP	1/4" BSP	<b>RS4/2</b>	1.050"	0.850"	1.125"
1/2" BSP	3/8" BSP	<b>RS4</b>	1.130"	0.850"	1.125"
3/4" BSP	1/2" BSP	<b>RS6</b>	1.350"	1.000"	1.300"
1" BSP	1/2" BSP	<b>RS8/4</b>	1.400"	1.000"	1.670"
1" BSP	3/4" BSP	<b>RS8</b>	1.550"	1.050"	1.670"
1 1/4" BSP	1" BSP	<b>RS10</b>	1.600"	1.050"	2.050"
1 1/2" BSP	1 1/4" BSP	<b>RS12</b>	1.700"	1.150"	2.220"
2" BSP	1 1/2" BSP	<b>RS16</b>	1.900"	1.250"	2.750"

## BSP parallel welding boss 150lb class

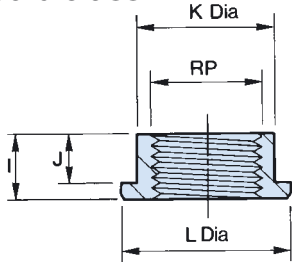

thread size G	part number	I	J	K Dia	L Dia
1/8" BSP	<b>B1</b>	0.312"	0.325"	0.532"	0.625"
1/4" BSP	<b>B2</b>	0.450"	0.325"	0.750"	0.875"
3/8" BSP	<b>B3</b>	0.530"	0.405"	0.875"	1.062"
1/2" BSP	<b>B4</b>	0.600"	0.475"	1.000"	1.125"
3/4" BSP	<b>B6</b>	0.625"	0.562"	1.250"	1.500"
1" BSP	<b>B8</b>	0.800"	0.550"	1.750"	2.000"

## BSP parallel - NPTF screwed bush 150lb class

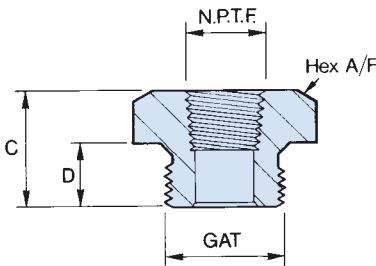

thread size external GAT	internal NPTF	part number	C	D	hex A/F
1/4" BSP	1/8" NPTF	<b>SB2/1N</b>	0.700"	0.450"	0.750"
3/8" BSP	1/8" NPTF	<b>SB3/1N</b>	0.780"	0.530"	0.875"
3/8" BSP	1/4" NPTF	<b>SB3/2N</b>	0.780"	0.530"	0.875"
1/2" BSP	1/8" NPTF	<b>SB4/1N</b>	1.000"	0.625"	1.125"
1/2" BSP	1/4" NPTF	<b>SB4/2N</b>	1.000"	0.625"	1.125"
1/2" BSP	3/8" NPTF	<b>SB4/3N</b>	1.000"	0.625"	1.125"
3/4" BSP	1/4" NPTF	<b>SB6/2N</b>	1.125"	0.750"	1.300"
3/4" BSP	3/8" NPTF	<b>SB6/3N</b>	1.125"	0.750"	1.300"
3/4" BSP	1/2" NPTF	<b>SB6/4N</b>	1.125"	0.750"	1.300"
1" BSP	1/4" NPTF	<b>SB8/2N</b>	1.175"	0.800"	1.670"
1" BSP	3/8" NPTF	<b>SB8/3N</b>	1.175"	0.800"	1.670"
1" BSP	1/2" NPTF	<b>SB8/4N</b>	1.175"	0.800"	1.670"
1" BSP	3/4" NPTF	<b>SB8/6N</b>	1.175"	0.800"	1.670"

## BSP parallel screwed bush 150lb class

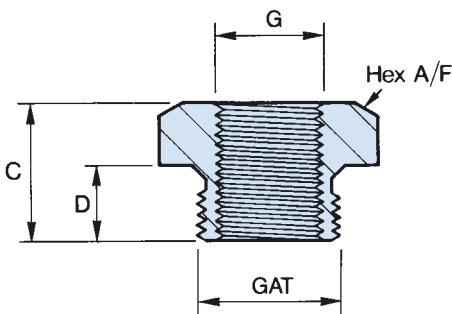

thread size external GAT	internal G	part number	C	D	hex A/F
1/4" BSP	1/8" BSP	<b>SB2</b>	0.700"	0.450"	0.750"
3/8" BSP	1/8" BSP	<b>SB3/1</b>	0.780"	0.530"	0.875"
3/8" BSP	1/4" BSP	<b>SB3</b>	0.780"	0.530"	0.875"
1/2" BSP	1/8" BSP	<b>SB4/1</b>	1.000"	0.625"	1.125"
1/2" BSP	1/4" BSP	<b>SB4/2</b>	1.000"	0.625"	1.125"
1/2" BSP	3/8" BSP	<b>SB4</b>	1.000"	0.625"	1.125"
3/4" BSP	1/8" BSP	<b>SB6/1</b>	1.125"	0.750"	1.300"
3/4" BSP	1/4" BSP	<b>SB6/2</b>	1.125"	0.750"	1.300"
3/4" BSP	3/8" BSP	<b>SB6/3</b>	1.125"	0.750"	1.300"
3/4" BSP	1/2" BSP	<b>SB6</b>	1.125"	0.750"	1.300"
1" BSP	1/4" BSP	<b>SB8/2</b>	1.175"	0.800"	1.670"
1" BSP	3/8" BSP	<b>SB8/3</b>	1.175"	0.800"	1.670"
1" BSP	1/2" BSP	<b>SB8/4</b>	1.175"	0.800"	1.670"
1" BSP	3/4" BSP	<b>SB8</b>	1.175"	0.800"	1.670"
1 1/4" BSP	3/4" BSP	<b>SB10/6</b>	1.237"	0.800"	2.050"
1 1/4" BSP	1" BSP	<b>SB10</b>	1.237"	0.800"	2.050"
1 1/2" BSP	1" BSP	<b>SB12/8</b>	1.287"	0.900"	2.220"
1 1/2" BSP	1 1/4" BSP	<b>SB12</b>	1.287"	0.900"	2.220"
2" BSP	1" BSP	<b>SB16/8</b>	1.437"	1.000"	2.750"
2" BSP	1 1/2" BSP	<b>SB16</b>	1.437"	1.000"	2.750"

## BSP parallel hexagon plug 3000lb class

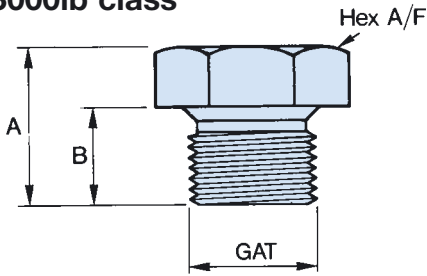

thread size GAT	part number	A	B	hex A/F
1/8" BSP	<b>P1</b>	0.570"	0.350"	0.562"
1/4" BSP	<b>P2</b>	0.700"	0.450"	0.750"
3/8" BSP	<b>P3</b>	0.780"	0.530"	0.875"
1/2" BSP	<b>P4</b>	1.000"	0.625"	1.125"
3/4" BSP	<b>P6</b>	1.125"	0.750"	1.300"
1" BSP	<b>P8</b>	1.175"	0.800"	1.670"
1 1/4" BSP	<b>P10</b>	1.237"	0.800"	2.050"
1 1/2" BSP	<b>P12</b>	1.287"	0.900"	2.220"
2" BSP	<b>P16</b>	1.437"	1.000"	2.750"

BSP Parallel Plugs can be drilled and tapped to convert into Screwed Bushes to order

## BSP parallel plug coned 3000lb class

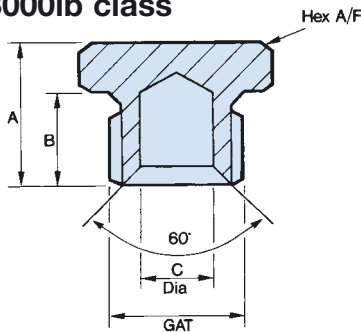

thread size GAT	part number	A	B	C dia	hex A/F
1/8" BSP	<b>P1 coned</b>	0.570"	0.350"	0.125"	0.562"
1/4" BSP	<b>P2 coned</b>	0.700"	0.450"	0.250"	0.750"
3/8" BSP	<b>P3 coned</b>	0.780"	0.530"	0.375"	0.875"
1/2" BSP	<b>P4 coned</b>	1.000"	0.625"	0.500"	1.125"

## BSP parallel hexagon cap 3000lb class

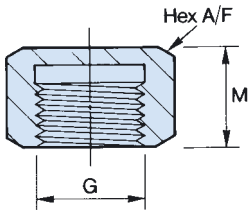

thread size G	part number	M	Hex A/F
1/8" BSP	<b>HC1</b>	0.500"	0.562"
1/4" BSP	<b>HC2</b>	0.500"	0.750"
3/8" BSP	<b>HC3</b>	0.593"	0.875"
1/2" BSP	<b>HC4</b>	0.750"	1.125"
3/4" BSP	<b>HC6</b>	0.870"	1.300"
1" BSP	<b>HC8</b>	0.937"	1.670"
1 1/2" BSP	<b>HC12</b>	1.500"	2.220"

## BSP parallel screw seal assembly 3000lb class

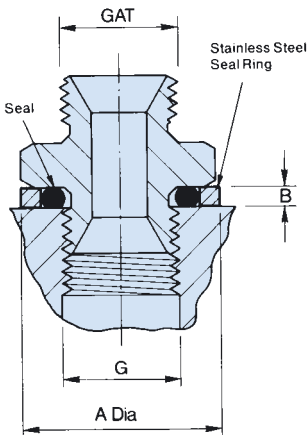

## Stainless seal ring with PTFE seal

thread size GAT/G	part number	A dia	B
1/8" BSP	<b>SR1PT</b>	0.625"	0.056"
1/4" BSP	<b>SR2PT</b>	0.875"	0.056"
3/8" BSP	<b>SR3PT</b>	1.000"	0.056"
1/2" BSP	<b>SR4PT</b>	1.250"	0.086"
3/4" BSP	<b>SR6PT</b>	1.500"	0.086"
1" BSP	<b>SR8PT</b>	1.750"	0.086"
1 1/4" BSP	<b>SR10PT</b>	2.375"	0.115"
1 1/2" BSP	<b>SR12PT</b>	2.525"	0.115"
2" BSP	<b>SR16PT</b>	3.125"	0.115"

## Stainless seal ring with nitrile seal

thread size GAT/G	part number	A dia	B
1/8" BSP	<b>SR1NT</b>	0.625"	0.056"
1/4" BSP	<b>SR2NT</b>	0.875"	0.056"
3/8" BSP	<b>SR3NT</b>	1.000"	0.056"
1/2" BSP	<b>SR4NT</b>	1.250"	0.086"
3/4" BSP	<b>SR6NT</b>	1.500"	0.086"
1" BSP	<b>SR8NT</b>	1.750"	0.086"
1 1/4" BSP	<b>SR10NT</b>	2.375"	0.115"
1 1/2" BSP	<b>SR12NT</b>	2.525"	0.115"
2" BSP	<b>SR16NT</b>	3.125"	0.115"

## Stainless seal rings only



thread size	part number
1/8" BSP	SR1
1/4" BSP	SR2
3/8" BSP	SR3
1/2" BSP	SR4
3/4" BSP	SR6
1" BSP	SR8
1 1/4" BSP	SR10
1 1/2" BSP	SR12
2" BSP	SR16

## PTFE seals only



thread size	part number
1/8" BSP	OR1PT
1/4" BSP	OR2PT
3/8" BSP	OR3PT
1/2" BSP	OR4PT
3/4" BSP	OR6PT
1" BSP	OR8PT
1 1/4" BSP	OR10PT
1 1/2" BSP	OR12PT
2" BSP	OR16PT

## Nitrile seals only

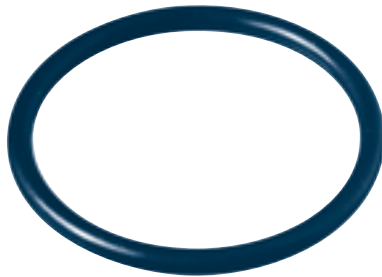

thread size	part number
1/8" BSP	OR1
1/4" BSP	OR2
3/8" BSP	OR3
1/2" BSP	OR4
3/4" BSP	OR6
1" BSP	OR8
1 1/4" BSP	OR10
1 1/2" BSP	OR12
2" BSP	OR16

**Square hose adaptors**  
page 5.10

**Hose adaptor 60° cone**  
page 5.09

**Union nut**  
page 5.09

**Female hose union assembly**

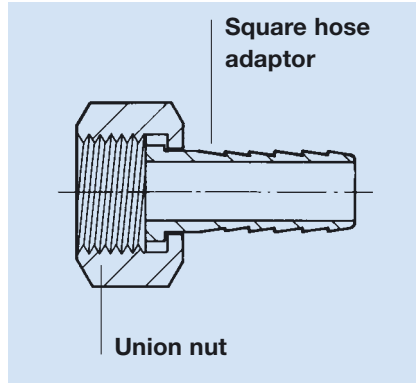

**Female hose union assembly 60° cone**

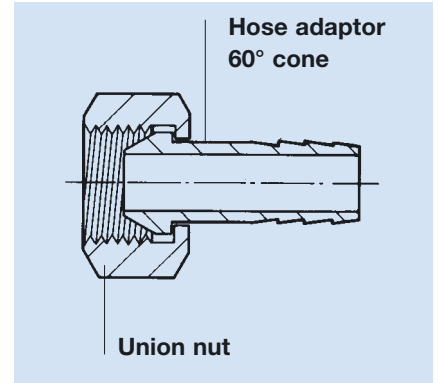

**Female hose union assembly finger tight**

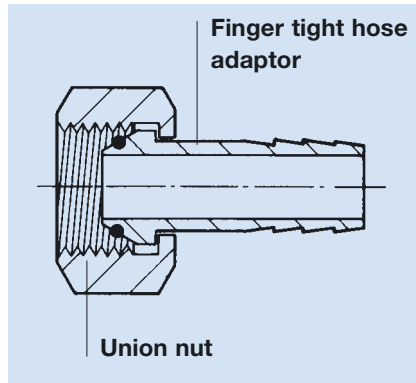

**Hose to hose connector**

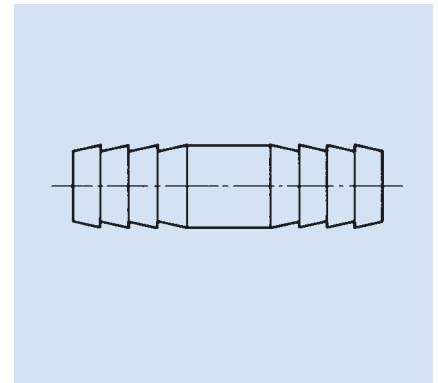

**Finger tight hose adaptor**  
page 5.10

**OD tube to hose coupling**

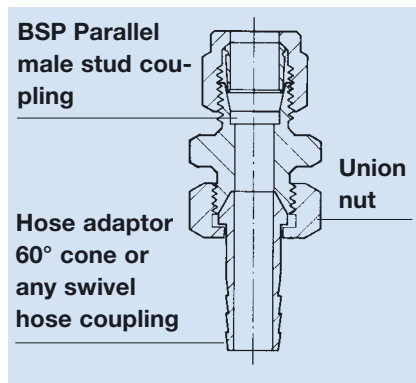

**Male tube union assembly**

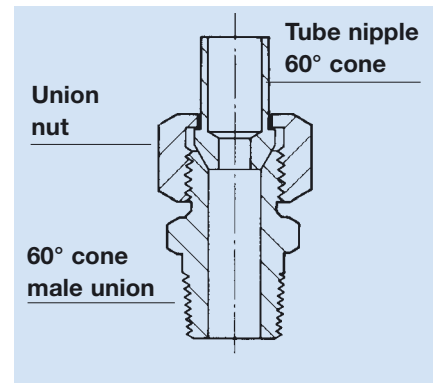

**BSP parallel male stud coupling single or double ferrule option**  
section 1

**Tube nipple 60° cone**  
page 5.09

**60° cone male union**  
page 5.07, 5.09

**Hose adaptor 60° cone**  
page 5.09



## BSP – BSPT male union 3000lb class

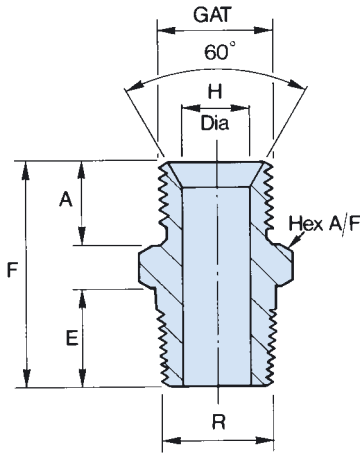

thread size GAT	thread size R	part number	A	E	F	H dia	hex A/F
1/8" BSP	1/8" BSPT	<b>U1/N1</b>	0.450"	0.375"	1.075"	0.125"	0.562"
1/4" BSP	1/8" BSPT	<b>U2/N1</b>	0.450"	0.375"	1.075"	0.197"	0.750"
1/4" BSP	1/4" BSPT	<b>U2/N2</b>	0.450"	0.500"	1.200"	0.250"	0.750"
1/4" BSP	3/8" BSPT	<b>U2/N3</b>	0.450"	0.562"	1.262"	0.250"	0.875"
1/4" BSP	1/2" BSPT	<b>U2/N4</b>	0.450"	0.687"	1.324"	0.250"	1.125"
3/8" BSP	1/8" BSPT	<b>U3/N1</b>	0.530"	0.375"	1.155"	0.197"	0.875"
3/8" BSP	1/4" BSPT	<b>U3/N2</b>	0.530"	0.500"	1.280"	0.250"	0.875"
3/8" BSP	3/8" BSPT	<b>U3/N3</b>	0.530"	0.562"	1.342"	0.375"	0.875"
3/8" BSP	1/2" BSPT	<b>U3/N4</b>	0.530"	0.687"	1.529"	0.375"	1.125"
1/2" BSP	1/4" BSPT	<b>U4/N2</b>	0.600"	0.500"	1.412"	0.250"	1.125"
1/2" BSP	3/8" BSPT	<b>U4/N3</b>	0.600"	0.562"	1.474"	0.375"	1.125"
1/2" BSP	1/2" BSPT	<b>U4/N4</b>	0.600"	0.687"	1.599"	0.500"	1.125"
1/2" BSP	3/4" BSPT	<b>U4/N6</b>	0.600"	0.750"	1.725"	0.500"	1.125"
1/2" BSP	1" BSPT	<b>U4/N8</b>	0.600"	0.875"	1.850"	0.500"	1.375"
3/4" BSP	1/2" BSPT	<b>U6/N4</b>	0.750"	0.687"	1.812"	0.500"	1.300"
3/4" BSP	3/4" BSPT	<b>U6/N6</b>	0.750"	0.750"	1.875"	0.687"	1.300"
3/4" BSP	1" BSPT	<b>U6/N8</b>	0.750"	0.875"	2.000"	0.687"	1.375"
1" BSP	1/2" BSPT	<b>U8/N4</b>	0.800"	0.687"	1.862"	0.500"	1.670"
1" BSP	3/4" BSPT	<b>U8/N6</b>	0.800"	0.750"	1.925"	0.687"	1.670"
1" BSP	1" BSPT	<b>U8/N8</b>	0.800"	0.875"	2.050"	0.875"	1.670"
1 1/4" BSP	1 1/4" BSPT	<b>U10/N10</b>	0.800"	0.906"	2.143"	1.125"	2.050"
1 1/2" BSP	1 1/2" BSPT	<b>U12/N12</b>	0.900"	0.937"	2.274"	1.375"	2.220"
2" BSP	2" BSPT	<b>U16/N16</b>	1.000"	1.062"	2.499"	1.750"	2.750"

## BSP – NPTF male union 3000lb class

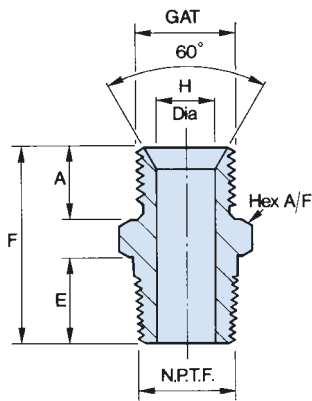

thread size GAT	thread size NPTF	part number	A	E	F	H dia	hex A/F
1/8" BSP	1/8" NPTF	<b>U1/N1N</b>	0.450"	0.375"	1.075"	0.125"	0.562"
1/4" BSP	1/8" NPTF	<b>U2/N1N</b>	0.450"	0.375"	1.075"	0.125"	0.562"
1/4" BSP	1/4" NPTF	<b>U2/N2N</b>	0.450"	0.500"	1.200"	0.250"	0.750"
1/4" BSP	3/8" NPTF	<b>U2/N3N</b>	0.450"	0.562"	1.262"	0.250"	0.750"
1/4" BSP	1/2" NPTF	<b>U2/N4N</b>	0.450"	0.687"	1.449"	0.250"	0.875"
3/8" BSP	1/8" NPTF	<b>U3/N1N</b>	0.530"	0.375"	1.155"	0.125"	0.875"
3/8" BSP	1/4" NPTF	<b>U3/N2N</b>	0.530"	0.500"	1.280"	0.250"	0.875"
3/8" BSP	3/8" NPTF	<b>U3/N3N</b>	0.530"	0.562"	1.342"	0.375"	0.875"
1/2" BSP	1/4" NPTF	<b>U4/N2N</b>	0.600"	0.500"	1.412"	0.250"	1.125"
1/2" BSP	3/8" NPTF	<b>U4/N3N</b>	0.600"	0.562"	1.474"	0.375"	1.125"
1/2" BSP	1/2" NPTF	<b>U4/N4N</b>	0.600"	0.687"	1.599"	0.500"	1.125"
1/2" BSP	3/4" NPTF	<b>U4/N6N</b>	0.600"	0.750"	1.725"	0.500"	1.300"
1/2" BSP	1" NPTF	<b>U4/N8N</b>	0.600"	0.875"	1.850"	0.500"	1.375"
3/4" BSP	1/2" NPTF	<b>U6/N4N</b>	0.750"	0.687"	1.812"	0.500"	1.300"
3/4" BSP	3/4" NPTF	<b>U6/N6N</b>	0.750"	0.750"	1.875"	0.687"	1.300"
1" BSP	1/2" NPTF	<b>U8/N4N</b>	0.800"	0.687"	1.862"	0.500"	1.670"
1" BSP	3/4" NPTF	<b>U8/N6N</b>	0.800"	0.750"	1.925"	0.687"	1.670"
1" BSP	1" NPTF	<b>U8/N8N</b>	0.800"	0.875"	2.050"	0.875"	1.670"
1 1/4" BSP	1 1/4" NPTF	<b>U10/N10N</b>	0.800"	0.906"	2.143"	1.125"	2.050"
1 1/2" BSP	1 1/2" NPTF	<b>U12/N12N</b>	0.900"	0.937"	2.274"	1.375"	2.220"
2" BSP	2" NPTF	<b>U16/N16N</b>	1.000"	1.062"	2.500"	1.500"	2.750"

## BSP – BSPP male union 3000lb class

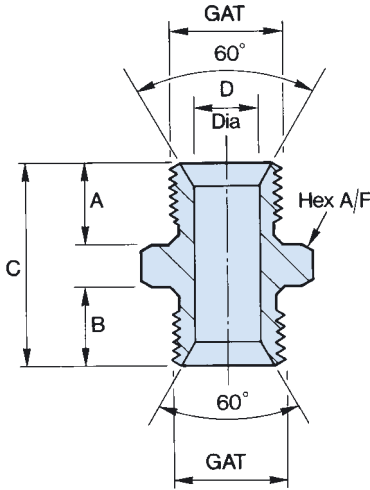

thread size GAT		part number	A	B	C	D dia	hex A/F
1/8" BSP	1/8" BSP	<b>U1</b>	0.450"	0.450"	1.150"	0.125"	0.562"
1/4" BSP	1/8" BSP	<b>U2R</b>	0.450"	0.450"	1.150"	0.125"	0.750"
1/4" BSP	1/4" BSP	<b>U2</b>	0.450"	0.450"	1.150"	0.250"	0.750"
3/8" BSP	1/8" BSP	<b>U3R/1</b>	0.530"	0.450"	1.230"	0.125"	0.875"
3/8" BSP	1/4" BSP	<b>U3R</b>	0.530"	0.450"	1.230"	0.250"	0.875"
3/8" BSP	3/8" BSP	<b>U3</b>	0.530"	0.530"	1.312"	0.375"	0.875"
1/2" BSP	1/4" BSP	<b>U4R/2</b>	0.600"	0.450"	1.362"	0.250"	1.125"
1/2" BSP	3/8" BSP	<b>U4R</b>	0.600"	0.530"	1.442"	0.375"	1.125"
1/2" BSP	1/2" BSP	<b>U4</b>	0.600"	0.600"	1.512"	0.500"	1.125"
5/8" BSP	5/8" BSP	<b>U5</b>	0.625"	0.625"	1.562"	0.531"	1.125"
3/4" BSP	3/8" BSP	<b>U6R/3</b>	0.750"	0.530"	1.655"	0.375"	1.300"
3/4" BSP	1/2" BSP	<b>U6R</b>	0.750"	0.600"	1.725"	0.500"	1.300"
3/4" BSP	5/8" BSP	<b>U6R/5</b>	0.750"	0.625"	1.750"	0.531"	1.300"
3/4" BSP	3/4" BSP	<b>U6</b>	0.750"	0.750"	1.875"	0.687"	1.300"
1" BSP	3/8" BSP	<b>U8R/3</b>	0.800"	0.530"	1.705"	0.375"	1.670"
1" BSP	1/2" BSP	<b>U8R/4</b>	0.800"	0.600"	1.775"	0.500"	1.670"
1" BSP	3/4" BSP	<b>U8R</b>	0.800"	0.750"	1.925"	0.687"	1.670"
1" BSP	1" BSP	<b>U8</b>	0.800"	0.800"	1.975"	0.875"	1.670"
1 1/4" BSP	1" BSP	<b>U10R</b>	0.800"	0.800"	2.037"	0.875"	2.050"
1 1/4" BSP	1 1/4" BSP	<b>U10</b>	0.800"	0.800"	2.037"	1.125"	2.050"
1 1/2" BSP	3/4" BSP	<b>U12R/6</b>	0.900"	0.750"	2.087"	0.687"	2.220"
1 1/2" BSP	1" BSP	<b>U12R/8</b>	0.900"	0.800"	2.137"	0.875"	2.220"
1 1/2" BSP	1 1/4" BSP	<b>U12R</b>	0.900"	0.800"	2.137"	1.125"	2.220"
1 1/2" BSP	1 1/2" BSP	<b>U12</b>	0.900"	0.900"	2.237"	1.375"	2.220"
2" BSP	1" BSP	<b>U16R/8</b>	1.000"	0.800"	2.237"	0.875"	2.750"
2" BSP	1 1/4" BSP	<b>U16R/10</b>	1.000"	0.800"	2.237"	1.125"	2.750"
2" BSP	1 1/2" BSP	<b>U16R</b>	1.000"	0.900"	2.337"	1.375"	2.750"
2" BSP	2" BSP	<b>U16</b>	1.000"	1.000"	2.437"	1.750"	2.750"

## BSPP – bulkhead union 3000lb class with hexagon back nut

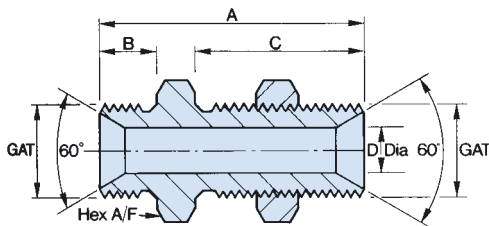

thread size GAT	part number	A	B	C	D dia	hex A/F	bulkhead bore dia
1/4"	<b>BU2</b>	2.125"	0.450"	1.400"	0.250"	0.750"	0.520"
3/8"	<b>BU3</b>	2.192"	0.550"	1.410"	0.375"	0.875"	0.656"
1/2"	<b>BU4</b>	2.350"	0.600"	1.500"	0.510"	1.125"	0.828"
3/4"	<b>BU6</b>	2.875"	0.750"	1.750"	0.760"	1.300"	1.032"
1"	<b>BU8</b>	2.975"	0.800"	1.800"	0.875"	1.670"	1.312"
1 1/2"	<b>BU12</b>	3.310"	0.900"	1.900"	1.310"	2.220"	1.990"

## BSPP – union nut 3000lb class

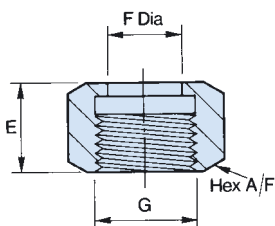

thread size G	part number	E	F dia	hex A/F
1/8" BSP	<b>UN1</b>	0.500"	0.250"	0.562"
1/4" BSP	<b>UN2</b>	0.500"	0.365"	0.750"
3/8" BSP	<b>UN3</b>	0.593"	0.490"	0.875"
1/2" BSP	<b>UN4</b>	0.750"	0.610"	1.125"
3/4" BSP	<b>UN6</b>	0.750"	0.870"	1.300"
1" BSP	<b>UN8</b>	0.937"	1.100"	1.670"
1 1/4" BSP	<b>UN10</b>	1.000"	1.390"	2.050"
1 1/2" BSP	<b>UN12</b>	1.125"	1.650"	2.220"
2" BSP	<b>UN16</b>	1.375"	2.125"	2.750"

## BSPT male hose adaptor

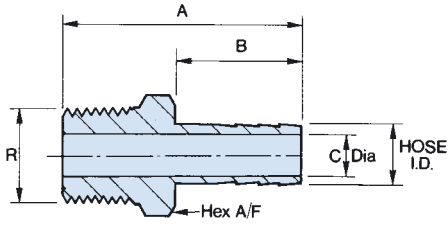

thread size R	hose ID	part number	A	B	C dia	hex A/F
1/8" BSPT	1/4"	<b>MH2/1T</b>	1.625"	1.000"	0.188"	0.437"
1/4" BSPT	1/4"	<b>MH2T</b>	1.750"	1.000"	0.188"	0.562"
1/4" BSPT	3/8"	<b>MH3/2T</b>	1.812"	1.062"	0.188"	0.562"
3/8" BSPT	3/8"	<b>MH3T</b>	1.875"	1.062"	0.312"	0.750"
1/4" BSPT	1/2"	<b>MH4/2T</b>	1.875"	1.125"	0.188"	0.562"
3/8" BSPT	1/2"	<b>MH4/3T</b>	1.937"	1.125"	0.312"	0.750"
1/2" BSPT	1/2"	<b>MH4T</b>	2.125"	1.125"	0.406"	0.875"
1/2" BSPT	3/4"	<b>MH6/4T</b>	2.499"	1.500"	0.406"	0.875"
3/4" BSPT	3/4"	<b>MH6T</b>	2.625"	1.500"	0.640"	1.125"
1/2" BSPT	1"	<b>MH8/4T</b>	2.561"	1.562"	0.406"	1.125"
1" BSPT	1"	<b>MH8T</b>	2.812"	1.562"	0.800"	1.375"
1 1/4" BSPT	1 1/4"	<b>MH10T</b>	3.093"	1.750"	1.050"	1.750"
1 1/2" BSPT	1 1/2"	<b>MH12T</b>	3.374"	2.000"	1.281"	2.050"
2" BSPT	2"	<b>MH16T</b>	3.749"	2.250"	1.750"	2.500"

## NPTF male hose adaptor

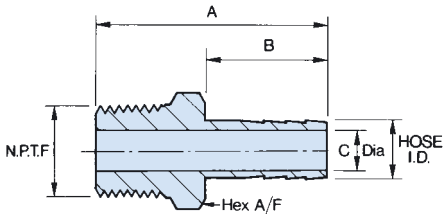

thread size NPTF	hose ID	part number	A	B	C dia	hex A/F
1/8" NPTF	1/4"	<b>MH2/1N</b>	1.625"	1.000"	0.188"	0.437"
1/4" NPTF	1/4"	<b>MH2N</b>	1.750"	1.000"	0.188"	0.562"
1/4" NPTF	3/8"	<b>MH3/2N</b>	1.812"	1.062"	0.188"	0.562"
3/8" NPTF	3/8"	<b>MH3N</b>	1.875"	1.062"	0.312"	0.750"
1/4" NPTF	1/2"	<b>MH4/2N</b>	1.875"	1.125"	0.188"	0.562"
3/8" NPTF	1/2"	<b>MH4/3N</b>	1.937"	1.125"	0.312"	0.750"
1/2" NPTF	1/2"	<b>MH4N</b>	2.125"	1.125"	0.406"	0.875"
3/4" NPTF	3/4"	<b>MH6N</b>	2.625"	1.500"	0.640"	1.125"
1" NPTF	1"	<b>MH8N</b>	2.812"	1.562"	0.800"	1.375"
1 1/4" NPTF	1 1/4"	<b>MH10N</b>	3.093"	1.750"	1.050"	1.750"
1 1/2" NPTF	1 1/2"	<b>MH12N</b>	3.374"	2.000"	1.281"	2.050"
2" NPTF	2"	<b>MH16N</b>	3.749"	2.250"	1.750"	2.500"

## BSPP female hose adaptor

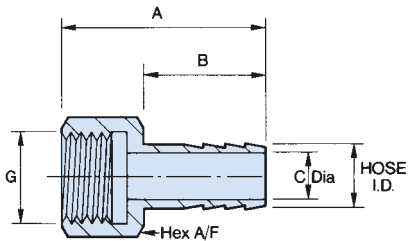

thread size G	hose ID	part number	A	B	C dia	hex A/F
1/4" BSP	1/4"	<b>FH2</b>	1.687"	1.000"	0.188"	0.750"
3/8" BSP	3/8"	<b>FH3</b>	1.750"	1.000"	0.312"	0.875"
1/2" BSP	1/2"	<b>FH4</b>	2.000"	1.125"	0.406"	1.125"

## Finger tight hose adaptor

Supplied with nitrile or PTFE O-ring seal  
For use with BSP union nut on previous page

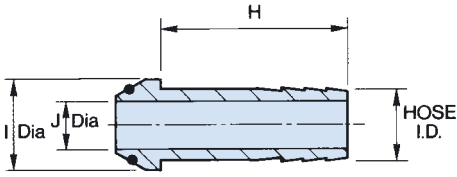

hose ID	part number	H	I dia	J dia
1/4"	<b>FHA2</b>	1.000"	0.437"	0.188"
3/8"	<b>FHA3</b>	1.125"	0.576"	0.312"
1/2"	<b>FHA4</b>	1.312"	0.730"	0.406"
3/4"	<b>FHA6</b>	1.500"	0.950"	0.640"
1"	<b>FHA8</b>	1.562"	1.188"	0.875"

## Square hose adaptor

For use with BSP union nut on previous page

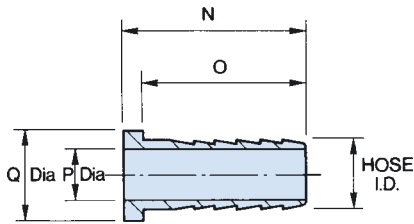

hose ID	part number	N	O	P dia	Q dia
1/4"	<b>SHA2</b>	1.100"	1.000"	0.188"	0.437"
3/8"	<b>SHA3</b>	1.225"	1.125"	0.312"	0.576"
1/2"	<b>SHA4</b>	2.000"	1.812"	0.406"	0.730"
3/4"	<b>SHA6</b>	2.000"	1.812"	0.640"	0.950"
1"	<b>SHA8</b>	2.000"	1.812"	0.800"	1.188"
1 1/4"	<b>SHA10</b>	1.900"	1.750"	1.000"	1.500"
1 1/2"	<b>SHA12</b>	2.275"	2.125"	1.281"	1.750"
2"	<b>SHA16</b>	2.475"	2.250"	1.750"	2.200"

## Tube nipple 60° cone

For use with union nut on previous page  
To be used for brazing or welding, supplied with O-ring to order

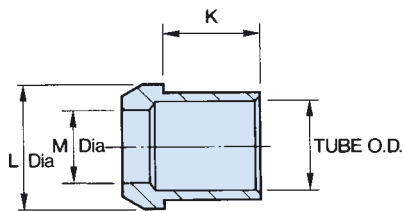

tube OD	part number	K	L dia	M dia
1/8"	<b>TN1</b>	0.250"	0.330"	0.093"
1/4"	<b>TN2</b>	0.320"	0.437"	0.180"
3/8"	<b>TN3</b>	0.400"	0.570"	0.300"
1/2"	<b>TN4</b>	0.550"	0.730"	0.420"
3/4"	<b>TN6</b>	0.790"	0.940"	0.680"
1"	<b>TN8</b>	1.000"	1.180"	0.930"
1 1/4"	<b>TN10</b>	1.250"	1.500"	1.180"
1 1/2"	<b>TN12</b>	1.500"	1.750"	1.420"
2"	<b>TN16</b>	1.650"	2.220"	1.900"

## BSP male hose adaptor

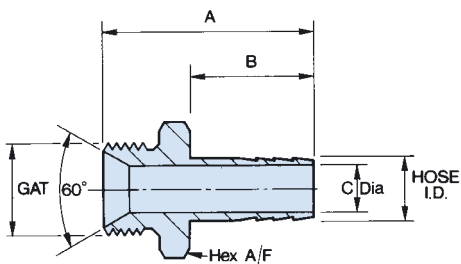

thread size GAT	hose ID	part number	A	B	C dia	hex A/F
1/8" BSP	1/4"	<b>MH2/1</b>	1.700"	1.000"	0.125"	0.750"
1/4" BSP	1/4"	<b>MH2</b>	1.700"	1.000"	0.188"	0.750"
1/4" BSP	3/8"	<b>MH3/2</b>	1.700"	1.000"	0.188"	0.750"
3/8" BSP	3/8"	<b>MH3</b>	1.780"	1.000"	0.312"	0.875"
1/4" BSP	1/2"	<b>MH4/2</b>	1.825"	1.125"	0.188"	0.750"
3/8" BSP	1/2"	<b>MH4/3</b>	1.905"	1.125"	0.312"	0.875"
1/2" BSP	1/2"	<b>MH4</b>	2.000"	1.125"	0.406"	1.125"
1/2" BSP	3/4"	<b>MH6/4</b>	2.412"	1.500"	0.437"	1.125"
3/4" BSP	3/4"	<b>MH6</b>	2.625"	1.500"	0.640"	1.300"
3/4" BSP	1"	<b>MH8/6</b>	2.687"	1.562"	0.687"	1.300"
1" BSP	1"	<b>MH8</b>	2.737"	1.562"	0.875"	1.670"
1 1/4" BSP	1 1/4"	<b>MH10</b>	2.987"	1.750"	1.093"	2.050"
1 1/2" BSP	1 1/2"	<b>MH12</b>	3.375"	2.125"	1.275"	2.220"
2" BSP	2"	<b>MH16</b>	3.687"	2.250"	1.812"	2.750"

## Hose adaptor 60° cone

For use with BSP union nut above

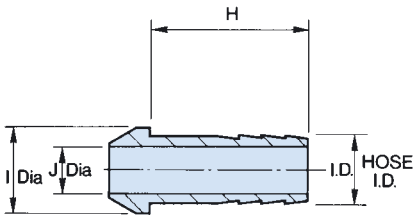

hose ID	part number	H	I dia	J dia
1/4"	HA2	1.000"	0.437"	0.188"
3/8"	HA3	1.125"	0.576"	0.312"
1/2"	HA4	1.312"	0.730"	0.406"
3/4"	HA6	1.500"	0.950"	0.640"
1"	HA8	1.562"	1.188"	0.875"
1 1/4"	HA10	1.750"	1.500"	1.000"
1 1/2"	HA12	2.125"	1.750"	1.281"
2"	HA16	2.250"	2.200"	1.750"

## Hose clips 304 stainless steel

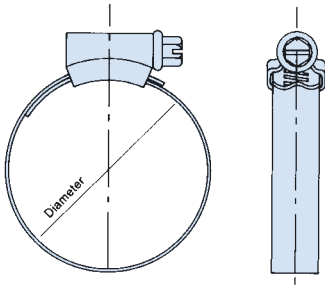

part number	diameter inches
JC 3/4	3/8" - 1/2"
JC 4/6	1/2" - 3/4"
JC 6/8	3/4" - 1"
JC 8/10	1" - 1 1/4"
JC 10/12	1 1/4" - 1 1/2"
JC 12/16	1 1/2" - 2"

## 150LB SCREWED PIPE FITTINGS 316 STAINLESS STEEL

### 90 Degree Elbow

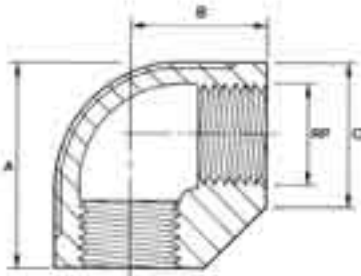

Thread Size BSPP RP	Part Number	Dim A (mm)	Dim B (mm)	Dim C (mm)
1/8"	E1-150	25.5	19	15
1/4"	E2-150	30.5	21	19
3/8"	E3-150	36.5	25	23
1/2"	E4-150	42	28	28
3/4"	E5-150	50	33	34
1"	E6-150	59.5	38	43
1 1/4"	E10-150	71	45	52
1 1/2"	E12-150	78.5	50	57
2"	E16-150	93	58	70

### Street Elbow

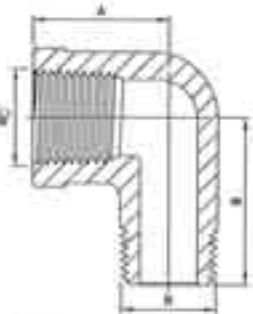

Thread Size BSPT RC x R	Part Number	Dim A (mm)	Dim B (mm)	Dim (mm)
1/8"	SE1-150	17	27	
1/4"	SE2-150	21	28	
3/8"	SE3-150	25	34	
1/2"	SE4-150	28	41	
3/4"	SE5-150	33	46	
1"	SE6-150	38	52	
1 1/4"	SE10-150	43	63	
1 1/2"	SE12-150	48	66	
2"	SE16-150	57	77	

### 45 Degree Elbow

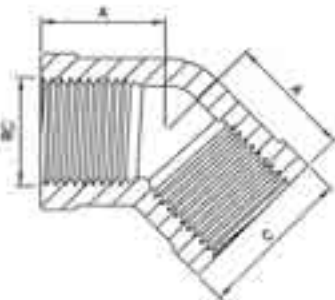

Thread Size BSPT RC	Part Number	Dim A (mm)	Dim C (mm)	Dim (mm)
1/8"	E45/1-150	18	19	
1/4"	E45/2-150	19	19	
3/8"	E45/3-150	21	23	
1/2"	E45/4-150	22	28	
3/4"	E45/6-150	25	37	
1"	E45/8-150	28	45	
1 1/4"	E45/10-150	33	55	
1 1/2"	E45/12-150	36	63	
2"	E45/16-150	43	75	

### Equal Tee

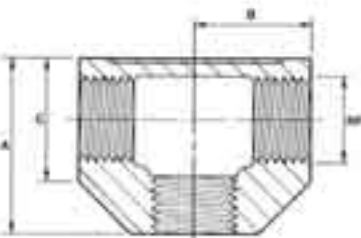

Thread Size BSPP RP	Part Number	Dim A (mm)	Dim B (mm)	Dim C (mm)
1/8"	T1-150	26.5	18	15
1/4"	T2-150	30.5	21	19
3/8"	T3-150	36.5	25	23
1/2"	T4-150	42	28	28
3/4"	T6-150	50	33	34
1"	T8-150	59	38	42
1 1/4"	T10-150	71	45	52
1 1/2"	T12-150	78.5	50	57
2"	T16-150	93	58	70

# 150LB SCREWED PIPE FITTINGS 316 STAINLESS STEEL

## Equal Cross

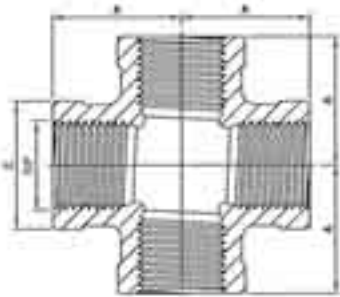

Thread Size BSPP RP	Part Number	Dim A (mm)	Dim C (mm)	Dim (mm)
1/8"	C1-150	19	19	
1/4"	C2-150	21	21	
3/8"	C3-150	25	25	
1/2"	C4-150	28	31	
3/4"	C6-150	33	37	
1"	C8-150	38	45	
1 1/4"	C10-150	45	55	
1 1/2"	C12-150	50	62	
2"	C16-150	58	75	

## Hexagon Nipple

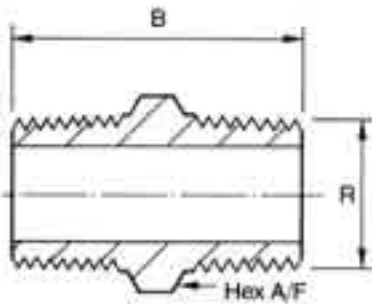

Thread Size BSPT R	Part Number	Dim B (mm)	Dim A/F (mm)	Dim (mm)
1/8"	HN1-150	25	12	
1/4"	HN2-150	32	14	
3/8"	HN3-150	37	20	
1/2"	HN4-150	41	23	
3/4"	HN5-150	46	27	
1"	HN6-150	50	36	
1 1/4"	HN10-150	56	46	
1 1/2"	HN12-150	58	50	
2"	HN16-150	65	65	

## Welding Nipple

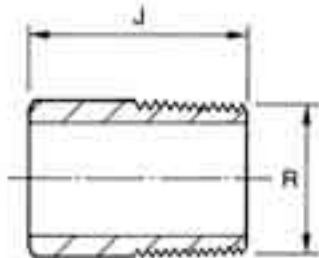

Thread Size BSPT R	Part Number	Dim J (mm)	Dim (mm)	Dim (mm)
1/8"	WN1-150	30		
1/4"	WN2-150	30		
3/8"	WN3-150	30		
1/2"	WN4-150	35		
3/4"	WN6-150	40		
1"	WN6-150	40		
1 1/4"	WN10-150	50		
1 1/2"	WN12-150	50		
2"	WN16-150	50		

## Barrel Nipple

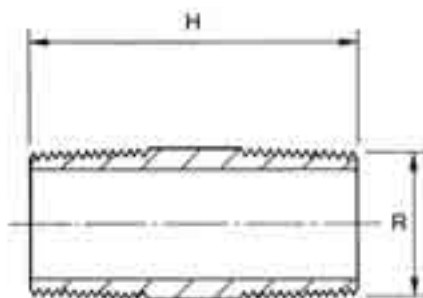

Thread Size BSPT R	Part Number	Dim H (mm)	Dim (mm)	Dim (mm)
1/8"	BN1-150	40		
1/4"	BN2-150	40		
3/8"	BN3-150	40		
1/2"	BN4-150	60		
3/4"	BN6-150	60		
1"	BN6-150	60		
1 1/4"	BN10-150	80		
1 1/2"	BN12-150	80		
2"	BN16-150	100		

## 150LB SCREWED PIPE FITTINGS 316 STAINLESS STEEL

### Parallel Nipple

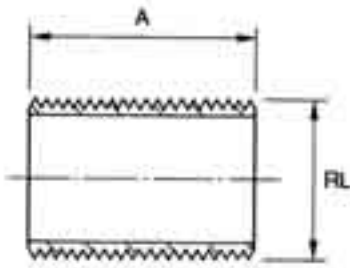

Thread Size BSPP	Part Number	Dim A (mm)	Dim (mm)	Dim (mm)
1/8"	PN1-150	16		
1/4"	PN2-150	18		
3/8"	PN3-150	22		
1/2"	PN4-150	25		
3/4"	PN6-150	30		
1"	PN8-150	35		
1 1/4"	PN10-150	38		
1 1/2"	PN12-150	38		
2"	PN16-150	45		

### Full Socket

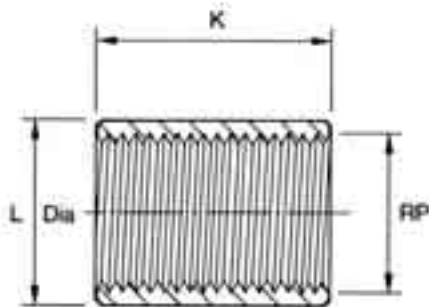

Thread Size BSPP	Part Number	Dim K (mm)	Dim L (mm)	Dim (mm)
1/8"	FS1-150	17	14	
1/4"	FS2-150	25	18	
3/8"	FS3-150	26	22	
1/2"	FS4-150	34	26	
3/4"	FS6-150	36	32	
1"	FS8-150	43	40	
1 1/4"	FS10-150	48	48	
1 1/2"	FS12-150	48	55	
2"	FS16-150	58	66	

### Half Socket

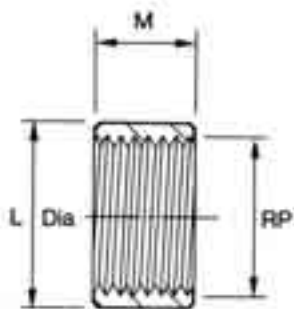

Thread Size BSPP	Part Number	Dim M (mm)	Dim L (mm)	Dim (mm)
1/8"	HS1-150	9	14	
1/4"	HS2-150	12	19	
3/8"	HS3-150	13	22	
1/2"	HS4-150	17	26	
3/4"	HS6-150	18	32	
1"	HS8-150	20	40	
1 1/4"	HS10-150	22	48	
1 1/2"	HS12-150	23	55	
2"	HS16-150	27	66	

### Hexagon Head Plug

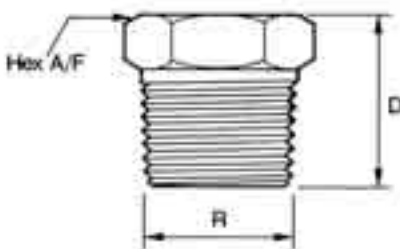

Thread Size BSPT	Part Number	Dim D (mm)	Dim A/F (mm)	Dim (mm)
1/8"	HP1-150	19	12	
1/4"	HP2-150	19	16	
3/8"	HP3-150	19	19	
1/2"	HP4-150	22	23	
3/4"	HP6-150	26	28	
1"	HP8-150	28	36	
1 1/4"	HP10-150	33	46	
1 1/2"	HP12-150	35	50	
2"	HP16-150	39	65	



## 150LB SCREWED PIPE FITTINGS 316 STAINLESS STEEL

### Square Head Plug

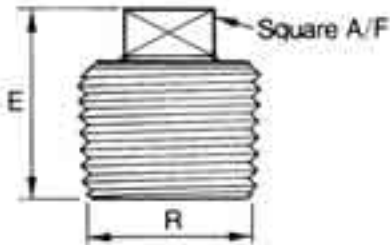

Thread Size BSPT	Part Number	Dim E (mm)	Dim A/F (mm)	Dim (mm)
1/8"	SP1-150	15	7	
1/4"	SP2-150	18	9	
3/8"	SP3-150	20	12	
1/2"	SP4-150	22	14	
3/4"	SP6-150	28	18	
1"	SP8-150	32	19	
1 1/4"	SP10-150	36	23	
1 1/2"	SP12-150	39	26	
2"	SP16-150	45	32	

### Union F/F (Cone Seated)

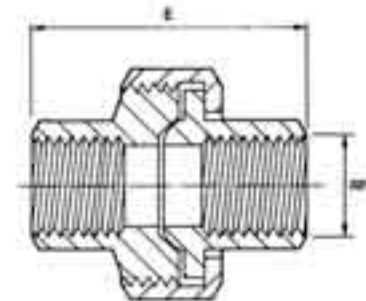

Thread Size BSPP	Part Number	Dim E (mm)	Dim A/F (mm)	Dim (mm)
1/8"	H1-150	40	29	
1/4"	H2-150	42	29	
3/8"	H3-150	45	34	
1/2"	H4-150	48	39	
3/4"	H5-150	52	47	
1"	H6-150	58	58	
1 1/4"	H10-150	65	67	
1 1/2"	H12-150	70	77	
2"	H16-150	78	90	

### Union F/F (Flat Type)

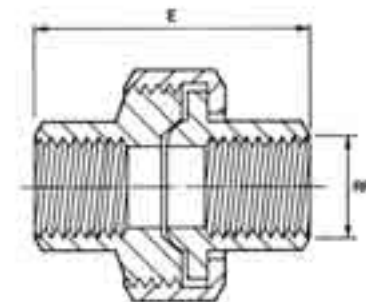

Thread Size BSPP	Part Number	Dim E (mm)	Dim A/F (mm)	Dim (mm)
1/8"	HF1-150	40	29	
1/4"	HF2-150	42	29	
3/8"	HF3-150	45	34	
1/2"	HF4-150	48	39	
3/4"	HF6-150	52	47	
1"	HF8-150	58	58	
1 1/4"	HF10-150	65	67	
1 1/2"	HF12-150	70	77	
2"	HF16-150	78	90	

### Hexagon End Cap

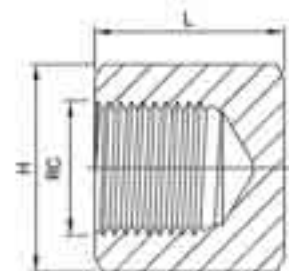

Thread Size BSPT	Part Number	Dim L (mm)	Dim A/F (mm)	Dim (mm)
1/8"	HC1-150	13	15	
1/4"	HC2-150	15	18	
3/8"	HC3-150	18	22	
1/2"	HC4-150	22	26	
3/4"	HC6-150	25	32	
1"	HC8-150	28	39	
1 1/4"	HC10-150	30	48	
1 1/2"	HC12-150	31	54	
2"	HC16-150	38	69	

## 150LB SCREWED PIPE FITTINGS 316 STAINLESS STEEL

### Round End Cap

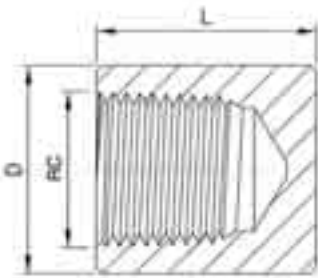

Thread Size BSPT	Part Number	Dim L (mm)	Dim D (mm)	Dim (mm)
RC				
1/8"	EC1-150	17	19	
1/4"	EC2-150	17	21	
3/8"	EC3-150	21	26	
1/2"	EC4-150	23	31	
3/4"	EC6-150	27	37	
1"	EC8-150	33	45	
1 1/4"	EC10-150	41	55	
1 1/2"	EC12-150	41	62	
2"	EC16-150	45	75	

### Hexagon Back Nut

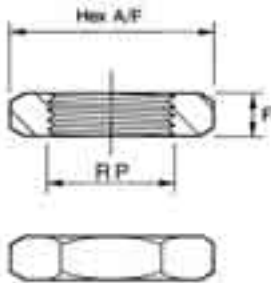

Thread Size BSPP	Part Number	Dim F (mm)	Dim A/F (mm)	Dim (mm)
RP				
1/8"	HBN1-150	6	19	
1/4"	HBN2-150	6	22	
3/8"	HBN3-150	7	27	
1/2"	HBN4-150	8	32	
3/4"	HBN6-150	9	37	
1"	HBN8-150	10	46	
1 1/4"	HBN10-150	11	55	
1 1/2"	HBN12-150	12	62	
2"	HBN16-150	13	76	

### Hose Connector (Nipple)

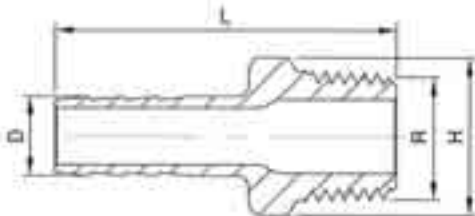

HOSE x BSPT x R	Part Number	Dim L (mm)	Dim H (mm)	Dim D (mm)
1/4" x 1/8"	MH2/1T-150	40	12	7
1/4" x 1/4"	MH2/2T-150	40	15	9
3/8" x 1/4"	MH3/2T-150	40	15	11
1/2" x 1/4"	MH4/2T-150	40	15	11
3/8" x 3/8"	MH3/3T-150	45	19	11
1/2" x 3/8"	MH4/3T-150	50	19	13
1/2" x 1/2"	MH4/4T-150	65	23	13
3/4" x 1/2"	MH6/4T-150	60	23	15
3/4" x 3/4"	MH6/6T-150	63	29	21
1" x 1"	MH8/8T-150	70	38	27
1 1/4" x 1 1/4"	MH10/10T-150	81	46	33
1 1/2" x 1 1/2"	MH12/12T-150	95	52	46
2" x 2"	MH16/16T-150	100	63	57

## 150LB SCREWED PIPE FITTINGS 316 STAINLESS STEEL

### Reducing Adaptor F/M

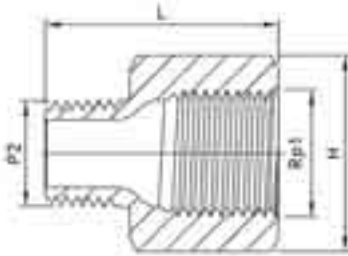

Thread Size BSPT RP1 x P2	Part Number	Dim L (mm)	Dim H (mm)	Dim (mm)
1/4" x 1/8"	RA2/1-150	27	17	
3/8" x 1/4"	RA3/2-150	30	21	
1/2" x 1/4"	RA4/2-150	34	26	
1/2" x 3/8"	RA4/3-150	35	26	
3/4" x 3/8"	RA6/3-150	36	32	
3/4" x 1/2"	RA6/4-150	39	32	
1" x 1/2"	RA8/4-150	42	38	
1" x 3/4"	RA8/6-150	44	38	

### Reducing Socket

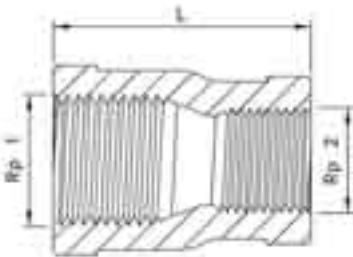

Thread * Size BSPT RP1 x RP2	Part Number	Dim L (mm)	Dim (mm)	Dim (mm)
1/4" x 1/8"	RS2/1-150	27		
3/8" x 1/4"	RS3/2-150	30		
1/2" x 1/4"	RS4/2-150	36		
1/2" x 3/8"	RS4/3-150	36		
3/4" x 1/2"	RS6/4-150	39		
1" x 1/2"	RS8/4-150	45		
1" x 3/4"	RS8/6-150	45		
1 1/4" x 1"	RS10/8-150	51		
1 1/2" x 1 1/4"	RS12/10-150	55		
2" x 1 1/2"	RS16/12-150	55		

## 150LB SCREWED PIPE FITTINGS 316 STAINLESS STEEL

### Hex. Reducing Bush

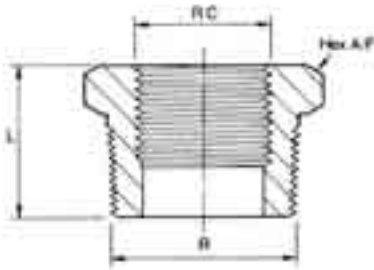

\*Thread Sizes R - BSPT Male,  
G - BSPP Female - See Thread \* Size

Thread Size BSPT	Part Number	Dim L (mm)	Dim A/F (mm)	Dim (mm)
R x RC				
1/4" x 1/8"	HRB2/1-150	19	16	
3/8" x 1/4"	HRB3/2-150	19	19	
1/2" x 1/4"	HRB4/2-150	22	23	
1/2" x 3/8"	HRB4/3-150	22	23	
3/4" x 1/4"	HRB6/2-150	26	28	
3/4" x 3/8"	HRB6/3-150	26	28	
3/4" x 1/2"	HRB6/4-150	26	28	
1" x 1/4"	HRB8/2-150	28	36	
1" x 3/8"	HRB8/3-150	28	36	
1" x 1/2"	HRB8/4-150	28	26	
1" x 3/4"	HRB8/6-150	28	36	
1 1/4" x 3/4"	HRB10/6-150	33	46	
1 1/4" x 1"	HRB10/8-150	33	46	
1 1/2" x 3/4"	HRB12/6-150	35	50	
1 1/2" x 1"	HRB12/8-150	35	50	
1 1/2" x 1 1/4"	HRB12/10-150	35	50	
2" x 1"	HRB16/8-150	39	65	
2" x 1 1/4"	HRB16/10-150	39	65	
2" x 1 1/2"	HRB16/12-150	39	65	

### Hex. Reducing Nipple

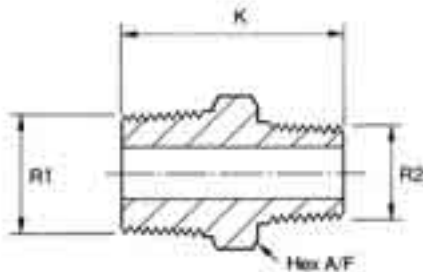

Thread Sizes R - BSPT Male  
See Thread \* Size

Thread Size BSPT	Part Number	Dim K (mm)	Dim A/F (mm)	Dim (mm)
R1 x R2				
1/4" x 1/8"	HRN2/1-150	31	17	
3/8" x 1/8"	HRN3/1-150	35	19	
3/8" x 1/4"	HRN3/2-150	35	19	
1/2" x 1/4"	HRN4/2-150	38	23	
1/2" x 3/8"	HRN4/3-150	38	23	
3/4" x 1/4"	HRN6/2-150	37	29	
3/4" x 3/8"	HRN6/3-150	41	29	
3/4" x 1/2"	HRN6/4-150	41	29	
1" x 1/2"	HRN8/4-150	46	37	
1" x 3/4"	HRN8/6-150	47	37	
1 1/4" x 3/4"	HRN10/6-150	51	46	
1 1/4" x 1"	HRN10/8-150	53	46	
1 1/2" x 3/4"	HRN12/6-150	50	54	
1 1/2" x 1"	HRN12/8-150	55	54	
1 1/2" x 1 1/4"	HRN12/10-150	56	54	
2" x 1"	HRN16/8-150	58	54	
2" x 1 1/4"	HRN16/10-150	63	65	
2" x 1 1/2"	HRN16/12-150	64	65	

**Waverley weld fittings have been designed not only to produce a permanent welded system, but also to be used with the Waverley compression and screwed connections, allowing easy dis-assembly of joints.**

**The Waverley weld fitting range offers a fitting that couples high integrity with strength, the fittings are manufactured from 316 stainless steel. Component materials are traceable, even after many years in service due to the Waverley cast code system.**

## **Features**

Tapered tube socket design, enables you to lock the system together prior to welding (tack welding not required).

Fittings are manufactured to close tolerances for correct installation alignment.

Butt weld ends are produced with standard weld preparation for consistency of welded joints.

Waverley compression/weld fittings enable a component to be easily removed if required.

Sizes range from 1/4" - 1" welded, screwed, single and twin ring compression connections.

High quality bar and forged materials used throughout the range.

All materials conform to ASTM specifications.

Working pressures in accordance with piping code ANS1 B31.1 and refinery piping code ANS1 B31.3.

All threads NPT to ANS1 ASME B1.20.1.1983. Other connection threads available on request.

## Tube socket union

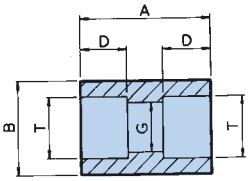

T tube OD	part number	A	B	D	G min	working pressure
1/4"	<b>WTSU-2-SS</b>	0.75"	0.50"	0.28"	0.18"	10241
3/8"	<b>WTSU-3-SS</b>	0.87"	0.62"	0.31"	0.28"	7760
1/2"	<b>WTSU-4-SS</b>	1.06"	0.75"	0.37"	0.40"	6391
3/4"	<b>WTSU-6-SS</b>	1.31"	1.06"	0.43"	0.62"	5521
1"	<b>WTSU-8-SS</b>	1.44"	1.37"	0.62"	0.87"	5055

## Tube socket elbow

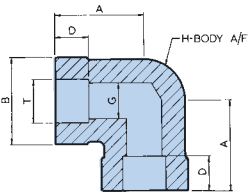

T tube OD	part number	A	B	D	G min	H A/F	working pressure
1/4"	<b>WTSE-2-SS</b>	0.84"	0.62"	0.28"	0.18"	0.50"	12728
3/8"	<b>WTSE-3-SS</b>	0.84"	0.62"	0.31"	0.28"	0.50"	7760
1/2"	<b>WTSE-4-SS</b>	0.97"	0.75"	0.37"	0.40"	0.62"	6391
3/4"	<b>WTSE-6-SS</b>	1.46"	1.25"	0.43"	0.62"	1.06"	7870
1"	<b>WTSE-8-SS</b>	1.59"	1.56"	0.62"	0.87"	1.37"	6969

## Tube socket tee

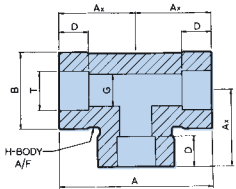

T tube OD	part number	A	B	D	G min	H A/H	working pressure
1/4"	<b>WTST-2-SS</b>	0.84"	0.62"	0.28"	0.18"	0.50"	12728
3/8"	<b>WTST-3-SS</b>	0.84"	0.62"	0.31"	0.28"	0.50"	7760
1/2"	<b>WTST-4-SS</b>	0.97"	0.75"	0.37"	0.40"	0.62"	6391
3/4"	<b>WTST-6-SS</b>	1.46"	1.25"	0.43"	0.62"	1.06"	7870
1"	<b>WTST-8-SS</b>	1.59"	1.56"	0.62"	0.87"	1.37"	6969

## Tube socket male elbow

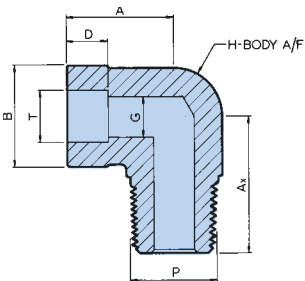

T tube OD	P pipe THRD	part number	A	AX	B	D	G min	H A/F	working pressure
1/4"	1/4"	<b>WTSME-22-SS</b>	0.84"	0.94"	0.62"	0.28"	0.18"	0.50"	12814
1/4"	3/8"	<b>WTSME-23-SS</b>	0.97"	1.13"	0.75"	0.28"	0.18"	0.62"	7587
3/8"	1/4"	<b>WTSME-32-SS</b>	0.84"	0.94"	0.62"	0.31"	0.28"	0.50"	7492
3/8"	3/8"	<b>WTSME-33-SS</b>	0.97"	1.13"	0.75"	0.31"	0.28"	0.62"	7587
1/2"	1/4"	<b>WTSME-42-SS</b>	0.97"	0.97"	0.75"	0.37"	0.28"	0.62"	6391
1/2"	3/8"	<b>WTSME-43-SS</b>	0.97"	1.13"	0.75"	0.37"	0.40"	0.62"	6352
1/2"	1/2"	<b>WTSME-44-SS</b>	1.09"	1.13"	0.93"	0.37"	0.40"	0.81"	9423
3/4"	1/2"	<b>WTSME-64-SS</b>	1.47"	1.13"	1.25"	0.43"	0.50"	1.06"	6415
3/4"	3/4"	<b>WTSME-66-SS</b>	1.47"	1.44"	1.25"	0.43"	0.62"	1.06"	7005
1"	3/4"	<b>WTSME-86-SS</b>	1.59"	1.66"	1.56"	0.62"	0.72"	1.37"	4651
1"	1"	<b>WTSME-88-SS</b>	1.59"	1.86"	1.56"	0.62"	0.87"	1.37"	5170

## Tube socket female elbow

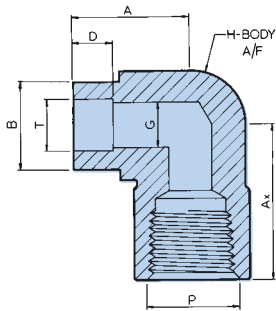

T tube OD	P pipe THRD	part number	A	AX	B	D	G min	H A/F	working pressure
1/4"	1/4"	WTSFE-22-SS	0.96"	1.19"	0.50"	0.28"	0.18"	0.62"	5941
1/4"	3/8"	WTSFE-23-SS	1.09"	1.37"	0.50"	0.28"	0.18"	0.81"	5857
3/8"	1/4"	WTSFE-32-SS	0.96"	1.19"	0.62"	0.31"	0.22"	0.62"	5941
3/8"	3/8"	WTSFE-33-SS	1.09"	1.37"	0.62"	0.31"	0.28"	0.81"	5857
1/2"	1/4"	WTSFE-42-SS	0.97"	1.19"	0.75"	0.37"	0.22"	0.62"	5941
1/2"	3/8"	WTSFE-43-SS	1.09"	1.37"	0.75"	0.37"	0.34"	0.81"	5857
1/2"	1/2"	WTSFE-44-SS	1.46"	1.63"	0.75"	0.37"	0.41"	1.06"	6391
3/4"	1/2"	WTSFE-64-SS	1.46"	1.63"	1.06"	0.43"	0.44"	1.06"	5521
3/4"	3/4"	WTSFE-66-SS	1.59"	1.94"	1.06"	0.43"	0.63"	1.37"	5521
1"	3/4"	WTSFE-86-SS	1.59"	1.94"	1.37"	0.62"	0.63"	1.37"	5055
1"	1"	WTSFE-88-SS	1.78"	2.25"	1.37"	0.62"	0.87"	1.68"	5055

## Tube socket male connector

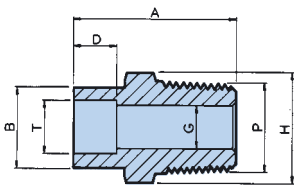

T tube OD	P pipe THRD	part number	A	B	D	G min	H A/F	working pressure
1/4"	1/4"	WTSMC-22-SS	1.19"	0.50"	0.28"	0.18"	0.56"	7492
1/4"	3/8"	WTSMC-23-SS	1.19"	0.50"	0.28"	0.18"	0.75"	4855
3/8"	3/8"	WTSMC-32-SS	1.25"	0.82"	0.31"	0.28"	0.68"	7492
3/8"	3/8"	WTSMC-33-SS	1.25"	0.82"	0.31"	0.28"	0.75"	6352
1/2"	1/4"	WTSMC-42-SS	1.37"	0.75"	0.37"	0.28"	0.87"	6391
1/2"	3/8"	WTSMC-43-SS	1.37"	0.75"	0.37"	0.40"	0.87"	6352
1/2"	1/2"	WTSMC-44-SS	1.59"	0.75"	0.37"	0.40"	0.87"	6391
3/4"	1/2"	WTSMC-64-SS	1.72"	1.06"	0.43"	0.50"	1.12"	5884
3/4"	3/4"	WTSMC-66-SS	1.72"	1.06"	0.43"	0.62"	1.12"	4651
1"	3/4"	WTSMC-86-SS	1.94"	1.37"	0.62"	0.71"	1.50"	4651
1"	1"	WTSMC-88-SS	2.12"	1.37"	0.62"	0.87"	1.50"	5170

## Tube socket female connector

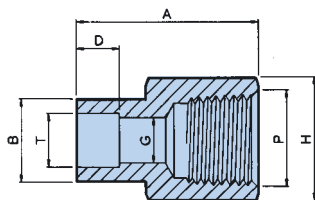

T tube OD	P pipe THRD	part number	A	B	D	G min	H A/F	working pressure
1/4"	1/4"	WTSFC-22-SS	1.09"	0.50"	0.28"	0.18"	0.75"	5941
1/4"	3/8"	WTSFC-23-SS	1.15"	0.50"	0.28"	0.18"	0.87"	4855
3/8"	1/4"	WTSFC-32-SS	1.15"	0.62"	0.31"	0.21"	0.75"	5941
3/8"	3/8"	WTSFC-33-SS	1.21"	0.62"	0.31"	0.28"	0.87"	4855
1/2"	1/4"	WTSFC-42-SS	1.25"	0.75"	0.37"	0.21"	0.87"	5941
1/2"	3/8"	WTSFC-43-SS	1.31"	0.75"	0.37"	0.34"	0.87"	4855
1/2"	1/2"	WTSFC-44-SS	1.50"	0.75"	0.37"	0.40"	1.12"	5315
3/4"	3/4"	WTSFC-66-SS	1.62"	1.06"	0.43"	0.43"	0.12"	4200
1"	3/4"	WTSFC-86-SS	1.71"	1.37"	0.62"	0.62"	1.50"	4200
1"	1"	WTSFC-88-SS	1.90"	1.37"	0.62"	0.78"	1.68"	4660

## Pipe to tube adaptor

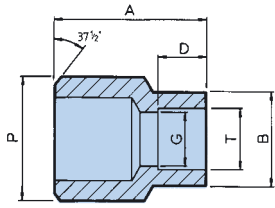

P pipe NB	T tube OD	part number	A	B	D	G	working min pressure
1/4"	1/4"	<b>WPTA-22-SS</b>	0.94"	0.50"	0.28"	0.18"	9731
3/8"	3/8"	<b>WPTA-33-SS</b>	1.00"	0.62"	0.31"	0.28"	7760
1/2"	1/2"	<b>WPTA-44-SS</b>	1.28"	0.75"	0.37"	0.40"	6391
3/4"	1/2"	<b>WPTA-66-SS</b>	1.41"	1.06"	0.43"	0.62"	5521
1"	1"	<b>WPTA-88-SS</b>	1.66"	1.37"	0.62"	0.87"	5055

## Tube socket reducer

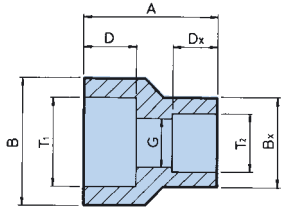

T1 tube OD	T2 tube OD	part number	A	B	Bx	D	Dx	G	working min pressure
3/8"	1/4"	<b>WTSR-23-SS</b>	1.82"	0.62"	0.50"	0.31"	0.28"	0.18"	7760
1/2"	1/4"	<b>WTSR-42-SS</b>	0.91"	0.75"	0.50"	0.31"	0.28"	0.18"	6391
1/2"	3/8"	<b>WTSR-64-SS</b>	0.97"	0.75"	0.62"	0.37"	0.31"	0.28"	6391
3/4"	1/2"	<b>WTSR-84-SS</b>	1.91"	1.06"	0.75"	0.44"	0.37"	0.40"	5521
1"	1/2"	<b>WTSR-84-SS</b>	1.25"	1.37"	0.75"	0.62"	0.37"	0.40"	5055
1"	3/4"	<b>WTSR-86-SS</b>	1.38"	1.37"	1.06"	0.62"	0.43"	0.62"	5055

## Pipe socket union

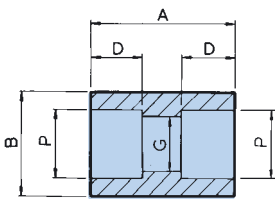

P pipe NB	part number	A	B	D	G	working pressure
1/4"	<b>WPSU-2-SS</b>	1.06"	0.98"	0.38"	0.41"	9250
3/8"	<b>WPSU-3-SS</b>	1.12"	1.11"	0.44"	0.50"	7820
1/2"	<b>WPSU-4-SS</b>	1.12"	1.36"	0.50"	0.73"	7662
3/4"	<b>WPSU-6-SS</b>	1.75"	1.48"	0.62"	1.06"	5404
1"	<b>WPSU-8-SS</b>	1.75"	1.86"	0.62"	1.06"	5571

## Tube compression to tube socket connector

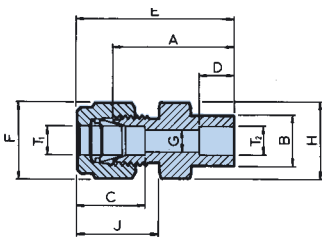

T1 tube OD	T2 tube OD	part number	A	B	C	D	E	F A/F	G min	H A/F	J
1/4"	1/4"	<b>WRTSC-22-SS</b>	1.00"	0.50"	0.61"	0.28"	1.30"	0.56"	0.18"	0.56"	0.70"
1/4"	3/8"	<b>WRTSC-23-SS</b>	1.09"	0.62"	0.61"	0.31"	1.39"	0.56"	0.18"	0.75"	0.70"
3/8"	3/8"	<b>WRTSC-33-SS</b>	1.16"	0.62"	0.67"	0.31"	1.45"	0.68"	0.28"	0.75"	0.76"
3/8"	1/2"	<b>WRTSC-34-SS</b>	1.28"	0.75"	0.67"	0.38"	1.58"	0.68"	0.28"	0.87"	0.76"
1/2"	1/2"	<b>WRTSC-44-SS</b>	1.28"	0.75"	0.91"	0.38"	1.69"	0.87"	0.40"	0.87"	0.87"
1/2"	3/4"	<b>WRTSC-46-SS</b>	1.44"	1.06"	0.91"	0.44"	1.84"	0.87"	0.40"	1.12"	0.87"
3/4"	3/4"	<b>WRTSC-66-SS</b>	1.44"	1.06"	0.97"	0.44"	1.84"	1.12"	0.62"	1.12"	0.87"
3/4"	1"	<b>WRTSC-68-SS</b>	1.65"	1.37"	0.97"	0.62"	2.06"	1.12"	0.62"	1.50"	0.87"
1"	1"	<b>WRTSC-88-SS</b>	1.75"	1.37"	1.27"	0.62"	2.26"	1.50"	0.87"	1.50"	1.08"



## Tube compression to pipe butt connector

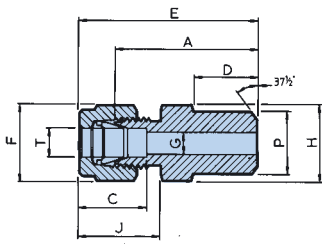

T1 tube OD	P pipe NB	part number	A	C	D	E	F A/F	G min	H A/F	J
1/4"	1/4"	<b>WRPBC-22-SS</b>	1.19"	0.61"	0.56"	1.52"	0.56"	0.18"	0.68"	0.70"
1/4"	3/8"	<b>WRPBC-23-SS</b>	1.22"	0.61"	0.56"	1.52"	0.56"	0.18"	0.75"	0.70"
3/8"	3/8"	<b>WRPBC-33-SS</b>	1.28"	0.67"	0.56"	1.58"	0.68"	0.28"	0.75"	0.76"
3/8"	1/2"	<b>WRPBC-34-SS</b>	1.50"	0.67"	0.75"	1.80"	0.68"	0.28"	0.87"	0.76"
1/2"	1/2"	<b>WRPBC-44-SS</b>	1.50"	0.91"	0.75"	1.19"	0.87"	0.40"	0.87"	0.87"
1/2"	3/4"	<b>WRPBC-46-SS</b>	1.53"	0.91"	0.75"	1.94"	0.87"	0.40"	1.12"	0.87"
3/4"	3/4"	<b>WRPBC-66-SS</b>	1.53"	0.97"	0.75"	1.94"	1.12"	0.62"	1.12"	0.87"
3/4"	1"	<b>WRPBC-68-SS</b>	1.87"	0.97"	0.94"	2.28"	1.12"	0.62"	1.50"	0.87"
1"	1"	<b>WRPBC-88-SS</b>	1.97"	1.27"	0.94"	2.48"	1.50"	0.87"	1.50"	1.08"

## Tube compression to tube socket elbow

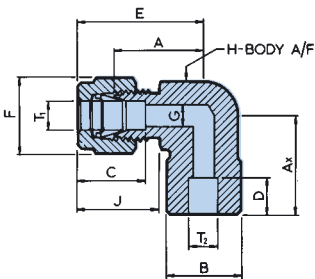

T1 tube OD	T2 tube OD	part number	A	Ax	B	C	D	E	F A/F	G min	H A/F	J
1/4"	1/4"	<b>WRTSE-22-SS</b>	0.77"	0.84"	0.62"	0.61"	0.28"	1.07"	0.56"	0.18"	0.50"	0.70"
1/4"	3/8"	<b>WRTSE-23-SS</b>	0.77"	0.87"	0.62"	0.61"	0.31"	1.07"	0.56"	0.18"	0.50"	0.70"
3/8"	3/8"	<b>WRTSE-33-SS</b>	0.91"	0.96"	0.75"	0.67"	0.31"	1.12"	0.68"	0.28"	0.62"	0.76"
3/8"	1/2"	<b>WRTSE-34-SS</b>	0.91"	1.00"	0.75"	0.67"	0.37"	1.12"	0.68"	0.28"	0.62"	0.76"
1/2"	1/2"	<b>WRTSE-44-SS</b>	1.02"	1.09"	0.93"	0.91"	0.37"	1.43"	0.87"	0.40"	0.81"	0.87"
1/2"	3/4"	<b>WRTSE-46-SS</b>	1.02"	1.46"	1.25"	0.91"	0.43"	1.43"	0.87"	0.40"	1.06"	0.87"
3/4"	3/4"	<b>WRTSE-66-SS</b>	1.17"	1.46"	1.25"	0.97"	0.43"	1.58"	1.12"	0.62"	1.06"	0.87"
3/4"	1"	<b>WRTSE-68-SS</b>	1.36"	1.59"	1.56"	0.97"	0.62"	1.77"	1.12"	0.62"	1.37"	1.08"
1"	1"	<b>WRTSE-88-SS</b>	1.45"	1.59"	1.56"	1.27"	0.62"	1.97"	1.50"	0.87"	1.37"	1.08"

## Tube compression to pipe butt elbow

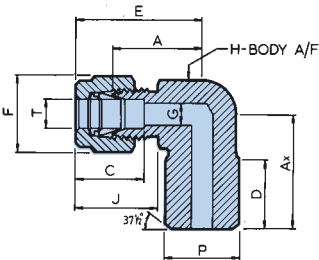

T1 tube OD	P pipe NB	part number	A	Ax	C	D	E	F A/F	G min	H A/F	J
1/4"	1/4"	<b>WRPBE-22-SS</b>	0.77"	1.00"	0.61"	0.56"	1.07"	0.56"	0.18"	0.50"	0.70"
1/4"	3/8"	<b>WRPBE-23-SS</b>	0.77"	1.06"	0.61"	0.56"	1.07"	0.56"	0.18"	0.62"	0.70"
3/8"	3/8"	<b>WRPBE-34-SS</b>	0.91"	1.06"	0.67"	0.56"	1.12"	0.68"	0.28"	0.62"	0.76"
3/8"	1/2"	<b>WRPBE-44-SS</b>	0.91"	1.34"	0.67"	0.75"	1.12"	0.68"	0.28"	0.81"	0.76"
1/2"	1/2"	<b>WRPBE-44-SS</b>	1.02"	1.34"	0.91"	0.75"	1.43"	0.87"	0.40"	0.81"	0.87"
1/2"	3/4"	<b>WRPBE-46-SS</b>	1.02"	1.50"	0.91"	0.75"	1.43"	0.87"	0.40"	1.06"	0.87"
3/4"	3/4"	<b>WRPBE-66-SS</b>	1.17"	1.50"	0.97"	0.75"	1.58"	1.12"	0.62"	1.06"	0.87"
3/4"	1"	<b>WRPBE-68-SS</b>	1.36"	1.90"	0.97"	0.93"	1.77"	1.12"	0.62"	1.37"	0.87"
1"	1"	<b>WRPBE-88-SS</b>	1.45"	1.90"	1.27"	0.93"	1.97"	1.50"	0.87"	1.37"	1.08"

# OTHER WAVERLEY BROWNALL PRODUCTS

Our wide product range offers you everything from complete instrumentation packages to a one off requirement. Experience with supplying customer specials means that we can effectively source complementary products or meet your requirements from our specials design and manufacturing operation.

In addition to our standard range of 316 stainless steel products; we offer compression fittings in monel and other exotic metals.

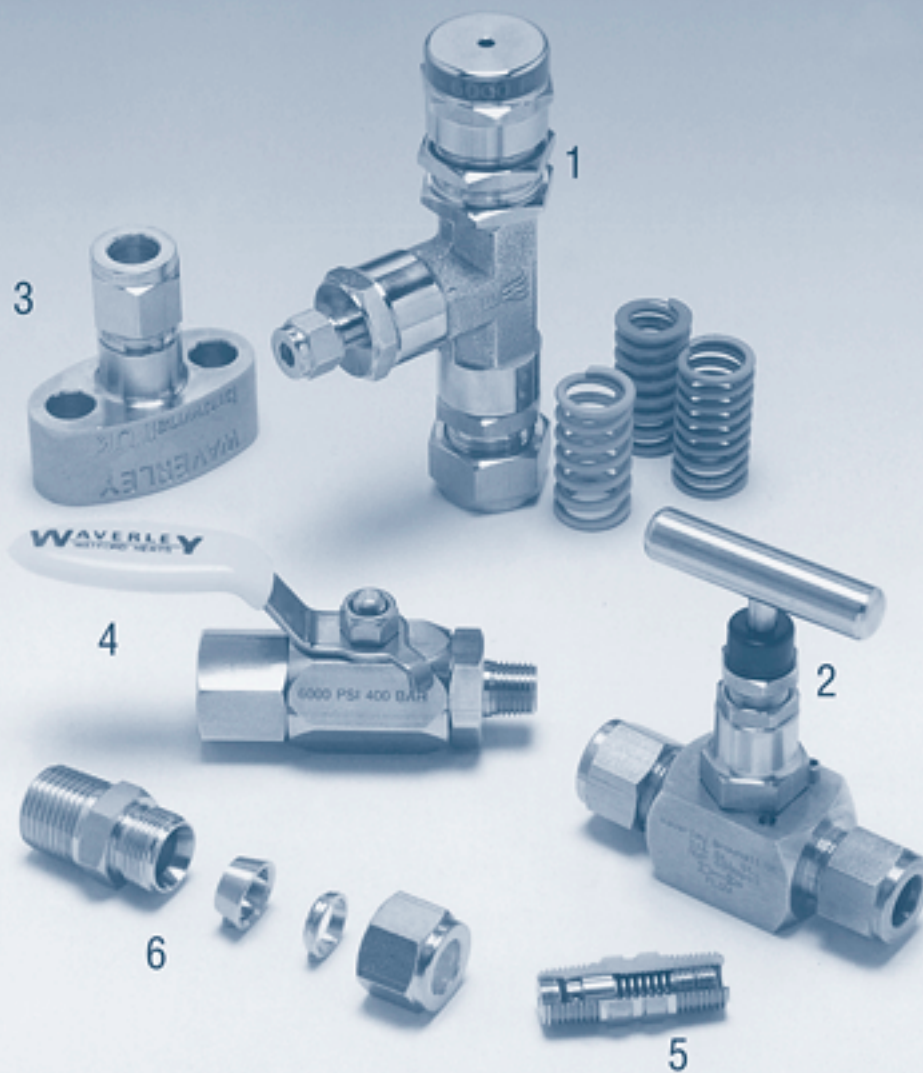

1. Relief valves with a full range of end connections
2. Needle valves up to 10,000 psi
3. Duoloc and Ringlok Flange fittings
4. Ball valves up to 6,000 psi
5. Mini check valves
6. Ringlok twin ferrule compression fittings

**Waverley brownall**



## Ring Binder Book

The complete Waverley brownall range is also shown in detail in a ring binder for ease of reference.

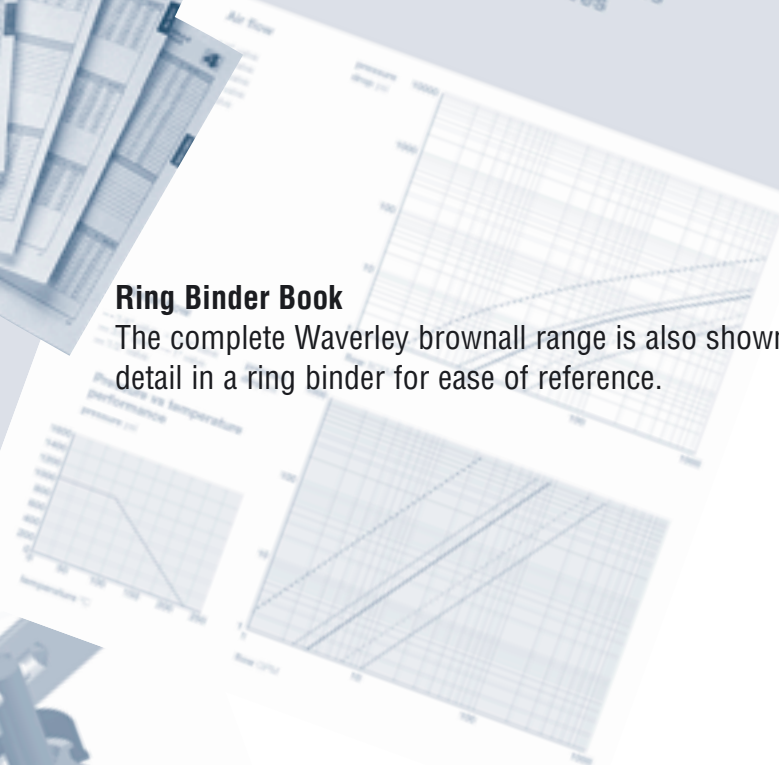

## Electronic Catalogue

The Waverley brownall electronic catalogue offers you a fast and accurate means of selecting the right 316 stainless steel fittings and valves for your instrumentation applications.



## Compact Product Catalogue

Gives a complete overview of our entire range.



Waverley brownall Ltd  
46, The Vintners, Temple Farm Industrial Estate  
Southend-on-Sea, Essex SS2 5RZ  
Tel: +44 (0)1702 600014  
Fax: +44 (0)1702 613600  
email: [sales@waverleybrownall.co.uk](mailto:sales@waverleybrownall.co.uk)  
[www.waverleybrownall.co.uk](http://www.waverleybrownall.co.uk)  
Waverley brownall Scotland  
Tel: +44 (0)1224 877323